

Noise Tools 1U

Clock, Random Pulse, Analog Noise, Sample & Hold, and Slew

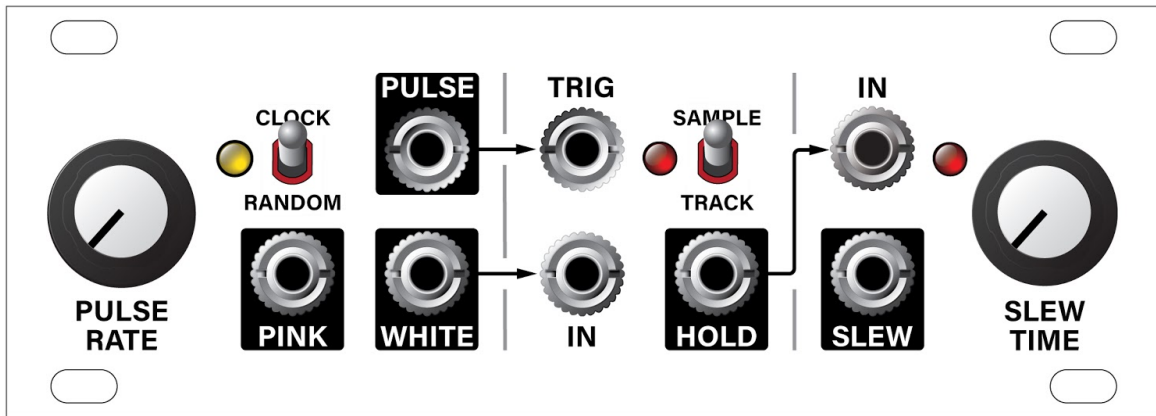

Table of Contents

[Table of Contents](#)

[Compliance](#)

[Installation](#)

[Before Your Start](#)

[Installing Your Module](#)

[Overview](#)

[Front Panel](#)

[Controls](#)

[Inputs and Outputs](#)

[Technical Specifications](#)

Compliance



This device complies with Part 15 of the FCC Rules. Operation is subject to the following two conditions: (1) this device may not cause harmful interference, and (2) this device must accept any interference received, including interference that may cause undesired operation.

Changes or modifications not expressly approved by Intellijel Designs, Inc. could void the user's authority to operate the equipment.

Any digital equipment has been tested and found to comply with the limits for a Class A digital device, pursuant to part 15 of the FCC Rules. These limits are designed to provide reasonable protection against harmful interference when the equipment is operated in a commercial environment. This equipment generates, uses, and can radiate radio frequency energy and, if not installed and used in accordance with the instruction manual, may cause harmful interference to radio communications.



This device meets the requirements of the following standards and directives:

EMC: 2014/30/EU

EN55032:2015 ; EN55103-2:2009 (EN55024) ; EN61000-3-2 ; EN61000-3-3

Low Voltage: 2014/35/EU

EN 60065:2002+A1:2006+A11:2008+A2:2010+A12:2011

RoHS2: 2011/65/EU

WEEE: 2012/19/EU

Installation

This module is designed for use within an Intellijel-standard 1U row, such as contained within the Intellijel 4U and 7U Eurorack cases. Intellijel's 1U specification is derived from the Eurorack mechanical specification set by Doepfer that is designed to support the use of lipped rails within industry standard rack heights.

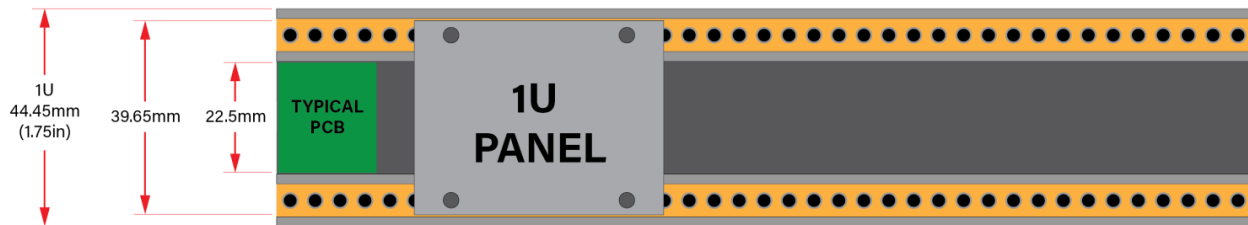
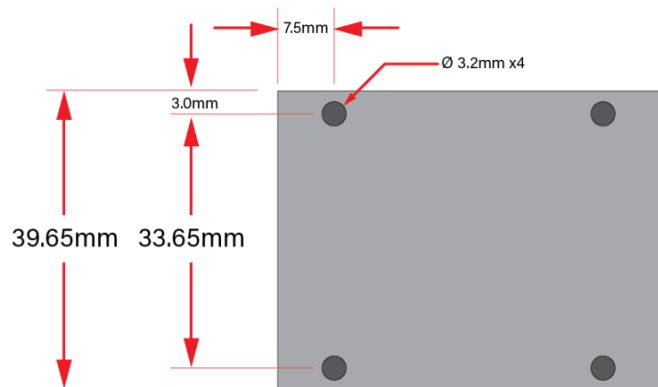

Before Your Start

Intellijel Eurorack modules are designed to be used with a Eurorack-compatible case and power supply. We recommend you use Intellijel cases and power supplies.

Before installing a new module in your case, you must ensure your power supply has a free power header and sufficient available capacity to power the module:

- Sum up the specified +12V current draw for all modules, including the new one. Do the same for the -12 V and +5V current draw. The current draw will be specified in the manufacturer's technical specifications for each module.
- Compare each of the sums to specifications for your case's power supply.
- Only proceed with installation if none of the values exceeds the power supply's specifications. Otherwise you must remove modules to free up capacity or upgrade your power supply.

You will also need to ensure your case has enough free space (hp) to fit the new module. To prevent screws or other debris from falling into the case and shorting any electrical contacts, not leave gaps between adjacent modules, and cover all unused areas with blank panels. Similarly, do not use open frames or any other enclosure that exposes the backside of any module or the power distribution board.

You can use a tool like [ModularGrid](#) to assist in your planning. Failure to adequately power your modules may result in damage to your modules or power supply. If you are unsure, please [contact us](#) before proceeding.

Installing Your Module

When installing or removing a module from your case always turn off the power to the case and disconnect the power cable. Failure to do so may result in serious injury or equipment damage.

Ensure the 10-pin connector on the power cable is connected correctly to the module before proceeding. The red stripe on the cable must line up with the -12V pins on the module's power connector. The pins are indicated with the label -12V, a white stripe next to the connector, the words "red stripe", or some combination of those indicators.

Most modules will come with the cable already connected but it is good to double check the orientation. Be aware that some modules may have headers that serve other purposes so ensure the cable is connected to the right one.

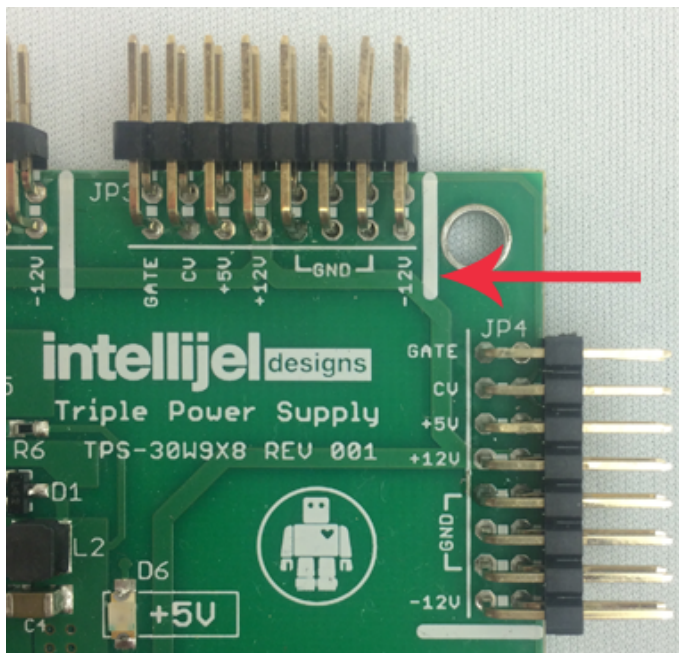
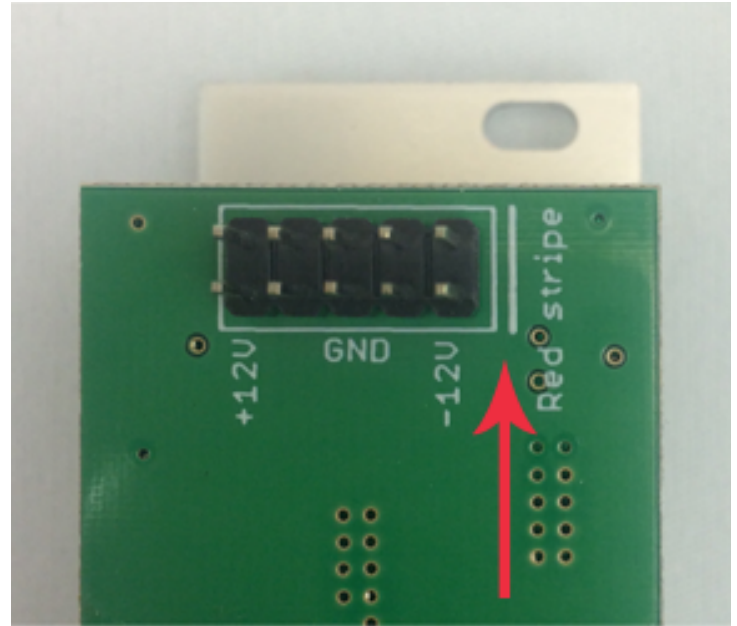

The other end of the cable, with a 16-pin connector, connects to the power bus board of your Eurorack case. Ensure the red stripe on the cable lines up with the -12V pins on the bus board. On Intellijel power supplies the pins are labelled with the label "-12V" and a thick white stripe:

If you are using another manufacturer's power supply, check their documentation for instructions.

Once connected, the cabling between the module and power supply should resemble the picture below:

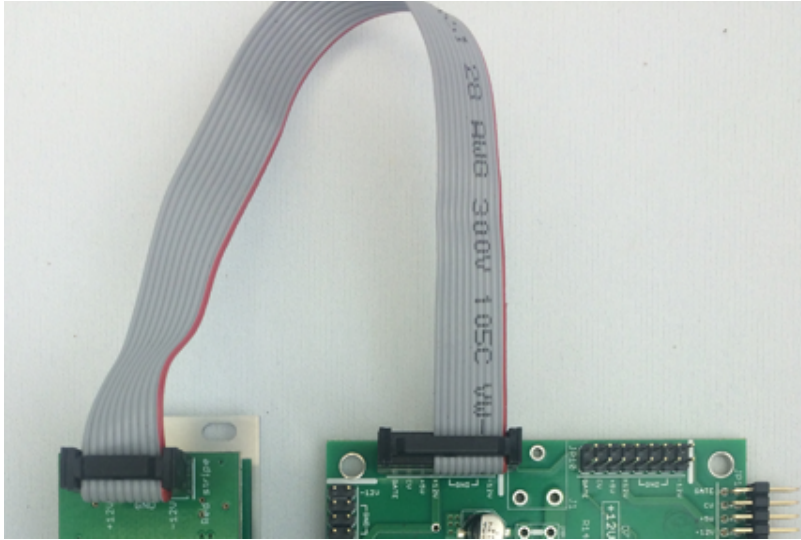

Before reconnecting power and turning on your modular system, double check that the ribbon cable is fully seated on both ends and that all the pins are correctly aligned. If the pins are misaligned in any direction or the ribbon is backwards you can cause damage to your module, power supply, or other modules.

After you have confirmed all the connections, you can reconnect the power cable and turn on your modular system. You should immediately check that all your modules have powered on and are functioning correctly. If you notice any anomalies, turn your system off right away and check your cabling again for mistakes.

After you have confirmed all the connections, you can reconnect the power cable and turn on

Overview

Noise Tools collects and connects a number of practical modular synthesis utilities beneath a single 1U, 22 hp panel. Specifically, it contains:

- A clock and random pulse source with adjustable rate
- Analog pink and white noise source with very accurate spectrum
- Analog sample / track and hold with very low droop
- Analog slew with adjustable slew rate

Most people consider noise to be “undesirable,” and product developers expend great effort to design circuits that minimize noise. So why would anyone want to own Noise Tools — a module designed specifically to *create* noise?

Indeed, *unwanted* noise is undesirable. But not all noise is unwanted. Synthesizing the sound of wind or waves are a couple of the more obvious uses for a noise generator, but the possibilities go far beyond. The crack of a snare hit; the breathiness of a flute sound; an added sizzle to a resonant pad — all are within the sonic domain of noise.

But noise has many other benefits beyond simply being heard. Noise happens to make a wonderful modulator. When noise is used to modulate a filter’s cutoff frequency, or an oscillator’s pitch or pulse width, then all sorts of raspy, buzzy, gritty timbres are obtained.

Noise is also a key ingredient in sample & hold circuits, so one is included in Noise Tools. Sample & Hold (S&H) is a technique most commonly used to generate stepped, random voltages. The circuit works by (you guessed it) sampling an input signal’s voltage each time you send it a clock pulse, and holding that voltage until the next clock pulse. So, naturally, Noise Tools also contains the requisite clocking tools! Two of the most common destinations for the S&H output are a filter’s cutoff frequency (creating stepped, clocked timbral changes), and the VCO frequency (which produces random notes at clocked intervals).

Of course, you might not always want your voltages to change so abruptly at each clock pulse. Maybe you’d prefer they wobble about gradually and with more grace? To do that, you need a slew circuit, and once again Noise Tools has you covered.

With all these features, plus the ability to create random pulses, clock to external pulses, perform more esoteric track & hold duties, and slew external voltages, Noise Tools far exceeds the capabilities suggested by its humble name or its tiny 1U form factor.

Front Panel

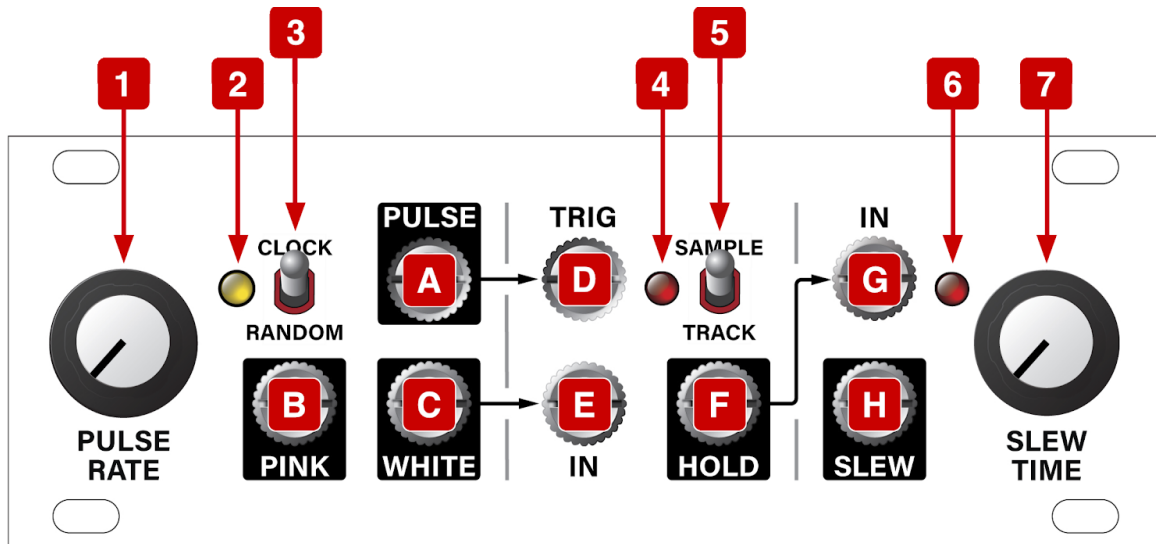

Controls

1. **PULSE RATE** - Sets the rate at which pulses appear at the PULSE output and (unless you plug an external clock into the TRIG input) determines the sampling/tracking clock rate of the sample & hold circuit.

The scale of the Pulse Rate knob changes depending on whether Noise Tools is in CLOCK mode or RANDOM mode.

In CLOCK mode, the knob sweeps from a 15 sec clock pulse at the minimum (counter-clockwise) setting, through standard “tempo” range clocks in the middle of the sweep, to audio rate pulses that top out at 2.5 kHz at the maximum (clockwise) setting.

In RANDOM mode, the knob sets the probability that Noise Tools will generate a pulse. Internally, Noise Tools generates a pulse every 10 ms, with the knob determining how likely that pulse will be passed to the output. When the knob is set to lower (counter clockwise) values, most pulses are filtered out and individual pulses can be easily perceived, creating a sort of “morse-code” effect. At higher values, the random pulses occur more frequently, resulting in something more akin to “static.”

2. **PULSE LED** - Lights when Noise Tools’ internal pulse is high (+5 V).

- 3. CLOCK/RANDOM** - Sets whether or not the internal clock generates pulses at a steady, metrical rate; or whether it generates pulses at random intervals. The rate at which either mode generates pulses is set by the PULSE RATE knob, described earlier.

- 4. INPUT LED** - Lights when an Input signal is present at the SAMPLE IN jack.

The LED lights green if the input voltage is positive, and red if it's negative. The brightness of the LED indicates the voltage value, with a brighter LED denoting a greater absolute input voltage.

- 5. SAMPLE/TRACK** - Sets whether Noise Tools functions as a Sample & Hold circuit or as a Track & Hold circuit.

When switched to SAMPLE, Noise Tools operates as a traditional sample & hold — sampling the SAMPLE IN voltage at the rising edge of each pulse and holding that sampled voltage steady until the next rising pulse edge. This creates a new static voltage every pulse, which Noise Tools sends out the HOLD jack.

When set to the TRACK position, Noise Tools samples the SAMPLE IN voltage at the falling edge of each pulse, and holds that sampled voltage only for as long as the pulse remains low. When the pulse is high, the SAMPLE IN voltage transmits through to the output unaffected.

Track & hold provides a rather interesting alternative to the more familiar sound of the sample & hold circuit. Although it loses that stepped, static output signal that's so effective feeding an oscillator's pitch input, it gains a less certain (and perhaps more interesting) semi-rhythmic control signal for modulating other parameters in some truly unique ways.

- 6. SLEW OUT LED** - Lights to indicate the presence of a slew output voltage.

The LED lights green if the slew voltage is positive, and red if it's negative. The brightness of the LED indicates the value of voltage, with a brighter LED denoting a greater absolute output voltage.

7. **SLEW TIME** - Sets how quickly (or slowly) the output voltage responds to a change in input voltage, thus converting any instantaneous voltage changes appearing at the SLEW IN to a gradual “slewed” voltage change at the SLEW OUT.

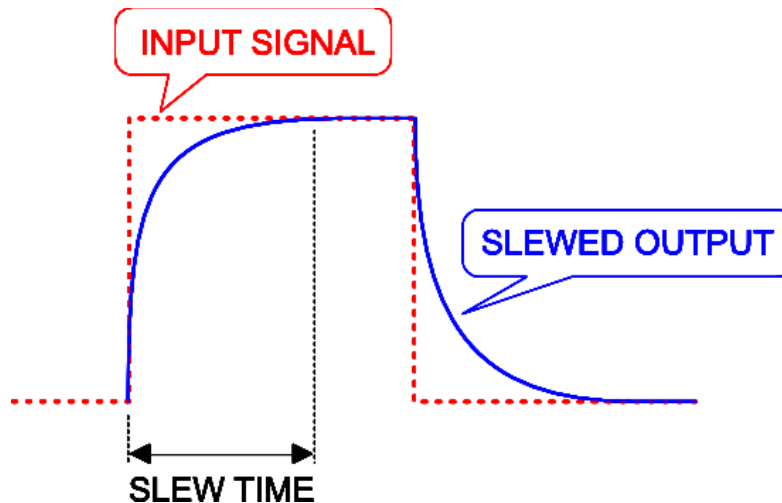

Slew times range from nearly instantaneous at the knob's minimum (counter-clockwise) position to a maximum of about 1 second for a 5V change.

Inputs and Outputs

- A. **PULSE** - Outputs the Pulse signal (5 V gate) generated by Noise Tools' internal pulse circuit.
- B. **PINK** - Pink noise output.

Pink noise has less high frequency energy than white noise, and thus sounds “darker.” Pink noise contains equal power per *octave*, which means the 55Hz wide range of frequencies in the octave between A1 and A2 contains the same amount of energy as the 880Hz range of frequencies in the octave between A5 and A6. This has the effect of giving more sonic weight to lower frequencies, resulting in a deeper, thicker sounding noise.

- C. **WHITE** - White noise output.

White noise contains equal power per *frequency*, which means every frequency, whether it's 70Hz or 7,000Hz is equally present in the noise signal, and the energy curve is not skewed toward the lower frequencies favored by pink noise. This gives white noise more brightness and sizzle than pink noise.

D. TRIG - A pulse sent here determines the rate at which the signal appearing at the SAMPLE IN jack is sampled (or tracked). If nothing is plugged into the TRIG input, then Noise Tools uses its own internal Pulse generator as the TRIG signal.

E. SAMPLE IN - Input signal to be sampled (or tracked) by the sample & hold (S&H) circuit. Any signal appearing at this input is sampled every time Noise Tools receives a pulse (either from its internal Pulse generator or via the TRIG input).

If nothing is plugged into the SAMPLE IN jack, then Noise Tools' WHITE noise output is used as the sample source. White noise produces the widest range of random values when sampled by a sample & hold circuit. If you want a more subdued set of random values that skews toward lower frequencies, you can patch the PINK noise output into the SAMPLE IN jack.

Any type of signal (not just noise) can be sampled. For example, assume you clock a slow LFO with a division of the same pulse you send to the TRIG input. If you then send that LFO to the SAMPLE IN jack and connect the HOLD out to an oscillator's pitch input, you'll hear a repeating arpeggiated sequence, rather than the random stream of notes you'd hear if you sampled noise.

Another interesting way to use the SAMPLE IN feature is to feed it an audio signal (such as the output of an oscillator), then adjust the clock rate to get varying "bit crush" effects from the HOLD output.

F. HOLD - Outputs the sampled (or tracked) signal generated by the sample & hold circuit.

G. SLEW IN - Input for the signal you wish to slew.

If nothing is plugged into the SLEW IN, Noise Tools routes the HOLD output of the sample & hold circuit through the slew, creating a "smoother" copy of the stepped output that appears at the HOLD output.

If you plug some other voltage source into the SLEW IN, then the HOLD output is disconnected and the circuit slews the connected input voltage instead. You can achieve a portamento effect if you plug the pitch output of a keyboard or sequencer into the SLEW IN, then adjust the SLEW TIME knob to achieve the desired portamento speed.

H. SLEW OUT - Outputs the slewed version of the signal appearing at the SLEW IN jack. If nothing is connected to SLEW IN, then this jack outputs a slewed version of the HOLD output.

Technical Specifications

Width	22 hp
Maximum Depth	25 mm
Current Draw	20 mA @ +12V 15 mA @ -12V