



*User's Manual*

# *altea active series*



Antes de utilizar el equipo, lea la sección "Precauciones de seguridad" de este manual. Conserve este manual para futuras consultas. Before operating the device, please read the "Safety precautions" section of this manual. Retain this manual for future reference.

## CONTENTS

<b>SAFETY PRECAUTIONS</b>	<b>3</b>
<b>WARRANTY</b>	<b>4</b>
<b>DECLARATION OF CONFORMITY</b>	<b>5</b>
<b>INTRODUCTION</b>	<b>6</b>
<b>CONFIGURATIONS</b>	<b>7 - 12</b>
<u>2 x altea 712A (wireless audio)</u>	
<u>2 x altea 715A (wireless audio)</u>	
<u>2 x altea 412A/712A</u>	
<u>2 x altea 415A/715A</u>	
<u>2 x altea 412A/712A + 1 x vantec-18A</u>	
<u>2 x altea 415A/715A + 2 x vantec-18A</u>	
<b>LINE DRAWINGS</b>	<b>13</b>
<b>SPECIFICATIONS</b>	<b>14</b>
<b>AMPLIFIER</b>	<b>15 - 16</b>
<u>Description</u>	
On / Off	
Overload (limit&input clip) indicators	
Equalisation	
Overheating	
Low mains voltage	
Current consumption	
<b>DISPLAY</b>	<b>17 - 19</b>
Adjusting the levels	
Main Menu	
System presets (Live, dance, Bboost, Monitor, Vocals)	
HPF (High Pass Filter)	
EQ Low / Mid / High	
Delay	
Options	
<b>WIRELESS CONNECTIVITY (Audio &amp; DASlink)</b>	<b>20</b>
<b>TROUBLESHOOTING</b>	<b>21</b>
<b>RIGGING SYSTEM</b>	<b>22 - 23</b>
<b>APPENDIX</b>	<b>24</b>
<u>Line connections: unbalanced and balanced</u>	



El signo de exclamación dentro de un triángulo indica la existencia de importantes instrucciones de operación y mantenimiento en la documentación que acompaña al producto. Conserve y lea todas estas instrucciones. Siga las advertencias. ATENCIÓN: Es un producto clase A, por lo que en entornos domésticos puede causar radio-interferencias, en cuyo caso el usuario tendrá que tomar las medidas oportunas. De acuerdo con EN55103-2, usar el equipo sólo en entornos E1, E2, E3 ó E4.



The exclamation point inside an equilateral triangle is intended to alert the users to the presence of important operating and maintenance (servicing) instructions in the literature accompanying the product. Heed all warnings. Follow all instructions. Keep these instructions.

WARNING: This is a class A product. In a domestic environment this product may cause radio interferences in which case the user may be required to take adequate measures. Use this product only in E1, E2, E3 or E4 environments according to EN55103-2.

No desconecte la tierra en el conector de alimentación pues es peligroso e ilegal. Equipo de Clase I. El producto debe ser conectado a un enchufe con toma de tierra. Sólo use este equipo con el cable de red de alimentación adecuado para su país.

El signo del rayo con la punta de flecha, alerta contra la presencia de voltajes peligrosos no aislados. Para reducir el riesgo de choque eléctrico, no retire la cubierta.



Do not remove mains connector ground, it is dangerous and illegal. Class I device. The product must be connected to mains socket outlet with protective earth connection. Only use this equipment with an appropriate mains cord for your country.

The lightning and arrowhead symbol warns about the presence of uninsulated dangerous voltage. To reduce the risk of electric shock, do not remove the cover.

No instale el aparato cerca de ninguna fuente de calor como radiadores, estufas u otros aparatos que produzcan calor. Debe instalarse siempre sin bloquear la libre circulación de aire por las aletas del radiador.

Do not install near any heat sources such as radiators, heat registers, stoves or other apparatus that produce heat. The circulation of air through the heatsink must not be blocked.

No exponga este equipo a la lluvia o humedad. No use este aparato cerca del agua (piscinas y fuentes, por ejemplo). No exponga el equipo a salpicaduras ni coloque sobre él objetos que contengan líquidos, tales como vasos y botellas. Equipo IP-20.

Do not expose this device to rain or moisture. Do not use this apparatus near water (for example, swimming pools and fountains). Do not place any objects containing liquids, such as bottles or glasses, on the top of the unit. Do not splash liquids on the unit. IP-20 equipment.

Este símbolo indica que el presente producto no puede ser tratado como residuo doméstico normal, sino que debe entregarse en el correspondiente punto de recogida de equipos eléctricos y electrónicos.



Equipo diseñado para funcionar entre 15°C y 45°C con una humedad relativa máxima del 95%, con un rango de  $\pm 10\%$  de la tensión nominal de alimentación indicada en la etiqueta trasera (según IEC 60065). Si debe sustituir el fusible preste atención al tipo y rango.

This symbol on the product indicates that this product should not be treated as household waste. Instead it shall be handed over to the applicable collection point for the recycling of electrical and electronic equipment.

Working temperature ranges from 15°C to 45°C with a relative humidity of 95%, with  $\pm 10\%$  of the rated main voltage value indicated on the rear label (according to IEC 60065). If the fuse needs to be replaced, please pay attention to correct type and ratings.

El cableado exterior conectado al equipo requiere de su instalación por una persona instruida o el uso de cables flexibles ya preparados.

The outer wiring connected to the device requires installation by an instructed person or the use of a flexible cable already prepared.

Si el aparato es conectado permanentemente, la instalación eléctrica del edificio debe incorporar un interruptor multipolar con separación de contacto de al menos 3mm en cada polo.

If the apparatus is connected permanently, the electrical system of the building must incorporate a multipolar switch with a separation of contact of at least 3mm in each pole.

Para desconectar el dispositivo debe usar el enchufe. Desconecte este aparato durante tormentas eléctricas, terremotos o cuando no se vaya a emplear durante largos periodos.

To disconnect the device, you should use the mains plug. Unplug this apparatus during lightning storms, earthquakes or when unused for long periods of time.

No emplace altavoces en proximidad a equipos sensibles a campos magnéticos, tales como monitores de televisión o material magnético de almacenamiento de datos.



Do not place loudspeakers in proximity to devices sensitive to magnetic fields such as television monitors or data storage magnetic material.

Para las cajas con vaso para trípode, la altura máxima de seguridad desde el suelo a la base de la caja montada sobre trípode modelo TRD-2, con pies a 55 cm del eje del trípode, es:

For enclosures with tripod socket, the maximum safety height from floor to bottom of enclosure when mounting on a TRD-2 tripod, with legs spread 55cm from the central pole, is:

altea 412A/712A ----->115 cm  
altea 415A/715A ----->105 cm

altea 412A/712A ----->115 cm  
altea 415A/715A ----->105 cm

El colgado del equipo sólo debe realizarse utilizando los herrajes de colgado recomendados y por personal cualificado. No cuelgue la caja de las asas.

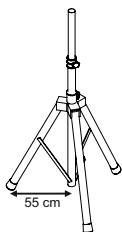

The appliance should be flown only from the rigging points and by qualified personnel. Do not suspend the box from the handles.

No existen partes ajustables por el usuario en el interior de este equipo. Cualquier operación de mantenimiento o reparación debe ser realizada por personal cualificado. Es necesario el servicio técnico cuando el equipo se haya dañado de alguna forma, como que haya caído líquido o algún objeto en el interior del aparato, haya sido expuesto a lluvia o humedad, no funcione correctamente, haya recibido un golpe o su cable de red esté dañado.

No user serviceable parts inside. Refer all servicing to qualified service personnel. Servicing is required when the apparatus has been damaged in any way, such as power-supply cord or plug is damaged, liquid has been spilled or objects have fallen into the apparatus, the apparatus has been exposed to rain or moisture, does not operate normally or has been dropped.

Limpie con un paño seco. No use limpiadores con disolventes.

Clean only with a dry cloth. Do not use any solvent based cleaners.

## **GARANTÍA**

Todos nuestros productos están garantizados por un periodo de 24 meses desde la fecha de compra.

Las garantías sólo serán válidas si son por un defecto de fabricación y en ningún caso por un uso incorrecto del producto.

Las reparaciones en garantía pueden ser realizadas, exclusivamente, por el fabricante o el servicio de asistencia técnica autorizado.

Otros cargos como portes y seguros, son a cargo del comprador en todos los casos.

Para solicitar reparación en garantía es imprescindible que el producto no haya sido previamente manipulado e incluir una fotocopiada de la factura de compra.

## **WARRANTY**

All D.A.S. products are warrantied against any manufacturing defect for a period of 2 years from date of purchase.

The warranty excludes damage from incorrect use of the product.

All warranty repairs must be exclusively undertaken by the factory or any of its authorised service centers.

To claim a warranty repair, do not open or intend to repair the product.

Return the damaged unit, at shippers risk and freight prepaid, to the nearest service center with a copy of the purchase invoice.





## DECLARACIÓN DE CONFORMIDAD DECLARATION OF CONFORMITY

### **D.A.S. Audio, S.A.**

C/ Islas Baleares, 24 - 46988 - Pol. Fuente del Jarro - Valencia. España (Spain).

Nota: Los textos completos de la declaración de conformidad para *altea 712A* y *altea 715A* están disponibles en <http://d.dasaudio.com/fl9Df>.

Note: The full text of the declaration of conformity for *altea 712A* and *altea 715A* is available at <http://d.dasaudio.com/fl9Df>.

Declara que los otros productos de la *serie activa de altea*:  
Declares that the other models of *active altea series*:

Cumple con los objetivos esenciales de las Directivas:  
Abide by essential objectives relating Directives:

- Directiva de Baja Tensión (Low Voltage Directive) 2014/35/UE
- Directiva de Compatibilidad Electromagnética (EMC) 2014/30/UE
- Directiva RoHS 2011/65/UE
- Directiva RAEE (WEEE) 2012/19/UE

Y es conforme a las siguientes Normas Armonizadas Europeas:  
In accordance with Harmonized European Norms:

- EN 60065:2014.- Audio, video and similar electronic apparatus. Safety requirements.
- EN 55032:2012.- Electromagnetic compatibility of multimedia equipment. Emission requirements.
- EN 55103-2:2009.- Electromagnetic compatibility. Product family standard for audio, video, audio-visual and entertainment lighting control apparatus for professional use. Part 2:Immunity.
- EN 50581:2012.- Technical documentation for the assessment of electrical and electronic products with respect to the restriction of hazardous substances.

## INTRODUCTION

The altea series inherits the exceptional sound quality and rugged build that have made D.A.S. professional systems an international sound reinforcement standard. Designed from “real-world” experience, they offer users outstanding performance, absolute reliability, and unparalleled convenience. Whether it is in a high-profile venue or on the stage of a major event, the altea series will provide the power and definition needed to make your performance a success.

### Features

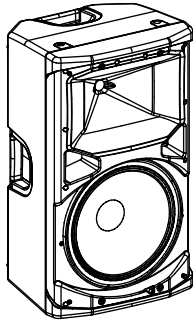

#### *altea 412A / 712A*

- Two-way self-powered speaker
- 12" bass loudspeaker .
- Compression driver with high tech polymer diaphragm.
- Symmetrical enclosure design for stage monitor use.
- 4 handles.
- Built-in rigging points (eyebolt based).
- Stand mountable; 35mm tripod socket.

The altea 412A is a powered loudspeaker (2 channel Class D, 400W<sub>continuous</sub> amplifier), that utilizes a 12" low frequency transducer and a 1" exit compression driver. The multi-angle cabinet is constructed of polypropylene.

The altea 712A is a powered loudspeaker (2 channel Class D, 700W<sub>continuous</sub> amplifier), that utilizes a 12" low frequency transducer and a 1" exit compression driver. The multi-angle cabinet is constructed of polypropylene. The system can be controlled wireless by using the DASlink APP.

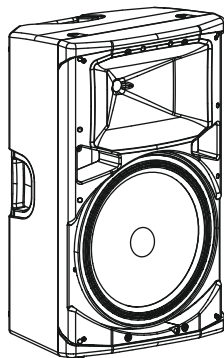

#### *altea 415A / 715A*

- Two-way self-powered speaker
- 15" bass loudspeaker .
- Compression driver with high tech polymer diaphragm.
- Symmetrical enclosure design for stage monitor use.
- 4 handles.
- Built-in rigging points (eyebolt based).
- Stand mountable; 35mm tripod socket.

The altea 415A is a powered loudspeaker (2 channel Class D, 400W<sub>continuous</sub> amplifier), that utilizes a 15" low frequency transducer and a 1" exit compression driver. The multi-angle cabinet is constructed of polypropylene.

The altea 715A is a powered loudspeaker (2 channel Class D, 700W<sub>continuous</sub> amplifier), that utilizes a 15" low frequency transducer and a 1" exit compression driver. The multi-angle cabinet is constructed of polypropylene. The system can be controlled wireless by using the DASlink APP.

**CONFIGURATIONS**

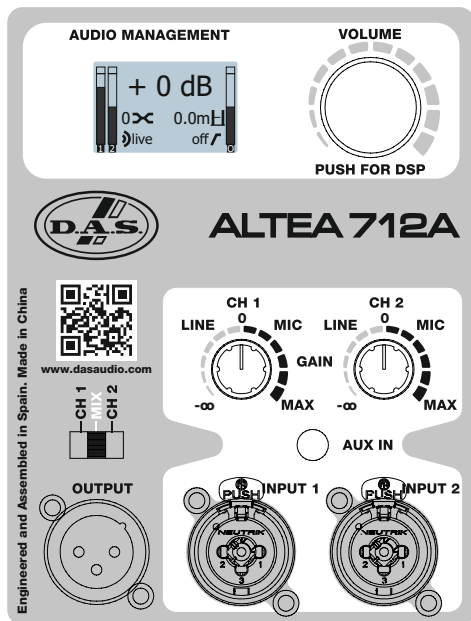
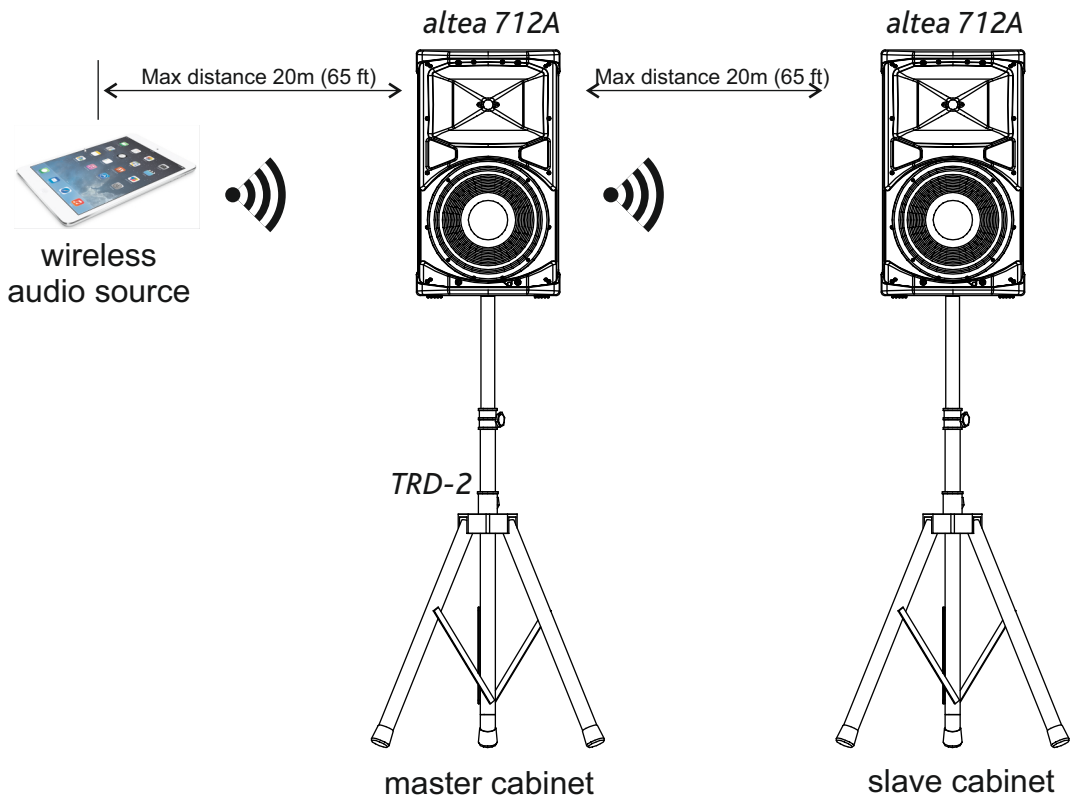

Consult chapter Wireless Audio Connectivity in this manual for setting up the link between the audio source and the cabinets.

Use DASlink APP to control and monitor your system!

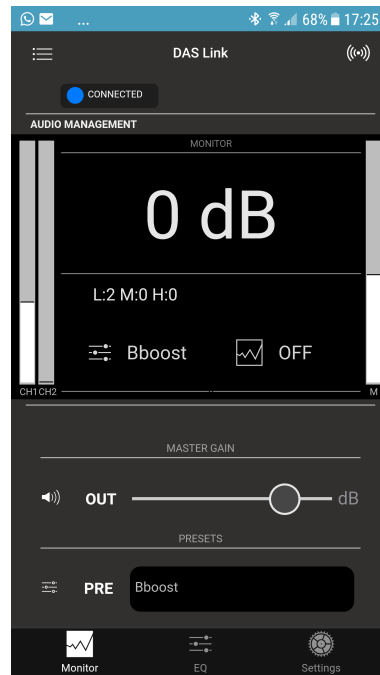

**CONFIGURATIONS (cont'd)**

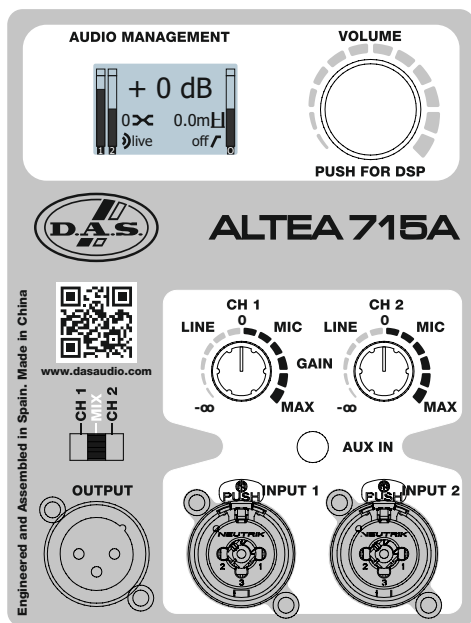
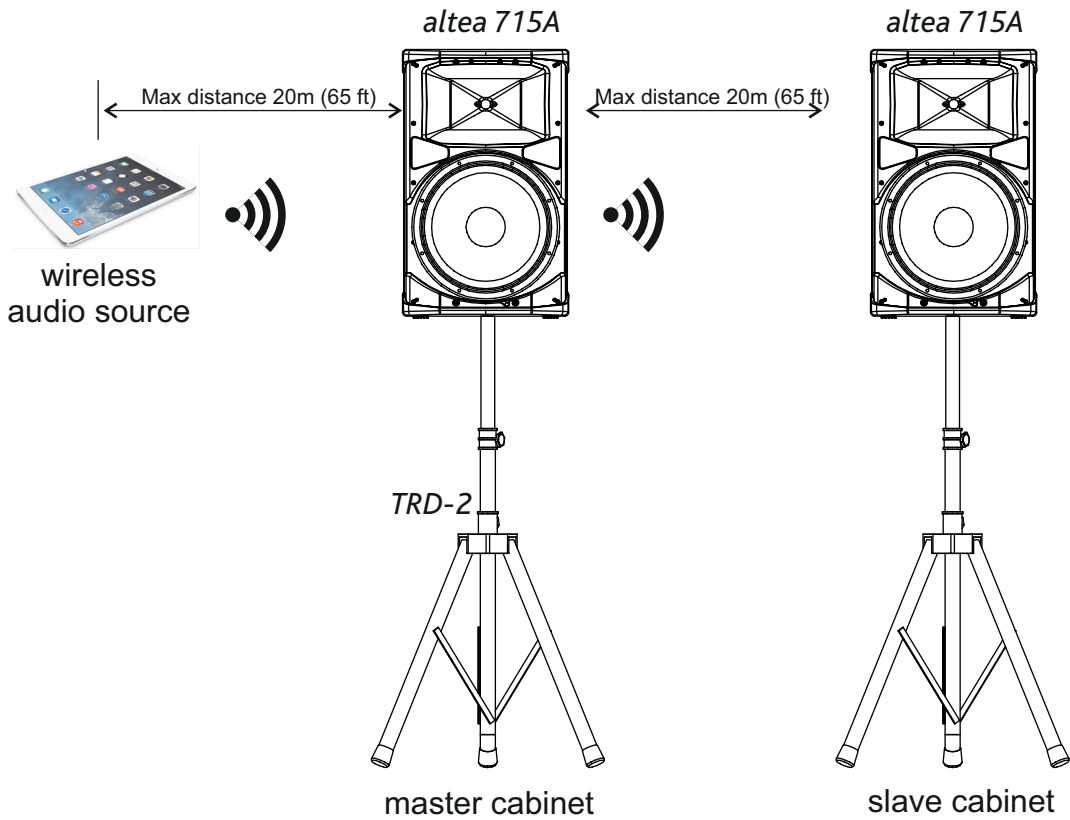

Consult chapter Wireless Audio Connectivity in this manual for setting up the link between the audio source and the cabinets.

Use DASlink APP to control and monitor your system!

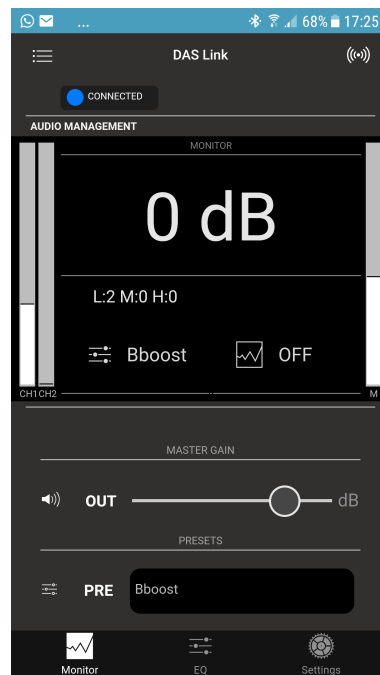

**CONFIGURATIONS (cont'd)**

altea 412A / 712A

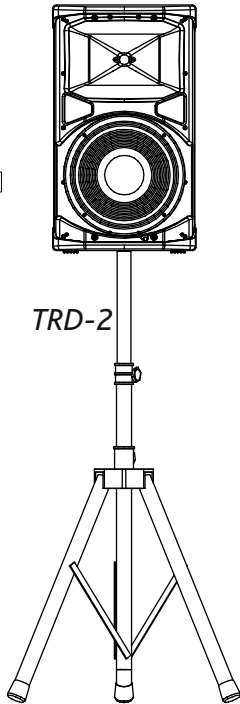

altea 412A / 712A

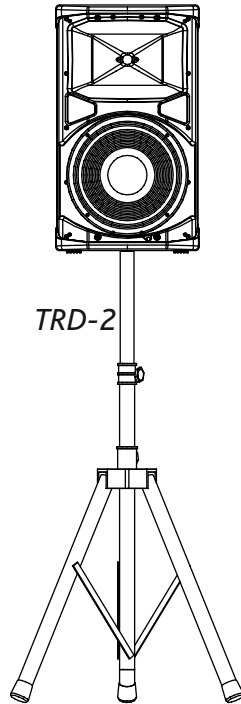

Mixer

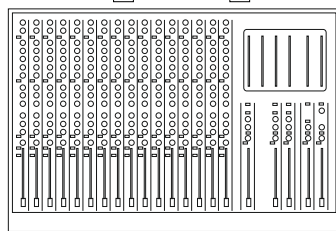

**AUDIO MANAGEMENT** **VOLUME**

+ 0 dB  
0x 0.0mH  
live off

PUSH FOR DSP

CH 1 CH 2  
LINE 0 MIC LINE 0 MIC  
-∞ MAX -∞ MAX  
GAIN

AUX IN

OUTPUT INPUT 1 INPUT 2

**D.A.S.** **ALTEA 412A**

Engineered and Assembled in Spain... Made in China  
www.dasaudio.com

**AUDIO MANAGEMENT** **VOLUME**

+ 0 dB  
0x 0.0mH  
live off

PUSH FOR DSP

**D.A.S.** **ALTEA 712A**

CH 1 CH 2  
LINE 0 MIC LINE 0 MIC  
-∞ MAX -∞ MAX  
GAIN

AUX IN

OUTPUT INPUT 1 INPUT 2

Engineered and Assembled in Spain... Made in China  
www.dasaudio.com

**CONFIGURATIONS (cont'd)**

*altea 415A / 715A*

*altea 415A / 715A*

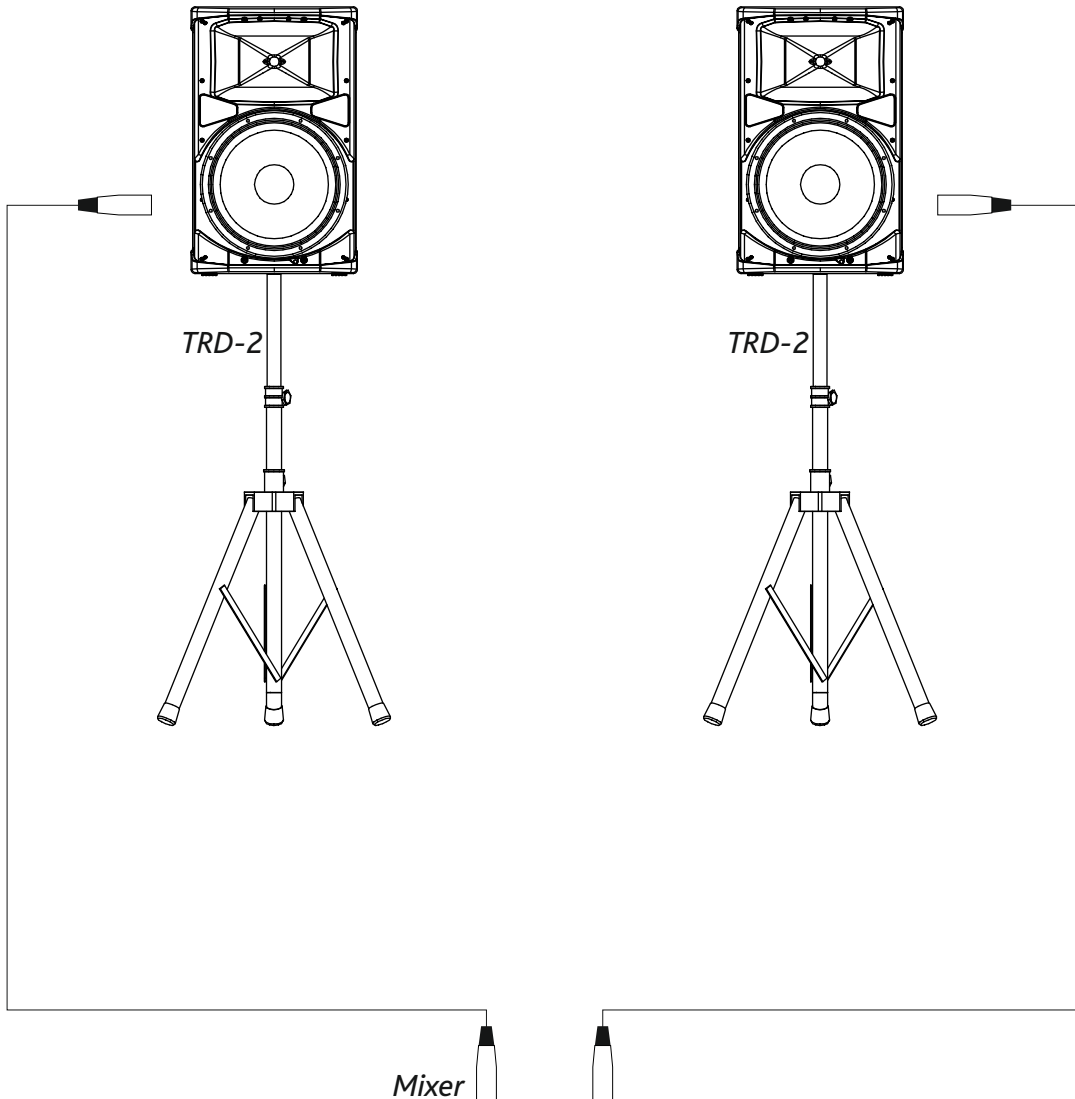

**AUDIO MANAGEMENT** **VOLUME**

+ 0 dB  
0x 0.0mH  
live off

PUSH FOR DSP

CH 1 CH 2  
LINE 0 MIC LINE 0 MIC  
-∞ MAX -∞ MAX  
GAIN

AUX IN

OUTPUT INPUT 1 INPUT 2

**D.A.S.** **ALTEA 415A**

Engineered and Assembled in Spain... Made in China  
www.dasaudio.com

**Mixer**

**AUDIO MANAGEMENT** **VOLUME**

+ 0 dB  
0x 0.0mH  
live off

PUSH FOR DSP

**D.A.S.** **ALTEA 715A**

CH 1 CH 2  
LINE 0 MIC LINE 0 MIC  
-∞ MAX -∞ MAX  
GAIN

AUX IN

OUTPUT INPUT 1 INPUT 2

Engineered and Assembled in Spain... Made in China  
www.dasaudio.com

**CONFIGURATIONS (cont'd)**

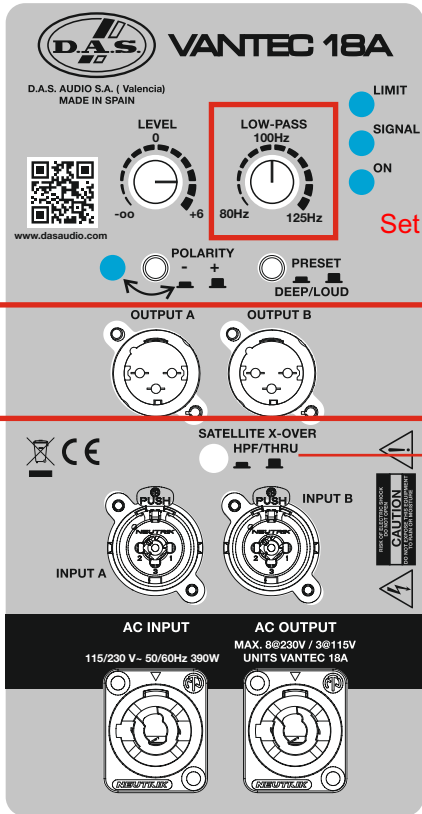

Set Low Pass Filter at 100Hz

Use Left and Right Satellite Outputs

Do not press HPF satellite X-over

atea 412A / 712A

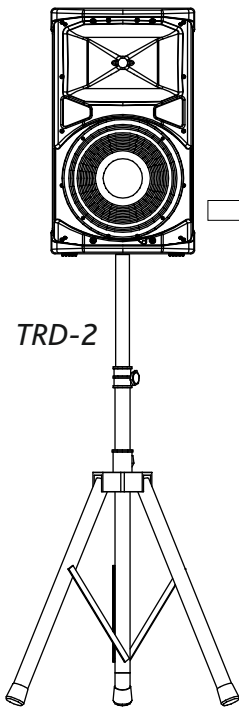

atea 412A / 712A

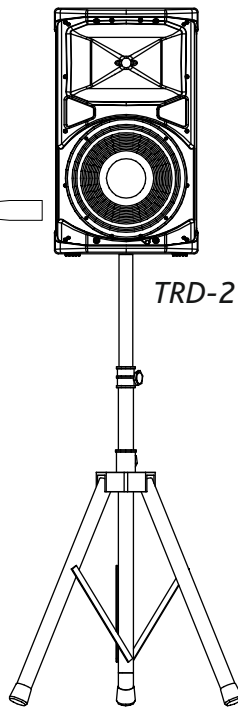

Vantec 18A

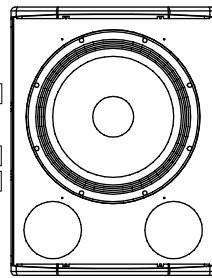

Mixer

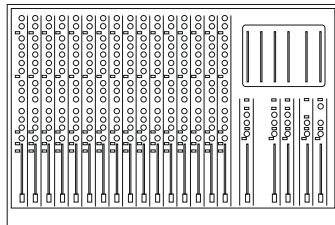

Select HPF (High Pass Filter) At18A in the altea amplifiers

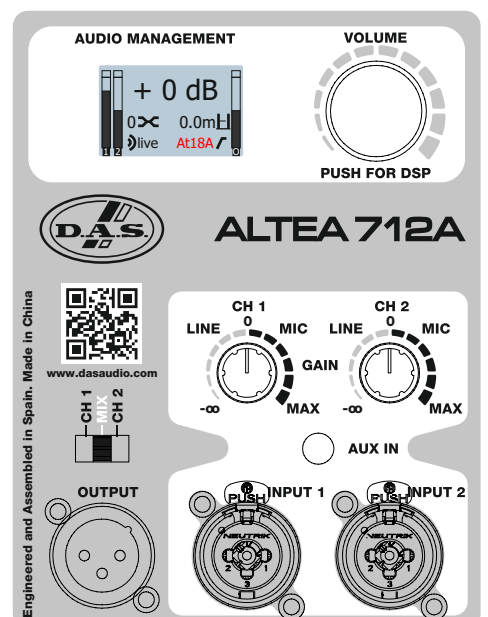
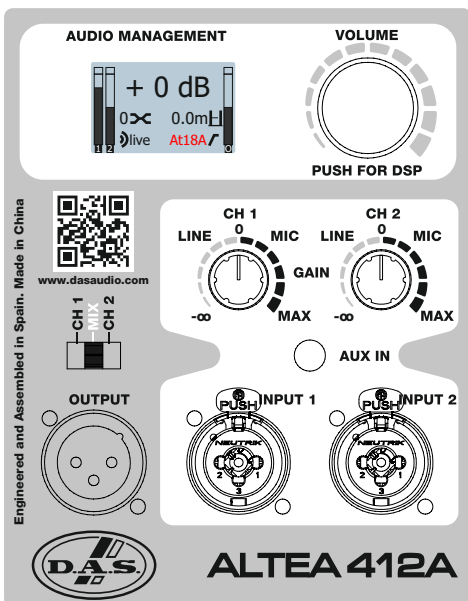



**CONFIGURATIONS (cont'd)**

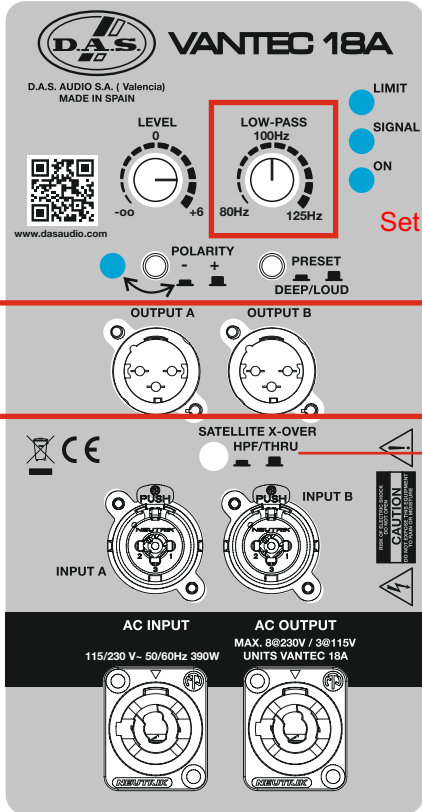

Set Low Pass Filter at 100Hz

Use Left and Right Satellite Outputs

Do not press HPF

altea 415A / 715A

altea 415A / 715A

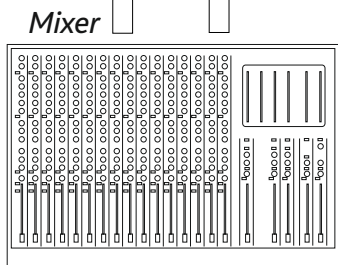
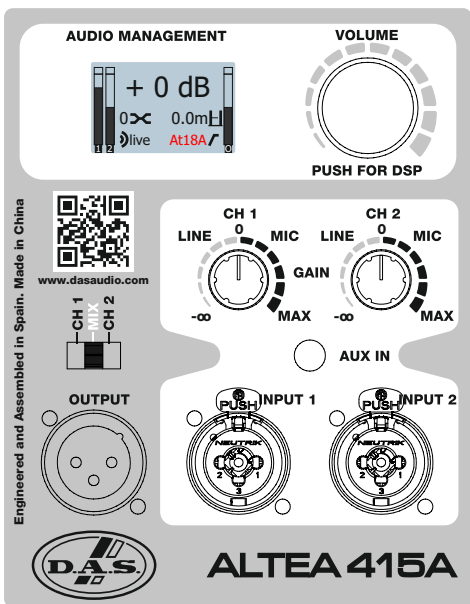
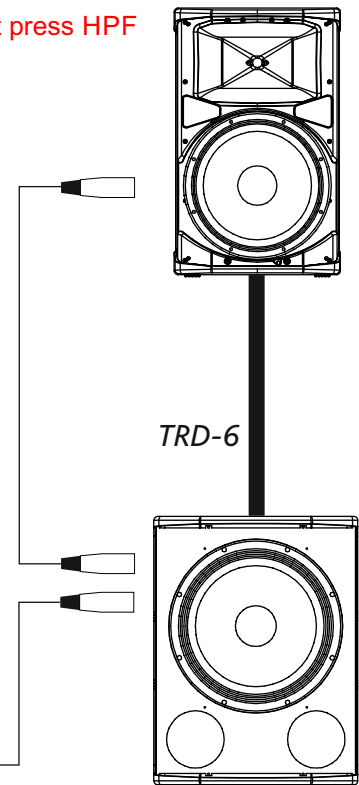
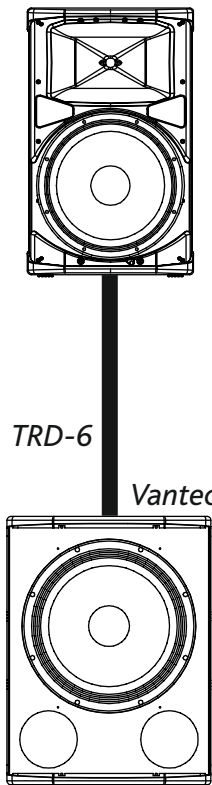

Select HPF (High Pass Filter) At18A in the altea amplifiers

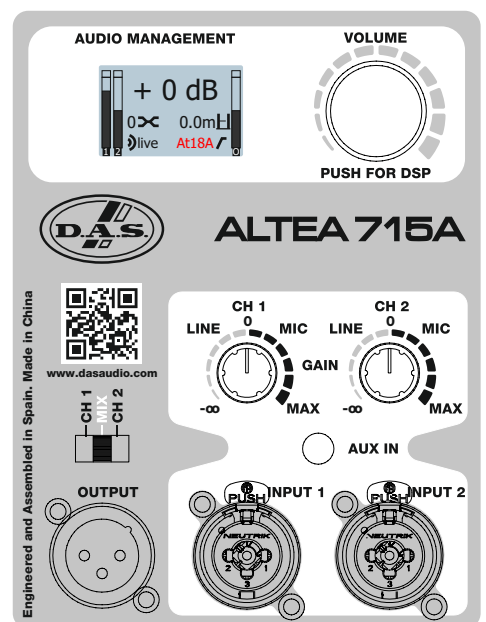



LINE DRAWINGS

altea 412A / 712A

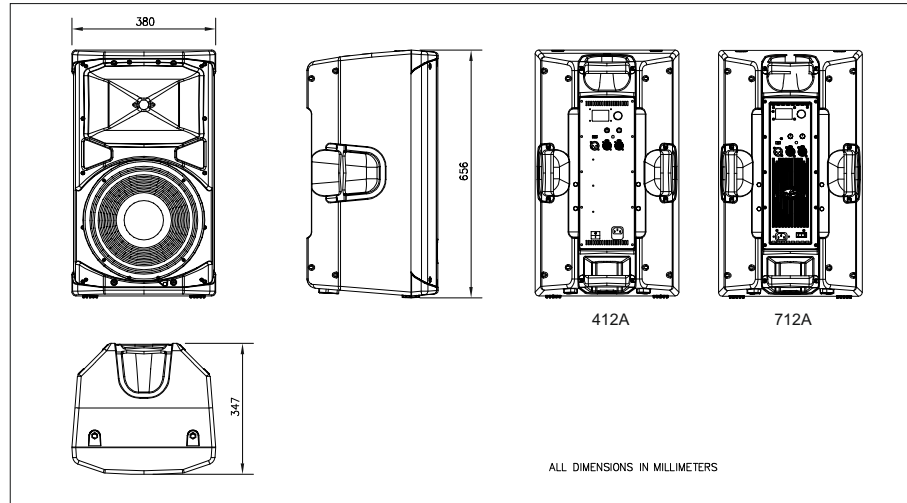

altea 415A / 715A

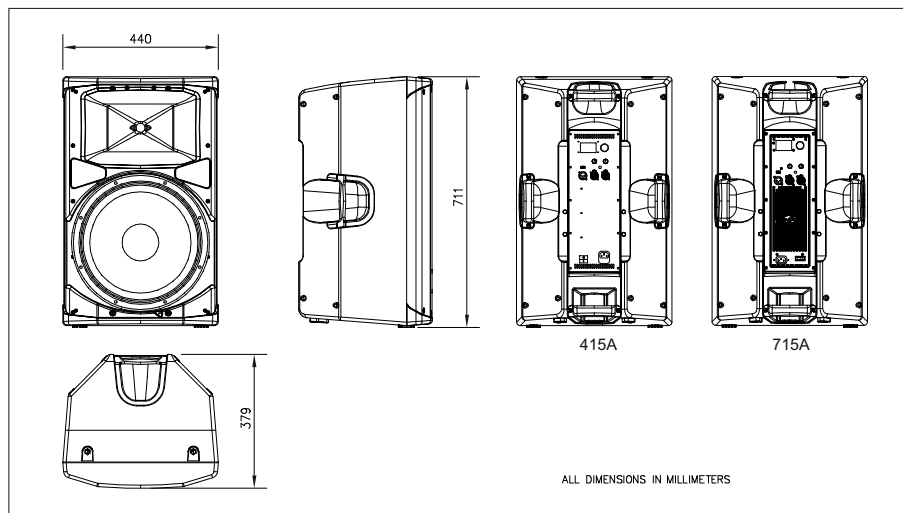

## SPECIFICATIONS

Model	altea 412A	altea 415A	altea 712A	altea 715A
Power Amplifier	800 W <sub>peak</sub> Class D Bi-amplified	800 W <sub>peak</sub> (Class D Bi-amplified)	1500 W <sub>peak</sub> (Class D Bi-amplified)	1500 W <sub>peak</sub> (Class D mono amplified)
Input Type	Balanced Differential Line	Balanced Differential Line	Balanced Differential Line	Balanced Differential Line
Input Impedance	Line: 20 kohms	Line: 20 kohms	Line: 20 kohms	Line: 20 kohms
Sensitivity	Line: 1.95V (+8dBu)	Line: 1.95V (+8dBu)	Line: 1.95V (+8dBu)	Line: 1.95V (+8dBu)
Frequency Range (-10 dB)	60 Hz - 20 kHz	50 Hz - 20 kHz	60 Hz - 20 kHz	45 Hz - 20 kHz
HF Horn Coverage Angles (-6 dB)	90° x 60°	90° x 60°	90° x 60°	90° x 60°
Maximum Peak SPL at 1m	126 dB	128 dB	130 dB	132 dB
Transducers/ Replacement Parts	LF: 12Mi4 / GM-12Mi4 HF: M-32 / M-32	LF: 15Mi4 / GM-15Mi4 HF: M-32 / M-32	LF: 12F4 / GM-12F4 HF: M-28 / M-28	LF: 15FV4 / GM-15FV4 HF: M-28 / M-28
Enclosure Material	Textured polypropylene	Textured polypropylene	Textured polypropylene	Textured polypropylene
Color/Finish	Black	Black	Black	Black
Connectors	INPUT: Female XLR LOOP THRU: Male XLR AC INPUT: MALE IEC	INPUT: Female XLR LOOP THRU: Male XLR AC INPUT: MALE IEC	INPUT: Female XLR LOOP THRU: Male XLR AC INPUT: MALE IEC	INPUT: Female XLR LOOP THRU: Male XLR AC INPUT: MALE IEC
AC Power Requirerments	115V, 2.4A, 50 Hz / 60 Hz 230V, 1.2A, 50 Hz / 60 Hz	115V, 2.4A, 50 Hz / 60 Hz 230V, 1.2A, 50 Hz / 60 Hz	115V, 3A, 50 Hz / 60 Hz 230V, 1.5A, 50 Hz / 60 Hz	115V, 3A, 50 Hz / 60 Hz 230V, 1.5A, 50 Hz / 60 Hz
Dimensions (H x W x D)	65 x 38 x 34.6 cm 25.6 x 15 x 13.6 in	71 x 44 x 38 cm 28 x 17.3 x 15 in	65 x 38 x 34.6 cm 25.6 x 15 x 13.6 in	71 x 44 x 38 cm 28 x 17.3 x 15 in
Weight	17.9 kg (38.7 lb)	19.3 kg (42.5 lb)	18.9 kg (41.6 lb)	20.6 kg (45.3 lb)
Accessories	ANL-1 Eye Bolt TRD-2 Speaker Stand TRD-6 Pole Mount FUN-altea12	ANL-1 Eye Bolt TRD-2 Speaker Stand TRD-6 Pole Mount FUN-altea15	ANL-1 Eye Bolt TRD-2 Speaker Stand TRD-6 Pole Mount FUN-altea12	ANL-1 Eye Bolt TRD-2 Speaker Stand TRD-6 Pole Mount FUN-altea15

**D.A.S. Audio S.A.** continuously strives to enhance its products through investigation and development. All specifications are subject to change without prior warning.

## AMPLIFIER

### Description: altea 400 / altea 700 active series

#### 1) MASTER VOLUME AND DSP CONTROL:

Use the encoder to select the desired output volume and push/hold it to access to the different DSP and cabinet settings.

#### 2) MAIN SCREEN:

In the main screen all selected parameters and settings are shown. Besides this, there are two input level indicators on the left, one output level indicator on the right and the center area is reserved to display messages as Input Clip or Limit.

#### 3) INPUT connectors :

1/4" Jack+XLR combined socket-type input signal connectors. This is a balanced connector just like the LOOP THRU connector with the following pin assignments

- 1 or S =GND (ground).
- 2 or T =(+) Non inverted input.
- 3 or R =(-) Inverted input.

#### 4) OUTPUT

XLR-type output signal connector for connecting several units together and sending them all the same signal. The user can select the signal going out; can be Ch1, Ch2 or MIX (see 6).

#### 5) INPUT GAIN CONTROL:

For channels 1 and 2, gain control, line and microphone.

Note: Wireless Audio Signal is controlled with gain knob 1. Wireless audio only available in 700 series.

#### 6) OUTPUT mix selector:

It allows the user to select which input channel signal to send to other cabinets. User can select Ch1, Ch2 or both (Mix).

#### 7) AUX in:

3.5 mm audio jack input for connecting external audio media devices, such as MP3 players.

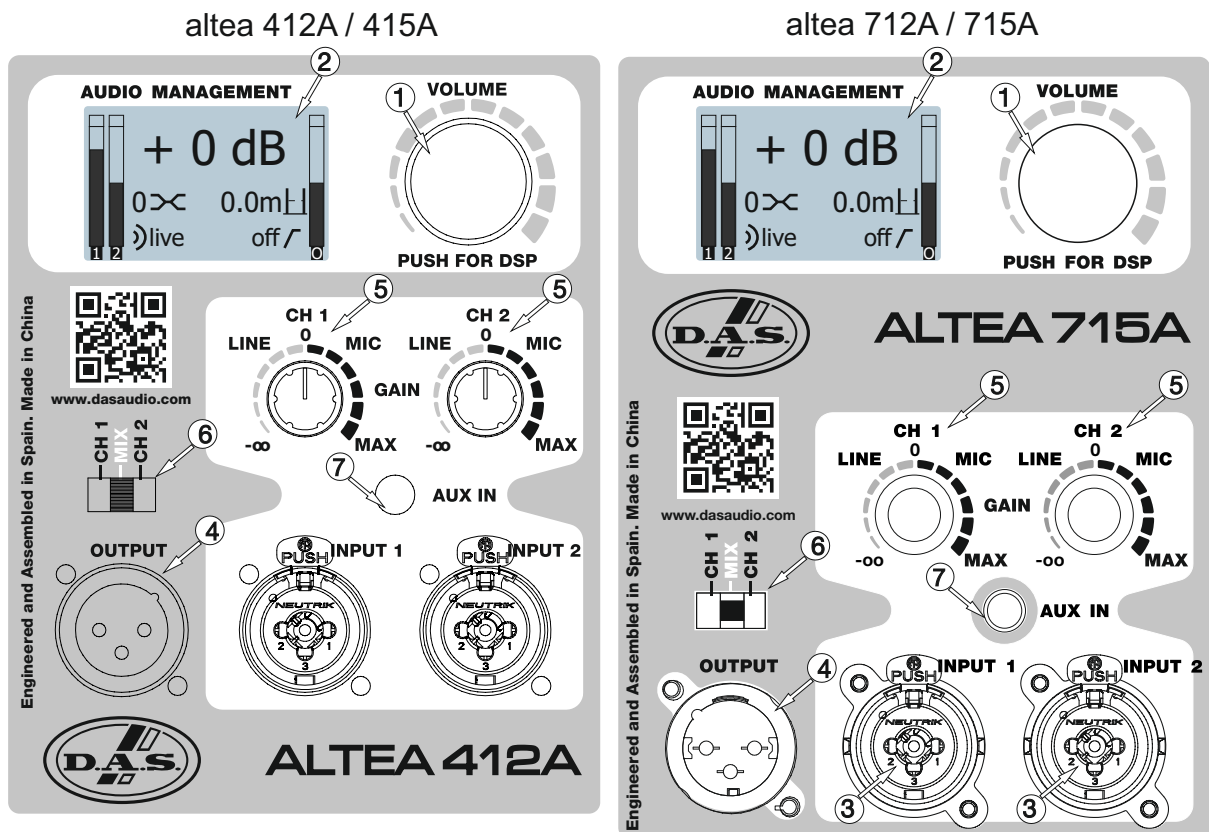

## ON / OFF

A sound system should be switched on sequentially. Switch on the self-powered units last in your sound system (switch on the subwoofer before the mid-high system). Switch on the sound sources such as CD players or turntables, then the mixer, then the processors, and finally the selfpowered unit. If you have several units, it is recommended that you switch them on sequentially one at a time.

Follow the inverse order when switching off, turning self-powered units off before any other element in the sound system.

Disconnect the device by removing the mains connector from the mains socket on the amplifier's rear panel. The mains connector and mains socket must always be freely accessible and never covered or blocked in any way. The mains cable can be detached from the device by disconnecting the standard IEC connector.

**IMPORTANT:** Do not disconnect the unit while in use. Ensure that the device is disconnected from the mains by observing that the DISPLAY is turned off.

## Overload Display indicators (limit and Input Clip)

In the main screen when input signal levels are too high on the left side (input channels) the meters will display "input clip":

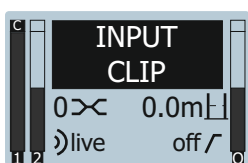

If the input levels are in between the limits but the output level gain is too high, the right meter will display "limit".

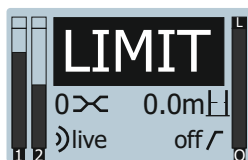

Please keep the gain structure of the system within the limits (no INPUT clip and NO LIMIT shown) in order to keep the system safe and free of distortion. To maintain that gain structure below reaching LIMIT or INPUT clip, besides the level of the source (Master Output of the console etc) the user can adjust levels with the input knob controls (2) and the Master Volume control (1):

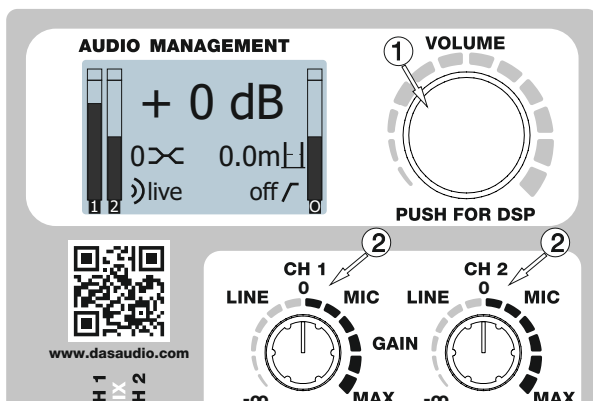

## Equalisation

The unit does not need external settings of equalisation to produce quality sound.

In fact the unit has an internal 3 band equalizer (Low/Mid/High) adjustable by the user. Besides this, keep in mind all the possible presets available in the DSP (live, dance, bboost, etc).

## Overheating

This equipment does not normally overheat during normal conditions of use. It has been designed and tested at DAS Audio Laboratories to work under hard thermal conditons with high output levels (limit conditions). If overheating occurs, the unit protects itself by lowering the output power. You should then find out why and if necessary contact an authorised service center for technical assistance.

Normally it is enough just to let the unit cool down after you have corrected the problem so that the system functions properly again.

## Low mains voltage

If mains voltage falls below the shutdown voltage for the unit, it will stop playing. When acceptable levels are regained, the unit will switch back on automatically. For altea 400 series the shutdown level is around 90V. For altea 700 series the shutdown level is 80V.

Therefore the current consumed by a 115V version is double the 230V version to achieve the same acoustic power level.

<i>Pink Noise Mains 230 Vrms</i>	1/3 Power
<i>altea 412A</i>	1.2A
<i>altea 415A</i>	1.2A
<i>altea 712A</i>	1.5A
<i>altea 715A</i>	1.5A

## DISPLAY

### ADJUSTING THE LEVELS:

By default the state of the screen is the following:

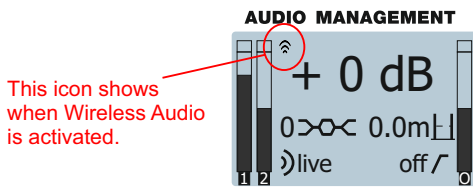

Once the input source (s) have been connected to the amplifier's cabinet, the user has to adjust the levels.

For the two input channels (1 and 2), two independent gain controls are available. Be careful when setting the input volume and do not exceed the maximum level shown at the meters: (input clip)

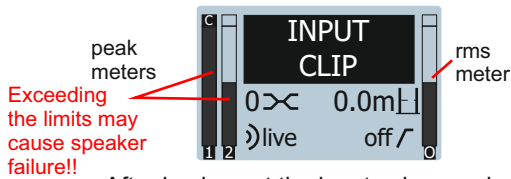

After having set the input volume values under the maximum level, user has to adjust output volume with the master control. The level is shown in the right meter in the screen. As with the inputs be careful not to exceed the limit: (LIMIT shown)

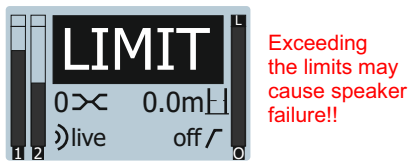

After these two volume adjustments the screen will show something like this (when having the input sources ON):

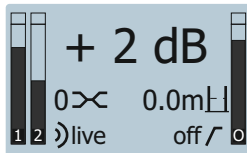

### MAIN MENU:

As stated previously by pushing the encoder the user can access to the following options in the MENU:

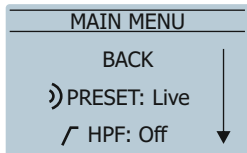

**Note:** to enter and select an option always push the encoder. For going back in the menu, the user has to select *Back* in the screen and press the encoder or just pushing the encoder.

### System presets

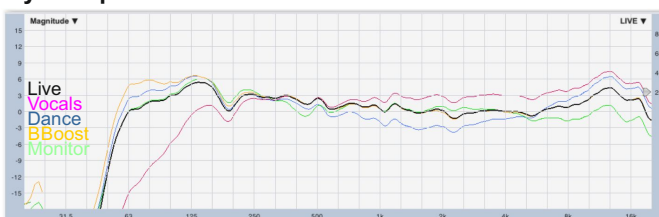

By scrolling down the encoder more options appear:

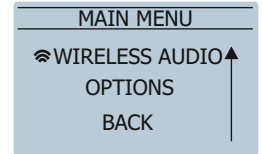
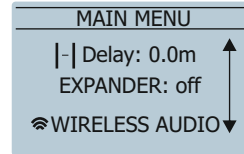
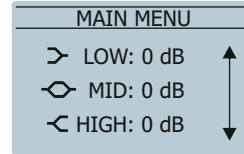

### PRESETS:

Five factory settings (*live, dance, vocals, bboost, monitor*) depending on the type of music/use have been configured by default:



With the encoder go to Preset Sub-menu and press the knob to access to the different options:

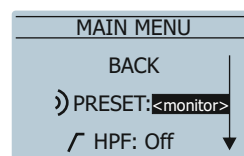
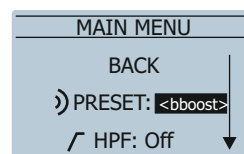
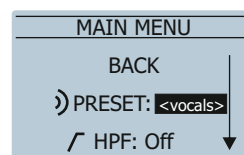
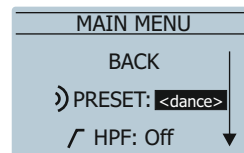
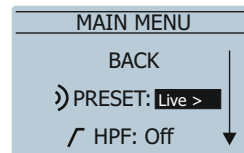
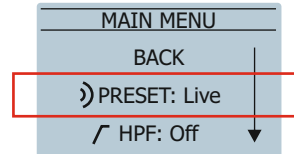

### HPF (High Pass Filter):

Four options are available for the cabinets. Go to the HPF Sub-menu and press the encoder. Options appear:

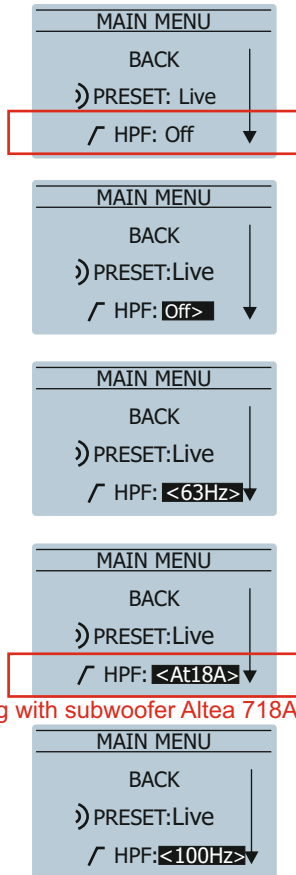

when combining with subwoofer Altea 718A or Vantec 18A

### LOW / MID:

Boosting the energy in the low / mid range is possible by the use of this parameter, Besides the user can remove energy. The scale goes from -10dB to +6dB. As with the previous options use the encoder to move in the main menu till the LOW/MID sub menu. Then press again and you will enter the dB selector:

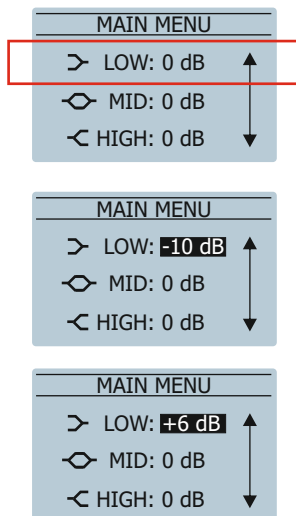

### HIGH:

Boosting the energy in the high end is possible by the use of this parameter, Besides the user can remove energy. The scale goes from -10dB to +6dB. As with the previous options use the encoder to move in the main menu till the HIGH sub menu. Then press again and you will enter the dB selector:

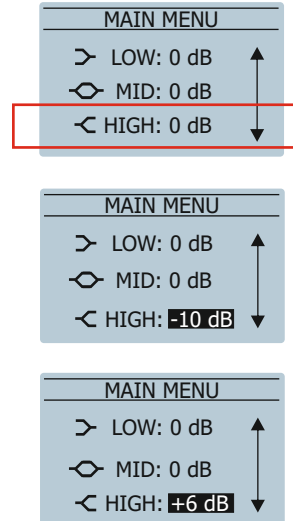

### DELAY:

The user can set up a delay in the cabinets by using the delay Sub-menu; from 0 to 9.9m :

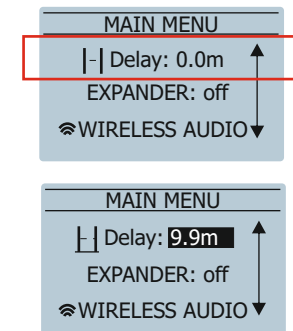

### EXPANDER:

By default it is not activated. It works very similar to a noise gate with a smoother response.

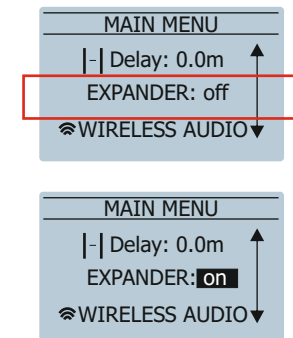

**OPTIONS:**

In this sub-menu the user can configure all these options. Remember that in order to access each parameter it is necessary to push the encoder:

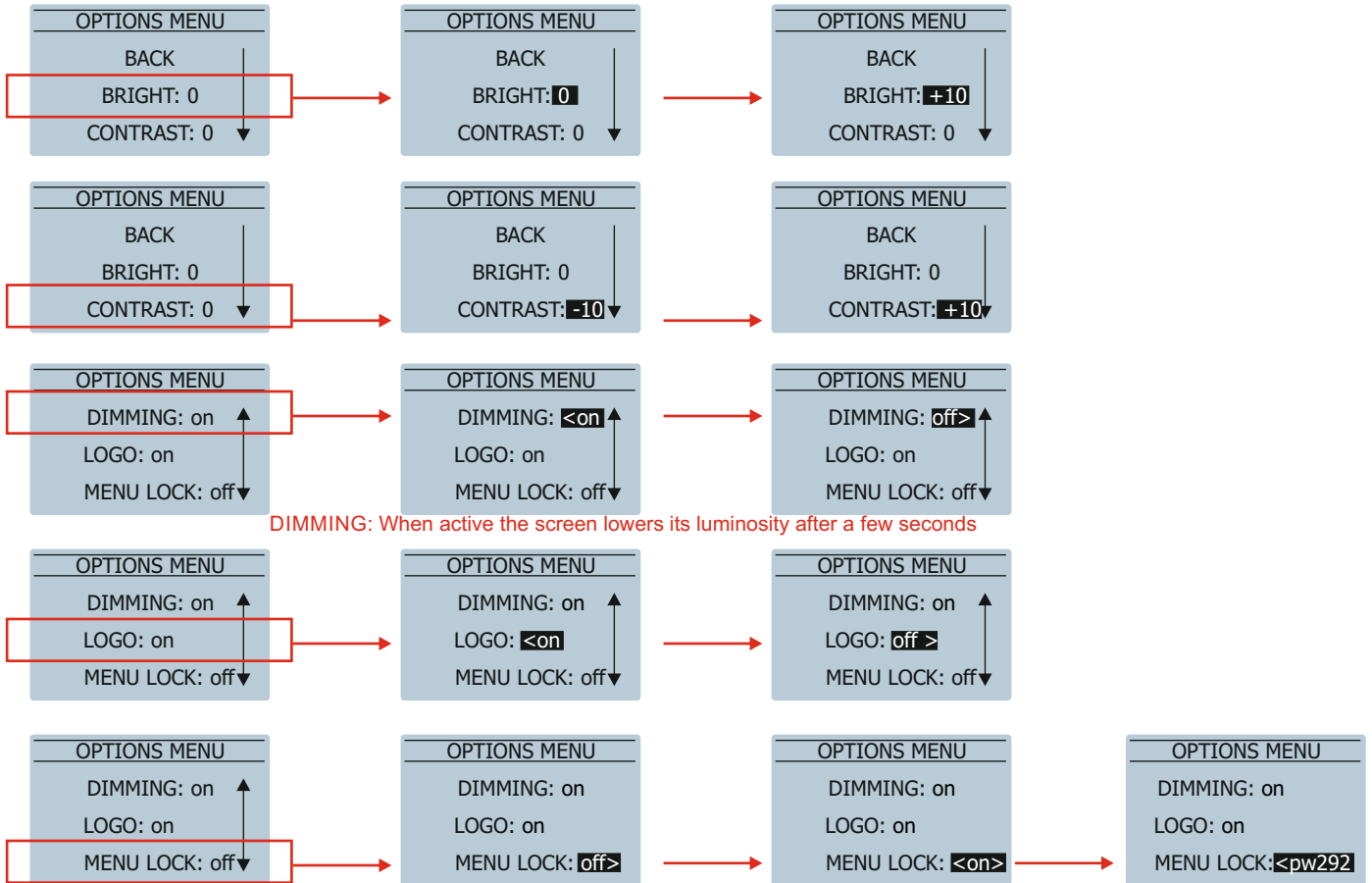

DIMMING: When active the screen lowers its luminosity after a few seconds

A. User can LOCK the Display and Master Volume Control by enabling this option MENU LOCK: ON

B. User can LOCK the Display and Master Volume Control WITH PASSWORD by enabling this option MENU LOCK: pw292

In case A to unlock just press the encoder:

In case B to unlock PUSH encoder and enter the 3 digit password (292):

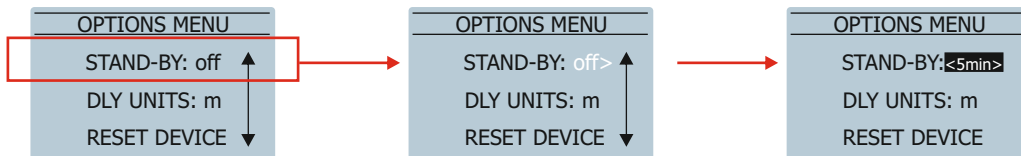
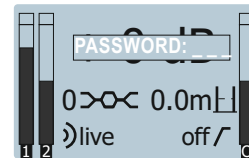
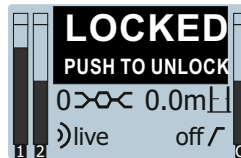

STAND-BY: When no signal is detected the amplifier shuts down. Time can be selected

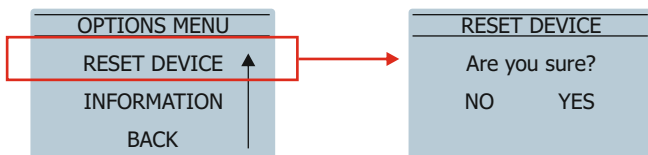
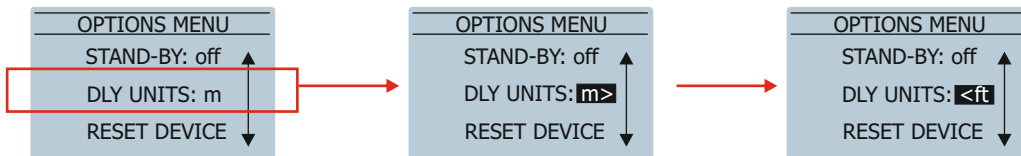

This option resets the device to the following values: Preset: live  
 (All Wireless Audio and control pairing will be lost) HPF: off  
 Delay: 0m  
 Low / Mid / High: 0dB  
 Stand-By: off  
 Dimming: On





## TROUBLESHOOTING

PROBLEM	CAUSE	SOLUTION
No sound from the unit. The input meters in the screen do not show any signal presence.	<ol style="list-style-type: none"> <li>1 - The signal source is sending no signal.</li> <li>2 - Input gain controls are at minimum position.</li> <li>3 - Defective cable.</li> <li>4 - If Wireless Audio is connected input 1 which controls audio is at minimum position or Volume of the source is muted.</li> </ol>	<ol style="list-style-type: none"> <li>1 - Check that the source is not muted and is sending signal to the unit.</li> <li>2 - Check input gain controls. Put them at 0dB.</li> <li>3 - Check that the cable from the source to the unit is connected correctly. Replace the cable if defective.</li> <li>4 - Adjust Volume of input gain control number one.</li> </ol>
Full power cannot be obtained. LIMIT message never appears in the screen.	<ol style="list-style-type: none"> <li>1 - The signal source does not have enough output level.</li> <li>2 - Input gain controls are at very low volume.</li> <li>3 - Master Volume is very low.</li> </ol>	<ol style="list-style-type: none"> <li>1 - Use balanced outputs of a mixer. Rise master output volume of the source.</li> <li>2 - Set up input gain controls at higher positions.</li> <li>3 - Increase Volume by turning up the Master Volume control.</li> </ol>
Sound is distorted. INPUT CLIP message is shown.	<ol style="list-style-type: none"> <li>1-The mixer or signal source is distorting.</li> <li>2 - The output level from the mixer is too high.</li> <li>3 - Input gain controls are set too high.</li> </ol>	<ol style="list-style-type: none"> <li>1-Turn down the mixer's output and check no channels are distorting.</li> <li>2-Turn down the mixer's output.</li> <li>3 - Turn down input gain controls.</li> </ol>
Sound is distorted. LIMIT message is displayed.	The system is overloaded and has reached maximum power.	<ol style="list-style-type: none"> <li>1 - Turn down the mixer's output.</li> <li>2 - Turn down the master output volume in the unit.</li> </ol>
Hum or buzz when a mixer is connected to the unit.	<ol style="list-style-type: none"> <li>1-The console probably has unbalanced outputs. You may be using an incorrect unbalanced to balanced cable.</li> <li>2 - The mixer and the powered speaker are not plugged into the same mains outlet.</li> <li>3 - The audio signal cable is too long or too close to an AC cable.</li> </ol>	<ol style="list-style-type: none"> <li>1-Read the appendix of this manual to make a correct unbalanced to balanced cable.</li> <li>2 - Connect the mixer and the unit to the same mains outlet.</li> <li>3 - Use a cable that is as short as possible and/or move the audio signal cable away from mains cables.</li> </ol>
Hum or buzz when using lighting controls in the same building.	<ol style="list-style-type: none"> <li>1-The audio signal cable is too long or too close to the lighting cable.</li> <li>2 - On a sound system with three phase AC, the lighting equipment and the unit are connected to the same phase.</li> </ol>	<ol style="list-style-type: none"> <li>1- Move the audio signal cable away from lighting cables. Try to find out at what point the noise is leaking into the system.</li> <li>2 - Connect the sound system to a different phase than the lights. You may need the help of an electrician.</li> </ol>
The screen does not light up when the mains connector is connected and the power switch ON.	<ol style="list-style-type: none"> <li>1 - Bad or loose AC connection to the unit or the mains outlet.</li> <li>2 - Faulty AC cable.</li> <li>3 - Blown Fuse.</li> <li>4 - The mains voltage is out of range.</li> <li>5 - Damaged amplifier.</li> </ol>	<ol style="list-style-type: none"> <li>1 - Check your connections.</li> <li>2 - Check the cables, connectors and AC power with a suitable mains tester.</li> <li>3 - Replace the blown fuse with another of the same type and size.</li> <li>4 - If the multimeter determines that the mains voltage is out of the range you may need the assistance of an electrician to find an appropriate solution.</li> <li>5 - Contact a qualified tech service center.</li> </ol>

### Warnings

This manual contains needed information for flying D.A.S. Audio cabinets, description of the elements and safety precautions. To perform any operations related to flying the system, read the present document first, and act on the warnings and advice given. The goal is to allow the user to become familiar with the mechanical elements required to fly the acoustic system, as well as the safety measures to be taken during set-up and teardown.

Only experienced installers with adequate knowledge of the equipment and local safety regulations should fly speaker boxes. It is the user's responsibility to ensure that the systems to be flown (including flying accessories) comply with state and local regulations.

The working load limits in this manual are the results of tests by independent laboratories. It is the user's responsibility to stay within safe limits. It is the user's responsibility to follow and comply with safety factors, resistance values, periodical supervisions and warnings given in this manual. Product improvement by means of research and development is on going at D.A.S. Specifications are subject to change without notice.

To this date, there is no international standard regarding the flying of acoustic systems. However, it is common practice to apply 5:1 safety factors for enclosures and static elements. For slings and elements exposed to material fatigue due to friction and load variation the following ratios must be met; 5:1 for steel cable slings, 4:1 for steel chain slings and 7:1 polyester slings. Thus, an element with a breaking load limit of 1000 kg may be statically loaded with 200 kg (5:1 safety factor) and dynamically loaded with 142 kg (7:1 safety factor).

When flying a system, the working load must be lower than the resistance of each individual flying point in the enclosure, as well as each box. Hanging hardware should be regularly inspected and suspect units replaced if in doubt. This is important to avoid injury and absolutely no risks should be taken in this respect. It is highly recommended that you implement an inspection and maintenance program on flying elements, including reports to be filled out by the personnel that will carry out the inspections. Local regulations may exist that, in case of accident, may require you to present evidence of inspection reports and corrective actions after defects were found.

Absolutely no risks should be taken with regards to public safety. When flying enclosures from ceiling support structures, extreme care should be taken to assure the load bearing capabilities of the structures so that the installation is absolutely safe. Do not fly enclosures from unsafe structures. Consult a certified professional if needed. All flying accessories that are not supplied by D.A.S. Audio are the user's responsibility. Use at your own risk.

### Introduction

Altea series models feature 2x M8 nuts on the top panel. There are 4x M8 nuts at the rear panel.

Flying with eyebolts is very economical and safe, and it is recommended for installations where the boxes are not fixed permanently.

The illustration shows the internal metal hardware of an enclosure with eyebolt flying.

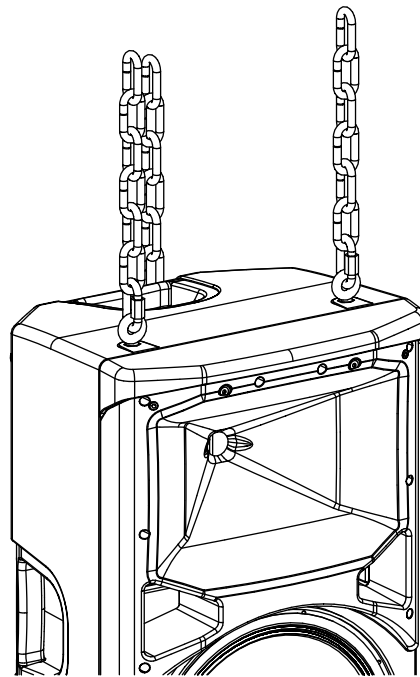

## Flying with eyebolts

Each rigging point has a 30 kg (66 lb) working load limit. Then choose the slings or chains of required load resistance and length, bearing in mind that the length difference between the front and back slings or chains will determine the vertical orientation. Alternatively, the back bottom eyebolt points can be used to provide vertical orientation.

The *ANL-1* set is an optional set of four eyebolts and three carabiners. (Dimensions are in millimeters).

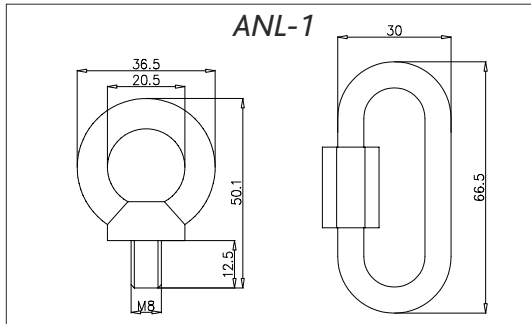

Each *ANL-1* eyebolt has a rated working load of 140 kg. (308 lb). Each *ANL-1* carabiner has a working load of 910 kg (2002 lb). If using other hardware, make sure it is rated to handle the required load.

When using eyebolts it is important to bear in mind that the rated working load is only true for a load applied in the plane of the eye, and is significantly reduced for other angles. The drawing illustrates the concept. The table shows the variation of the working load as a function of the load angle. In the case of the *ANL-1* eyebolt, this means that the 30 kg working load becomes 9 kg at 45 degrees. Do not use eyebolt flying if the load angle is higher than 45 degrees.

	0 Degrees	30 Degrees	45 Degrees	More than 45 Degrees
% Working load	100%	65%	30%	25%

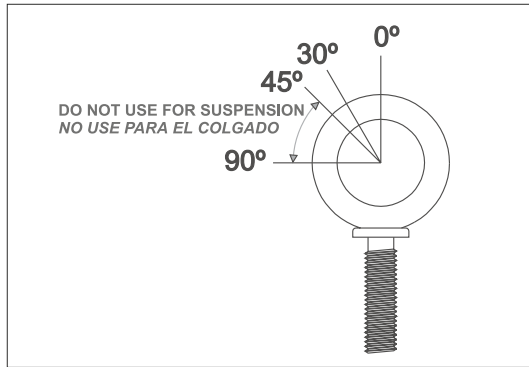

The following illustrations show different views on eyebolt flying for a single box. The length of the back cables or chains determines the vertical angle of the box.

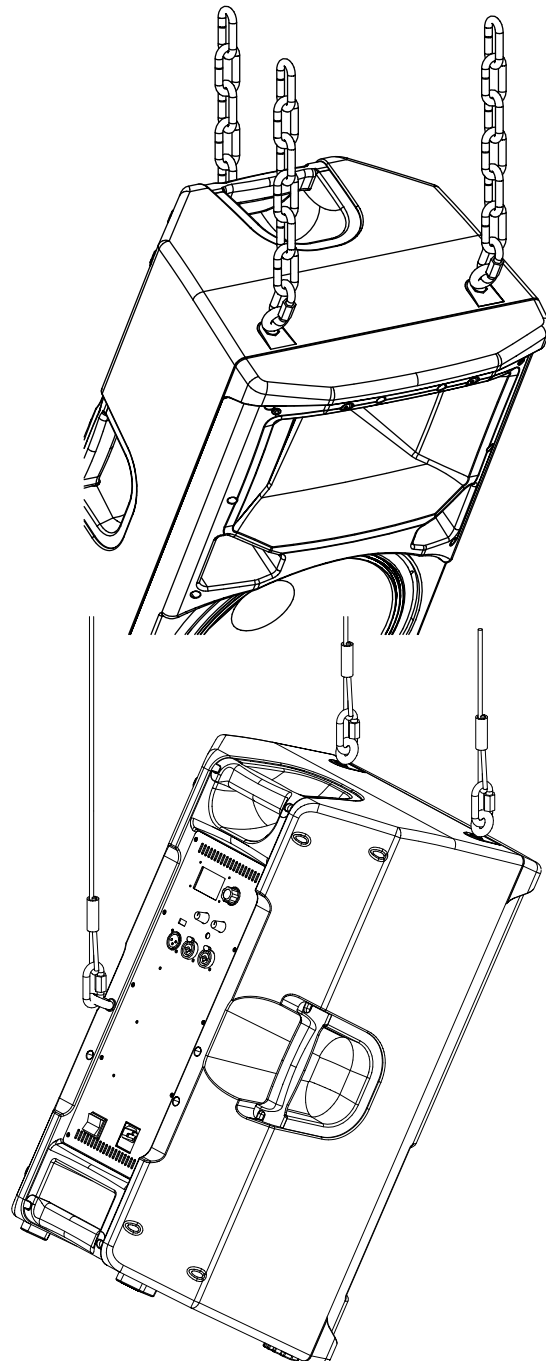

## APPENDIX: Line connections: unbalanced and balanced

There are two basic ways to transport an audio signal with microphone or line level:

**Unbalanced line:** Utilising a two conductor cable, it transports the signal as the voltage between them. Electromagnetic interference can get added to the signal as undesired noise. Connectors that carry unbalanced signals have two pins, such as RCA (Phono) and 1/4" (6.35mm, often referred to as jack) mono. 3 pin connector such as XLR (Cannon) may also carry unbalanced signals if one of the pins is unused.

**Balanced line:** Utilising a three conductor cable, one of them acts as a shield against electromagnetic noise and is the ground conductor. The other two have the same voltage with respect to the ground conductor but with opposite signs. The noise that cannot be rejected by the shield affects both signal conductors in the same way. At the device's input the two signals get summed with opposite sign, so that noise is cancelled out while the programme signal doubles in level. Most professional audio devices use balanced inputs and outputs. Connectors that can carry balanced signal have three pins, such as XLR (Cannon) and 1/4" (6.35mm) stereo.

The graphs that follow show the recommended connection with different types of connectors to balanced processor or amplifier inputs. The connectors on the left-hand side come from a signal source, and the ones on the right hand side go to the inputs of the processor or amplifier. Note that on the unbalanced connectors on the left-hand side, two terminals are joined inside the connector. If hum occurs with balanced to balanced connections, try disconnecting the sleeve (ground) on the input connector. Note that the illustrations show what should be connected to what, but that pin locations on an actual XLR connector are different. Also, pin 2 hot is assumed on XLR connectors.

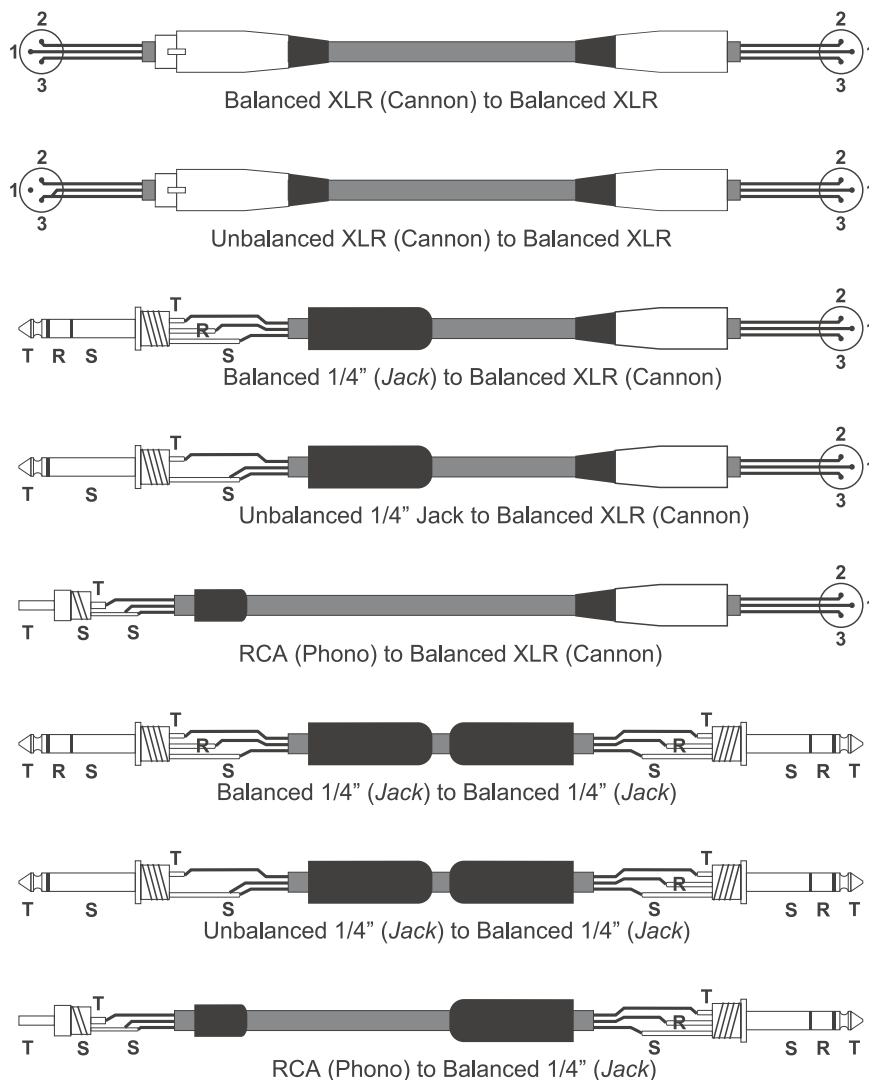

[www.dasaudio.com](http://www.dasaudio.com)



**D.A.S. AUDIO, S.A.**  
C/. Islas Baleares, 24  
46988 Fuente del Jarro  
Valencia, SPAIN  
Tel. 96 134 0525  
Tel. Intl. +34 96 134 0860  
Fax 96 134 0607  
Fax Intl. +34 96 134 0607

**D.A.S. AUDIO OF AMERICA, INC.**  
Sunset Palmetto Park  
6816 NW 77th Court.  
Miami, FL. 33166 - U.S.A.  
TOLL FREE: 1-888DAS4USA  
Tel. +1 305 436 0521  
Fax +1 305 436 0528

**D.A.S. AUDIO ASIA PTE. LTD.**  
25 Kaki Bukit Crescent #01-00/02-00  
Kaki Bukit Techpark 1  
Singapore 416256  
Tel. +65 6742 0151  
Fax +65 6742 0157