



Machines for
Musicians

Modal Electronics 002R

8 or 12 voice polyphonic analogue/digital hybrid synthesiser

User Manual

OS Version - 1.3



Important Safety Information



WARNING – AS WITH ALL ELECTRICAL PRODUCTS, care and general precautions must be observed in order to operate this equipment safely. If you are unsure how to operate this apparatus in a safe manner, please seek appropriate advice on its safe use.

Please ensure you read this manual and the Modal 002R 'Quick Start Guide' before attempting to operate this apparatus.

THIS APPARATUS IS HEAVY – observe lifting and handling precautions when moving it. Also ensure that the apparatus is placed on a suitable stand or rack unit so as to enable safe operation and prevent toppling.

This apparatus **MUST NOT BE OPERATED NEAR WATER** or where there is risk of the apparatus coming into contact with sources of water such as sinks, taps, showers or outdoor water units, or wet environments such as in the rain. Take care to ensure that no liquids are spilt onto or come into contact with the apparatus. In the event this should happen remove power from the unit immediately and seek expert assistance.

Be careful to allow free air movement around the apparatus and do not block any air vents or exits during operation - this apparatus produces heat.

This apparatus produces sound that could cause permanent damage to hearing. Always operate the apparatus at safe listening volumes and ensure you take regular breaks from being exposed to sound levels

THERE ARE NO USER SERVICEABLE PARTS INSIDE THIS APPARATUS. It should only be serviced by qualified service personnel, specifically when:

- The apparatus has been dropped or damaged in any way or anything has fallen on the apparatus
- The apparatus has been exposed to liquid whether this has entered the apparatus or not
- The power supply cables to the apparatus have been damaged in anyway whatsoever
- The apparatus functions in an abnormal manner or appears to operate differently in any way whatsoever.

00. Introduction	6
01. I just want to play this thing...	8
Power on	9
Screen Controls	10
Patch Screen	12
Load Patch	13
Patch storage	14
02. Connections	16
03. Synthesis Engine	18
Oscillators	20
Mixer	22
Filter	24
Envelopes	26
LFO's	28
Modulations	30
04. Keyboard and Quick Recall	32
Key Modes	33
Keyboard	34
Mod Wheel	36
MPE	38
Quick Recall	40
05. Sequencer, Animator and Arpeggiator	42
Sequencer	44
Animator	48
Arpeggiator	50
Modes	51
06. Multi-Timbrality	52
Performance Mode	53
Performance Edit	54
Performance Storage	56
07. Snapshot	58
08. Digital Input/Output Board	60
09. Settings	70
10. Web User Interface	84



00

Introduction

Modal 002R is an 8 or 12 voice analogue-digital hybrid synthesizer.

It features two high-resolution NCO oscillators per voice (plus two sub oscillators), Modal-designed four-pole transistor ladder filter with real analogue morphing, VCA, two LFOs, 2 modulation matrices and very powerful Sequencer and Arpeggiator.

The hardware has been manufactured to fit in a 3U 19" rack and features a high quality steel chassis, aluminum turned encoders and high quality 4.3" LCD screen.

Among the many connections, Modal 002R features an ethernet port to connect your synth to your network and enable updates via the internet (no need for MIDI sysex dumps) and also access to the Modal cloud features and HTML Web User Interface.

Please update your unit immediately

Internet connectivity is a key-point for Modal products: we release updates on a regular basis, constantly providing new features and bug fixes.

Please read 'Settings' (chap.9) for a more detailed description of the update procedure.

IMPORTANT

Please allow at least 1U of space above and below your synthesiser to allow heat to escape when in normal use

01

I just want to play
this thing...

Power on

Connect the power lead to your 002R then connect the output of the 002R to your mixer, or if you prefer connect your headphones.

Also connect an ethernet cable from your router to the 002R.

In order to maintain a high Signal to Noise Ratio the voices are alternatively split left and right (eg. 12 voices are split 6 voices on the left and 6 on the right), so we recommend panning the two channels slightly off centre on your mixer or audio interface.

Before powering up ensure the volume control is at minimum, analogue electronics during first power on create a 'pop' and this may cause damage to your speakers and the sound guy's ear drums.

Then power on.

You will see a progress bar on the screen. When the synth has loaded it will change to show the main patch page.

Play a key on your MIDI master keyboard and slowly turn up the volume to a comfortable level.

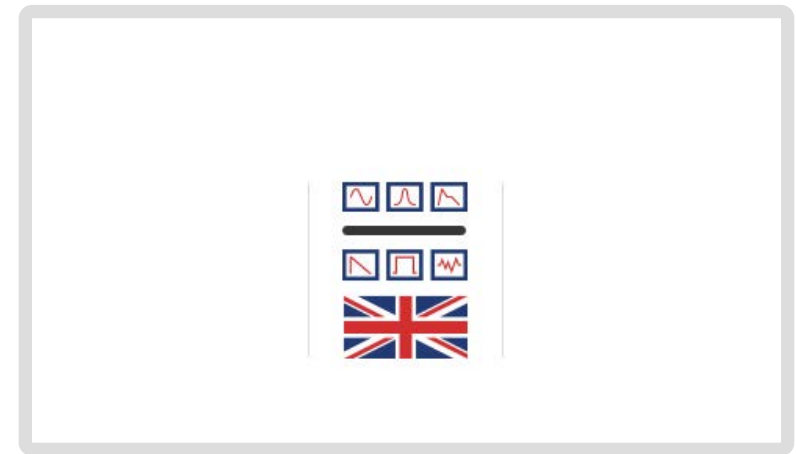

Screen controls

The Modal 002R interface is designed to be extremely intuitive and easy to use, so that all the most important parameters are easily accessible and tweakable.

P1, P2 and P3 Controls

By default the three encoders to the right of the main 'screen controls' can be used to quickly navigate around the interface. P1 controls what page is shown, P2 can be used to select a parameter on that page and P3 can be used to change the value of that parameter.

They can be also used to load patches, sequences etc. P3 will scroll through the patch database and turning P2 once will load the currently selected patch.

Keypad

Hover mode

You can use the keypad to select a specific parameter box on the screen - you can see the subscript numbers shown in the bottom left of every box in every screen page (except for the patch loading page).

Edit mode

You can use the keypad to type the value of that parameter.

Key 0

In hover mode on every page key 0 is assigned to the 'X' exit button. In edit mode typing 0 before entering other values allows for minus numbers to be entered. For example typing 0, 2, 4 would make -24.

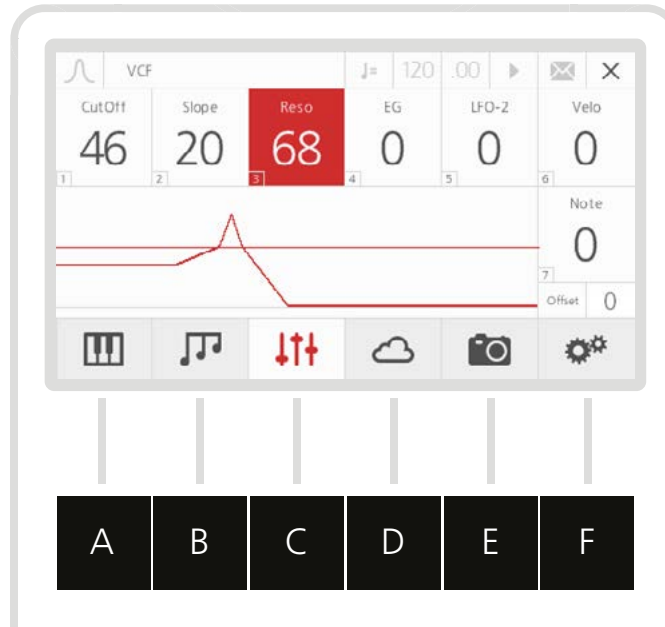
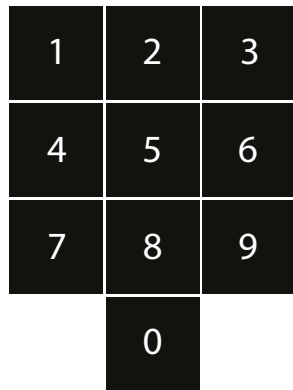

Hover mode

Grey cursor and text.
Turning datawheel and +/- navigates around the screen to different parameters. Keypad can be used to shortcut to specific parameters and enter edit mode. Push datawheel or press select to switch to edit mode.

Edit mode

Red cursor and white text.
Turning datawheel and +/- changes values of currently selected parameter. Keypad can be used to type parameter values. 0 followed by a number is a minus. Push datawheel or press select to switch to hover mode.

Select button

Alternative to pushing datawheel, up to user's preference. Select is mainly used for switching between hover / edit mode. So you navigate to a parameter in hover mode then press select to edit the value. It is also used to load patches.

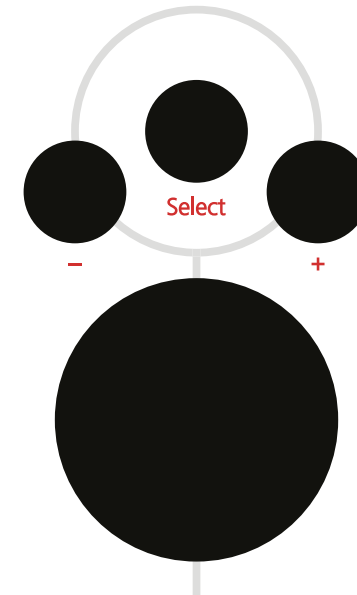

+ / - buttons

Alternative to turning datawheel. Pushing once increments one step. Pressing and holding repeats increments.

Datawheel

Large rotary encoder for data selection and entry. Turning clockwise increments, anti-clockwise decrements and pushing selects. Same functionality as the Select and + / - buttons.

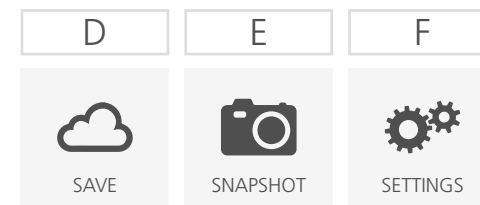
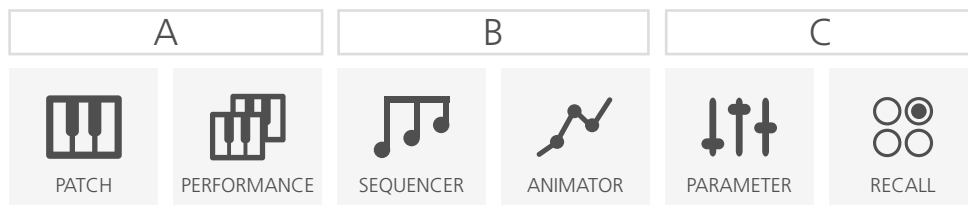

Menu buttons

6 buttons below the screen to navigate quickly to different sections. Some are dual function, where pressing twice will bring up other pages. Links up to bottom menu of the screen



Patch screen

After power on you will be shown the Patch screen. This screen shows you the currently selected patch, as well as some useful details about the current patch.



- Patch Number** - is always shown as 4 digits (0000), the first two digits represent the bank number (00xx - 99xx) and the last two the patch number (xx00 - xx99) within the bank. There are 100 banks of 100 patches in total (0000 - 9999). If the patch number is highlighted in red then it is the currently loaded patch number.
- Patch Name** - Patch names can be up to 32 characters long.
- Keyboard Transpose** - the keyboard section shows the current octave and transpose settings for the current patch. The numbers on the keys show the midi note value for each octave, so in the example above C2 to C7. We use C4 as middle C (MIDI note 60) but the red value on the right shows the current note on middle C with octave and transpose applied.
- Midi Channel** - the current midi channel 002R receives and sends on. This can be changed in the Settings > MIDI menu.
- Key Mode** - Polyphonic, Monophonic, Unison or Stack. Within the graph each line represents a voice, each different height the number of notes that can be played at once and the gap between the lines the detune amount (only used on Unison and Stack).
- Arpeggiator Status** - whether arpeggiator is currently on or off
- Animator Status** - whether animator is currently on or off



Load patch

If you want to load another patch:

- Scroll through the patches either using the Datawheel, or the '-/+' buttons above, or directly type the slot patch number with the keypad
- Now you see a different patch name, but no new patch has been loaded yet (the patch number on the left of the screen is grey). If you want to actually load it, press the Select button to confirm your selection: the patch is now loaded (the number is red)
- If you don't want to load a new patch, but just scroll through the patch names, you can keep turning the Datawheel (or pressing the '-/+' buttons) without any harm (the patch number will remain grey)
- You can use the first 'menu button' (A) as an 'Escape' button. If you have scrolled past the current patch, pressing that button returns you to the current patch name (without re-loading it, so you will not lose your edits). The patch number is now red.

Another way to load patches is to use the 'Quick Patch Load' method. While holding down the first 'menu button' (A) you can press the '-/+' buttons to load the next or previous patch.

This method can also be used on any page, not just the patch page and will not switch page when the new patch is loaded. This can be useful if for example you would like to see the filter settings of the previous patch you can stay on the VCF page when switching between patches.

Patch storage

When a sound has been edited an asterisk (*) will appear at the beginning of the name to let you know that there are unsaved changes.

Then if you would like to save that sound:

- Press the 4th 'menu button' (D) - the LCD will display the storage page. You can save many different types of data (including Performances, Sequences, etc.), but since you are working on a mono-timbral patch, the screen will automatically select Patch Storage.

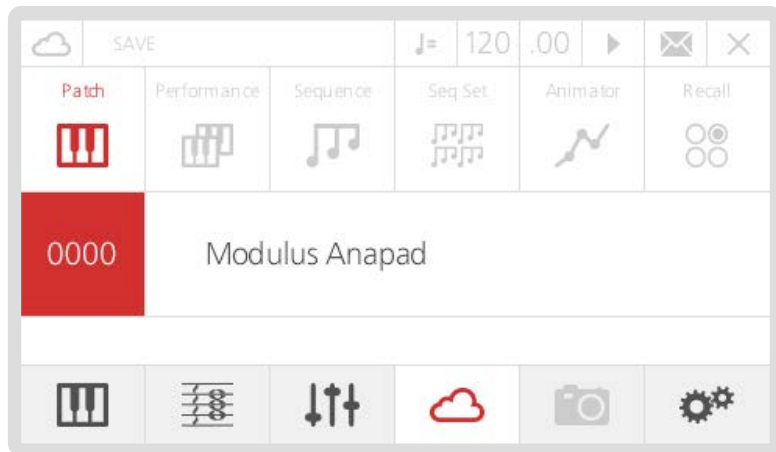

- If you want to save the edited sound in the same slot (overwriting the previously saved patch) just press Select.
- Alternatively, if you want to save the sound in a different slot, you can select one by either using the datawheel or the '-/+ ' buttons. Once you found the right slot, press Select to confirm.
- Now the LCD shows the QWERTY keyboard, where you can type a new name for the preset. Using the datawheel (which can also be tapped to confirm selection) is probably the easiest way to type the name. Once you are done, just scroll down to the 'Done' box and confirm.

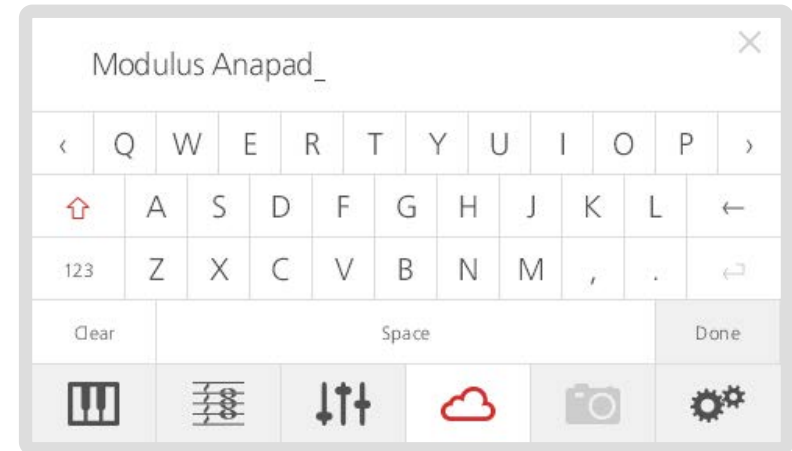

- You will need to confirm what you have just typed, so press number '2' on the keypad (or Select again), which corresponds to the 'Yes' box. If you are not sure about the name, type '1', which corresponds to the 'No' box.

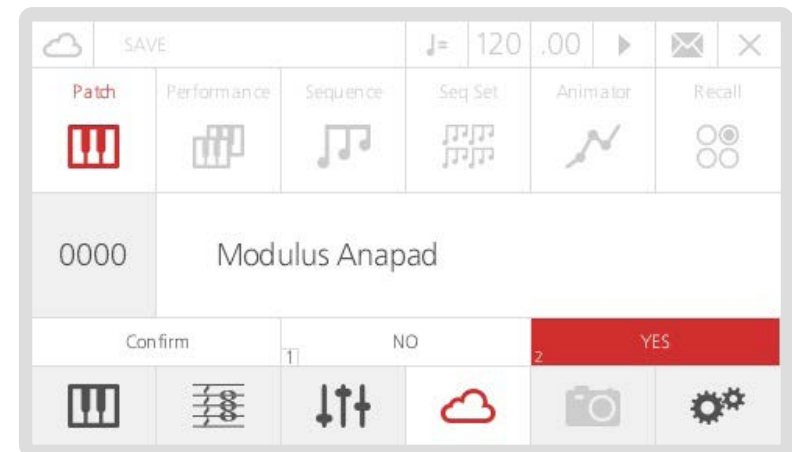

Please note, Patches are saved with a link to the current Animator number and (if the Link option is on) the current Sequence number. However, if an Animator or Sequence has been edited those changes will not be saved, they would be need to be saved seperately with the Animator / Sequence in that slot number.

02

Connections

Headphones

(On the front) A 1/4" stereo jack socket. We recommend using headphones with a minimum impedance of 70 ohms.

Audio In

Two mono TS audio inputs, to process your audio source with 002R's analogue VCF and VCA.

USB-B (Audio, MIDI)

This USB-B port is part of the optional digital input/output board only, and allows the synth to appear as a USB Audio/MIDI device on a computer, providing both audio/MIDI inputs and outputs

MIDI (In, Out, Thru)

To receive/send/pass through MIDI data from/to other devices.

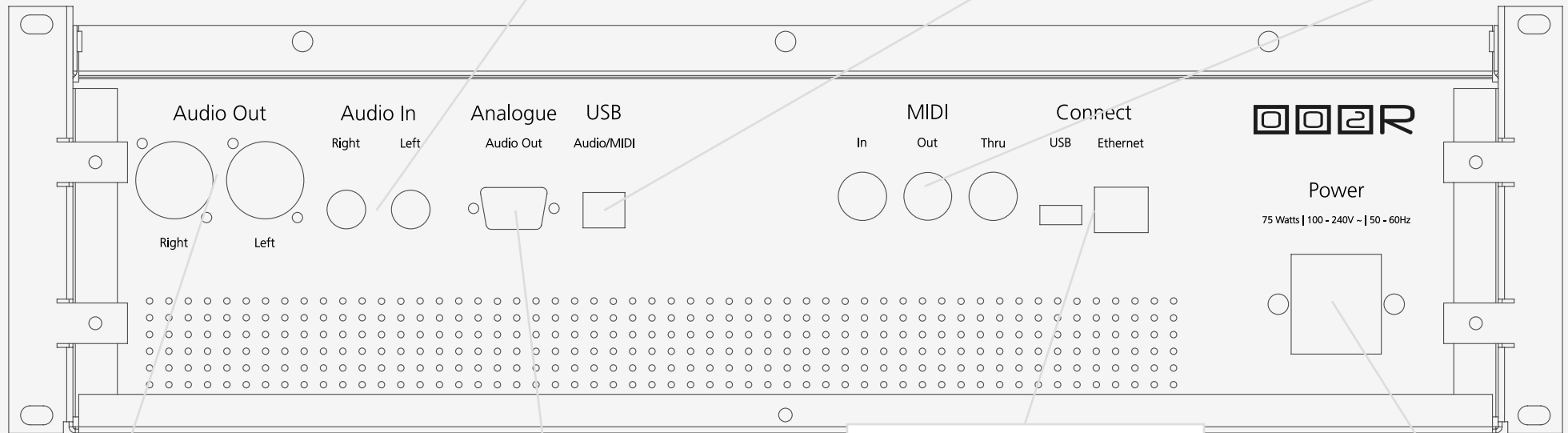

Audio Out

002R's main audio output, featuring a stereo 'combo-socket' outputs with balanced XLR or unbalanced TS plugs. With the standard version of the Modal 002R, six voices are hard-wired to the left, six voices to the right. The option digital output card will enable internal mixing and panning.

Analogue Out

D-Sub connector providing individual pure analogue output for each of the 12 voices.

Connect

Internet connection. Connect an Ethernet cable directly to your router to allow updates to the OS, access to the Web Editor and other internet features.

The USB-A port is used for connecting class-compliant USB-MIDI devices and allows MIDI in/out connections. Devices should be connected directly rather than through a USB hub.

Power

AC power inlet, accepting standard grounded IEC power cord. It operates over a range of 90 to 260 volts and 50 to 60 Hz. Connect the cord included with your 002R, then press the power switch on the front panel to turn the synth on.

03

Synthesis engine

In this section we are going to have an in-depth look at every section related to the sound engine of the 002R.

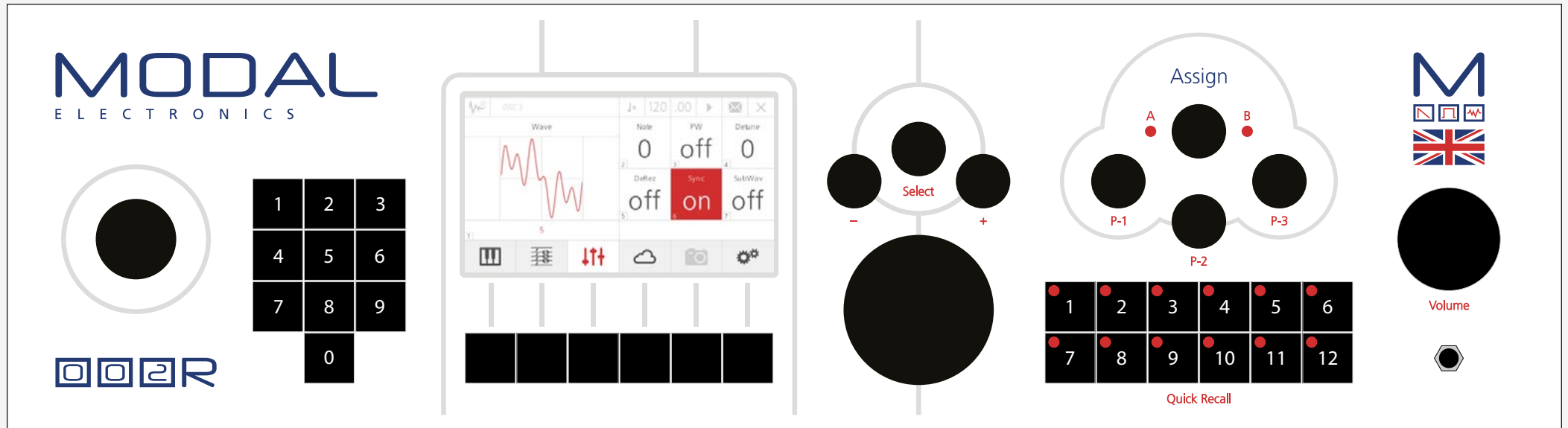

002R features two main digital oscillators per voice (Numerically Controlled Oscillators - NCO), identified by OSC1 and OSC2 labels, each one with its own Sub-Oscillator.

NCOs differ from the oscillators found in most virtual analogue synthesisers in that they use a variable sample rate and as such are not band-width limited. This means that a sawtooth sounds like a sawtooth regardless of the pitch played and results in a very rich sound, previously only obtainable from classic analogue synthesisers.

1. **Wave/PW:** Allow you to choose among 56 different waveforms, ranging from classic analogue sounds to more unique digital shapes.
2. **Note:** Control the tuning of each oscillator in semitones, covering a range from -24 to +24 semitones.
3. **PW:** If the underlying PW switch is on, the oscillator is in PulseWave mode: this means that now the Wave parameter acts as a pulsewidth control, with maximum value of 63 corresponding to a squarewave.
4. **Detune:** This parameter controls the fine tuning of the oscillators, with the maximum value of 127 corresponding to about a semitone.
5. **DeRez:** When this option is On, a down sampling algorithm is active on both the oscillators. This algorithm adds a good amount of additional high-frequency harmonics, in order to make the sound brighter (tip: very good with waveforms from 30 to 45).
6. **Sync:** When this option is On, the two oscillators are hard-synced. OSC2 is the slave oscillator: you can detune it or modulate its pitch, but it will always follow OSC1 pitch.
7. **SubWav:** This option controls the sub-oscillators behaviour. Each sub-oscillator is linked to a main oscillator, sounding one octave lower.
 - When the SubWav button is off, the sub-oscillators produce standard square waves.
 - When the SubWav button is on, the sub-oscillators use the same waveforms as the corresponding main oscillator.

This is a key feature of the 002R, this is more like having 4 oscillators per voice rather than the traditional 2 oscillators. Combining SubWave and DeRez functions when creating sounds allows you to create a variety of harmonic contents for the oscillators

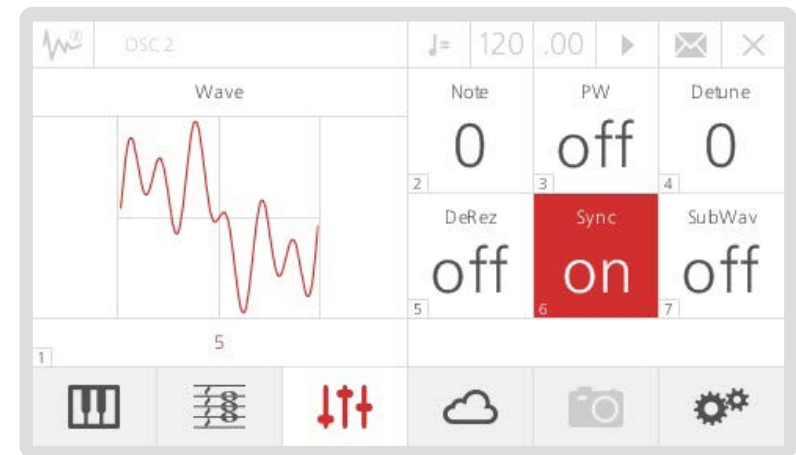

You can easily mix the signals coming from the oscillators in the Mixer section.

1. **Osc1:** This parameter controls the volume coming from Oscillator 1, with a range from 0 to 127.
2. **Osc2:** This parameter controls the volume coming from Oscillator 2, with a range from 0 to 127.
3. **Ext In:** This parameter controls the volume of the incoming external audio signal, if there is an external source connected to the 002R's Audio Input. In this way, you can process any instrument producing a 'line' signal (e.g. a drum machine, another synth or DAW output) with our VCF and VCA, through a pure analogue signal path.

Due to hardware restrictions, only 4 voices can be used for processing external audio, so please make sure that this parameter is always equal to 0 if you do not need it. In Patch Mode, If Ext-In is greater than 0, then only 4 voices will be available, no matter what your KeyMode and Size settings are (see 'Keyboard' paragraph in ch.4).

4. **Sub1:** This parameter controls the volume coming from the Sub-Oscillator linked to Oscillator 1, with a range from 0 to 127.
5. **Sub2:** This parameter controls the volume coming from the Sub-Oscillator linked to Oscillator 2, with a range from 0 to 127.
6. **Drive:** This parameter controls the amount of filter overdrive distortion. Note that 002R features a transistor ladder VCF with a distortion circuit that overdrives the filter itself, not the signal 'before' the filter. This makes our VCF sound like nothing else, and also creates a particular effect: indeed you could hear a sort of 'hiccup' if moving the Drive encoder too fast. Don't panic: this is the normal behaviour of our design, and is due to the transistors saturating and then recovering.

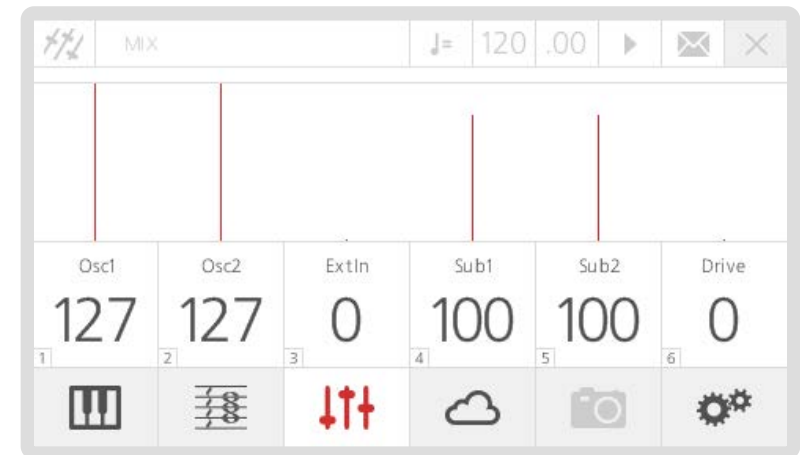

Modal 002R uses a classic analogue transistor ladder design to low-pass filter the signal coming from the oscillators (or from an external source). Like every true polyphonic synthesiser, Modal 002R has an individual VCF per voice.

- Cutoff:** This parameter controls the low-pass filter cutoff frequency. The minimum value (i.e. 0) corresponds to about 40 Hz.
- Reso:** This parameter controls the amount of resonance of the filter. Note that with the ladder filter design, resonance can go quite wild at high values; also, turning up the resonance value dampens the low end of the sound a little bit. These are normal consequences of this particular filter design.
- Slope:** This parameter controls the shape of the filter: note that this is a real continuous analogue filter morphing (quite a unique feature in the analogue domain), which gives to the Modal 002R filter a unique characteristic.
 - At a value of 0 you have a 4-pole low pass filter;
 - At a value of 10-20, you have a sort of low-shelving;
 - In the midpoint (63) you have a band-pass filter;
 - At maximum value (127) a 1-pole low-pass filter.

TIP: With this feature you can dampen the low frequencies while maintaining a rich high-end texture. For a good 'light' pad sound, try a value of 90 with a high Cutoff. Try values other than 0, 63, and 127 for interesting, unique timbres.

- EG:** This parameter controls the amount of envelope modulation ('VCF-EG' - see 'Envelopes' section in this same chapter) on the filter cutoff frequency. Note that this parameter can also have negative sign. TIP: use a high negative EG value combined with a long Release on the Envelopes, in order to get some nice 'filter-opening' effects when releasing the keys.
- LFO2:** This parameter directly controls the amount of LFO2 modulation (see 'Modulations' section - later in this same chapter) on the filter cutoff frequency. Note that this parameter can also have negative sign.
- Velocity:** This parameter controls the amount of keyboard velocity modulation on the filter cutoff frequency: at positive values, the stronger you press the keys, the higher the cutoff is set. Note that this parameter can also have negative sign.
- Note:** This parameter controls the amount of keytracking modulation on the filter cutoff frequency: at positive values, the higher the note you press, the higher the cutoff is set. Note that this parameter can also have negative sign.
- Offset:** This parameter controls the keytracking offset when using Note to CutOff modulation. The offset is in semi-tones from the lowest note on the keyboard.



Modal 002R provides two separate classic 4-stage contour generators (i.e. envelopes), one for the filter (VCF-EG), one for the amplifier (VCA-EG): the former modulates the filter cutoff frequency, if a value different from zero is set for the filter EG parameter (see 'Filter' section - previously in this same chapter); the latter modulates the amplifier volume, if a value different from zero is set for its own Amount parameter.

Both the envelopes have the same 4 stages, plus 2 options:

1. **Attack:** This parameter controls the time passing from the moment you press a key (i.e. 'MIDI Note On' message) until the sound reaches its maximum value
2. **Decay:** This parameter controls the time passing for the sound to drop from its maximum value to a sustain level (see later)
3. **Sustain:** This parameter controls the level of the sustain phase of the sound (i.e. the volume of the sound while keeping the key pressed). If there are no modulations active, this volume keeps constant until you leave the key (then entering the 'release' phase)
4. **Release:** This parameter controls the time passing from the moment you leave a key (i.e. 'MIDI Note Off' message) until the sound reaches silence
5. **Shape:** This parameter varies the shape of certain stage of the envelope. You can choose between 'Linear' mode (where all the stages have linear shape), or 'Exponential' mode (where Decay and Release have exponential shapes, but the Attack stays linear). The 'Exponential' mode is also faster than the 'Linear': it gives the ability to create snappier transients, thus it is the best mode for percussive sounds design. On the other hand, 'Linear' may be preferred when designing pad/ambient sounds.
6. **Retrigger:** in single ('sngl') mode the envelope behaves like an analogue envelope: when a key is pressed as the envelope is decaying, the attack phase will start from that level rather than 0 (so if the envelope hasn't reached 0, it will start from there). On the other hand, when this is in retriggering mode ('trgr'), a new key being pressed will force the envelope level to 0 and start the attack phase again (particularly useful for bass/lead mono/unison sounds).

Shape and Retrigger parameters are not on the front panel and are accessed using the screen controls.

The VCA-EG has one other different parameter available:

7. **Amount:** This parameter controls the amount of contour generator applied to the VCA. If this parameter is set to 0 you hear silence, while turning it up causes the volume to increase.

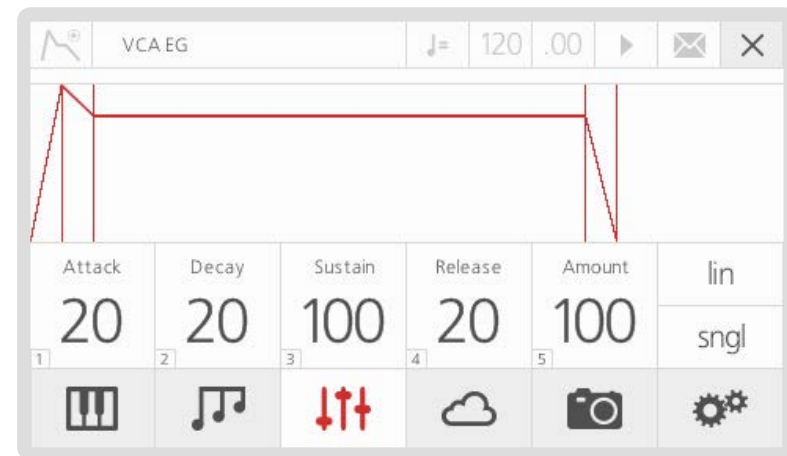

Modal 002R features two individual low frequency oscillators: LFO1 is a simple LFO and is 'global' across the patch (so it affects the whole sound); LFO2 has more parameters and is applied 'per voice' (so it affects each note/voice individually). Both LFO1 and LFO2 have these parameters:

1. **Waveform:** Allows you to choose one among the four available LFO waveforms (i.e. sine, sawtooth, square and sample & hold).
2. **Rate:** This parameter controls the speed of the LFO.
3. **MIDI Sync:** This parameter syncs the speed of the LFO to either the internal or an external MIDI clock. The clock source can be selected within the 'MIDI Settings' page. When enabled the 'Rate' parameter changes to show divisions of a typical 4/4 bar, so 1/4 would be a crotchet, 1/2 would be a minim etc.

LFO2 has these additional parameters:

4. **Delay:** This parameter controls the initial delay of the LFO. The LFO is initially silent, then it's amplitude increases until it reaches its full amplitude and keeps constant: 'Delay' regulates the time needed to complete this initial phase.
5. **Note:** This parameter controls the amount of the keytracking modulation on the LFO speed: at positive values, the higher the note you press, the faster the LFO runs.
6. **Sngl:** This button switches between the LFO's different modes:
 - Reset:** in this mode, each new keypress restarts the LFO and it continues to run - particularly useful for Unison/Stack sounds
 - Freerun:** in this mode LFO2 is never reset, so it could be at any phase when a note is pressed
 - Reset + Single:** in this mode, LFO2 will start when a new key is pressed, do one cycle and stop, but when a new note comes in and one is already playing, LFO2 is retriggered
 - Single:** in this mode, LFO2 will start when a new key is pressed, do one cycle and stop, but will not retrigger when a new note comes in and one is already held (like in Mono/Unison key modes)
7. **Speed Hi / Low:** when this parameter is set to "High", LFO2 runs at 3 times the speed of "Low" mode.
8. **Bi / Uni polar mode:** if Unipolar, the LFO will outcome only positive modulation values, while Bipolar is a more common negative-positive. Particularly useful for the Square waveform.

Note that LFO1 is slower than LFO2, allowing modulations that are impossible to do with LFO2, more suitable for pad/ambient sound design.

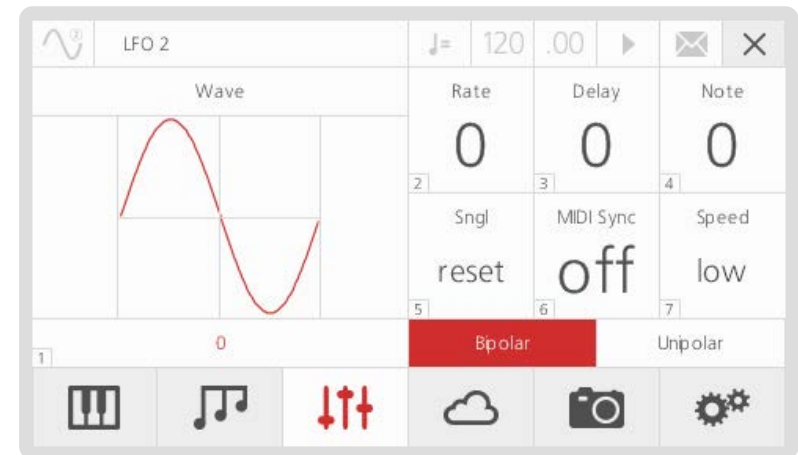

The Modal 002R has six main modulation matrices, each source has 8 destinations, with a single Depth value for each source, apart from LFO2 where each destination has a depth value and a global depth value.

Sources: The available sources are LFO1, Aftertouch, Modulation Wheel, LFO2, Velocity and Note (Keytracking).

Destinations: Modulation destinations are almost the same for all matrices, with the only difference being Reso as a destination for LFO2, Velocity and Note (Keytracking) instead of Cutoff. This is because LFO2 already has a hard-wired modulation for the filter cutoff (see 'Filter' section - previously in this same chapter), so having it also on the matrix would be a duplicate.

More details:

1. **Depth:** The global modulation amount for the source, can be positive or negative
2. **OSC1/ OSC2:** Are the pitches of the two oscillators. Modulation sources LFO1 and LFO2 directly control each oscillators pitch. However, modulation sources AfterTouch, ModWheel and Velocity enables a vibrato effect on each oscillator, specifically it assigns LFO2 to the oscillators pitch with an independant depth amount. Finally modulation source Note fixes the pitch of an oscillator when enabled, which can be useful for percussive or sync sounds.
3. **Wave1/ Wave2:** Are the waveforms of the two oscillators. Modulating this destination means that the oscillator will step through the different waveforms (see 'Oscillators' section - previously in this same chapter)
4. **Slope:** Is the shape of the filter (see 'Filter' section - previously in this chapter)
5. **Reso:** Is the resonance of the filter (see 'Filter' section)
6. **Cutoff:** Is the cutoff frequency of the filter (see 'Filter' section)
7. **Drive:** Is the amount of overdrive distortion (see 'Mixer' section - previously in this chapter)
8. **VCA:** Is the volume of the amplifier (see 'Envelopes' section - previously in this chapter) - you can create a classic tremolo effect if applying LFO1 to this, or a more complex polyphonic tremolo if applying LFO2.

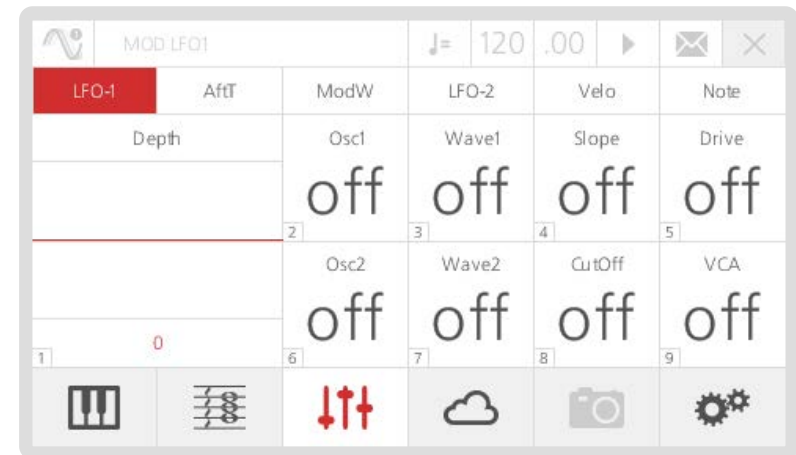

04

Keyboard and Quick Recall



Key Modes

The KeyMode option sets the keyboard polyphony and the allocation method for the voices. 002R has 4 different KeyModes:

- **Poly:** standard polyphonic mode, where you can play up to 8 or 12 notes simultaneously (depending on your 002R version), each one using one single voice and uses most recent note priority
- **Mono:** standard monophonic mode, where you can play just one note at time, using just one voice
- **Unison:** standard unison mode, where you can play just one note at time (mono keyboard), but you can use up to 8 or 12 notes simultaneously (depending on your 002R version) for that note
- **Stack:** special 'poly/unison' mode, where you can decide how many notes you can play together (polyphonic keyboard) and also how many voices the Modal 002R uses for each note. E.g. On a 12 voice 002R with a Size of 4 voices, you can play up to 3 notes simultaneously, with each note using 4 voices, because you have 12 voices available. This mode uses most recent note priority

1. **Glide:** this parameter controls the speed with which the oscillators change their pitch, 'sliding' from one note to the next one pressed:
 - a large value will mean the 'glide' takes longer to reach the new note
 - a shorter value will result in a quicker 'slide'
2. **AutoGlide:** this parameter controls the mode of the glide unit. In 'auto' mode the glide circuit is enabled only when overlapping notes are played, also known as legato. In 'normal' mode the glide circuit is always enabled.
3. **Chord:** This allows you to transpose a stored chord when pressing a single key. The key held down is the root note of the chord. To turn on chord mode hold down a chord on the keyboard, via MIDI-in, or via the sustain pedal to set that chord to be transposed when playing notes (via the keyboard, MIDI-in, arpeggiator, and sequencer) then select the Chord control on the LCD. Chord mode only works in poly and stack modes.
4. **Octave:** this parameter controls the octave shift of the keyboard, allowing you to transpose the whole keyboard by up to 2 octaves up or down
5. **Transpose:** This allows you to transpose the Keyboard, Sequencer and Arpeggiator. To use the function simply hold down the transpose button whilst pressing a key on the keyboard. A 'Zero' transpose is obtained by pressing the third C from the bottom of the keyboard.

A Transpose 'lock mode' is also available: you can double click the transpose button (instead of holding it) to enable the keyboard to be used to transpose playing arps and sequences. Click the button again to unlock.
6. **Size:** (available for both Unison and Stack modes): this parameter controls how many voices the synth is using for a single note
7. **Key Mode:** Select between Polyphonic, Monophonic, Unison and Stack
8. **Spread:** this parameter controls the amount of frequency detuning between the currently used voices (note that this is different from oscillators Detune parameter, which is the amount of frequency detuning between the 2 OSCs in the same voice)

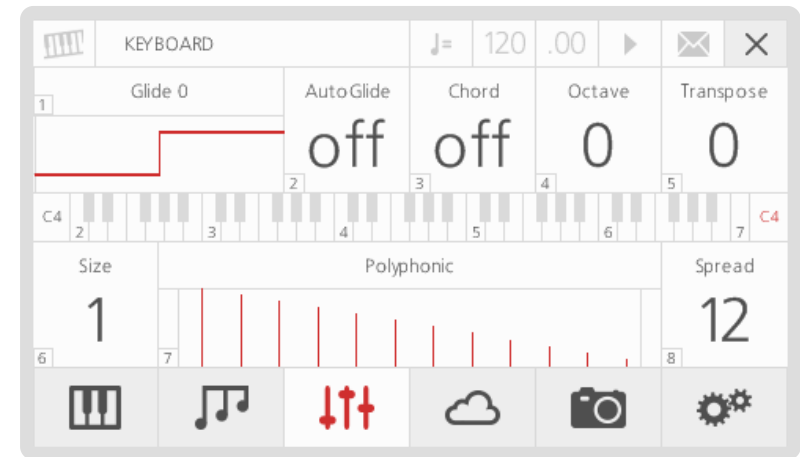



Mod Wheel

On 002R you can receive external Mod Wheel messages from MIDI In as CC 1.

These external Mod Wheel messages can be used to modulate 8 different destinations, as per LFO1, LFO2 etc. (please refer to the 'Modulation' page in chapter 3)

To access the Mod Wheel modulation page first navigate to the Parameters page (menu button C), select Modulation (option 10) and then select the option ModW.



MIDI Polyphonic Expression (or MPE) is a method of using MIDI to enable expressive electronic musical instruments to control multiple dimensions of sound polyphonically. In MIDI, channel-wide messages (such as pitch bend, CCs, and channel aftertouch) are applied to all notes being played on a single channel; therefore, in MPE each note is assigned its own channel so that those messages can be applied to each note individually.

An MPE instrument typically has three axes of expression/control – left-right (X-axis), front-back (Y-axis), and pressure (Z-axis) – each axis can be mapped to a different parameter of sound and be applied on a per-note basis. Examples of MPE-compatible instruments are the ROLI Seaboard, Roger Linn LinnStrument, KMI K-Board Pro 4, HakenAudio Continuum, Eigenlabs Eigenharp, and Madrona Labs Soundplane.

002R is an MPE-compatible synthesiser, which means any MPE instrument can control multiple parameters of its voices polyphonically. The majority of the 002R parameters can be controlled by MPE when the synth is in patch mode (not compatible with performance mode).

Setting up MPE on the 002R

Enabling the 002R to respond to MPE involves the following steps:

- Go to the MIDI Settings page
- Turn on 'MPE Mode'
- Set the MPE Master/Global channel to be that of your MPE instrument
- Go to the MIDI-in subpage, and set the MPE Pitch Bend range to be that of your MPE instrument.

Each MPE dimension is mapped to the 002R voices as follows:

- **Left-right / X-axis (sent as MIDI Pitch Bend)** – by default this controls pitch bend, however this can be changed to control the Joystick X-axis assignments from the MPE Modulation page (see below).
- **Front-back / Y-axis (sent as CC 74)** – by default this controls the 002R's ModWheel modulations assignments, however this can be changed to control just the VCF Cutoff in a relative fashion from the MPE Modulation page (see below).
- **Pressure / Z-axis (sent as Channel Aftertouch)** – this controls the 002R's Aftertouch modulations assignments.

All MPE axis assignments are patch parameters, and are therefore saved and recalled with each patch.

MPE Modulation Page

- **'CC74 to CC1'** – Turn this on to enable MPE CC 74 messages (Y-axis expression) to control the 002R's ModWheel modulation assignments. Else, MPE CC 74 messages will control just the VCF Cutoff in a relative fashion.
- **'PB to JSX'** – Turn this on to enable MPE Pitch Bend messages (X-axis expression) to control the 002R's Joystick X axis assignments. Otherwise, MPE Pitch Bend messages will control pitch bend.



Twelve Quick Recall buttons can be enabled to build lists of patches, sequences and animations etc. that can be quickly accessed or stored.

To load a Quick Recall press and release the button. A list of what is currently on the Quick Recall buttons can be seen on the main Quick Recall page that can be accessed by pressing the third 'menu button' (C) twice.

On this page you can also load a new bank of Quick Recalls, banks can be saved in the same way as patches or sequences and up to 100 banks are available. The bank contains the 12 Quick Recall slots that are present at the time of saving.

To access a slot to edit or load via the screen navigate to the corresponding slot number and press 'Select'.

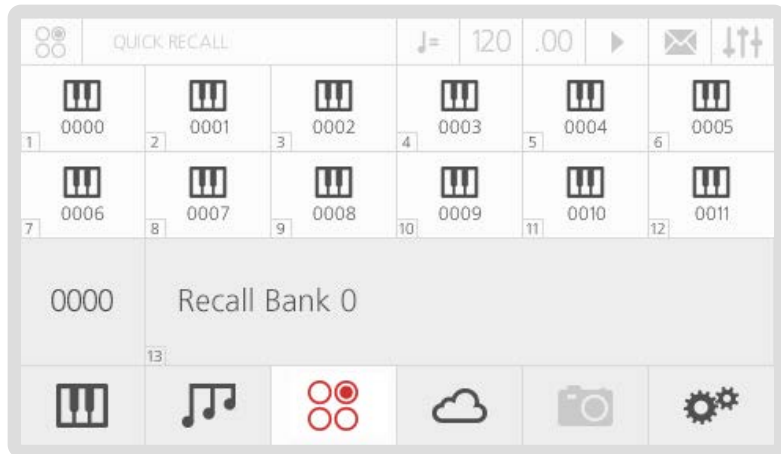

The Quick Recall Slot page shows what is currently on the slot as well as providing options to load or edit the slot.

There are 6 different types of Quick Recall Slot, however currently only Patches are operational:

1. **Patch:** this will load a Patch
2. **Performance:** this will load a Multi Timbral setup, which include up to 12 patches, sequences and animations
3. **Sequence:** this will load a Sequence
4. **Sequence Set:** coming soon
5. **Animator:** this will load an Animation
6. **Recall:** this will load a new Quick Recall Bank

To quickly save a Quick Recall Slot press and hold the Quick Recall button corresponding to the slot number you want to save into.

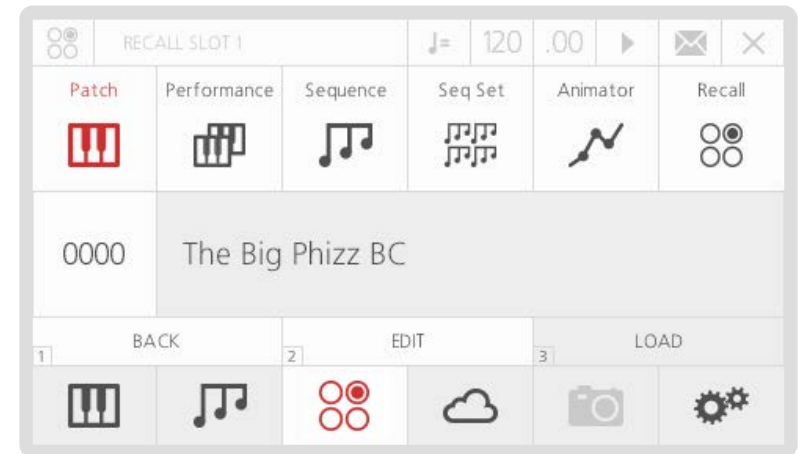

05

Sequencer, Animator and Arpeggiator

In this section we are going to explain three very important features of the Modal 002R: first of all, our very powerful 12 row, 32 step Sequencer; secondly, a unique tool called Animator, a note-triggered sequencer for parameters that allow you to create complex modulations; finally, the 002R's Arpeggiator.

To access the screen page related to the Sequencer or Animator, use the second 'menu button' (B). The Arpeggiator screen is located on the main parameters page, third 'menu button' (C).

On each page there are some key parameters to edit and control each feature:

- the Tempo parameter, (expressed in BPM) controls the speed of the Sequencer, Animator and Arpeggiator. This parameter is located in the top right of the screen, but can only be accessed on certain screens. If the parameter is accessible then the tempo has a darker font colour.
- the Clock start/stop, starts the internal clock, which starts the Sequencer running.
- Backward/Forward buttons, for changing the step position on the LCD (both for the Sequencer and the Animator)
- a Mode parameter, for changing the direction mode of the sequence/animation/arpeggiator
- Up/Down buttons, for changing the two currently displayed rows on the LCD (both for the Sequencer and the Animator)

The Modal 002R Sequencer allows you to create up to 12 simultaneous sequences of up to 32 Steps, each of which allows you to create up to 12 rows of notes or parameter/CC automations.

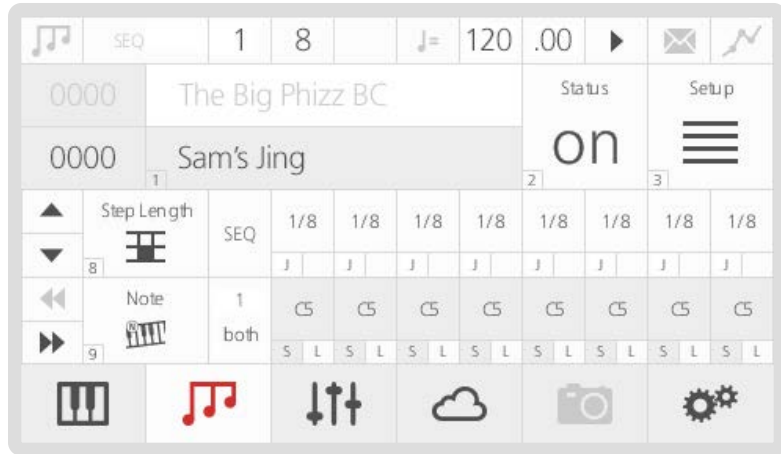

The previous screenshot shows the main Sequencer page on the LCD. On the top row along with the current patch number and name you can find:

1. **Sequence Number/Name:** these two boxes show the current sequence slot number and name which can be used to load sequences in almost the same way that patches are loaded (see chapter 1). You just need to select the Sequence name, scroll through presets and then press 'Select' to confirm.
2. **Link/Status:** this switch acts differently in Patch vs Performance Mode.

In Patch Mode the option is 'Link'. If this parameter is enabled when the current patch is saved then it is saved with a link to the current sequence number. So when the patch is reloaded then the sequence is also loaded.. Please note that only a link to the Sequence number is made, so any edits to the Sequencer would need to be saved separately.

In Performance Mode the option is 'Status'. This switch controls the status of the currently selected sequence for the current part: if On, the sequence is active and it will play as soon as you tap the Tempo knob or external clock; if Off, it will not play, even if you start the Sequencer with the Tempo knob or external clock.
3. **Setup:** this button gives you access to a sub-menu with further controls for sequence editing (see below).

In the top menu after the page title 'SEQUENCER' the current step position of the screen and front panel is shown. Although the step sequencer can have 32 steps only 8 steps can be shown and edited at a time.

Underneath the first row, you can find:

- A set of 4 direction buttons on the left-hand side, for changing the rows (Up/Down arrows) and the 8 steps (Backward/Forward arrows) being displayed on the LCD.
- **Note/Parameter Selection:** these two boxes allow you to select the row function.

On the Sequencer, a row can either play a note sequence or modulate a parameter/CC. The screen can only show two rows a time. You can use the Up/Down arrows to scroll between rows.

On these 'selection boxes', a value of 0 means an empty row, a value of 1 is a note row, while values greater than 2 are parameters/CCs.

To add a row, just scroll down, select the empty box and use the screen controls to choose the type of row.

Please refer to the Midi Implementation Chart at the end of the document for the full list of internal parameters which can be modulated by the Sequencer: you will notice that it can control almost any parameter available in the 002R, considerably expanding the synth modulation possibilities.

Besides notes and parameters/CCs, there are 3 special (fixed) rows, to allow further control on each step:

- Gate Length, expressed in percentage of related Step Length;
- Velocity, between 0-127 (active just on note rows);
- Step Length, expressed in beat divisions.

By default, the Sequencer page shows the Step Length row in the first position for quick pattern editing. Velocity and Gate Length rows are located just above it, while notes and parameters can be added below.

- **Destination:** on the right of 'selection boxes', you can find 'destination boxes'. Notes and parameters can either be routed to the internal sound engine (Int), or sent as MIDI Note/CC messages externally (Ext), or Both, making the 002R a very flexible 'master instrument' in your studio setup.

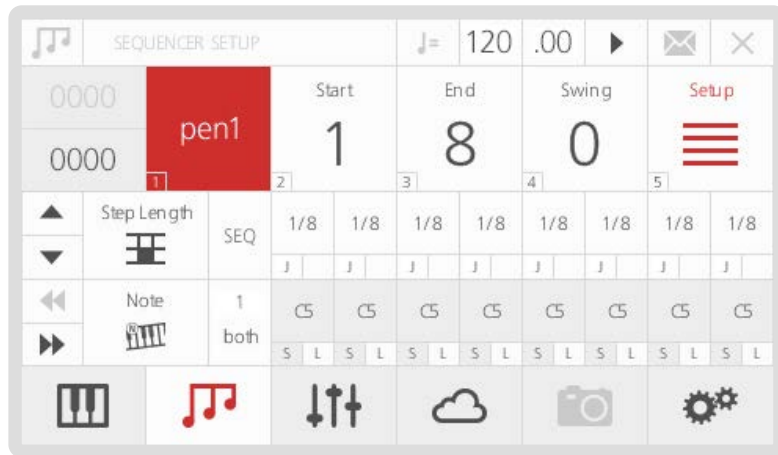

Values: Each row contains a set of 8 steps and each step has its largest part showing its current value (e.g. note number, CC value, step length, velocity and gate length). These values can be edited by turning the front panel push-dials and/or by using screen controls.

By default, the Sequencer page shows the first 8 steps (i.e. 1-8): if you want to reach and control the following steps, you can just press the Backward/Forward arrows.

Steps: each step has an inner little box on its bottom-left corner with a letter 'S' on note/CC rows or 'J' on the step length row. This option allows you to edit secondary values:

- on the note/CC rows, it controls the step Status (which creates a rest if turned OFF)
- on the step length row, it controls the Jump value (which causes the step to be ignored if turned ON, directly jumping to the next step)

Legato: on note/parameter rows, each step has an inner little box on its bottom-right corner with a letter 'L', which stands for 'legato'.

On a note row if Legato is on, the Note Off message of the selected step will be triggered after the Note On of the following step.

On a CC row if Legato is on, the parameter will slew to the next step value allowing you to create a smooth transition between steps. (Not available for Digital IO board parameters)

The Setup sub-menu page contains the following options:

1. **Mode:** allows you to set the direction mode of the sequence. You can use either the dedicated button or the screen controls to change the value of this parameter.
The available Mode options are similar to those of the arpeggiator (see end of this chapter)
2. **Start:** the start step of the sequence
3. **End:** the end step of the sequence
4. **Swing:** allows you apply swing to the sequence. A positive value delays the even step, however a negative value brings the even step forward in time

To exit the Setup page, select the Setup button again, or just type '5' (or also '0') with the keypad, provided that nothing is selected.

To Save a sequence, just press the 4th 'menu button' (D). If you were already in the Sequencer page, it automatically recognises that you are going to save a sequence (instead of a patch) - from now on, the procedure is identical to Patch Storage (see chapter 1).

Please note that patches and sequences are totally independent of each other. This means that when you save/load a new patch, 002R will not save/load a sequence together with it: to do that, you need to save both in a Performance (see 'Performance Storage' section, chapter 6).

The Animator is basically another Sequencer for parameters, but it's triggered by notes: if enabled, each note starts its own animation when pressed and all the animations run independent of each other.

Also, exactly as in the normal Sequencer, you can have 12 rows running simultaneously and they can control almost any parameter available in the 002R.

This makes the Animator a very powerful and flexible 'polyphonic' modulation source.

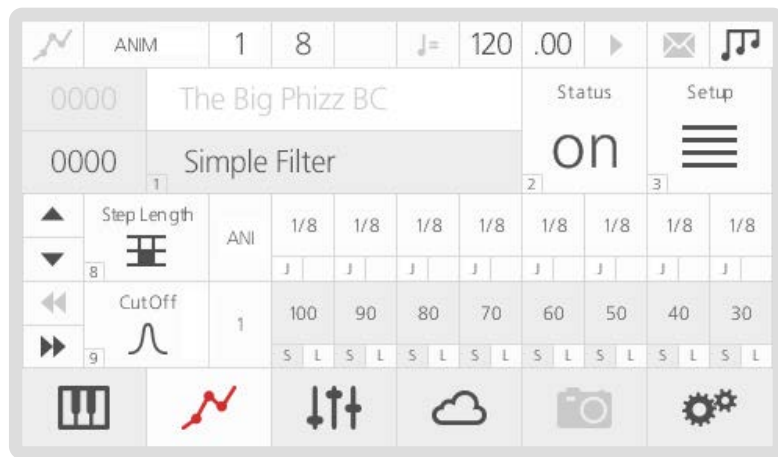

The main Animator page is very similar to the related Sequencer page, with the only differences being:

- there are no Gate Length and Velocity rows (as you would expect);
- being a modulation source for parameters only, you can't add a note row.

Legato: on parameter rows, each step has an inner little box on its bottom-right corner with a letter 'L', which stands for 'legato'. If Legato is on, the parameter will slew to the next step value allowing you to create a smooth transition between steps. (Not available for Digital IO board parameters)

Please, refer to the Sequencer section (see above) for a detailed description of all the parameters. For modulatable parameters that are not per-voice (LFO1 parameters, Spread and Digital IO board FX, mix and return parameters) only the newest note's animation will modulate it.

Also the Setup sub-menu page looks similar to Sequencer's one with the addition of a Relative/Absolute mode and Animator Cycle Mode

If 'relative' mode is enabled, the Animator will take 'relative' control of the assigned parameters by default. This means that the current parameters value is offset by the current step value. In 'absolute' mode the current step value will override the current parameters value.

Animator Cycle Mode controls if the animation loops or only plays once when triggered. There are three options:

1. **Loop** - when the animation ends it will loop back to the beginning.
2. **Single+Reset** - when the animation ends the animated parameters are set to the patch values.
3. **Single+Hold** - when the animation ends the animated parameters are set to the animations last step values

Once enabled, the Animator will take 'relative' control of the assigned parameters by default. This means that the current parameters value is offset by the current step value. In 'absolute' mode the current step value will override the current parameters value.

It is important to understand that (unlike sequences) animations are linked to patches. The Animator is intended as a real modulation source 'built into' the patch, so its settings (including Status) are automatically recalled every time you load a new patch (exactly as e.g. LFOs or Velocity modulations).

Please note that when you save a patch you save only the link to the animation's slot, not the animation itself (this because you may want to save the edited animation to a different slot, as the same animation can be used by different patches).

As in the Sequencer, as soon as you load a new Animation, the Status automatically turns on.

Please note that both the Sequencer and the Arpeggiator 'trigger' the Animator: this means that each repeated step will be 'animated' (provided that you have long enough Step Length and Gate Length values).

This can lead to very complex modulations, good to design nice evolving pads and highly textured ambient sounds.

The Modal 002R also comes with a comprehensive arpeggiator.

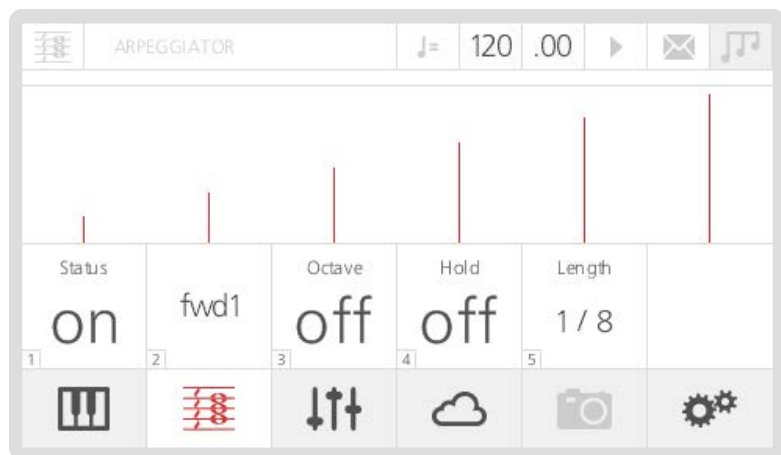

- Status:** this parameter activates the arpeggiator.
- Mode:** allows you to set the direction mode of the sequence. The available options are similar to those of the Sequencer (see Arpeggiator modes).
- Octave:** if this option is on, the arpeggiator will always repeat each note twice with the second note one octave higher, e.g. if playing C3-E3-G3-B3 in 'Forward' mode (see later), you will have C3-C4-E3-E4-G3-G4-B3-B4-C3-C4-E3...
- Hold:** if this option is off, you need to hold the keys down to include notes into the arpeggiated sequence (i.e. if you are playing a chord and you leave just one key, the arpeggiator removes that from the sequence, but will keep playing the remaining notes).
Alternatively, if this option is on, you can insert new notes in the sequence without holding the keys down and then remove them by pressing the same keys again. This is a unique feature of the 002R, and allows you to easily access other parameters of the synth while the arpeggiator is running, as well as have more control over the pattern of notes, similar to a full sequencer.
- Length:** this parameter controls the step length of the arpeggiator, expressed in beat-divisions. This means that the length of each repeated note will be calculated accordingly to the current 'Tempo' value (expressed in BPM).

At the moment, the 'Gate' of the arpeggiator is set at a default value of 50% (i.e. the release phase of the envelopes actually starts at half of the step length value).

In this section we are going to explain the different modes available for the Sequencer, the Animator and the Arpeggiator.

From now on, 'pressed-order' means the order in which you played the notes; on the other hand, 'note-order' means the keyboard ascending/descending order, no matter which notes you pressed first (i.e. this is the standard meaning of 'order' for classic arpeggiators).

Modes 'fwd1', 'bck1', 'pen1', 'pen2', 'shuf' and 'rand' are available for both the Sequencer, the Animator and the Arpeggiator. Modes 'fwd2', 'bck2', 'pen3' and 'pen4' are available for the Arpeggiator only.

As an example, let's take a sequence of notes in this order G-C-B-E:

- **Forward1 ('fwd1'):** the arpeggiator repeats the notes in the same pressed-order
i.e. G-C-B-E-G-C-B-E-G...
- **Backward1 ('bck1'):** the arpeggiator repeats the notes in inverse pressed-order
i.e. E-B-C-G-E-B-C-G-E...
- **Pendulum1 ('pen1'):** the arpeggiator repeats the sequence forward then backward, playing the first and last notes twice
i.e. G-C-B-E-E-B-C-G-G-C-B...
- **Pendulum2 ('pen2'):** like Pen1, but without repeating the first and last note of the sequence
i.e. G-C-B-E-B-C-G-C-B-E-B...
- **Shuffle ('shuf'):** the arpeggiator generates a random pattern (i.e. a new note order) as long as the number of pressed notes, then it repeats that pattern
i.e. B-E-G-C-B-E-G-C-B-E...
- **Random ('rand'):** completely random pattern
- **Forward2 ('fwd2'):** like Forw1, but in note-order
i.e. C-E-G-B-C-E-G-B...
- **Backward2 ('bck2'):** like Back1, but in note-order
i.e. B-G-E-C-B-G-E-C-B...
- **Pendulum3 ('pen2'):** like Pen1, but in note-order
i.e. C-E-G-B-B-G-E-C-C-E...
- **Pendulum4 ('pen4'):** like Pen2, but in note-order
i.e. C-E-G-B-G-E-C-E-G...

06

Multi-Timbrality

Performance mode

Modal 002R features full multi-timbrality: in 'Patch Mode', (i.e. the mode we have discussed so far) you can load 1 single sound preset and use all the 8 or 12 voices available for it; eg on a 12 voice Modal 002R in 'Performance Mode' you can load up to 12 sound presets (called 'parts' from now on) simultaneously.

For each part you have several options, including how many voices you can allocate, active keyboard range, etc.

If you are in the standard patch loading page, press the first 'menu button' (A) and the screen will show a confirmation page: if you press 'Yes' (first 'menu button' again), the synth will switch to Performance Mode after a momentary wait message; if you press 'No' (second 'menu button') you will stay in Patch Mode.

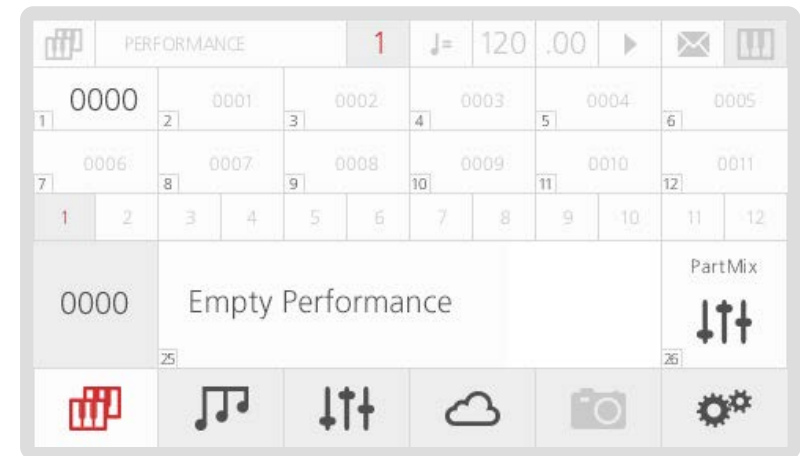

When in Performance Mode, the top bar of the screen displays the Part Number: this number, highlighted in red inside a grey box, shows which part is currently loaded and it will stay there on every page until you select another part.

On a 12 voice 002R, to select a part and edit it in the related Part page (see next section), you can use the 12 central boxes with patch numbers written in it. Right below this, you can also use the 12 smaller boxes to quickly switch on and off each parts. It is the same on an 8 voice 002R, except there are only 8 boxes.

Along the bottom of this main Performance page, you will find:

- **Performance Number/Name:** these two boxes show the current performance slot number and name (see end of the chapter for a detailed explanation), which can be used to load performances in the same way that patches are loaded.
- **PartMix:** this button gives you access to a volume mixer for the parts. Each part has a Gain parameter, which is a coefficient of the VCA-Amount (see Envelopes section in chapter 3): its values go from 0 (silence) to 127 (full VCA-Amount).

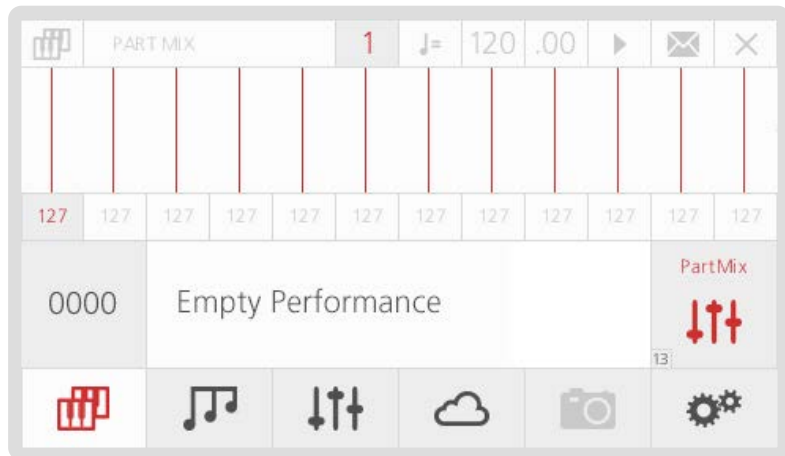

To exit Performance Mode and go back to Patch Mode, just press the first 'menu button' (A) again.

Once you select a part for editing the LCD will show a 'Part Page' where you can find:



1. **Patch Name/Number:** these two boxes show slot number and name of the the patch which is currently used by the selected part. The Name box can be used to load patches in the same way that regular patches are loaded (see chapter 1).
When you want to exit from this control, press the first 'menu button' (A) underneath the LCD.
2. **Status:** this switch turns the status of the current part on or off.
3. **Keyrange controls (lower-upper):** these two controls allow you to select the set of keys on the keyboard that can play this part in order to create keyboard splits. One control is on the left for setting the lowest key and one control on the right for setting the highest key. By default the whole keyboard is selected.
4. **Voices:** this parameter selects the number of voices allocated to this part.
5. **Destination:** this sets where notes and parameter/CC messages are being sent, i.e. the internal sound engine only (Int), external MIDI Out only (Ext), or Both.
6. **MIDI Channel:** this parameter sets what channel MIDI messages from this part are sent out on, as well as the channel of messages that this part will process from the MIDI input. This parameter also defines the interaction between the selected part and the 002R's joystick and keyboard, according to the settings in the Performance Mode's Global menu.
IMPORTANT: please note that joystick and keyboard will be active in the selected part if and only if they share the same MIDI Channel.
7. **Transpose:** this parameter sets the keyboard note transpose value for this part.
8. **Gain:** this parameter sets the gain of the current part (same as in PartMixer - see above).
9. **Spare:** this box displays the number of free/unallocated voices

When you save a patch in Patch Mode, you store all the synth engine parameters, together with Arpeggiator settings and a link to an Animation (if any used) and Sequencer (if link is on). See Patch Storage section in chapter 1 for further details on how to save a patch.

Same thing applies if you store a patch while you are editing a part (not a performance) in Performance Mode.

However, if you are in the main Performance page and you press the 4th 'menu button' (D), it will automatically detect that you are working on an entire Performance and proceed with saving it (as shown in the picture below).

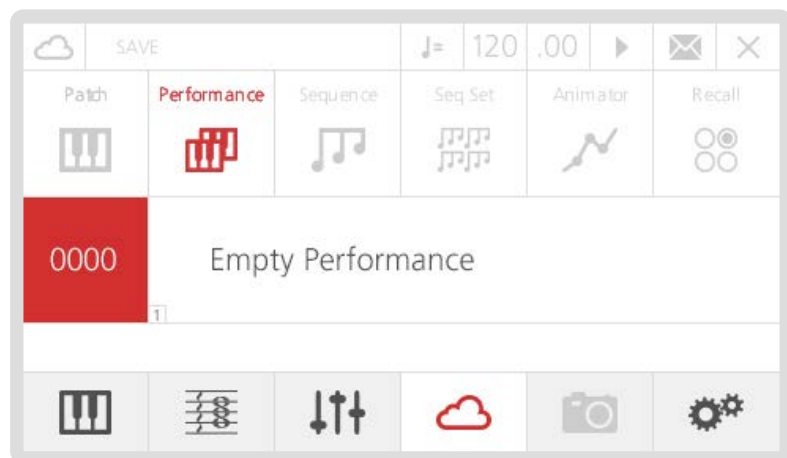

With the word Performance we mean several things together:

- a link to a patch for each part, so up to 12 different patches together
- all the settings for each part (channel, keyboard ranges, etc.)
- a link to the sequence used on each part and its status
- PartMixer and Channel settings.

07

Snapshot

Snapshot

Snapshot is a feature that allows you to compare your edited sound with the sound that is saved in the currently loaded patch.

When a sound has been edited an asterisk (*) will appear at the beginning of the name to let you know that there are unsaved changes. At this point you can press the snapshot button (menu button 'E') to hear the original sound and the asterisk will disappear. Pressing this button again will take you back to your edited sound.



When Snapshot is enabled or disabled the user is kept on the current page. A useful example of this functionality is when a user has changed some filter settings on the VCF page but wants to know what the original filter settings were. Pressing the snapshot button will show the saved settings, then pressing again will show the current settings.

Please note any changes made when Snapshot is enabled are discarded when Snapshot is disabled, so re-enabling will go back to the original sound that was loaded, not the sound before disabling Snapshot mode.

Pressing and holding menu button 'E' will reload the original sound and discard any changes you may have made.

08

Digital Input/Output Board



Digital Input/Output Board

The Modal 002R Digital I/O Card provides the Modal 002R synthesiser with digital audio and MIDI input and output capability over Class Compliant* USB, plus the ability to apply a range of audio effects to the sound presets.

More specifically, the Digital Card allows up to twelve channels (one per voice) of audio to be sent to a DAW over a single USB connection at either 48 or 96KHz / 24 bits, as well as 'master' stereo pairs (either with or without effects) over USB at up to 192KHz / 24 bits.

Additionally, it provides a stereo input from a DAW, pre-filter stage on the 002R, allowing external audio to be processed by the 002R analogue VCF and VCA (again at either 48, 96 or 192KHz / 24 bits)

The I/O Card also features three discrete effects buses, with Chorus, Delay and Reverb channels, which can be configured and controlled to create custom effects presets and easily be applied to single timbre patches or multi-timbral performance setups.

USB MIDI works in the same way as the existing MIDI IO of the synth: it works with notes, CCs, pitchbend, program change messages, aftertouch, clock timing/start/stop, and all the existing controls/settings (e.g. MIDI filters) work with USB MIDI as well.

*(class compliant on Apple Macintosh™ computers, may require a driver for some Windows™ PCs)



Digital Input/Output Board Diagram

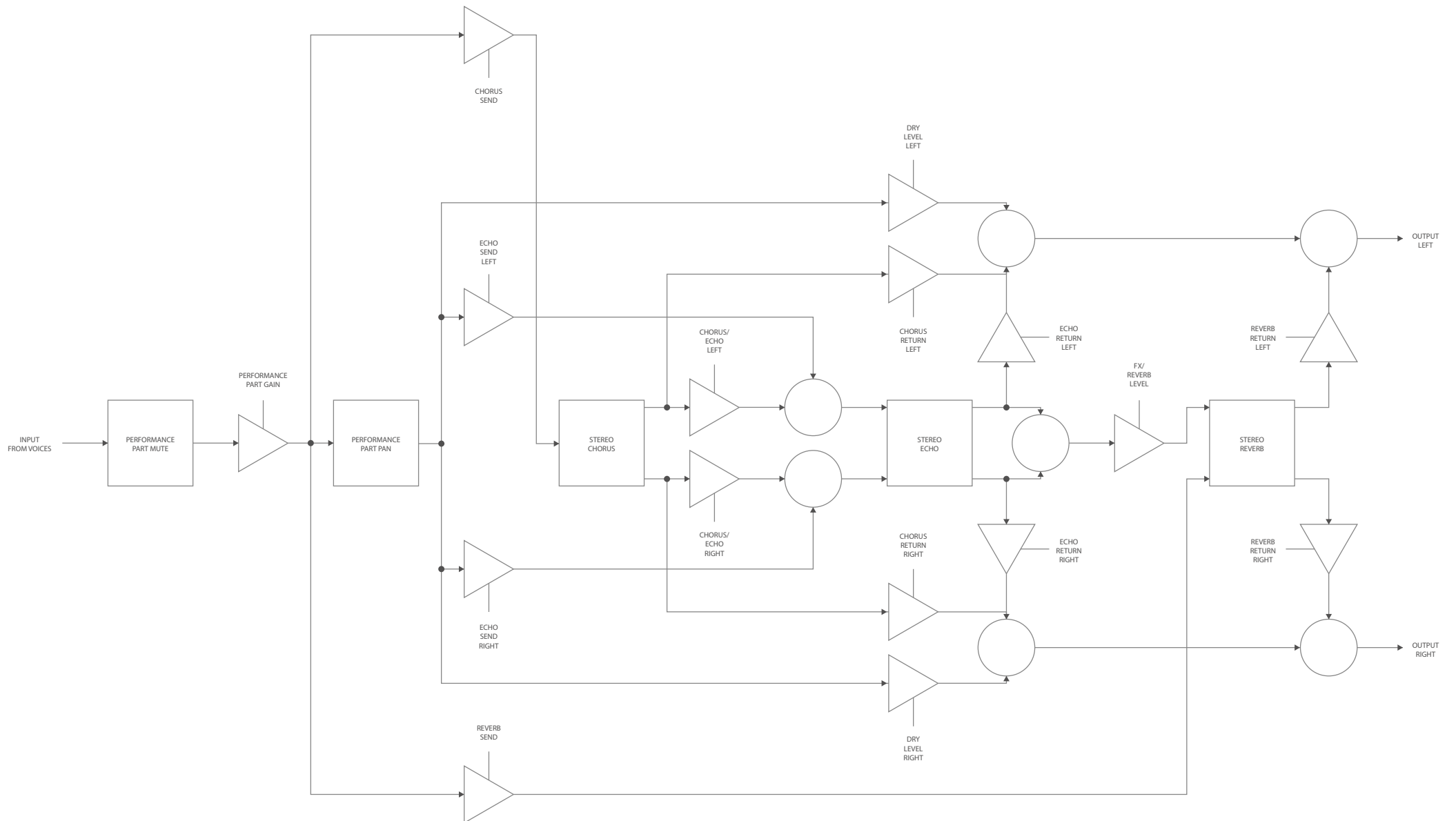



Modal Digital I/O Card is USB class compliant* on Apple Macintosh™ computers and as such it doesn't require any installation process: please plug a USB cable from the 002R's 'USB Audio/MIDI' port to an available USB port on your computer and the Digital Card will be ready to use.

In your DAW preferences please select the default CoreAudio driver option, then select the Input/Output Device related to the Digital Card: this should be in the form of 'MODAL DOB L2 x', where 'x' stands for either '48', '96' or '192', according to the value of the 'USB Audio Out Mode' setting on your 002R synthesiser (more details in the next section).

On Mac OSX you can also create an aggregate device in the Audio MIDI Setup page: this allows you to merge the available audio channels on your 002R Digital Card with the ones on your main studio audio interface into a unique audio device. In this case, please make sure that the aggregate device (not the 'MODAL DOB') is selected as Input/Output Device in your DAW preferences.

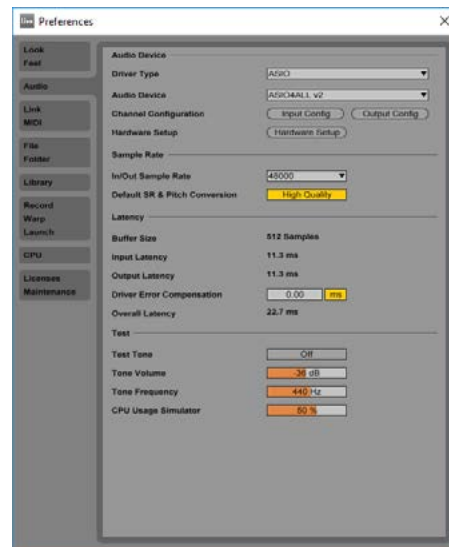
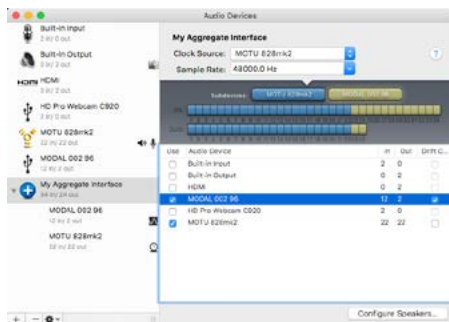
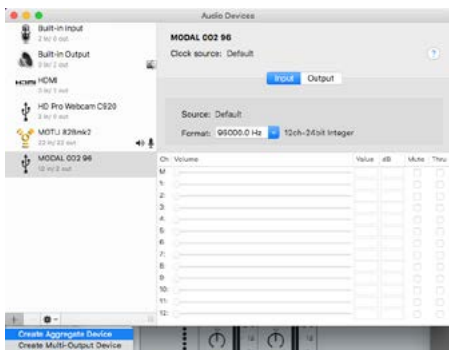

If using the Digital I/O Card for USB audio on a Windows system, Modal recommends using the ASIO4ALL universal ASIO driver. Please download and install ASIO4ALL from <http://www.asio4all.com>, then plug the USB cable coming from your 002R's 'USB Audio/MIDI' port.

In your DAW preferences please select the Driver Type (where applicable) to 'ASIO' and the Audio Device to 'ASIO4ALL' (to the left is a screenshot of the Ableton Live audio preferences).

Now please open the ASIO4ALL setup window either via the up-arrow icon on the right side of Windows bottom bar, or with a dedicated button which can usually be found on most DAWs (in Ableton Live this is called 'Hardware Setup' - see above screenshot).

Please configure the ASIO4ALL settings to setup the input/output devices you want to use within your DAW. For example, to use your 002R Digital Card as an audio input device (while still using your main audio interface as output device), please enable the MODAL 002 'In' channels (but not the 'Out' channels) in the ASIO4ALL settings.

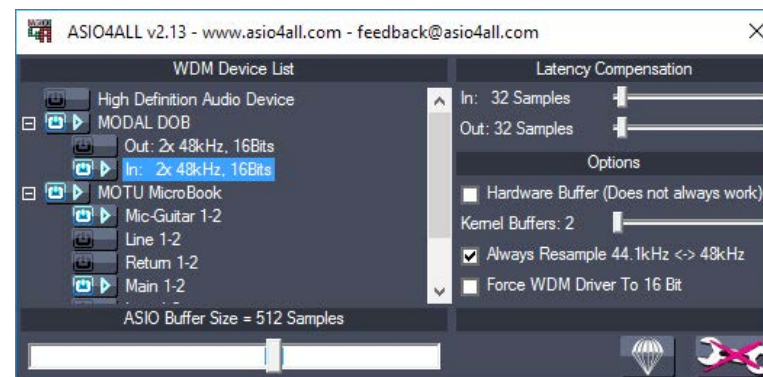

***IMPORTANT NOTE FOR WINDOWS USER:** if using a Windows operating system the 'USB Sample Rate' on your 002R Settings must be set to '48Legacy'. Other sample rates will not work with Windows OS, resulting in no audio device appearing.

The Modal Digital I/O Card features a digital effects section, which contains three fully controllable FX: Chorus/Flanger, Stereo Echo/Delay, Reverb.

There are 1000 FX presets, and each preset is a combination of the three effects.

The FX main page is accessible either as last option in the Parameters Menu (third button below the LCD) or, more simply, by clicking the 'Assign' button on the right hand side of the front panel.

In addition to this, the three encoders of the 'Assign' section can be used to control the three Digital Card FX Return values (see below).

You can press and hold the 'Assign' button to switch between 'Alternative Page Controls Mode' ('A' LED lit up) and 'FX Controls Mode' ('B' LED lit up).

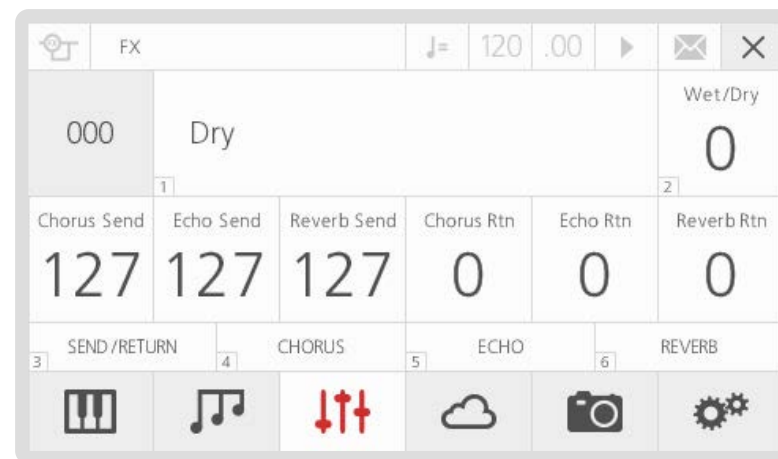

1. **Preset Name / Number:** in Patch mode, each Patch has a linked FX preset, which is automatically recalled everytime you load that Patch. You can change the linked FX preset by loading a different one then saving the Patch. An FX preset contains all the individual FX settings as well as three Return controls, but not Sends and Dry/Wet (see below)
2. **Dry/Wet:** each Patch has standard FX Dry/Wet parameter (0 = fully dry, 64 = equal mix, 127 = fully wet) which controls the global effects mix for the Patch. Please note that this is a Patch parameter (as opposed to FX parameter)
3. **Sends:** each Patch has three Send parameters which control how much of the Patch sound is sent to the three effects. Please note that these are Patch parameters (as opposed to FX parameters)
4. **Returns:** each FX preset has three Return parameters which control the output level of each effect line.

Within a certain degree of approximation, the Return controls can be considered as the amount / level of each effect applied to the original sound: for this reason, they are particularly important and they can be easily controlled from the front panel thanks to the three encoders of the 'Assign' section - provided that the 'Assign' button LED is in 'B' mode (press and hold the button to switch mode).

Please note that these are FX parameters (as opposed to Patch parameters), so their values are stored within the FX preset.



There are some differences in the routing of the FX section between Patch and Performance mode.

In Performance mode, the linked FX preset number, as well as the Dry/Wet amount, are 'global' Performance parameters, so they are stored together with the overall Performance (not the single Part).

On the other hand, the three Send controls are Part parameters: they are particularly useful for applying different levels of the overall FX to each Part in the Performance.

The three Return controls are again part of the linked FX Preset, not Part / Performance parameters.

Additionally, the Digital I/O Card allows to panpot each voice (thus each Part) individually: you can find a 'Pan' parameter in the Part Mixer section along with a Mute parameter, accessible via the main Performance mode page.

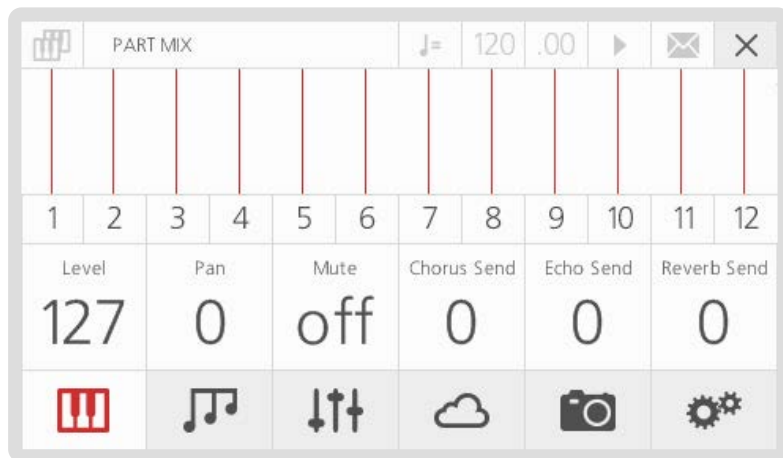

CHORUS

- Delay: delay time of the Chorus effect
- Feedback: amount of feedback
- Mod Time: rate of the LFO which modulates the Chorus Delay Time
- Mod Depth: amount of modulation of the LFO applied to the Chorus Delay Time
- Width: Chorus stereo width

ECHO (DELAY)

- Cross Level: amount of left input sent to the right delay line and viceversa
- Left Time: delay time on the left channel. Values 0-127 are free-running time values, whereas values in the negative range are beat division values for syncing the time to the currently selected MIDI clock
- Left Feedback: amount of feedback on the left channel, which determines the total length of the echo on the left
- Right Time: delay time on the right channel. Values same as Left Time.
- Right Feedback: amount of feedback on the right channel, which determines the total length of the echo on the right
- Chorus/Echo: amount of signal processed by the Chorus which is fed into the Echo

REVERB

- Pre-Delay: initial delay time before the signal is sent to the reverb
- Time: time required for the reverb tail to drop to -60dB (also known as T60)
- Delay: relative length of the internal reverb delay buffers: low to middle values change the resonance frequencies of the room, while high values give an unnatural sucking effect to the buildup. The effect is most noticeable when using shorter Time.
- Late Refl: early reflections vs. late reflections balance, i.e. low values emphasise the early reflection stage, while high values emphasise the 'diffusion network' (i.e. main reverb body and tail)
- Feedback: internal feedback coefficients levels: very low or very high values cause self-oscillation of the reverb
- FX/Reverb: amount of signal processed by the Echo, which is fed into the Reverb

09

Settings

Settings

In this section we are going to have a look at the settings page of the Modal 002R. You can access this page by pressing the sixth 'menu button' (F).

You can access the six available sub-menus by pressing the corresponding number on the keypad (or using the '-/+Select' buttons).

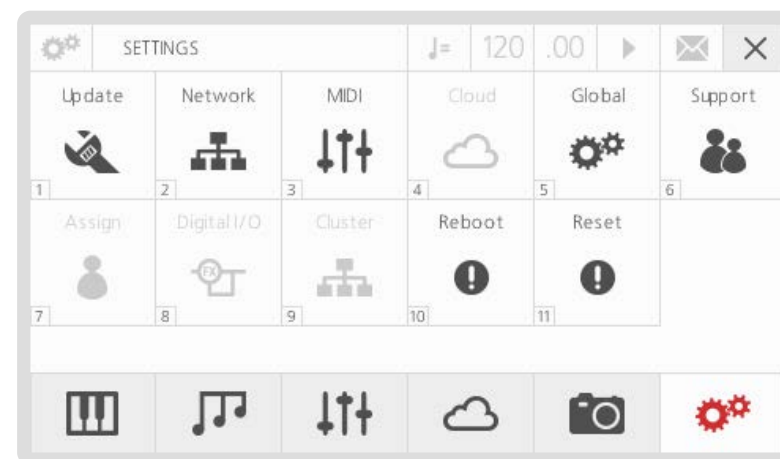

The update procedure of the Modal 002R operating system is very easy. To enter the Update section from the settings page, just press number '1' on the keypad: the main area in the centre of the screen will show the current OS version.

Update: If you want to update your system, just press number '1' again: the Modal 002R will now check for available updates.

If there is no new software available, the screen will go back to the patch loading page. If there is a new version of the software, it will ask if you want to download it from our servers and update the system.

Please note that the update procedure may take from 3 to 10 minutes (depending on the size of the update): during this time, the screen will display a progress bar and the current step of the update.

- DO NOT TURN THE SYNTH OFF NOW! - You may cause serious damage to the internal structure of the OS and lose your data.

After a successful update, the synth will automatically reboot and get back to the previously selected preset.

Redo: if for any reason (see Troubleshooting section) you need to re-install the latest software OS, press number '2' on the keypad. The 002R will now run the update procedure again and install the same software version.

Quick Redo: A quicker version of the above 'Redo' option, where it only reinstalls the elements of the OS that have changed.

Before turning the Modal 002R on, be sure to connect it to your local router via ethernet cable: as soon as you turn the synth on, the OS will automatically establish an internet connection. If everything goes fine, you should be able to go to the settings page, press number '2' on the keypad to access the Network screen, and see this:



The IP Mode area displays 'DHCP' and your 002R should have an automatically assigned IP Address: a valid local IP address has the 192.168.0.x format.

1. **Out Channel:** this parameter controls the number of the global MIDI Out channel (1-16) in Patch Mode.
2. **Local:** this option is disabled on 002R as there is no keyboard
3. **Clock:** Internal, external or auto MIDI clock. If using internal MIDI clock, the Sequencer, Arpeggiator and MIDI-synced LFOs will be synced to the Tempo parameter (expressed in BPM - always displayed in the top-right corner of the screen). When using external, the 002R's clock will be synced to the MIDI clock coming from an external source. Selecting the third 'auto' option will set the 002R to sync to an external clock if MIDI clock messages are detected, else it will sync to the internal clock."
4. **MPE Mode:** Turn this on to enable the synth to correctly respond to MPE messages. See the MPE section for more information on this.
5. **In Channel:** this parameter controls the number of the global MIDI In channel (1-16) in Patch Mode. This parameter is currently ignored in Performance Mode, where the MIDI settings are defined by the Channels sub-menu and each part's internal settings (see 'Performance Mode' section in chapter 6). Only visible when 'MPE mode' is off.
6. **MPE Master:** Sets the MPE Master/Global channel when MPE Mode is on. Set this to match that of your MPE instrument, where channel 1 is used for the MPE Lower Zone, and channel 16 for the MPE Upper Zone. See the MPE section for more information on this.

The 002R can contain up to three different interfaces/ports all for providing MIDI input/output to the synth. These are as follows:

- **MIDI-DIN sockets (In, Out, Thru)** – For connecting traditional MIDI devices to the 002R via 5 pin DIN connectors.
- **USB-A port** - For connecting class compliant USB-MIDI devices to the 002R, such as USB-MIDI keyboards. Devices should be connected directly rather than through a USB hub.
- **USB-B port (digital IO board only)** – For connecting the 002R to a USB host, such as a computer, allowing the synth to appear as a USB-MIDI device.

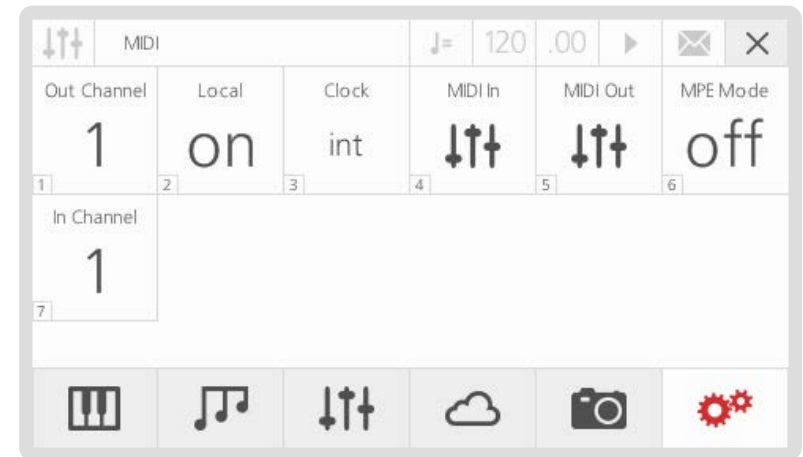

In this page you can individually enable or disable different categories of external MIDI messages received from the MIDI In port on the back of 002R.

1. **Notes:** this parameter enables / disables processing MIDI Note messages (Note On, Note Off and Velocity)
2. **Control:** this option enables / disables processing MIDI Control Change messages
3. **Patch:** this option enables / disables processing MIDI Bank and Program Change messages
4. **AfterTouch:** this option enables / disables processing MIDI Aftertouch messages
5. **PitchBend:** this option enables / disables processing MIDI Pitchbend messages
6. **Transport:** this option enables / disables processing MIDI clock start/continue/stop messages
7. **Pbend Range:** this option scales the range the internal voices interpret incoming MIDI Pitchbend messages in semitones
8. **MPE Pbend:** This option scales the range that the internal voices interpret incoming MPE per-voice Pitchbend messages, in semitones. Certain MPE instruments may require a specific range here for X-axis expression to behave as expected.
9. **CCs as Modulation:** When enabled this prevents MIDI-in CC messages from updating patch values on the LCD or Web Interface and instead just treats the CC messages as modulation control values. This improves the performance of the synth when sending many simultaneous streams of CC automation from a DAW or when using external MIDI controllers that send many streams of CC messages for modulation.

MIDI-in Activity Indicator

The crochet symbol on the top bar of the LCD will flash when receiving any MIDI-In data (except for clock messages). Please note that messages not on the global MIDI channel will also be shown here.

In this page you can individually enable or disable different categories of internal MIDI messages sent from 002R.

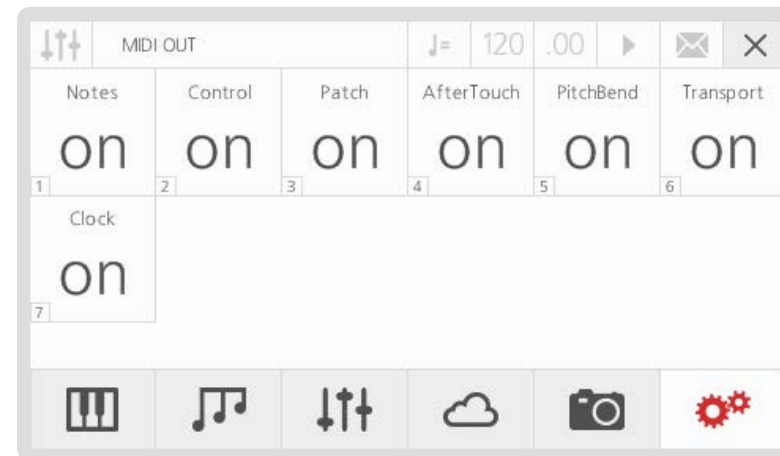

1. **Notes:** this parameter enables / disables processing MIDI Note messages (Note On, Note Off and Velocity)
2. **Control:** this option enables / disables processing MIDI Control Change messages
3. **Patch:** this option enables / disables processing MIDI Bank and Program Change messages
4. **AfterTouch:** this option enables / disables processing MIDI Aftertouch messages
5. **PitchBend:** this option enables / disables processing MIDI Pitchbend messages
6. **Transport:** this option enables / disables processing MIDI clock start/continue/stop messages
7. **Clock:** this option enables / disables processing MIDI Clock messages

To access the Global Settings page, you can press number '5' on the keypad: the screen will show you the available parameters.

1. **Tune:** Add a global tune offset for the whole synth.
2. **PageSwitch:** the Modal 002R display is context sensitive: this means that the parameter associated to any encoder touched by the user is immediately displayed. You can disable this option by turning the value of this PageSwitch option off.
3. **Brightness:** This parameter controls the LCD screen brightness.
4. **Seq Link:** This parameter sets the behaviour of linked-sequence loading whilst the sequencer is active. When 'Seq Link' is set to off it disables linked sequence loading whilst the sequencer is playing - this allows you to preview the same sequence with different patches. Else the linked sequence is loaded on every patch load, regardless of the playing state of the sequencer.
5. **AutoLoad:** This parameter enables Patches / Sequences / Animations after a short pause to be loaded without needing to press Select to confirm.
6. **OscTune:** This page allows you to adjust the tuning of each oscillator individually, for each voice. A value of +64 is 1 semitone up, -64 is 1 semitone down. Whilst you have selected an oscillator on the LCD tuning settings page, only that oscillator will play.
7. **Poly Note Priority Mode:** Sets the note/voice priority when stealing notes in poly/stack mode. The options are: 1. Last note - the oldest note is stolen giving priority to the last/newest note. 2. Lowest note - the highest note is stolen giving priority to the lowest note. 3. Highest note - the lowest note is stolen giving priority to the highest note. 4. Off - note stealing is turned off.

This feature allows you to get remote technical support from the Modal Electronics team: this means that a Modal operator can connect to your unit in order to diagnose and fix potential problems.

If you have any issues with your 002R then you can contact us at:

support@modalelectronics.com

We will get back in touch and supply you with a 10 digit access code that will allow us to access your synthesiser remotely. The code can be entered with either the keypad or using the on screen controls. When the code has been entered then navigate to and press DONE.

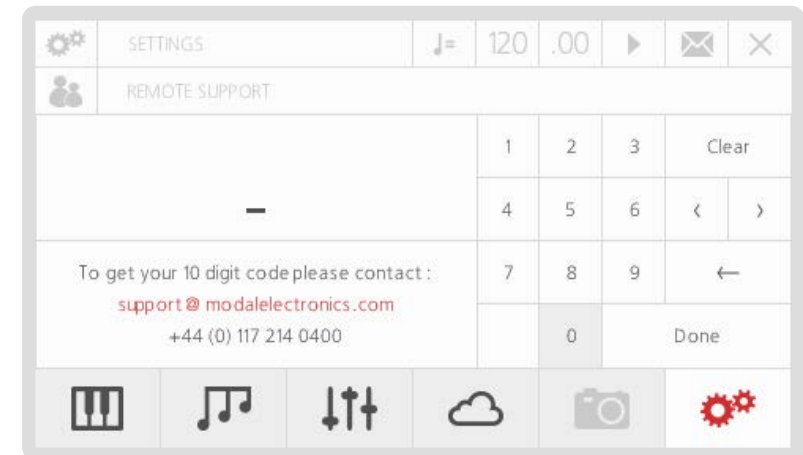

If a Modal Digital I/O Card is installed, the USB Digital Input and Output audio settings are available in the main Settings page (sixth button below the LCD screen).

These are all global preferences, so they are saved between sessions.

1. **Bypass:** if this parameter is On, the Digital Card is completely bypassed
2. **USB Audio In:** this is a Gain parameter for the USB digital stereo input channel.
This works exactly in the same way as the analogue Audio-In in the 'Mixer' page, where you have to set the 'Ext In' control to above 0 to allow the audio input to be triggered.
Please note that USB Audio-In will only work if no jacks are connected to the analogue Audio In connectors.
3. **USB Sample Rate:** it sets the audio sample rate of the digital audio stream over USB, between 4 different options from 48 to 192kHz (more details in the next section)
4. **USB Audio Out Mode:** this specifies how the host computer will see the Digital I/O Card, as either stereo pairs channels 1-2 and 3-4 ('stereo' mode) or 12 separate mono channels ('12 channel' mode) (more details in the next section)
5. **DSP Gain:** if the Auto Gain algorithm is disabled, you can manually adjust the DSP Gain. To find the optimal setting, please start from very low values, then play some notes / chords and increase the value until you can hear clipping.
6. **Auto Gain:** this enables an algorithm to prevent digital clipping. Please bear in mind that the sum of the 12 002R's analogue voices outputs can be very hot and this can cause problems in the input stage of the Digital Card's DSP: this is particularly true when using Unison patches with a large Size value, or even just Poly patches with very long releases. In order to prevent digital clipping, the Auto Gain algorithm applies a gain factor before the signal enters the DSP, based on the current patch Drive and Osc Mix settings.
7. **Legacy Output Mode:** This sets half the voices to be hard-panned to the left audio output, and the other half to be hard-panned to the right, just like on the original 002R output board



USB audio-out is available using 4 different sample rates, which each appear on the host computer as separate USB devices/drivers. These are:

- **'48Legacy'** (USB Audio Class 1, needed for Windows computers, at 48kHz), available as either wet stereo pair output or dry stereo pair output
- **'48kHz'** (USB Audio Class 2 at 48kHz), available as stereo pair output or 12 channel outputs
- **'96kHz'** (USB Audio Class 2 at 96kHz), available as stereo pair output or 12 channel outputs
- **'192kHz'** (USB Audio Class 2 at 192kHz), available as stereo pair output.

In 48/96kHz the host computer will always see 12 input channels, no matter whether the USB Audio Out Mode is set to 'stereo' or '12 channel' mode. In 192Khz mode only 4 channels are shown.

If in 'stereo' mode the wet audio will come out of channels 1-2 and the dry audio will come out of channels 3-4; if in '12 channel' mode each voice will come out of its own channel and will have no FX applied.

***IMPORTANT NOTE FOR WINDOWS USER:** if using a Windows operating system the 'USB Sample Rate' on your 002R Settings must be set to '48Legacy'. Other sample rates will not work with Windows OS, resulting in no audio device appearing.

Reboot

If you experience any odd behavior on your 002R (see Troubleshooting section), you can reboot the machine with this command: if the rest of the front panel stops responding, you should still be able to trigger the reboot by using screen controls.

If the software reboot fails, the LCD screen will say so and suggest a hardware reboot: in this case please make sure to leave the unit off for at least 60 seconds before powering it back up.

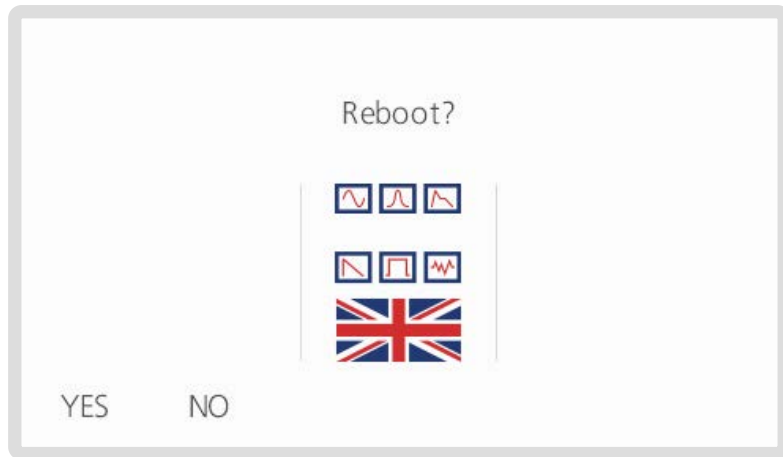

Reset

If you experience any odd behavior on your 002R (see Troubleshooting section), you can reset parts of the operating system with the 3 options in this page.

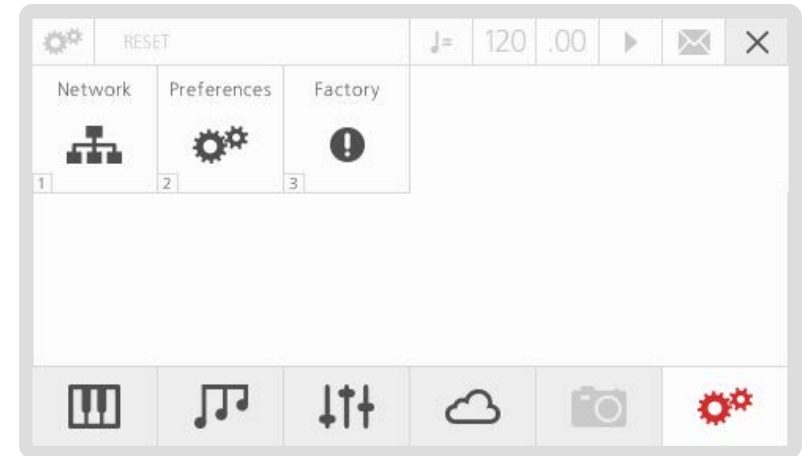

1. **Network:** this option resets all Network settings and it is very useful anytime you connect the 008 to a different router or in a different network configuration
2. **Preferences:** this option resets all the Setting preferences to the original factory values
3. **Factory:** this option triggers a complete factory reset: in detail, it resets all 002R settings, including the above Network and Preferences, as well as restoring the original factory sound banks. Please be careful when applying this, as you will lose all your saved patches that are in the factory banks.

10

Web User Interface

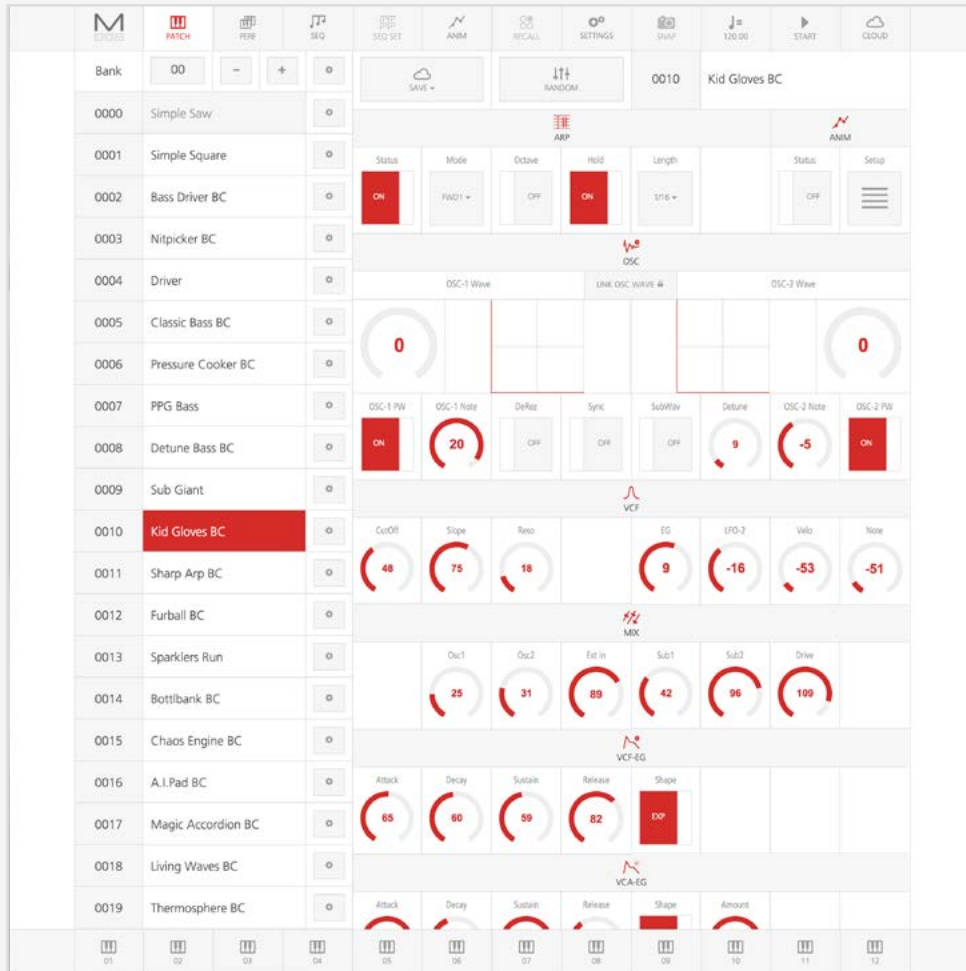

Connection

The Web User Interface is a web based editor for remotely controlling any parameter on your Modal synthesiser. Once connected to the synth you will be able to edit patches, set up sequences and perform additional actions that are not available on the front panel.

The procedure to add your synthesiser to your network and connect to the Web UI is outlined below:

1. Connect the power lead to your Modal synthesiser. On the back of the instrument you will find an Ethernet socket that can be used to connect the synth to your local network router via a standard Ethernet cable. Once the connection has been established you can power up the unit.

If you can't easily reach your router, you can use a laptop / desktop computer to share the internet connection. Please bear in mind that each operating system (MacOSX, Windows, Linux) has a different method to do this.

2. Please ensure your synthesiser is connected to your local network and powered up, then press the sixth button below the LCD to enter the Settings page.
3. Press '2' on the keypad to enter the 'Network' page and show the 'IP address' of your Modal device. It's usually of the form - 192.168.xxx.xxx but this can vary depending on network settings.
4. Now open a web browser (we recommend Google Chrome) on your computer or tablet and in the address bar at the top type in - <http://192.168.xxx.xxx>

We do not recommend using Internet Explorer. Also phone size devices are not supported.

You should now see the Web UI Patch editor screen.

Loading, Saving and Current Patch

On the left hand side of the page you can find a scrollable list of all the 100 patches contained in the currently selected bank. To load a patch, just click on its name and you will see the parameters in the main section updating.

The selected patch is now highlighted in red.

To the right of each patch slot you can find a small button with a gear icon. If you click on it, 3 options will appear: to quickly rename a patch, just click on its name with the mouse and delete/input new letters with the keyboard, then press 'Rename' to commit the changes ('Swap' and 'Init' are currently not implemented).

On the top of the list you can choose the bank number, either by incrementing/decrementing the selection with the '+/-' buttons or directly typing the bank number in the box.

Just below the navigation bar, centre page, there is a section featuring 3 main functions.

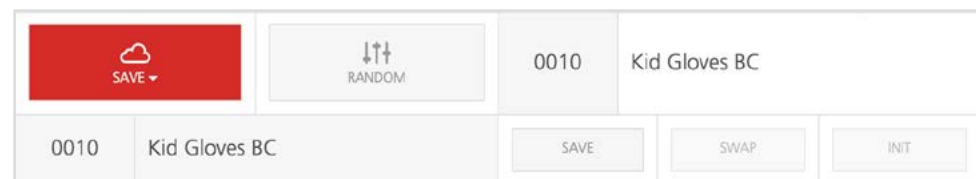

- 1. Save:** by pressing this button, you can open the Patch saving section: you can change both Patch slot number and name, just by clicking on the related boxes with the mouse and using the keyboard. To commit the edits, then please press 'Save' ('Swap' and 'Init' are currently not implemented)
- 2. Random:** if you press this button, all the parameters in the Patch Edit area below will randomly change value – this is a good alternative to load an initialised patch, as it can give you some nice unexpected sound design inputs
- 3. Current Patch:** this slot just displays the currently loaded Patch name and number, whose parameters are shown in the Patch Edit area below

The process is similar on all other pages such as the Sequencer, Animator and FX sections.

Cloud

The 'Cloud' page of the Web UI features some very useful tools, including the download of new Patch Banks, Local Patch Memory Backup and Backup Re-Upload

Click on the 'Cloud' icon on the menu at the top right to access the page: if you scroll down, you can see the four different sections.

- 1. Patch Bank Download:** to download a new bank, simply click the Download button below the related box and type in a bank number you would like the bank to go to (for example type '01').

A bank is a collection of 100 patches, e.g. bank 2 means patches from 200 to 299

- 2. Patch Backup:** enter the bank number, press 'Backup' and choose the folder on your filesystem where you want to save the sound Bank.
- 3. Patch Backup Upload:** click 'Choose File' to select the backup file from your filesystem, type in the correct bank number (make sure that number corresponds to an empty bank or a bank you want to overwrite) then confirm by pressing 'Upload'. No MIDI / SysEx dump needed.
- 4. Manuals:** download the latest full versions of the User Manual for all our products

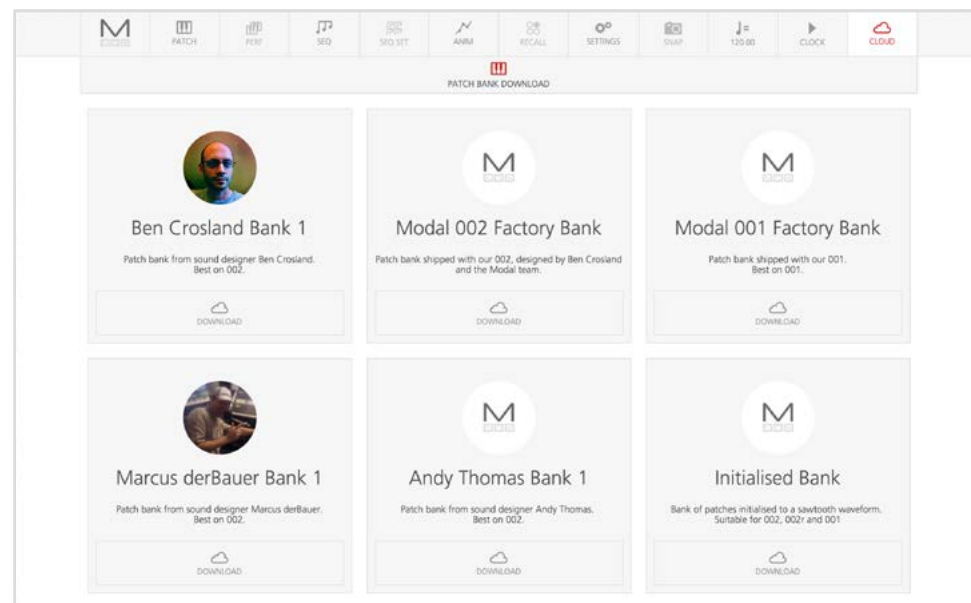

A

Appendix

MIDI CC Implementation Chart

Function	CC	Joystick Index	Sequence Index	Animator Index	Values
Mod Wheel	1	2	-	-	0 - 127
OSC1 - Wave	2	10	9	8	0 - 55 (0 - 63 in PW)
OSC1 - PW	3	-	26	25	OFF = 0 - ON = 127
OSC1 - Note	4	23	24	23	0 - 48 (-24 OFFSET)
KEYB - Glide	5	20	21	20	0 - 127
-	6	-	-	-	-
VCA - Amount	7	16	16	15	0 - 127
OSC2 - Detune	8	22	23	22	0 - 127
OSC2 - PW	9	-	27	26	OFF = 0 - ON = 127
OSC - Sync	10	-	29	28	OFF = 0 - ON = 127
OSC - SubWav	11	-	30	29	OFF = 0 - ON = 127
OSC - DeRez	12	-	28	27	OFF = 0 - ON = 127
MIX - Drive	13	25	31	30	0 - 127
MIX - Osc1	14	26	32	31	0 - 127
MIX - Sub1	15	28	33	32	0 - 127
MIX - Osc2	16	27	34	33	0 - 127
MIX - Sub2	17	29	35	34	0 - 127
MIX - Ext In	18	30	36	35	0 - 127
VCF - Resonance	19	8	7	6	0 - 127
VCF - Velo	20	-	38	37	0 - 127 (-63 OFFSET)
VCF - EG	21	12	11	10	0 - 127 (-63 OFFSET)
VCF-EG - Attack	22	13	12	11	0 - 127
VCF-EG - Decay	23	14	13	12	0 - 127
VCF-EG - Sustain	24	-	14	13	0 - 127
VCF-EG - Release	25	15	15	14	0 - 127
VCA-EG - Attack	26	17	17	16	0 - 127
VCA-EG - Decay	27	18	18	17	0 - 127



MIDI CC Implementation Chart

Function	CC	Joystick Index	Sequence Index	Animator Index	Values
VCA-EG - Sustain	28	-	19	18	0 - 127
VCA-EG - Release	29	19	20	19	0 - 127
OSC2 - Note	30	24	25	24	0 - 48 (-24 OFFSET)
VCF - Note	31	-	39	38	0 - 127 (-63 OFFSET)
-	32	-	-	-	-
VELO - Depth	33	-	61	60	0 - 127 (-63 OFFSET)
NOTE - Depth	34	-	70	69	0 - 127 (-63 OFFSET)
MODW - Depth	35	-	79	78	0 - 127 (-63 OFFSET)
LFO1 - Rate	36	5	4	3	0 - 127
LFO1 - Depth	37	4	3	2	0 - 127 (-63 OFFSET)
-	38	-	-	-	-
LFO1 - Osc1	39	-	45	44	OFF = 0 - ON = 127
LFO1 - Osc2	40	-	46	45	OFF = 0 - ON = 127
LFO1 - Wave 1	41	-	47	46	OFF = 0 - ON = 127
LFO1 - Wave 2	42	-	48	47	OFF = 0 - ON = 127
LFO1 - Slope	43	-	49	48	OFF = 0 - ON = 127
LFO1 - CutOff	44	-	50	51	OFF = 0 - ON = 127
LFO1 - Drive	45	-	51	50	OFF = 0 - ON = 127
LFO1 - VCA	46	-	52	51	OFF = 0 - ON = 127
LFO2 - Rate	47	7	6	5	0 - 127
LFO2 - Depth	48	6	5	4	0 - 127 (-63 OFFSET)
LFO2 - Note	49	-	43	42	13 - 113 (-63 OFFSET)
LFO2 - Wave	50	-	41	40	0 - 3
LFO2 - Osc1	51	-	53	52	OFF = 0 - ON = 127
LFO2 - Osc2	52	-	54	53	OFF = 0 - ON = 127
LFO2 - Wave 1	53	-	55	54	OFF = 0 - ON = 127
LFO2 - Wave 2	54	-	56	55	OFF = 0 - ON = 127

Function	CC	Joystick Index	Sequence Index	Animator Index	Values
LFO2 - Slope	55	-	57	56	OFF = 0 - ON = 127
LFO2 - Resonance	56	-	58	57	OFF = 0 - ON = 127
LFO2 - Drive	57	-	59	58	OFF = 0 - ON = 127
LFO2 - VCA	58	-	60	59	OFF = 0 - ON = 127
LFO2 - Sngl	59	-	44	43	OFF = 0 - ON = 127
VELO - Osc1	60	-	62	61	OFF = 0 - ON = 127
VELO - Osc2	61	-	63	62	OFF = 0 - ON = 127
VELO - Wave 1	62	-	64	63	OFF = 0 - ON = 127
VELO - Wave 2	63	-	65	64	OFF = 0 - ON = 127
Sustain	64	-	-	-	OFF = 0 - ON = 127
VELO - Resonance	65	-	67	66	OFF = 0 - ON = 127
VELO - Drive	66	-	68	67	OFF = 0 - ON = 127
VELO - VCA	67	-	69	68	OFF = 0 - ON = 127
NOTE - Osc1	68	-	71	70	OFF = 0 - ON = 127
NOTE - Osc2	69	-	72	71	OFF = 0 - ON = 127
NOTE - Wave 1	70	-	73	72	OFF = 0 - ON = 127
JOY - X+ Depth	71	-	-	-	3 - 123 (-63 OFFSET)
NOTE - Wave 2	72	-	74	73	OFF = 0 - ON = 127
NOTE - Slope	73	-	75	74	OFF = 0 - ON = 127
VCF - CutOff	74	3	2	1	0 - 127
NOTE - Resonance	75	-	76	75	OFF = 0 - ON = 127
NOTE - Drive	76	-	77	76	OFF = 0 - ON = 127
NOTE - VCA	77	-	78	76	OFF = 0 - ON = 127
MODW - Osc1	78	-	80	79	OFF = 0 - ON = 127
MODW - Osc2	79	-	81	80	OFF = 0 - ON = 127
MODW - Wave 1	80	-	82	81	OFF = 0 - ON = 127
MODW - Wave 2	81	-	83	82	OFF = 0 - ON = 127



MIDI CC Implementation Chart

Function	CC	Joystick Index	Sequence Index	Animator Index	Values
MODW - Slope	82	-	84	83	OFF = 0 - ON = 127
MODW - CutOff	83	-	85	84	OFF = 0 - ON = 127
MODW - Drive	84	-	86	85	OFF = 0 - ON = 127
MODW - VCA	85	-	87	86	OFF = 0 - ON = 127
AFTT - Osc1	86	-	89	88	OFF = 0 - ON = 127
AFTT - Osc2	87	-	90	89	OFF = 0 - ON = 127
AFTT - Wave 1	88	-	91	90	OFF = 0 - ON = 127
AFTT - Wave 2	89	-	92	91	OFF = 0 - ON = 127
AFTT - Slope	90	-	93	92	OFF = 0 - ON = 127
AFTT - CutOff	91	-	94	93	OFF = 0 - ON = 127
AFTT - Drive	92	-	95	94	OFF = 0 - ON = 127
AFTT - VCA	93	-	96	95	OFF = 0 - ON = 127
VCF - Slope	94	9	8	7	0 - 127
ARP - Mode	95	-	-	-	0 - 11
ARP - Note Length	96	33	-	-	0 - 96
-	97	-	-	-	-
-	98	-	-	-	-
-	99	-	-	-	-
KEYB - Mode	100	-	-	-	0 - 3
KEYB - Size	101	-	-	-	0 - 12
ANIM - Status	102	-	-	-	0 - 1
OSC2 - Wave	103	11	10	9	0 - 55 (0 - 63 in PW)
LFO1 - Wave	104	-	40	39	0 - 3
VELO - Slope	105	-	66	65	OFF = 0 - ON = 127
KEYB - Transpose	106	-	-	-	24 - 84 (-48 OFFSET)
LFO2 - Delay	107	31	42	41	0 - 127
VCA-EG - Shape	108	-	-	-	0 = LINEAR - 1 = EXPO

Function	CC	Joystick Index	Sequence Index	Animator Index	Values
VCF-EG - Shape	109	-	-	-	0 = LINEAR - 1 = EXPO
JOY - Y+ Depth	110	-	-	-	3 - 123 (-63 OFFSET)
JOY - X- Depth	111	-	-	-	3 - 123 (-63 OFFSET)
VCF - LFO2	112	32	37	36	0 - 127 (-63 OFFSET)
KEYB - Spread	113	21	22	21	0 - 63
KEYB - Octave	114	-	-	-	0 - 4 (-2 OFFSET)
-	115	-	-	-	-
-	116	-	-	-	-
JOY - Y- Depth	117	-	-	-	3 - 123 (-63 OFFSET)
-	118	-	-	-	-
-	119	-	-	-	-
-	120	-	-	-	-
-	121	-	-	-	-
-	122	-	-	-	-
-	123	-	-	-	-
-	124	-	-	-	-
-	125	-	-	-	-
-	126	-	-	-	-
-	127	-	-	-	-

B

Appendix

Oscillator Waveforms

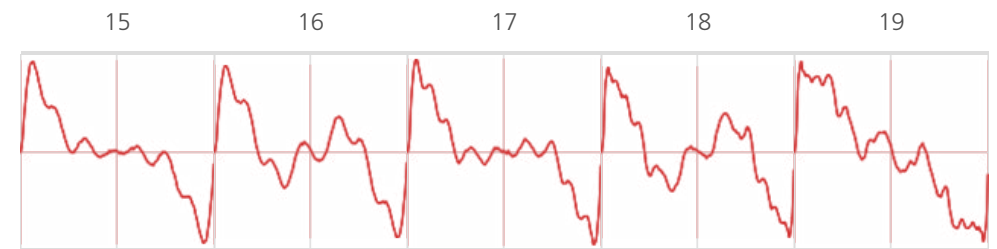
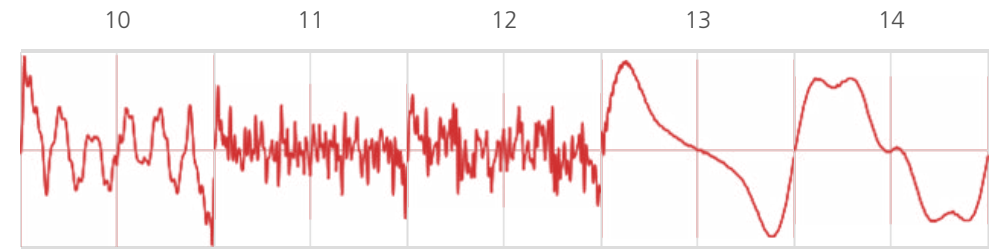
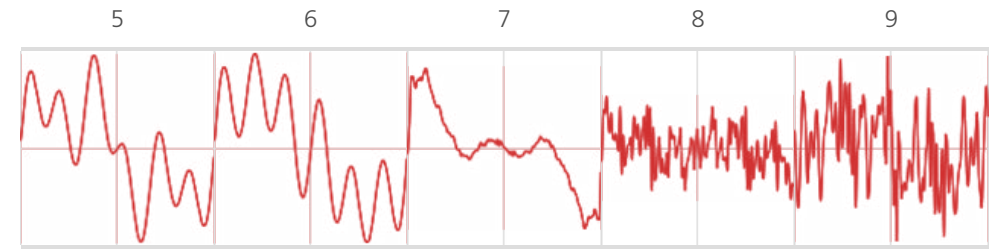
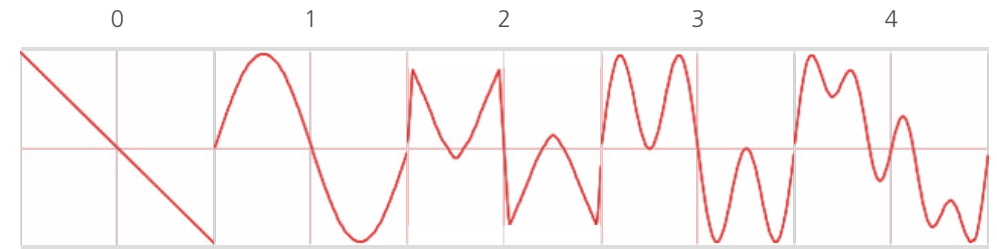

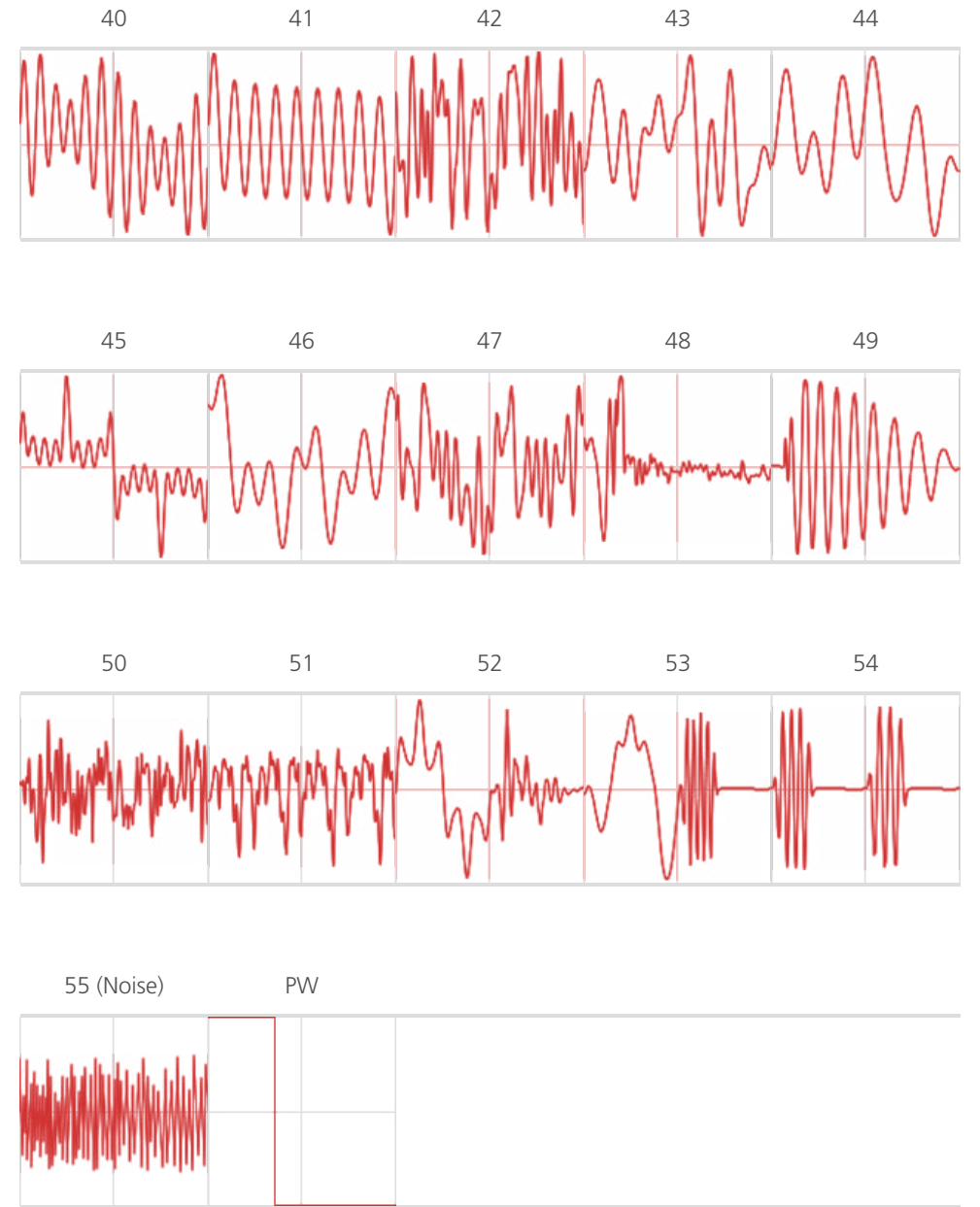

My synth doesn't boot

If your synth doesn't boot, please leave it off for few minutes, then try again: if the issue persists after 3-4 attempts, please contact support@modalelectronics.com.

I can't hear any sound

First of all, please check the volume knob is fully open, then try to load a new patch. If this doesn't help, you may want to check MIDI Settings and especially MIDI Local option, which should always be ON.

If this doesn't help either, a soft Reboot from the Settings should solve the problem.

The front panel has stopped responding

If you turn an encoder, neither the LCD screen updates nor can you hear the sound changing.

However, all the screen controls (i.e. keypad, 6 menu buttons, +/-/Select and DataWheel) should still be functioning.

If that is the case, then try to simply switch to the Settings page by pushing the sixth 'menu button' (F), then try to move another encoder: this should 'wake up' the synth.

If this doesn't help, try to load a new patch and do the same.

If this doesn't help either, a soft Reboot from the Settings should solve the problem.

The LCD screen has stopped responding

If you turn an encoder, you can hear the sound changing but the screen doesn't update.

Also, none of the screen controls (i.e. keypad, 6 menu buttons, +/-/Select and DataWheel) are working.

In this case, you have to physically reboot the unit (please always allow 60 seconds before switching the unit back on).

If the issue persists, please contact support@modalelectronics.com.

Troubleshooting FAQ's

Hung notes

If a voice has a hung note: to get rid of it, navigate to the keyboard page and change the key mode parameter.

I can't get any internet connection

If in the Network Settings you can't get any IP address, please press '5' to re-'Apply': you might need more than a couple of attempts before getting a result.

If this doesn't help, try to disconnect and re-connect the Ethernet cable to the 002R socket, then go to Settings and trigger a soft Reboot.

Other issues

If you experience any kind of odd behavior on your 002R, please contact support@modalelectronics.com : we can use the Remote Support feature to log into your unit to diagnose and fix potential problems.

D

Appendix

DB15 Pin Outs

1. Ground
2. Voice
3. Voice
4. Voice
5. Voice
6. Ground
7. Voice
8. Voice
9. Voice
10. Voice
11. Ground
12. Voice
13. Voice
14. Voice
15. Voice