



USER MANUAL

# AUDIOFUSE STUDIO

ADVANCED AUDIO INTERFACE

**ARTURIA**<sup>®</sup>  
YOUR EXPERIENCE • YOUR SOUND

# Special Thanks

---

## DIRECTION

---

Frederic BRUN                      Philippe CAVENEL

---

## HARDWARE DEVELOPMENT

---

Marc ANTIGNY                      Thierry HAUSER                      Léonard SAUGET  
Claire BOUVET                      Jérôme LAURENT

---

## SOFTWARE DEVELOPMENT

---

Timothée BEHETY                      Baptiste AUBRY                      Corentin COMTE  
Pierre PFISTER                      Simon CONAN

---

## DESIGN

---

Martin DUTASTA                      Morgan PERRIER                      Axel HARTMANN

---

## TESTING

---

Arnaud BARBIER                      Matthieu COUROUBLE                      Ludovic CIALDELLA  
Germain MARZIN                      Christophe TESSA                      Benoît GRELIER

---

## BETA TESTING

---

Luca LEFEVRE                      Chuck ZWICKY                      Boele GERKES                      Philippe BUTTOZ  
Terry MARSDEN                      Jay JANSSEN                      Marco CORREIA                      Guillaume COLLART  
Ken Flux PIERCE                      Ben EGGEHORN                      Randall LEE                      Grégory ROUDGÉ

---

## AUDIOFUSE CONTROL CENTER MANUAL

---

Randall LEE (author)                      Vincent LE HEN                      Charlotte METAIS                      Holger STEINBRINK  
Minoru KOIKE                      Camille DALEMANS                      Jose RENDON                      Jack VAN

---

## AUDIOFUSE STUDIO MANUAL

---

Leo Der Stepanians                      Minoru KOIKE                      Camille DALEMANS                      Jose RENDON  
(author)                      Vincent LE HEN                      Charlotte METAIS                      Holger STEINBRINK

© ARTURIA SA - 2020 - All rights reserved.  
26 avenue Jean Kuntzmann  
38330 Montbonnot-Saint-Martin  
FRANCE  
[www.arturia.com](http://www.arturia.com)

Information contained in this manual is subject to change without notice and does not represent a commitment on the part of Arturia. The software described in this manual is provided under the terms of a license agreement or non-disclosure agreement. The software license agreement specifies the terms and conditions for its lawful use. No part of this manual may be reproduced or transmitted in any form or by any purpose other than purchaser's personal use, without the express written permission of ARTURIA S.A.

All other products, logos or company names quoted in this manual are trademarks or registered trademarks of their respective owners.

**Product version: 1.0**

*Revision date: 17 March 2020*

# Important Safety Instructions

## PRECAUTIONS INCLUDE, BUT ARE NOT LIMITED TO, THE FOLLOWING:

1. Read and understand all the instructions.
2. Always follow the instructions on the device.
3. Before cleaning the device, always remove the USB and DC cable. When cleaning, use a soft and dry cloth. Do not use gasoline, alcohol, acetone, turpentine or any other organic solutions; do not use a liquid cleaner, spray or cloth that's too wet.
4. Do not use the device near water or moisture, such as a bathtub, sink, swimming pool or similar place.
5. Do not place the device in an unstable position where it might accidentally fall over.
6. Do not place heavy objects on the device. Do not block openings or vents of the device; these locations are used for air circulation to prevent the device from overheating. Do not place the device near a heat vent at any location with poor air circulation.
7. Do not open or insert anything into the device that may cause a fire or electrical shock.
8. Do not spill any kind of liquid onto the device.
9. Always take the device to a qualified service center. You will invalidate your warranty if you open and remove the cover, and improper assembly may cause electrical shock or other malfunctions.
10. Do not use the device with thunder and lightning present; it may cause electrical shock.
11. Do not expose the device to hot sunlight.
12. Do not use the device when there is a gas leak nearby.
13. Arturia is not responsible for any damage or data loss caused by improper operation of the device.

## Specifications subject to change:

The information contained in this manual is believed to be correct at the time of printing. However, Arturia reserves the right to change or modify any of the specifications without notice or obligation to update the hardware that has been purchased.

## IMPORTANT:

The product and its software, when used in combination with an amplifier, headphones or speakers, may be able to produce sound levels that could cause permanent hearing loss. DO NOT operate for long periods of time at a high level or at a level that is uncomfortable. If you encounter any hearing loss or ringing in the ears, you should consult an audiologist.

## NOTICE:

Service charges incurred due to a lack of knowledge relating to how a function or feature works (when the product is operating as designed) are not covered by the manufacturer's warranty, and are therefore the owner's responsibility. Please study this manual carefully and consult your dealer before requesting service.

## Thank you for purchasing an AudioFuse!

Each member of the AudioFuse family is a cutting-edge, pro audio interface with stellar sonic quality, an intuitive workflow, and a high return on your investment. They provide the superior sound of high-end analog studio consoles with all of the flexibility and connectivity you need for any recording or performance.

At the core of each device is Arturia's proprietary DiscretePRO® technology, which set new standards in audio excellence and affordability. For the technically-minded, there's a comprehensive description of the DiscretePRO® specifications [here](#).

This manual covers the features and operation of Arturia's **AudioFuse Control Center**, the companion software for the AudioFuse family. For additional information about the hardware, please read the owner's manual for your device.

# Introduction

Dear musician,

We'd like to thank you for purchasing one of the members of our AudioFuse family! These audio interfaces are anything but ordinary; they have been constructed using components of the utmost quality so as to achieve recordings of the utmost quality. This level of crystal clarity is unprecedented in their price range!

This manual will help you make the most of your AudioFuse device by using the AudioFuse Control Center, the powerful companion software we designed to work with the entire AudioFuse series.

The AudioFuse Control Center does much more than simply give you another way to tweak the front panel controls; it also provides access to parameters and routing options that are not available from the front panel.

If you are reading this manual and have not already downloaded the AudioFuse Control Center, you can find it here: [AudioFuse Control Center](#).

Be sure to visit the [www.arturia.com](http://www.arturia.com) website for information about all of our other great hardware and software instruments. They have proven time and again to be the go-to solutions for musicians around the world.

Musically yours,

**The Arturia team**

# Table Of Contents

1. AudioFuse Studio .....	3
1.1. Overview .....	3
1.1.1. Box Contents.....	3
1.1.2. DiscretePRO® certificate.....	3
1.1.3. Register your AudioFuse Studio.....	4
1.2. Hardware Features.....	4
1.2.1. Top View .....	4
1.2.2. Front View .....	10
1.2.3. Back View.....	11
1.3. Getting started.....	13
1.3.1. Powering your AudioFuse Studio.....	13
1.3.2. Setting your Operating System.....	13
1.3.2.1. Setup on macOS.....	13
1.3.2.2. Set up on Windows.....	14
1.3.2.3. Set up on iPad/iPhone.....	14
1.3.2.4. Set up on Android.....	14
1.3.3. The AudioFuse Control Center.....	15
1.4. How to use AudioFuse Studio.....	16
1.4.1. How to record with a microphone.....	16
1.4.2. How to record a synth, guitar or other instrument.....	17
1.4.3. Inserting external effects into your signal path.....	18
1.4.3.1. About TRS to Dual-TS Cables.....	18
1.4.4. Re-Amping .....	20
1.4.5. Use one headphone for Cue, and one for Main.....	21
1.4.6. Use AudioFuse to switch between 2 sets of active speakers.....	22
1.4.7. Connect to AudioFuse Studio with Bluetooth .....	23
1.4.8. Use AudioFuse Studio without a computer.....	24
1.4.9. Using Phones 2 to Control Speaker B.....	24
1.4.10. Loopback Mode.....	24
1.4.11. Talkback on ADAT 1-2.....	24
1.4.12. SPDIF Out from Speaker.....	25
1.4.13. AUX outputs from Inputs 1-4 (and DAW).....	25
1.5. An in-depth look at AudioFuse Studio.....	26
1.5.1. Input Paths in Detail.....	26
1.5.1.1. Input Channels 1 - 4 .....	26
1.5.1.2. Inputs 5 - 6 .....	27
1.5.1.3. Inputs 7 - 8 .....	28
1.5.1.4. Digital inputs.....	29
1.5.2. Monitor Mixing and Routing .....	30
1.5.3. Creating a Monitor Mix .....	30
1.5.4. Routing Monitor Mixes to speakers and headphones.....	30
1.5.5. USB Audio mapping .....	31
1.5.5.1. Audio Mapping at 44.1 / 48 kHz sampling rates.....	31
1.5.5.2. Audio Mapping at 88.2 / 96 kHz sampling rates.....	32
1.5.5.3. Audio Mapping at 176.4 / 192 kHz sampling rates.....	32
1.5.6. Clock Synchronization .....	33
1.5.6.1. Using the Internal Clock.....	33
1.5.6.2. Using External Clock Sources.....	34
1.6. Specifications.....	35
2. AudioFuse Control Center.....	38
2.1. Welcome to AudioFuse Control Center!.....	38
2.2. Overview .....	38
2.2.1. The Main window.....	38
2.2.1.1. Two-way communication.....	38
2.2.1.2. Basic operations.....	39
2.2.2. The AudioFuse Studio window.....	40
2.2.2.1. AudioFuse Studio controls not in AFCC.....	40
2.3. The Menu bar .....	42
2.3.1. The Arturia menu .....	42
2.3.1.1. Resize Window.....	42

2.3.1.2. AFCC Manual .....	43
2.3.1.3. About.....	43
<b>2.3.2. Device Selection.....</b>	<b>44</b>
<b>2.3.3. Device Status .....</b>	<b>44</b>
<b>2.3.4. Device Settings .....</b>	<b>45</b>
2.3.4.1. Audio Settings .....	45
2.3.4.2. Preferences .....	50
<b>2.3.5. Firmware Updates.....</b>	<b>52</b>
<b>2.4. The Main Window .....</b>	<b>53</b>
<b>2.4.1. Input zone.....</b>	<b>53</b>
2.4.1.1. Analog Inputs.....	53
2.4.1.2. Digital Inputs .....	54
<b>2.4.2. Monitoring Mix zone .....</b>	<b>55</b>
2.4.2.1. The Channel display .....	55
2.4.2.2. The Master level fader .....	56
<b>2.4.3. Output zone.....</b>	<b>59</b>
2.4.3.1. Analog Outputs .....	59
2.4.3.2. Digital Outputs.....	60
2.4.3.3. Loopback section .....	61
<b>3. Software License Agreement.....</b>	<b>62</b>
<b>4. Declaration of Conformity .....</b>	<b>64</b>



# 1. AUDIOFUSE STUDIO

## 1.1. Overview

### 1.1.1. Box Contents

- AudioFuse Studio Advanced Audio Interface
- "Worldwide" power supply with interchangeable leads
- 2x USB cables (USB-C to USB-C, USB-C to USB-A)
- 2x MIDI Adaptors
- Quick Start Guide
- Registration card with Serial and Unlock Code
- DiscretePro® certificate

### 1.1.2. DiscretePRO® certificate

Your AudioFuse Studio comes with 4 preamplifiers using our DiscretePRO® technology to ensure the best audio quality when recording. Your AudioFuse Studio is unique and therefore it comes with its own Audio Precision certificate as a guarantee of its performance.



A version of this certificate with more details is available after registration on [www.arturia.com/register](http://www.arturia.com/register)

### 1.1.3. Register your AudioFuse Studio

**Be sure to register your AudioFuse Studio as soon as possible!** There is a sticker in the Quick Start Guide and on the bottom panel of the product that contains the serial number of your unit and an unlock code. These are required during the online registration process. You may want to record these elsewhere or take a photo of the sticker in case it becomes damaged.

Registering your AudioFuse Studio provides the following benefits:

- Free software license for the AudioFuse Creative Suite, an ever-evolving collection of software effects and instruments that will let you add your own unique signature to your music
- Access to the latest version of the AudioFuse Control Center software
- Special offers restricted to AudioFuse Studio owners

## 1.2. Hardware Features

### 1.2.1. Top View

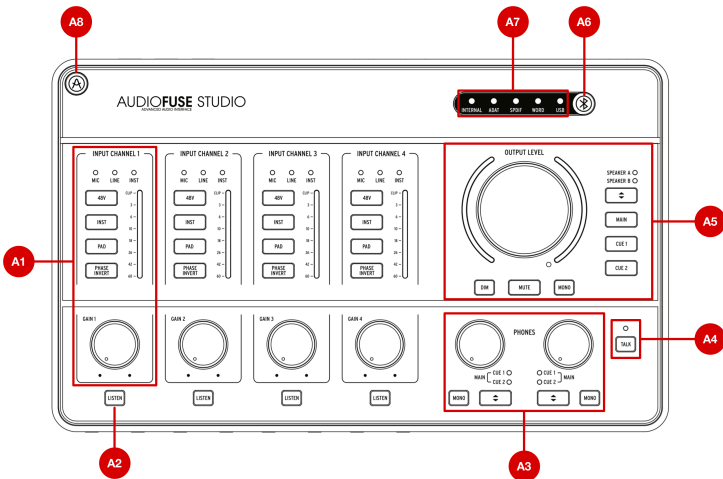

**A1. Input control section (Input Channel 1-4):** This section contains all features relating to AudioFuse Studio's Input Channels 1-4 with their pristine DiscretePro preamplifiers. The controls and indicators on are identical on all four channels and are as follows:

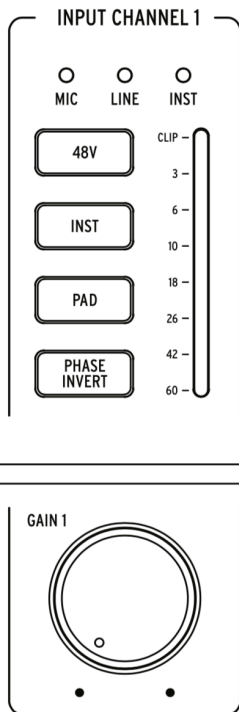

- **Mic/Line/Inst Indicators:** One of these LEDs automatically illuminates when you plug in a sound source into AudioFuse Studio's front panel inputs.
  - If an XLR cable is plugged in, *Mic* is illuminated and all microphone-related functions become available on the buttons below (*48V*, *Pad*, *Boost* and *Phase Invert*).
  - If a 1/4" cable is plugged in, the *Line* or *Inst* LED illuminates and you can switch between modes by pressing the "Inst" button. Again, only the appropriate options are made available on the buttons below (*Inst*, *Pad* and *Phase Invert*).
- **Gain:** This knob sets the input gain of the channel's DiscretePro preamplifier. Use each channel's VU-meter to ensure your gain levels are set properly.
- **VU-Meter:** These LEDs indicate the level of the incoming signals after the DiscretePro preamplifier. Use this in conjunction with the Gain knob to make sure your levels are set properly. Ideally your incoming signal should peak between the -10 and -6dB LEDs. If you are seeing the Clip LED light up then reduce the input gain to prevent clipping (unwanted distortion).



Some high output devices may require engaging the Pad to prevent clipping (see below).

- **48V:** This button engages and disengages 48V phantom power for microphones requiring power. Note that this button only works when an XLR cable is plugged into AudioFuse Studio. The button is ignored when 1/4" devices (Instrument or Line-level) are plugged in, or when nothing is connected to the XLR connector.
- **Inst:** This button lets you toggle between Line and Instrument modes. Line mode accepts standard line-level signals provided by most audio devices (synthesizers, drum machines, studio and HiFi gear, etc.) Instrument mode changes the impedance of the 1/4" instrument input to Hi-Z (high impedance). This is designed to be used with instruments that have passive pickups, such as electric guitars and basses, stringed instruments (mandolin, violin, etc.), and electric pianos (reed or tine-based). If you're connecting an instrument like the ones described, activate Inst mode for the best possible sound.

**i**!: If your instrument has "active" electronics or you're using an external preamp or stomp box before recording the signal with AudioFuse Studio, you may not need to use Inst mode at all. Feel free to experiment and see if you notice an improvement in your sound.

- **Pad:** This button engages and disengages input gain padding, which reduces the incoming signal levels by 20 dB before they reach AudioFuse Studio's preamplifier. Switch this on when recording high output instruments or microphones that overload the AudioFuse Studio's preamplifier even at minimum gain settings.

**i**!: AudioFuse Studio has a hidden microphone **Boost** mode that can be switched on by holding down the Pad button for one second (the button will be illuminated in red when Boost mode is active). This is a special mode that provides +10 dB *extra* gain to incoming microphone signals and can be handy when using microphones with low outputs (such as the popular Shure SM7B, for example) or when recording very faint sounds. If your microphone has a reasonable output level (most modern microphones do) then we recommend leaving Boost off to ensure the best possible sound. Note that this mode is only available when XLR microphones are connected and it cannot be engaged when 1/4" devices are connected.

- **Phase Invert:** This button inverts the phase of the incoming signal. Phase inversion is very useful in certain situations, such as when you are using two or more microphones to record an instrument. For example, let's say you are recording a guitar amp with a microphone that is close to the speaker and another microphone that is placed further away to capture the sound of the room. You may notice that certain frequencies are being overemphasized (or de-emphasized) due to phase cancellation caused by the spacing between the microphones. If so, try pressing the Phase button on just one of your channels (not both). By inverting the signal on one of your microphones, you may immediately resolve the phase cancellation issue. If this does not provide satisfactory results, you will need to move the room mic to a slightly different location.

**A2. Listen Button:** This button lets you listen to a specific Input Channel (or multiple Input Channels) without distraction by muting audio coming from the computer.

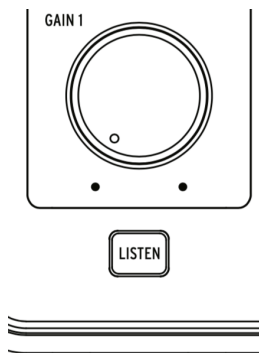

This functionality lets you really focus in and hear what is being recorded without having to hear anything else. Press the button to switch Listen mode on and off. The button is illuminated when the mode is active.

**i** **🎵**: The functionality of this button can be adjusted in the AudioFuse Control Center application under Settings (Gear Icon) > Audio Settings > Listen button. Please refer to the AudioFuse Control Center section for more information: [here \[p.45\]](#).

**A3. Phones Control Section:** This section contains two identical sets of controls pertaining to the headphone outputs on the front panel (see callout B2).

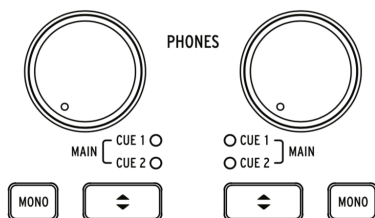

- **Level Knob:** This knob sets the level for its associated headphone outputs.
- **Mono Button:** This button engages and disengages Mono mixdown mode for its associated headphone output. When switched on, the button is lit and the headphone mix is heard in mono. When switched off, the mix is heard in stereo (or as recorded)

**i** **🎵**: Being able to quickly monitor in mono can be a very useful feature in both recording and mixing situations. While recording, singers sometimes prefer to perform with headphones only on one ear so that they can hear themselves better. A mono mix ensures that the singer hears everything in the mix even if they are only using one ear to hear playback. During a mixing session, many engineers check for spectral balance and phase problems by listening to a mono mix. In both cases, the Mono button provides an easy way to temporarily monitor in mono.

- **Cue Select Buttons:** These buttons select the audio source for the headphone output by stepping through the three mix sources: *Cue 1*, *Cue 2*, and *Main*. These mixes can be edited in the AudioFuse Control Center application. Please refer to the AudioFuse Control Center User Manual to learn how to do this.

**A4. Talkback:** AudioFuse Studio contains a small "talkback" microphone inside its case. This convenient feature lets you easily communicate with your performer if he/she is in another room during the recording process. To use this feature, simply hold the Talkback button and start talking. The built-in microphone can then send your voice to the talent's headphones (or other destination of your choosing) so that the performer can hear your comments or instructions from the control room. The level and routing of the talkback microphone can be configured in the AudioFuse Control Center software under Settings (Gear Icon) > Audio Settings > Talkback. Please refer to the [AudioFuse Control Center section \[p.45\]](#) for more information.

**i** Please note the Talkback uses Analog Input 8. It is possible to set TalkBack mode to avoid activating the Talkback if the Input 8 is already in use. Please refer to the AudioFuse Control Center section for more information:[here \[p.45\]](#).

**A5. Output Section:** This section contains controls pertaining to the speaker outputs. Here you will find things like a master volume knob, VU meters, and other switching, routing, muting and dimming functions.

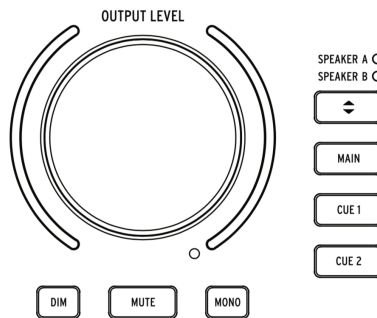

- **Master Volume Knob:** This encoder sets the loudness of the active set of speakers. Note that Speakers A and B can be adjusted independently or linked so that loudness differences are maintained when switching back and forth. Linking functionality is described in the AudioFuse Control Center application. Please refer to that [application's User Manual \[p.45\]](#) to learn more.
- **VU Meters:** By default, these LED meters display the loudness level of incoming mixes (Main, Cue 1, or Cue 2) or any Input channels that have "Listen" mode engaged. When adjusting the Master Volume knob, these LEDs temporarily turn blue to show the position of the knob from minimum (bottom) to maximum (top).
- **Dim:** Pressing this button reduces the speaker level and is commonly used when having discussions or taking a phone call. By default, the sound level is reduced by 20 dB but this can be adjusted in the AudioFuse Control Center application.
- **Mute:** This button mutes the output being sent to the speakers.
- **Mono:** This button switches on Mono mixdown mode. When switched on, the button is lit and the mix is downmixed to mono.

**i**: During a mixing session, many engineers like to perform a "mono compatibility" check to ensure that mixes will translate well onto mono sources (like many phones, laptops or portable Bluetooth speakers). It is also easier to spot spectral balance problems and phase-related issues in mono. The Mono button provides an easy way to ensure a mix will translate well.

- **Speaker Selector:** This button lets you easily A/B your mix on two different sets of speakers. The currently active speaker is indicated by its corresponding LED.
- **Main / Cue 1 / Cue 2 buttons:** These three buttons select which mix is sent to your speakers. The three mixes can be adjusted in the AudioFuse Control Center software. Please refer to that [application's User Manual \[p.30\]](#) to learn more.

**A6. Bluetooth Button:** This button switches Bluetooth functionality on and off. When switched on, the button is illuminated and the Bluetooth audio stream is decoded by the AudioFuse Studio. The AudioFuse Studio is discoverable by Bluetooth enabled devices like your smartphone or tablet. This allows you to wirelessly connect to AudioFuse Studio so you can play music through the studio's sound system. The routing of incoming Bluetooth signals can be configured in the AudioFuse Control Center software under Settings (Gear Icon) > Audio Settings > Bluetooth. Please refer to the [AudioFuse Control Center User Manual \[p.45\]](#) for more information.

**i**: A long press on the Bluetooth button resets the on-going connection and enables pairing with a new device.

**A7. Clock Source and USB Indicators:** These LEDs indicate the source of the digital clock (internal, ADAT, SPDIF or Word Clock) and the status of the USB connection.



The USB LED is illuminated when the connection is OK and blinks if there is either a problem with the USB connection or there is no USB connection at all to the computer. You can select the clock source of AudioFuse Studio in the AudioFuse Control Center software under Settings (Gear Icon) > Audio Settings > Clocks. The selected external clock LED blinks if lost or incorrect. In this situation, the unit automatically switches to Internal clock at the same sample rate. Please refer to the [AudioFuse Control Center User Manual \[p.45\]](#) for more information.

**A8. AudioFuse Studio Button:** This button opens and closes the AudioFuse Control Center on your computer.



It is a handy shortcut to accessing the Control Center application without having to use your computer's mouse or trackpad.

## 1.2.2. Front View

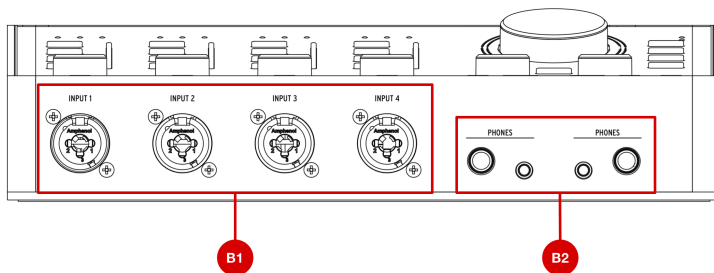

**B1. Input channels 1-4:** Connect microphones, instruments or line-level devices to these four inputs. The "combo" style connectors accept XLR (microphone) or 1/4" (instrument or line-level) inputs. Each channel has its own Input Control Section directly above it on the front panel so you can set things like input gain or monitor incoming levels. See callout A1 above to learn more about the Input Control Section.

**B2. Headphone Outputs:** Connect your headphones here. AudioFuse Studio has two independent headphone ("cue") outputs and each output has both 1/4" and 1/8" connectors so you never have to worry about losing headphone adapters. The Phones Control Section directly above these connectors on the front panel lets you set the output level, select the signal source and set mono/stereo operation. Refer to callout A3 above to learn more about the Phones Control Section.

**i** 🎵 The 1/4" and 1/8" headphone outputs have different impedance values so that you can connect virtually any kind of headphone to AudioFuse Studio. The 1/4" are optimized for high impedance headphones (30-600 ohm) and have a 13 dBu maximum output level. The 1/8" connectors are optimized for low impedance headphones (8-120 ohm) and have a 10 dBu maximum output level.



### 1.2.3. Back View

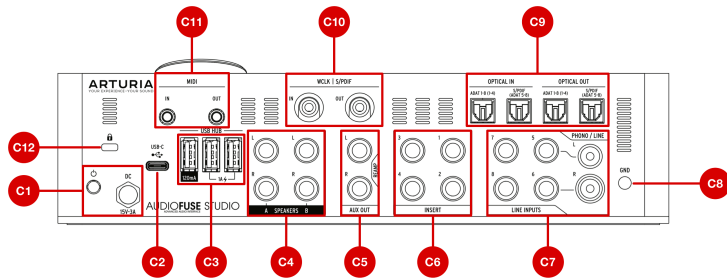

**C1. Power Section:** Connect the supplied DC power adapter here and use the nearby power button to switch the product on and off. The threaded connector can be locked into place to avoid accidentally disconnecting the power. To make life easier for international travelers, the "worldwide" power supply includes interchangeable leads letting you use the product nearly anywhere in the world without having to buy adapters or power converters.

**i**!: AudioFuse Studio is intended to be used with its supplied DC power supply. While the interface can be "bus powered" by your computer through the USB-C connector, most of its functionality must be switched off as USB cannot deliver enough current to power the unit. When bus powered, the interface works as a dual headphone amplifier with reference grade digital-to-analog conversion. All other features (USB hub, preamplifiers, speaker outputs, etc.) are switched off. It is important to note some computer may not have the capability to provide enough power for this "bus powered" mode.

**C2. USB-C Connector:** Connect AudioFuse Studio to your computer with one of the provided USB cables. AudioFuse Studio features a USB 2.0 protocol to communicate with your computer. It can also work with many smartphone and tablets but these devices may require specialized USB adapters to make the connection. This is detailed in the next chapter of this guide.

**C3. USB hub:** AudioFuse includes a handy 3-port USB hub to connect your master keyboard, USB memory stick or dongle. Two of the ports (labeled "1A") can deliver up to 1 amp of power for rapid charging of devices. The third port provides up to 120mA of current is intended for low power devices such a dongle or USB memory stick.

**i**!: We advise only connecting products with low power requirements (such as USB dongles) to the 120mA port. Connecting devices with higher power requirements may trigger an overcurrent protection mechanism that will temporarily deactivate the 120mA port. If you wish to connect products with more demanding power requirements, use the 1A ports instead.

**C4. Speaker Outputs A&B:** Connect up to two pairs of active speakers to these balanced 1/4" outputs for easy A/B monitoring. The Output Control Section on the top panel lets you do things like select the active pair of speakers, set output levels, select the sound source of the speakers and more. See callout A5 above to learn more about the Output Control Section.

**C5. Aux (Reamp) Output:** These multi-tasking outputs have some special features not typically found on other interfaces. Firstly, they are DC coupled, letting you control of modular synths directly from your DAW audio or control voltage (CV) signals. Secondly, these outputs can change impedance and allow you to send a "dry" recorded guitar or bass track back out to any amp for rerecording (or "reamping") later. This handy feature opens up many interesting sound design possibilities and saves you from having to buy costly "DI" or "reamping" boxes.

**C6. Insert Section:** These connectors let you "insert" external line-level devices such as compressors into the signal path after the AudioFuse Studio's DiscretePro preamplifiers but before its analog-to-digital converters. To do this, you will need to use TRS "send/return" cables. If nothing is connected here, the DiscretePro preamp's output is automatically sent to the digital converter.

**C7. Phono/Line inputs 5-8:** Connect external phono or line-level devices to these RCA and balanced 1/4" inputs. The Phono input may not be suitable for high cartridge output levels (typically above 5-10 mV). The AudioFuse Control Center application lets you configure the RCA inputs to accept either standard line-level signals (like the output of your smartphone, for example) or the output of a turntable requiring RIAA-equalization. This is done on the main screen under the Analog Inputs > Inputs 5-6 section. Please refer to the [AudioFuse Control Center User Manual \[p.53\]](#) to learn more.

**i**: These inputs connect directly to the AudioFuse Studio's pristine analog-to-digital converters (unless the RIAA filter is switched on inputs 5-6, in which case the signal flows through that filter first). If you own fancy "outboard" products like a tube preamp or a vocal strip, connect them here avoid double-amplifying your signals (once through your preamp and again through the DiscretePro preamp). Doing so will provide the cleanest possible signal path and also leaves the DiscretePro preamplifiers free to capture other signals.

**C8. Grounding Pin:** This pin is used in conjunction with the Phono inputs to create a common ground between a turntable and the AudioFuse Studio. Be sure to always use the grounding pin when connecting a turntable to help you avoid ground hum loops, buzzes and other unwanted sounds in your recordings.

**C9. Optical Input/Output Section:** These connectors can be used to transmit and receive ADAT and S/PDIF signals over optical cables. ADAT is a multi-channel format that carries up to 8 channels of audio whereas S/PDIF always carries stereo (2-channel) signals. The exact functioning of this output is configured in the AudioFuse Control Center software under Settings (Gear Icon) > Audio Settings > Digital I/O. Please refer to the [AudioFuse Control Center User Manual \[p.45\]](#) for more information.

**i**: The ADAT standard supports up to 8 channels of audio at sampling rates of 44.1/48k. However, when working at higher sampling rates (88.2k or 96k) each optical cable can only carry 4 channels of audio (the format does not support 176.4k or 192k sampling rates). To overcome this limitation, AudioFuse Studio has two separate input connectors and two separate output connectors, letting you to transfer 8 channels of ADAT signals even if you are working at 88.2k or 96k sampling rates.

**C10. WordClock & S/PDIF Section:** These connectors can be used to transmit and receive coaxial (RCA) S/PDIF signals as well as Word Clock synchronization signals. Use the AudioFuse Control Center to define how you would like these connectors to operate. Refer to that [application's User Manual \[p.45\]](#) to learn more.

**C11. MIDI In/Out:** Connect MIDI devices here using the supplied MIDI Adapters. The MIDI ports are available in your computer once the AudioFuse drivers are installed (these drivers are installed along with the AudioFuse Control Center application).

**C12. Kensington Lock Port:** AudioFuse Studio is portable and easy to carry. However, it should be carried away only when you want it carried away! We've included a Kensington lock slot on the rear panel so you can secure it to the surface of your choice.

## 1.3. Getting started

### 1.3.1. Powering your AudioFuse Studio

AudioFuse Studio is a professional-grade recording interface and it has higher power requirements than most consumer products. For this reason, it must be powered using its included worldwide DC power supply (15V, 3A).

### 1.3.2. Setting your Operating System

#### 1.3.2.1. Setup on macOS

Connect AudioFuse Studio to your computer's USB Port and switch on the unit. AudioFuse Studio will appear in the *Audio MIDI Setup* as shown:

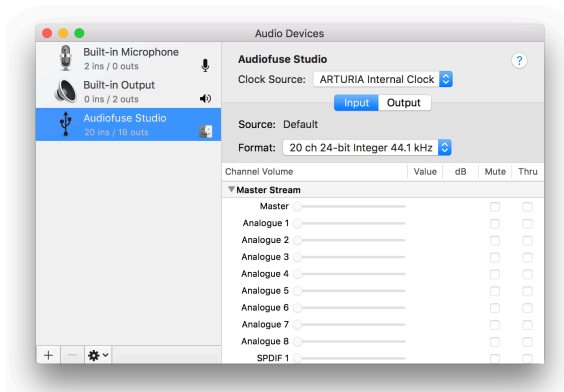

To set up AudioFuse Studio to work as your default audio input/output device:

- Select AudioFuse Studio in the Audio MIDI Settings left panel
- Right-click AudioFuse Studio and set it as default input device
- Right-click AudioFuse Studio again and now set it as default output device

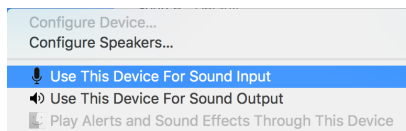

### 1.3.2.2. Set up on Windows

Low latency drivers on Windows are provided by Arturia and are automatically installed with the AudioFuse Control Center installer. You can download AudioFuse Control Center here:

[www.arturia.com/audiosfuse-start](http://www.arturia.com/audiosfuse-start)

Once AudioFuse Control Center is installed, simply connect the interface to your computer using the supplied USB cable and switch on the unit. Windows will detect the hardware and it will appear under your audio devices.

Open “Manage Audio Device”

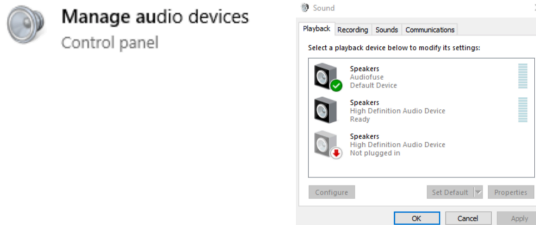

Here you can configure AudioFuse Studio to be your default recording device, playback device or both. To do so, select the interface under the *Playback* and *Recording* tabs and press the *Set Default* button.

### 1.3.2.3. Set up on iPad/iPhone

First, connect AudioFuse Studio to its DC adaptor and switch on the unit. Next, connect AudioFuse Studio to your iOS device through the camera connection kit (required). AudioFuse Studio will appear under Settings > General > About > AudioFuse. For more information please refer to [www.arturia.com/audiosfuse-start](http://www.arturia.com/audiosfuse-start)

### 1.3.2.4. Set up on Android

First, connect AudioFuse Studio to its DC adaptor and switch on the unit. Next, connect the interface to an Android device through an On-The-Go cable. Android 5+ is required. For more information please refer to [www.arturia.com/audiosfuse-start](http://www.arturia.com/audiosfuse-start)

### 1.3.3. The AudioFuse Control Center



Our AudioFuse Control Center (AFCC) software lets you to dive deep into the AudioFuse Studio's features and to manage all the special functions that are not directly accessible from the top panel. For example you can modify the *Main*, *Cue 1* and *Cue 2* monitor mixes, modify digital input/output settings, select the digital clock source, update the product's firmware and much more. In short, AFCC lets you reconfigure the interface so that it works best for you and your studio. All of AFCC's powerful features are covered in [section 2 \[p.38\]](#) of this user guide.

## 1.4. How to use AudioFuse Studio

### 1.4.1. How to record with a microphone

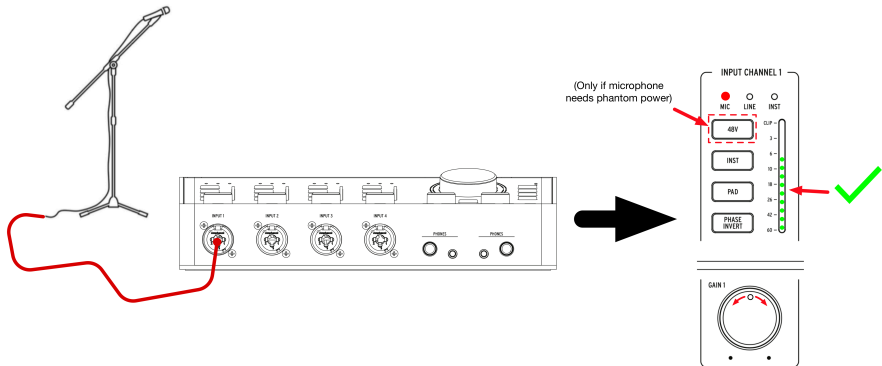

1. Connect your microphone to AudioFuse Studio with an XLR cable. You can use any input on the front panel.
2. AudioFuse Studio will auto-detect that you have connected an XLR cable and the Mic LED will light up in the Input Channel section.
3. If your microphone requires phantom power, press the 48V button to switch on phantom power.
4. Talk or sing into the mic while adjusting the gain knob. The loudest parts of your performance should cause the channel's VU meter to peak between -10 and -6dB.
5. If your sound source is so loud that it overloads the VU meter even at the lowest gain setting, press the Pad button to switch on the 20dB input gain reduction. Note that the CLIP LED will light up when the input signal reaches 1dB before distortion.

That's it! The microphone input should be available in your music software and ready to record. Please refer to your software's user guide if you have any questions about how to record.

## 1.4.2. How to record a synth, guitar or other instrument

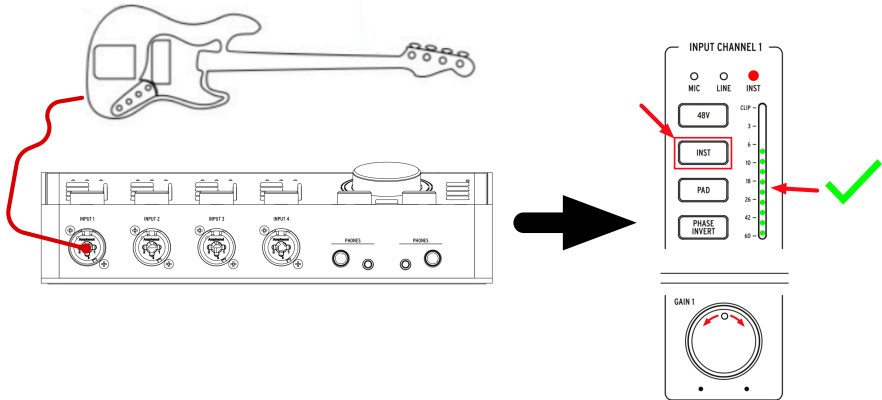

1. Connect your synth, guitar or other instrument with a standard 1/4" cable. You can use any input on the front panel.
2. AudioFuse Studio will auto-detect that you have connected a 1/4" cable and either the *Line* or *Inst* LED will light up in the Input Channel section.
3. Press the Inst button to ensure that the right kind of input device (line-level or instrument) is selected:
  - If you are using a line-level instrument (synthesizers, drum machines and most studio or hifi equipment) then the "Line" LED should be illuminated.
  - If you have connected an electric guitar, bass, or another kind of instrument with passive pickups then the "Inst" LED should be illuminated.
4. Play the instrument while adjusting the gain knob. The loudest parts of your performance should cause the channel's VU meter to peak between -10 and -6dB. Please note that the Pad is activated by default when a channel is in Line mode.
5. If your sound source is so loud that it overloads the VU meter even at the lowest gain setting, press the Pad button to switch on the 20dB input gain reduction. Please note that the PAD is activated by default in Line mode

You're all set! You should now be able to see your instrument in your music software and be ready to record. Please refer to your software's user guide if you have any questions about how to record.

### 1.4.3. Inserting external effects into your signal path

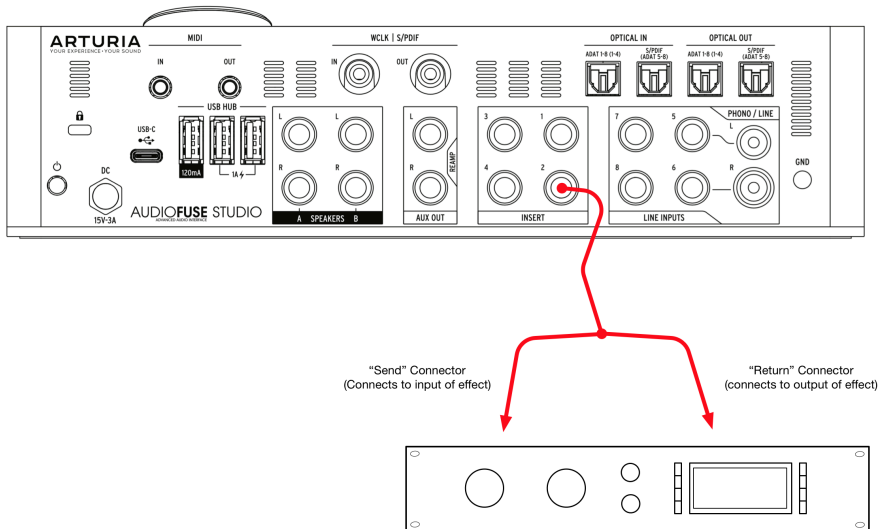

It is sometimes very desirable to insert a compressor, equalizer or other effect into your analog signal path before converting it to digital and sending it into your computer to be recorded. The Insert connectors on the back of AudioFuse Studio make this easy.

1. Connect your microphone or instrument to AudioFuse Studio by following the instructions in the two sections above.
2. Use a special TRS to dual-TS "insert" cable to inject your external device into the signal path. The cable's "send" connector goes to your external device's input. The "return" connector should be connected to your external device's output and brings the signal back into AudioFuse Studio.
3. External devices can sometimes shift your loudness levels up or down so you may need to adjust the device's output to ensure your peaks are still between -10 and -6dB. Use can use the VU meters on AudioFuse Studio to confirm that input levels are good.

Job done! Your signal is now being routed from the DiscretePro preamp's output through the external device and back to AudioFuse Studio's pristine analog-to-digital converter.

**i** Tip: Here is a Pro Tip: It's possible to send line level signals directly to the converters (and bypass the DiscretePro preamplifiers) by only using the "return" portion of an insert cable and leaving the "send" connector unplugged. You can also take the output of DiscretePro preamplifier by only using the "send" portion of the cable while leaving the "return" portion unplugged. Technically minded engineers may be interested to know that these inserts send and receive signals at line level (+18 dBu for 0 dBFS).

#### 1.4.3.1. About TRS to Dual-TS Cables

Insert cables are a special category of cables that allow mixers and other devices to send and receive signals on the same physical connector. This is done through a clever use of a balanced TRS (tip-ring-sleeve) cable containing three internal wires.



These cables normally connect one TRS connector to another TRS connector. In this scenario, a signal is sent "one way" along the cable with the positive and negative polarities of an identical signal being sent on the "tip" and "ring" and a common ground being provided on the sleeve.

When using insert cables, the tip of the cable is instead used to "send" the signal to an external device whereas the middle "ring" is used to bring signal back. The third "sleeve" is used to provide a common ground as it normally is used.

## 1.4.4. Re-Amping

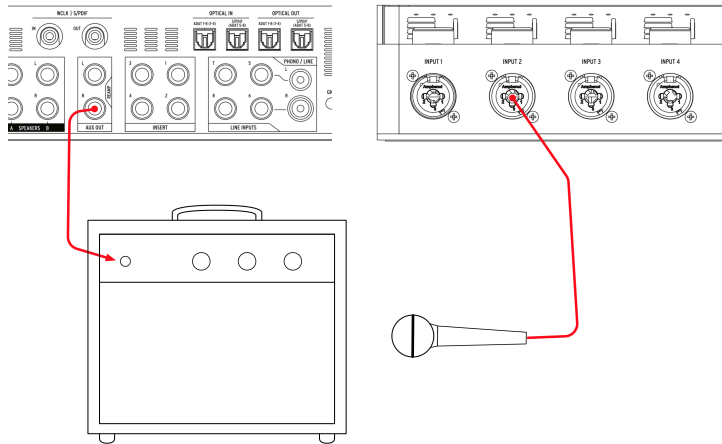

AudioFuse has a great Re-amping function that opens up many creative options when mixing. Re-amping is sometimes called "reverse D.I." and is when you play a dry (sometimes called "direct" or "D.I.") recorded guitar or bass track back out to an amplifier to record the result. This lets you play the exact same guitar or bass performance through several different amplifiers (or the same amplifier set to different settings) and capture the amplified sounds as usual with microphones. Having the ability to re-record the same performance through different amplifiers lets you create really interesting mixes such as:

- Mixing low frequency growl of one amp with the high frequency sparkle of another for the perfect guitar tone
- Hearing two different amps panned left and right but playing an *identical* performance
- Re-recording a great performance through a different amp long after the session has ended

**i**!: Note that it is not possible to simply play a standard line-level signal into an amplifier since amplifiers expect to see a high-impedance (Hi-Z) instrument level signal. Playing a regular line-level signal will generate sub-optimal results due to the impedance and level mismatch between what is played and what is expected at the amp. To re-amp properly, the proper reverse DI circuitry must be in place like with AudioFuse Studio.

To do this:

1. Make a "direct" recording of a guitar or bass in your music software. This is done by plugging the instrument directly into one of the AudioFuse Studio's front panel inputs (this process is described earlier in this chapter).
2. Set the Aux outputs of AudioFuse Studio to function as re-amping outputs. This can be done through the AudioFuse Control Center application. Refer to that [software's User Manual \[p.59\]](#) to learn how to do this.
3. Connect the re-amping outputs to your amplifier.
4. Playback the direct recording to the amplifier while recording the output of the amplifier with a microphone (this is described earlier in this chapter).

### 1.4.5. Use one headphone for Cue, and one for Main

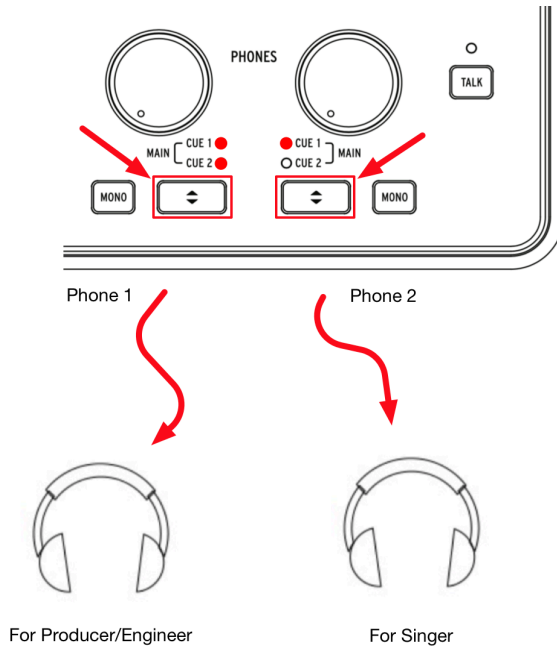

Since AudioFuse Studio has two independent headphone outputs, you can monitor two separate mixes at the same time. For example, the producer or engineer can hear the main mix while a vocalist can listen to a special mix designed to help them sing at their best.

1. Use the Cue Select buttons to select the Main mix on headphone output 1 and Cue 1 (or Cue 2) on headphone output 2.
2. Use the Headphone Level knobs to adjust the volume for each set of headphones.
3. The Main, Cue 1 and Cue 2 mixes can be modified using the AudioFuse Control Center application. Please refer to that software's User Manual to learn how to do this.

## 1.4.6. Use AudioFuse to switch between 2 sets of active speakers

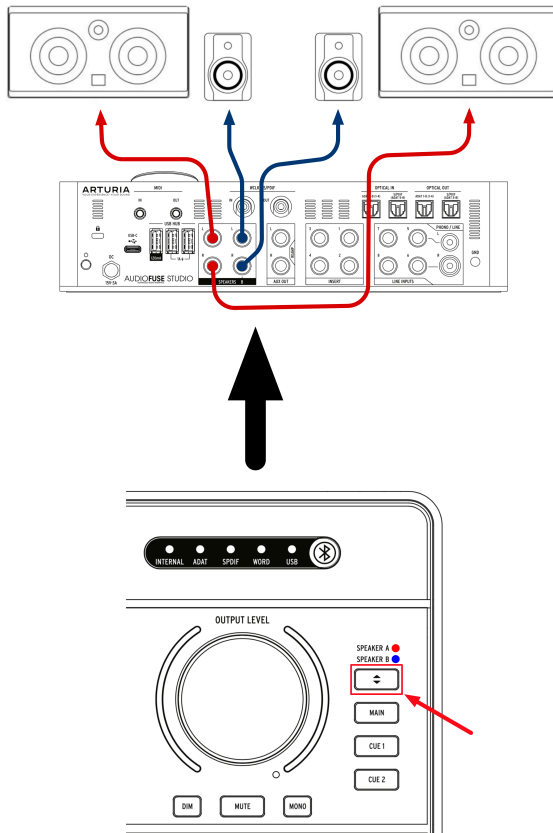

It is common practice for recording engineers to audition their mixes on different speakers as they work. For example, they may have professional studio monitors as their main speakers but a pair of cheap hi-fi speakers as a "reality check" to ensure that the mix is sounding good even on lower quality speakers. Other engineers may have professional studio monitors as their main speakers but a massive PA speaker system for visiting clients that like to hear it turned up loud.

The Speaker A and Speaker B outputs on AudioFuse Studio make doing this very easy.

1. Connect your main speakers to Speaker Output A
2. Connect your second set of speakers to Speaker Output B
3. Press the Speaker Selector button to switch between your two pairs of speakers.

**i** The AudioFuse Control Center application includes a trim knob that lets you precisely match loudness levels between your A and B speakers. Please refer to the [AudioFuse control Center User Manual \[p.45\]](#) to learn how to do this.

## 1.4.7. Connect to AudioFuse Studio with Bluetooth

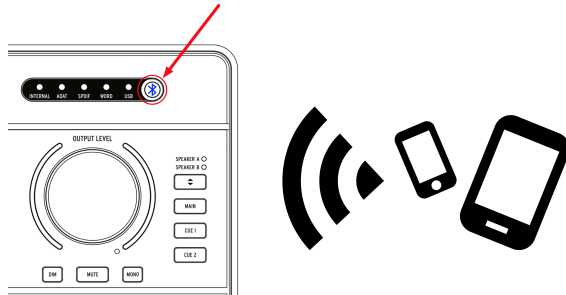

AudioFuse Studio has a built in Bluetooth receiver enabling a best in class Bluetooth audio experience. This is very useful because it allows users to wirelessly connect smartphones, tablets and computers with AudioFuse Studio and to stream music through the studio's speakers or to simply record the Bluetooth signal into your music software. Since AudioFuse Studio is a standalone device, the studio computer does not even need to be switched on to do this!

**i**!: Please note that only SBC, AAC, MP3 and aptx formats are supported by the AudioFuse Studio Bluetooth receiver. Other formats are not supported.

1: Press the Bluetooth button on the top panel of AudioFuse Studio. It is illuminated in blue when Bluetooth is active.

2: Connect to AudioFuse Studio from your smartphone, tablet or other device.

**i**!: The interface appears as 'AF\_STUDIO' followed by the serial number of your product. If you are not sure how to connect to a Bluetooth device, refer to your product's user guide.

3: Start playing music.

**i** You may need to configure your phone, tablet or other device to stream its output to the Bluetooth device instead of playing it from the built-in speaker. Again, please refer to your products user guide to learn how to do this.

### 1.4.8. Use AudioFuse Studio without a computer

AudioFuse Studio is a standalone product, meaning it can work without a computer as a mixer and monitor controller. To do this:

1. Connect your analog and digital devices to the inputs of AudioFuse Studio.
2. Connect the AudioFuse outputs to your speakers.
3. Connect the AudioFuse to the computer.
4. Launch AudioFuse Control Center and create up to three mixes (Main, Cue 1 and Cue 2) from the inputs.

Now you can unplug the computer and the AudioFuse Studio hardware will continue to mix your inputs even if a computer is no longer present. Your mix settings are saved in AudioFuse Studio so even if you switch off the interface, the settings will be remembered next time you restart the unit. All speaker and headphone related features (volume control, source select, mute, dim and mono modes) also continue to work, meaning there is quite a lot of functionality at your fingertips even if the computer is no longer present.

### 1.4.9. Using Phones 2 to Control Speaker B

AudioFuse Studio has the ability to route the second headphone output signal to the Speaker B output. Since the signal being routed is sourced after the headphone volume control knob, it means that you can use the second headphone's "Level" knob to control the loudness level of speaker B. This gives you independent volume control of Speaker Output A (via the Master Volume knob) and Speaker Output B (via the Phones 2 Level knob) thus having both speaker outputs A & B playing audio simultaneously with Phones 2 volume controlling the Speaker B's output level.

This option can be set in the AudioFuse Control Center. Please refer to that [software's User Manual \[p.45\]](#) to learn how to do this.

### 1.4.10. Loopback Mode

AudioFuse Studio includes two additional "loopback" input channels (USB channels 17-18) that are not accessed through the front or rear panels of the interface. They are connected to a dedicated USB record stream, so the output of any application on your computer can be "looped back" and recorded directly into your music software. This saves you from having to physically connect the outputs (the outputs of your application) to a pair of available inputs that your music software can then record.

### 1.4.11. Talkback on ADAT 1-2

AudioFuse Studio's Talkback microphone can be routed to its Speaker, Phones 1, Phones 2, ADAT Output 1-2 or any combination of these outputs through the AudioFuse Control Center application. Routing Talkback to ADAT 1-2 enables sending talkback to an external ADAT expander unit such as the AudioFuse 8Pre. In this case, if the AudioFuse 8Pre ADAT input 1-2 is routed to its headphone output, then the talkback is heard on headphone output of AudioFuse 8Pre. This can be very useful in scenarios where the AudioFuse 8Pre is set up in another room in the studio.

### 1.4.12. SPDIF Out from Speaker

By default, AudioFuse Studio's SPDIF output carries its own signal and is independent of the other outputs. However, AudioFuse Studio has the ability to set its SPDIF output to mirror the main speaker output after the master volume control knob. This is an extremely useful feature if you are using an external digital to analog converter or certain speakers that have SPDIF inputs. This can be set in the AudioFuse Control Center application. Refer to that [product's documentation \[p.45\]](#) to learn more.

### 1.4.13. AUX outputs from Inputs 1-4 (and DAW)

It is possible to route a variety of sources to the AUX outputs of AudioFuse Studio: Main mix, Cue 1, Cue 2, the direct output of your DAW and the direct input on channels 1-4. This is very useful as it allows you to record a live guitar "direct" through the AudioFuse instrument input while simultaneously sending the live analog signal off to a guitar amplifier that you can also record separately. This is something that can normally be done only with a costly DI box with a splitter.

Having the ability to do this means you can capture the sound of the guitar amp "as played" but also have a backup DI recording available in case you decide that you would like a different guitar tone. In this case, you can re-amp the DI recording using the instructions described earlier in this chapter.

## 1.5. An in-depth look at AudioFuse Studio

This chapter covers the inner workings of AudioFuse Studio. While the knowledge contained in this chapter is not strictly necessary for everyday use, we think technically minded users may find it interesting!

### 1.5.1. Input Paths in Detail

#### 1.5.1.1. Input Channels 1 - 4

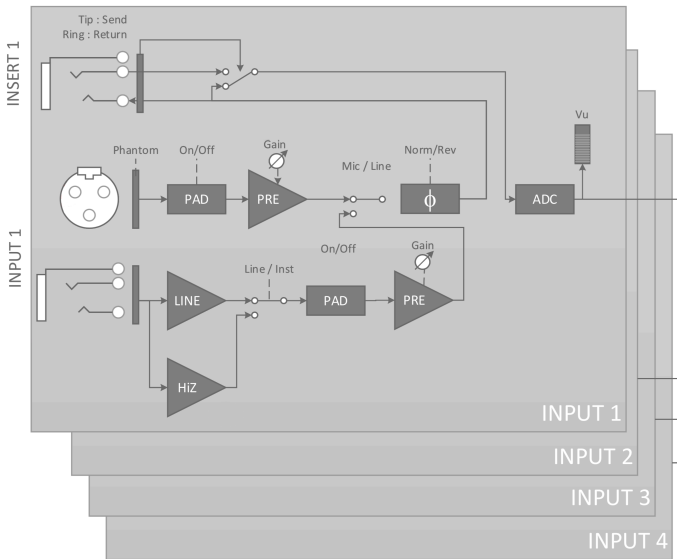

The functional block diagram above shows the complete input signal path of the four Input Channels of AudioFuse Studio. Notice that DiscretePro preamplifiers actually consist of two separate preamplifiers!

- The XLR input path is designed specifically to handle microphone signals with the highest fidelity.
- The 1/4" input path is similarly designed to handle Line and Instrument-level signals with the highest possible fidelity. This path is sub-divided into two different paths, one for standard line-level and the other for "hi-z" instrument level inputs (the *Inst* button on the front panel determines which path is selected).
- Each input path (Mic and Instrument) has its own dedicated Pad, and--as mentioned before--there are two separate high-end preamplifiers for each path to ensure the highest possible fidelity for each source.

The amplified signal is then sent through the (optional) phase-reversal circuit and sent on to the insert jack. If nothing is connected to the insert jack, the signal is automatically sent on to the analog-to-digital converter. If you do connect a device like a compressor or EQ to the insert jack, then the signal is "sent" to that device and "returned" to the analog-to-digital converter. You can learn how to do this in Chapter 4.

Finally, notice that VU metering happens after the analog-to-digital conversion. This ensures that you are monitoring the actual digital signal that is being sent to the computer. If there is any digital clipping taking place, you will be sure to see it here.



### 1.5.1.2. Inputs 5 - 6

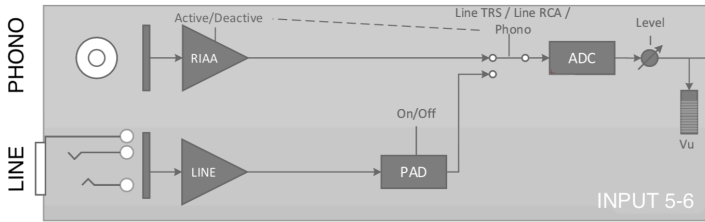

Inputs 5-6 on AudioFuse Studio can be used to bring in line-level signals (like from external synthesizers or external preamplifiers) or phono signals (turntables) through RIAA amplifiers specifically designed for turntables.



! You cannot use the Line and Phono inputs simultaneously.

Notice that these inputs (Line and Phono) have separate signal paths optimized for each kind of signal. You can select the active signal path through the AudioFuse Control Center application. Note that the line-level inputs have an optional 20 dB padding circuit that can be switched on and off through the AudioFuse Control Center application. Refer to that [software's documentation \[p.53\]](#) to learn more.

### 1.5.1.3. Inputs 7 - 8

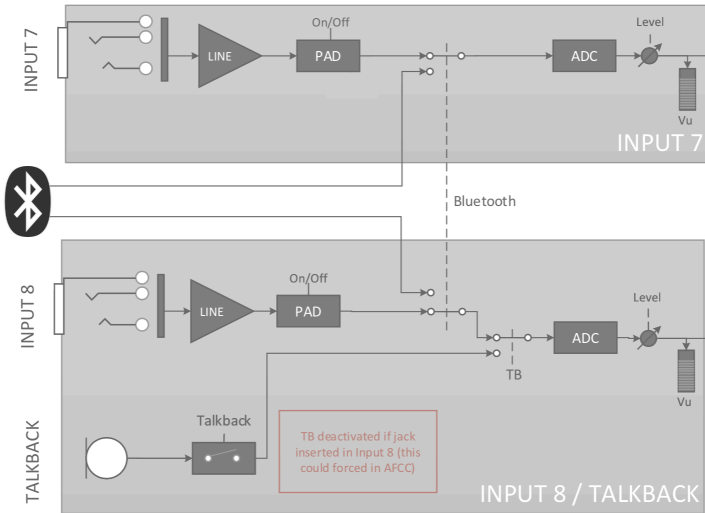

Inputs 7-8 can bring in line-level signals (just like channels 5-6 above) but can also bring in signals via AudioFuse Studio's Bluetooth receiver and the built-in talkback microphone. The AudioFuse Control Center application lets you set a variety of parameters including:

- The routing of the Bluetooth signal
- The optional 20 dB padding circuit for the line-level inputs
- The routing of the Talkback microphone

Refer to the [AudioFuse Control Center User Manual \[p.53\]](#) to learn more.

### 1.5.1.4. Digital inputs

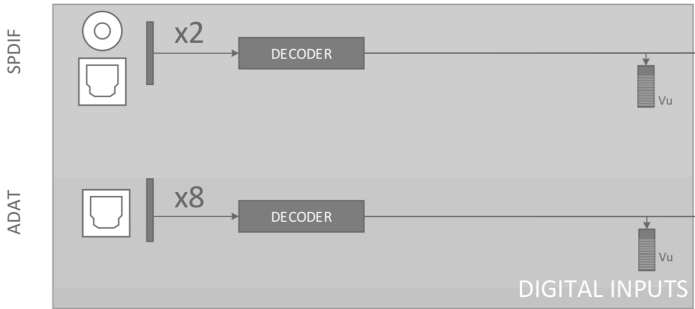

AudioFuse Studio provides up to 8 digital inputs through the ADAT protocol and another 2 digital inputs from S/PDIF.

The S/PDIF protocol comes in two varieties: Optical and Coaxial (RCA). AudioFuse Studio supports both variants and you can select which one you would like to use in the AudioFuse Control Center application. Please refer to that [software's User Manual \[p.29\]](#) to learn more.

## Digital Synchronization Possibilities

		Incoming Audio Source			
		SPDIF (Coax)	SPDIF (Optical)	ADAT 1	ADAT 2
Synchronization Type	Word Clock	--	--	Supported	Supported
	SPDIF (coax)	Supported	--	Supported	Supported
	SPDIF (optical) *	--	Supported	--	--
	ADAT 1	Supported	--	Supported	Supported
	ADAT 2 *	--	--	--	--

AudioFuse Studio can synchronize itself to external digital clock sources through many of the digital inputs on the back panel. This way, the interface can derive a clock source and drive its internal audio converters according to that source.

The table above lists incoming digital audio ports in columns along the top and the various methods of synchronization horizontally in rows. The word "Supported" is listed wherever it is possible to derive an external synchronization signal for AudioFuse Studio to use.

Notice that the synchronization signal does not necessarily have to be part of the incoming digital audio signal. For example, you can use the coaxial SPDIF connector to receive a master clock source while the actual audio signals come in through the ADAT 1 and 2 inputs. This kind of flexibility can be very handy in professional environments with many digital devices requiring a complex synchronization scheme.

**i**!: When the synchronization signal is not part of the incoming digital audio signal, it is strongly recommended to make sure the external devices are synced to the same synchronization source.

- The SPDIF (optical) and ADAT 2 inputs share the same optical port on the back panel of AudioFuse Studio. You can determine whether this port acts as a SPDIF or ADAT connector using the Audio Fuse Control Center application. Please refer to the [AFCC User Manual \[p.45\]](#) to learn how to do this. Note that this port cannot be used to synchronize ADAT signals (only ADAT 1 can transfer ADAT clock).

## 1.5.2. Monitor Mixing and Routing

AudioFuse Studio offers three powerful low latency "monitor mixers" inside itself called: *Main*, *Cue 1* and *Cue 2*. These three stereo mixers can be freely dialed in and routed to the speakers (*Speaker A* or *Speaker B*) or headphones (*Cue 1* or *Cue 2*) to provide a near-zero latency mix.

## 1.5.3. Creating a Monitor Mix

The *Main*, *Cue 1* and *Cue 2* mixes are created using the AudioFuse Control Center software. They can be created using any of the analog or digital inputs of AudioFuse Studio as well as up to six "software return" outputs of your music software. Please refer to the [AudioFuse Control Center User Manual \[p.55\]](#) to learn how to create or modify monitor mixes.

## 1.5.4. Routing Monitor Mixes to speakers and headphones

Once you have created a monitor mix, you have a great deal of flexibility in routing that mix to various destinations. For example, you can listen to the *Main Mix* on your speakers while two different vocalists receive their own custom mix (*Cue 1* and *Cue 2*) in their headphones. If desired, you can quickly switch the source of the speakers to *Cue 1* or *Cue 2* to hear what your vocalists are hearing and then switch back. This is done using the Source Select buttons on the top panel of AudioFuse Studio. The Source Select buttons and other top panel controls are covered in Chapter 2 of this guide.

## 1.5.5. USB Audio mapping

AudioFuse Studio displays differing numbers of input and output channels in your music software depending on your selected sampling rate.

Sampling Rate	Inputs	Outputs
44.1 / 48 kHz	20	18
88.2 / 96 kHz	18	18
176.4 / 192 kHz	10	10

The tables below contain detailed information about inputs and outputs at each sampling rate.

### 1.5.5.1. Audio Mapping at 44.1 / 48 kHz sampling rates:

Input	Computer Input (REC)	Computer Output (Playback)
1	Input Channel 1	Main Left
2	Input Channel 2	Main Right
3	Input Channel 3	Cue 1 Left
4	Input Channel 4	Cue 1 Right
5	Line Input 5 / Phono (Input 5)	Cue 2 Left
6	Line Input 6 / Phono (Input 6)	Cue 2 Right
7	Line Input 7	Aux Out Left
8	Line Input 8 / Talkback	Aux Out Right
9	S/PDIF Left	S/PDIF Left
10	S/PDIF Right	S/PDIF Right
11	ADAT 1	ADAT 1
12	ADAT 2	ADAT 2
13	ADAT 3	ADAT 3
14	ADAT 4	ADAT 4
15	ADAT 5	ADAT 5
16	ADAT 6	ADAT 6
17	ADAT 7	ADAT 7
18	ADAT 8	ADAT 8
19	Loopback Left	-
20	Loopback Right	-

### 1.5.5.2. Audio Mapping at 88.2 / 96 kHz sampling rates:

Input	Computer Input (REC)	Computer Output (Playback)
1	Input Channel 1	Main Left
2	Input Channel 2	Main Right
3	Input Channel 3	Cue 1 Left
4	Input Channel 4	Cue 1 Right
5	Line Input 5 / Phono (Input 5)	Cue 2 Left
6	Line Input 6 / Phono (Input 6)	Cue 2 Right
7	Line Input 7	Aux Out Left
8	Line Input 8 / Talkback	Aux Out Right
9	S/PDIF Left	S/PDIF Left
10	S/PDIF Right	S/PDIF Right
11	ADAT 1	ADAT 1
12	ADAT 2	ADAT 2
13	ADAT 3	ADAT 3
14	ADAT 4	ADAT 4
15	ADAT 5	ADAT 5
16	ADAT 6	ADAT 6
17	ADAT 7	ADAT 7
18	ADAT 8	ADAT 8

### 1.5.5.3. Audio Mapping at 176.4 / 192 kHz sampling rates:

Input	Computer Input (REC)	Computer Output (Playback)
1	Input Channel 1	Main Left
2	Input Channel 2	Main Right
3	Input Channel 3	Cue 1 Left
4	Input Channel 4	Cue 1 Right
5	Line Input 5 / Phono (Input 5)	Cue 2 Left
6	Line Input 6 / Phono (Input 6)	Cue 2 Right
7	Line Input 7	Aux Out Left
8	Line Input 8	Aux Out Right
9	S/PDIF Left	S/PDIF Left
10	S/PDIF Right	S/PDIF Right

## 1.5.6. Clock Synchronization

Digital audio devices need to be synchronized to one master clock in order to exchange audio data properly. AudioFuse Studio can run on its own internal clock or it can synchronize itself to external clock sources.

The (default) internal clock of AudioFuse Studio is extremely stable and will offer you the best performance in most situations. If you have the option to drive your peripheral gear from AudioFuse Studio's internal clock, please do so. However, if you do need to have another device to function as the master clock and to have AudioFuse Studio synchronize itself to that device's clock, you can do so through the AudioFuse Control Center software. Please refer to the [AudioFuse Control Center User Manual \[p.45\]](#) to learn how to do this.

### 1.5.6.1. Using the Internal Clock

The internal clock of the AudioFuse can operate at the following sampling rates:

- 44.1 kHz
- 48 kHz
- 88.2 kHz
- 96 kHz
- 176.4 kHz
- 192 kHz

The sampling rate can be set from AudioFuse Control Center, your computer's audio control panel or your music software depending of the computer's operating system.

If the AudioFuse Studio is set to use its internal clock, it can function as a master clock for other external devices. When using its internal clock source, AudioFuse Studio will automatically deliver digital master clock over its outputs depending on how you have configured the digital IO settings: - If Word Clock is selected: The interface delivers Word Clock on coax, and ADAT clock on ADAT 1 - If SPDIF and Coax are selected: The interface SPDIF clock on coax out, and ADAT clock on ADAT 1 - If SPDIF and Optical are selected: The interface only delivers SPDIF clock on ADAT 2 connector

When AudioFuse Studio is synchronized to an external clock source, it still can deliver digital audio clock as shown:

SPDIF type	Standard (Coax)						Optical	
	SPDIF			Word			-	
Digital Coax Format	Internal	SPDIF	ADAT	Internal	Word	ADAT	Internal	Optical SPDIF
Clock Source		SPDIF	(SPDIF)		Word	(Word)		-
Digital Audio Input Coax		SPDIF	(SPDIF)		Word	(Word)		-
Digital Input Optical		(ADAT)	ADAT		(ADAT)	ADAT		Optical SPDIF
Digital Output Coax	SPDIF	SPDIF	SPDIF	Word	Word	Word		-
Digital Outputs Optical	ADAT	ADAT	ADAT	ADAT	ADAT	ADAT	Optical SPDIF	Optical SPDIF

- Sync on Word Clock : deliver ADAT & Word Clock
- Sync SPDIF coax : deliver SPDIF & ADAT clock
- Sync SPDIF optical : deliver only SPDIF opt clock
- Sync ADAT : Deliver ADAT clock & Spdif or Word depending of Word/SPDIF selection

### 1.5.6.2. Using External Clock Sources

If you must use an external device to function as the master clock, you can set AudioFuse Studio to synchronize itself to that device. AudioFuse Studio is quite flexible and can synchronize to signals coming from any of its digital inputs:

- Word Clock - using the *WCLK / S/PDIF* RCA input on the rear panel

**i**!: When using the Word Clock input and synchronizing AudioFuse Studio to external sources, you will need to “terminate” the input if AudioFuse Studio is the last device in your chain. The AudioFuse Studio hardware supports this and you can switch on 75 OHM termination from the Audio Fuse Control Center application. Note that when using AudioFuse Studio as the word clock *master*, you do not need to set the Word Clock Termination parameter. Please refer to the [“Digital Coax Termination” \[p.45\]](#) section of the AFCC User Manual to learn how to do this.

- S/PDIF Coax - using the *WCLK / S/PDIF* RCA input on the rear panel
- S/PDIF Optical - using the SPDIF (ADAT 5-8) optical connector
- ADAT - using the ADAT 1-8 (1-4) optical connector

**i**!: The maximum supported sample rate for ADAT clocking is 96kHz.



## 1.6. Specifications

- 18 inputs, 20 outputs channels
- 4 mic/instrument/line preamps with DiscretePRO® technology
- 4 additional line inputs, with inputs 5-6 commutable to Phono
- 4 analog inserts on channel 1-4
- Bluetooth stereo audio receiver supporting aptX® and AAC®
- 2 pairs of speaker analog outputs on balanced TRS Jack
- 2 independent stereo headphones outputs, on both 6.35 and 3.5mm TRS.
- 2 independent analog line outputs with reamp capability (instrument impedance output)
- Complete monitoring section with individual level control for speakers and phones
- Direct monitoring ultra-low latency internal mixers
- 8 digital ADAT inputs/outputs up to 96kHz
- S/PDIF inputs/outputs or Word clock input, output/thru on Cinch RCA
- Integrated Talkback feature with a dedicated built-in microphone
- MIDI In & Out
- 3-port USB hub (with two 1A ports for rapid charging)
- DiscretePRO® Individual audio performance certificate delivered with each unit.
- 24-bit latest generation AD/DA converters at up to 192kHz sampling rate.
- USB-C interface compatible with PC & Mac, fully USB 2.0 compatible
- Comes with AudioFuse Creative Suite
- Robust metal desktop chassis

Line Inputs	
Input Impedance	20k $\Omega$ (symmetric), 10k $\Omega$ (asymmetric)
Maximum Input Level	+24dBu
Gain Range	45dB typical
Pad Mode	-20dB
Frequency Response 20Hz/20kHz	+/-0.01dB typical
Dynamic Range	119dB (A-weighted)
THD+N	-112dB (A-weighted)

Instrument Inputs	
Input Impedance	1.1M $\Omega$ (asymmetric)
Maximum Input Level	+18dBu
Gain Range	45dB typical
Pad Mode	-20dB
Frequency Response 20Hz/20kHz	+/-0.01dB typical
Dynamic Range	119dB (A-weighted)
THD+N	-112dB (A-weighted)

<b>Line Aux Inputs</b>	
Input Impedance	20k $\Omega$ (symmetric), 10k $\Omega$ (asymmetric)
Maximum Input Level	+24dBu
Pad Mode	-20dB
Frequency Response 20Hz/20kHz	+/-0.02dB typical
Dynamic Range	120dB (A-weighted)
THD+N	-108dB (A-weighted)

<b>Microphone Preamps</b>	
Input Impedance	3.4k $\Omega$
Maximum input level	+11dBu
Gain range	71dB typical
Boost mode	+10dB
Pad mode	-20dB
Frequency response 20Hz to 20kHz	+/-0.09dB
Equivalent Input Noise (EIN)	-129dB typical (un-weighted)
THD+N @ 1kHz	-107dB (A-weighted)
Dynamic range	118dB (A-weighted)

<b>Input Inserts</b>	
Output Impedance	240 $\Omega$ balanced, 120 $\Omega$ unbalanced
Input Impedance	20k $\Omega$ (balanced), 10k $\Omega$ (unbalanced)

<b>Aux / Line / Speaker Outputs</b>	
Output Impedance	240 $\Omega$ balanced, 120 $\Omega$ unbalanced
Maximum Output Level	+24dBu
Dynamic Range	121dB (A-weighted)
THD+N	-108dB (A-weighted)
Frequency response 20-20kHz	+/-0.07dB

<b>Phones Outputs</b>	
Output Impedance	10Ω on 6.35mm TRS 33Ω on 3.5mm TRS
Maximum Output Level	+13dBu on 6.35mm TRS +10dBu on 3.5mm TRS
Dynamic Range	103dB (A-weighted)
THD+N @ 1kHz	-92dB (A-weighted)
Power @ 33ohm @1%THD	60mW on 6.35mm TRS 22mW on 3.5mm TRS

<b>Talkback Microphone</b>	
Max input Level (@440Hz)	95dB SPL
Dynamic range	55dB
Audio bandwidth	120Hz - 8kHz

<b>Clocks</b>	
Supported Frequency Rates	44.1 kHz, 48 kHz, 88.2 kHz, 96 kHz, 176.4 kHz, 192 kHz

## 2. AUDIOFUSE CONTROL CENTER

### 2.1. Welcome to AudioFuse Control Center!

Arturia has a long history of developing highly sought-after hardware products, while also crafting supplementary software that enhances the capabilities of the hardware many times over.

The AudioFuse Control Center (AFCC) is software that was specifically designed to complement the already impressive series of AudioFuse interfaces. It provides access to features that are not available directly on the physical units, in addition to the features that are. The AFCC runs on Windows and macOS systems.

These feature-packed devices, combined with the power and flexibility of the AudioFuse Control Center, will help you capture and control any musical magic that you can imagine.

#### Features of AudioFuse Control Center

- Control most of the front-panel features of your AudioFuse device remotely
- Configure hidden parameters such as Digital Coax Termination and other device-specific features
- Visual representation of signal routing, input/output levels, channel status, etc.
- View device settings such as sample rate, sync lock
- Quick selection between multiple AudioFuse devices
- Notifies you of firmware upgrades
- Window size can be optimized for your display monitor
- Runs on Windows and macOS systems

### 2.2. Overview

#### 2.2.1. The Main window

In keeping with the "everything you need at your fingertips" design of the AudioFuse series, there is one main window for the AudioFuse Control Center (AFCC). Other than the basic setup options found in the Menu bar, everything the selected unit can do is right before your eyes; there are no additional menus or alternate pages. And if you have more than one unit attached to your computer you can switch back and forth between them easily.

##### 2.2.1.1. Two-way communication

You'll love the way your AudioFuse device interacts with its Control Center software: when you push a button on the unit, the equivalent control inside the AFCC will do the same thing. The buttons work both ways: they light up when pressed on the unit or clicked in the software.

Most of the physical knobs are analog controls, so they do not have an equivalent control in the AFCC. The only exceptions are the big Output Level knobs on the AudioFuse and AudioFuse Studio; when those are moved, the value changes in the AFCC and the equivalent control will move in the AFCC. (For the AudioFuse it's the big Output Level knob; for the AudioFuse Studio it's the Speakers fader in the Analog Outputs section). The physical knob won't move when the AFCC control is moved, though.

### 2.2.1.2. Basic operations

It's obvious how to use some features, like pushing a button, selecting a menu, or moving a knob or slider. But there are some other great features and operational tips we should mention as you are beginning to learn to use the AFCC.

## Tool tips



The AFCC window displays values of the controls as they are being edited. You can also hover over a control with the cursor if you'd like to see its current value before you edit it. A quick description of the functions and controls can also be displayed in the bottom status bar of the AFCC.

## Reset Parameters to Default

We've made it easy to return a parameter to its default value, such as re-centering the pan value for a channel, etc. To do this, either double-click the related control or use a combination of Option + Click (macOS) or Alt + Click (Windows).

## Fine adjustments (0.1 dB increments)

Some parameters have a very wide range, such as the level faders or the pan knobs. You can move these controls quickly to get close to the value you want, and then fine-tune the value by doing the following:

- macOS: Right click + drag the cursor, or hold Ctrl + drag the cursor.
- Windows: Right click + drag the cursor, or hold Ctrl + drag the cursor.

## 2.2.2. The AudioFuse Studio window

This window has three main sub-sections. You'll always see the same basic items in the top and bottom sections. The middle window is the one that can change its appearance the most, depending on the Monitor mix you want to have available. It also can be hidden and revealed as needed to help maximize your screen space.



The AudioFuse Control Center interface

Section	Name	Function
1	<a href="#">Input zone [p.53]</a>	Displays input types, button options, and LED level meters
2	<a href="#">Monitoring Mix [p.55]</a>	Shows Cue Mix components, controls levels, pan, and solo/mute status, and allows adding, removing, naming and grouping of channels
3	<a href="#">Output zone [p.59]</a>	Displays input/output assignments, allows editing of input assignments, provides source selection for Loopback feature, and has LED level meters

### 2.2.2.1. AudioFuse Studio controls not in AFCC

Most of the AudioFuse Studio buttons are linked to a button in the AFCC, except for the Listen and Talkback buttons. As the physical button is pressed the virtual button will toggle, either in the Analog Inputs section or the Analog Outputs section.

The following AudioFuse Studio controls are analog and do not communicate their actions to the computer. As a result they have no equivalent control in the AFCC:

Control	Function
Gain 1-4	Use the physical knobs to set the level for the analog input channels.
Listen	Press to isolate the selected signal at the selected output. Routing options are set in the AFCC.
Phones	Provides level control for the selected headphone output.
Talkback	Press the button to activate the built-in microphone. Routing options are set in the AFCC.



ⓘ: The Listen and Talkback buttons are not part of the AFCC main window, but their behavior can be defined inside the Audio Settings tab of the [Device Settings window](#) [p.45].

## 2.3. The Menu bar

The strip along the top of the AudioFuse Control Center is called the Menu bar. Its contents may vary depending on which device you have selected.

### 2.3.1. The Arturia menu

Click the upper left-hand corner of the AFCC window to open the Arturia menu.



#### 2.3.1.1. Resize Window



The AFCC automatically detects the size of your monitor and selects the optimal magnification value. But you can override this setting and it will be remembered the next time you launch the AFCC.



### 2.3.1.2. AFCC Manual

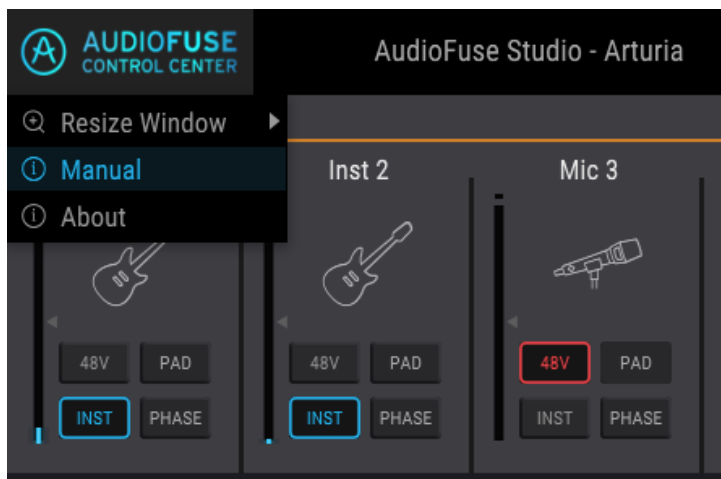

The AFCC has a built-in Help file (this manual). To open it, select the word "Manual" from the drop-down menu.

### 2.3.1.3. About

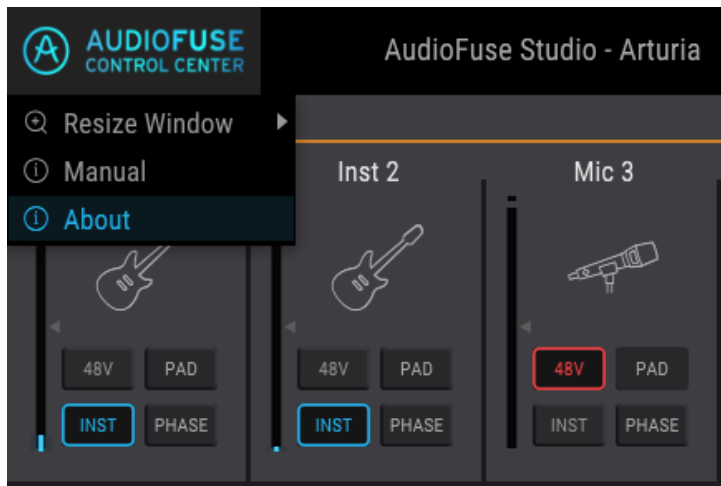

This menu item provides information about the AudioFuse Control Center. It lists the engineering credits and displays the current version of the software you have installed.

### 2.3.2. Device Selection



This window allows you to select between devices when more than one AudioFuse product is connected to the same computer. That way you can choose which one you want to modify with the AFCC.

### 2.3.3. Device Status



The Menu bar has two fields that show you the status of the AudioFuse Studio at a glance.

- **Sample Rate** displays the sample rate being generated or received.
- **Clock Source** indicates the sync selection: Internal, WORD, or ADAT Clock.

To change these settings, navigate to Device Settings > Audio Settings.

## 2.3.4. Device Settings

Click the gear-shaped icon in the upper right corner of the Menu bar to open the Device Settings window. It has three tabs which contain the audio settings, preferences, and firmware update information for the AudioFuse Studio.

### 2.3.4.1. Audio Settings

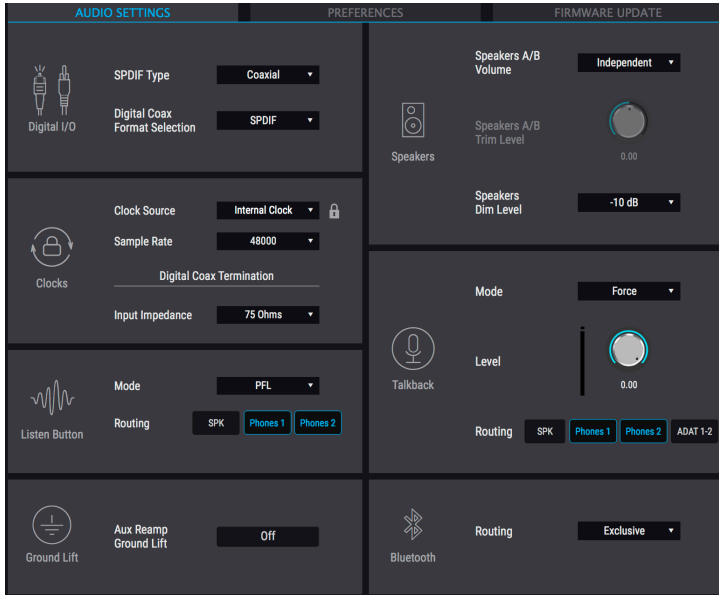

The Audio Settings tab is where the basic operational settings for the AudioFuse Studio are located. We'll describe each one in the following paragraphs.

## Digital I/O

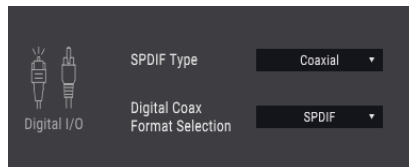

The AudioFuse Studio rear panel offers several ways to send and receive digital audio. This AFCC window determines how the unit will handle SPDIF data. Two parameters are shown:

- **SPDIF Type** options are Coaxial and Optical. The **Coaxial** setting sends and receives SPDIF data at the WCLK | S/PDIF In/Out RCA connectors. The **Optical** setting sends and receives SPDIF data at the Optical In/Out S/PDIF ports (also labeled ADAT 5-8).
- **Digital Coax Format Selection** options are SPDIF and Word. **SPDIF** sends and receives SPDIF data at the WCLK | S/PDIF In/Out RCA connectors. The **Word** setting means that the WCLK | S/PDIF connectors will send and receive Word clock signals only.



The Digital Coax Format Selection is not accessible when the SPDIF Type is set to Optical.

The following chart presents this information in another way that may be helpful.

SPDIF type	Standard (Coax)						Optical	
Digital Coax Format	SPDIF			Word			-	
Clock Source	Internal	SPDIF	ADAT	Internal	Word	ADAT	Internal	Optical SPDIF
Digital Audio Input Coax		SPDIF	(SPDIF) [1]		Word	(Word) [1]		-
Digital Input Optical		(ADAT) [2]	ADAT		(ADAT) [2]	ADAT		Optical SPDIF
Digital Output Coax	SPDIF	SPDIF	SPDIF	Word	Word	Word		-
Digital Outputs Optical	ADAT	ADAT	ADAT	ADAT	ADAT	ADAT	Optical SPDIF	Optical SPDIF

[1] = Specified format can be received if incoming sample rate matches the Clock Source selection [2] = ADAT audio can be sent at a sample rate that matches the Clock Source selection n/a = not available or not applicable

## Clocks

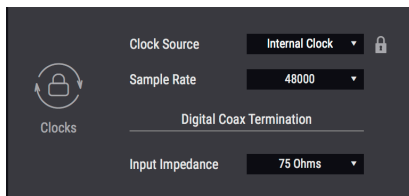

## Clock Source

This field determines whether the AudioFuse Studio operates according to its internal clock or synchronizes to an external clock source. There are four options: Internal, ADAT, S/PDIF, or Word Clock.

A small Lock icon indicates if the unit's clock is locked to the desired clock source. If Orange, the desired clock source is invalid.

## Sample Rate

If the Clock Source of the AudioFuse Studio is set to Internal, you can use this field to select the Sample Rate at which the unit will operate. If the Clock Source is set to one of the external source options, this field is greyed out and cannot be altered here. The sample rate that is shown will match the sample rate of the master device.



In macOS the Sample Rate can be changed using Audio MIDI Setup or within your DAW project.

## Digital Coax Termination

If the AudioFuse Studio will be the Word Clock master for your system then you don't need to set the Digital Coax Termination parameter. But if you plan to slave the unit to Word Clock, then this parameter is important.

There are two settings for the Digital Coax Termination parameter: 75 Ohm and Hi-Z. Which one to use depends on whether the unit is last in the Word Clock chain or somewhere in the middle. In case the AudioFuse Studio is the last device in the WordClock chain, please set the Input Impedance parameter to 75 Ohms to terminate the clock chain. If another unit is connected to the AudioFuse Studio WordClock output, please select HiZ.

## Listen Button

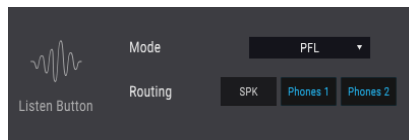

Each of the first four input channels on the AudioFuse Studio has a Listen button. This AFCC window determines how they respond when pressed.

- **Mode** options are PFL (Pre-fader level) and Solo. PFL allows you to hear the direct signal coming into the input, regardless of the fader setting in the AFCC Monitoring Mix section. Solo activates the Solo button for that channel in the Monitoring Mix and sets the level according to the Monitoring Mix fader. The signal for that input will be heard when the Listen button is pressed.
- **Routing** offers three destinations for the audio depending of the selected Mode.



Be careful! If any live microphones are in the same room with the speakers when the SPK option is selected, you could experience LOUD feedback through your speakers as the soloed signal is picked up by the mics, routed through the speakers, picked up by the mics again, etc.

## Ground Lift

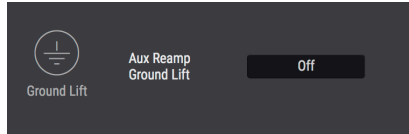

This parameter could be handy when using the Re-Amp feature. If you hear a ground hum when the AudioFuse Studio is connected to a guitar amplifier, try setting the Aux Out Ground Lift parameter to On.

**i** The Ground Lift is only activated when one or both of the Aux Out Re-Amp circuits is activated, even when this parameter is set to On. In other words, if the Re-Amp feature is not being used, the Ground Lift will not be activated.

## Speakers

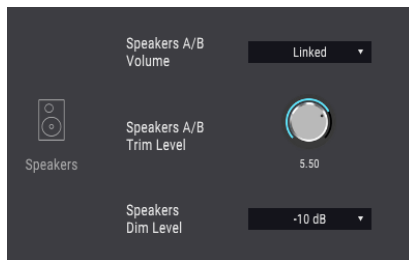

### Speakers A/B Volume

It is possible to link the output levels of Speaker A and Speaker B. If you prefer not to have them linked, choose the Independent setting.

### Speakers A/B Trim Level

Some monitor speakers may have input characteristics that cause them to clip the audio sooner than other monitor speakers do. Conversely, some monitor speakers may be able to withstand a hotter input. This allows you to offset their output levels to compensate for this, using the Speakers A level as a reference point and then applying the offset to the Speakers B level.

The value can be altered in a positive or negative direction; just click and drag the knob up or down until the proper ratio is achieved. The range is -12 dB to +12 dB.

Hold the Control key and click/drag for more precise control of this parameter. Double-click the knob to reset the value to 0 dB.

### Speakers Dim Level

This menu sets the amount of level reduction that occurs at all stereo outputs when the Dim button is pressed. The Dim level is also applied when the Talkback feature is engaged.

## Talkback

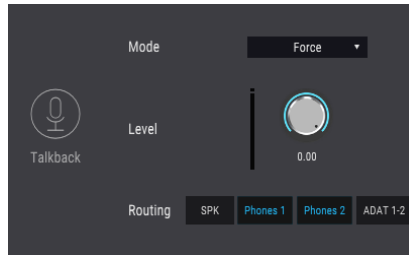

The Talkback button activates the built-in microphone of the AudioFuse Studio. This AFCC window determines how the Talkback audio is processed.

- **Mode** The Talkback feature shares the same input as line input 8, so the AFCC offers two Modes that let you specify what the Talkback feature can do when something is plugged into input 8.
  - **Auto:** if something is plugged into input 8, then the Talkback feature can not be activated
  - **Force:** the Talkback feature can be activated even if something is plugged into input 8.
- Use the **Level** knob to adjust the level of the built-in Talkback microphone.
- The **Routing** button allows you to route the Talkback output to the Speakers (SPK), Phones 1, Phones 2, or ADAT outputs 1 and 2. All four can be active if you like. The ADAT 1-2 button provides an added benefit, in that it routes the Talkback audio to an ADAT-equipped device such as the AudioFuse 8Pre. The AudioFuse 8Pre then routes the Talkback audio to its headphone outputs, further integrating your studio and enhancing your productivity.



**i**: Be careful! If any live microphones are in the same room with the speakers when the SPK option is selected, you could experience LOUD feedback through your speakers as the soloed signal is picked up by the mics, routed through the speakers, picked up by the mics again, etc.

## Bluetooth

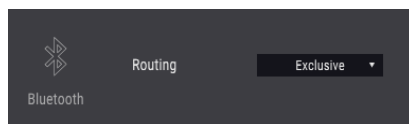

This parameter determines what happens to the incoming audio after the AudioFuse Studio has been paired with a Bluetooth device:

- **Exclusive:** this setting routes the Bluetooth channels to all monitoring outputs (Speaker and Phones). With this setting only the Bluetooth audio will be heard on the monitoring outputs.
- **Input Channels 7/8:** the Bluetooth signal is handled the same as any other stereo pair of input channels. The channels are hard-panned to the left and right.

Setting this parameter to Input Channels 7/8 makes it possible to route audio from a Bluetooth device to a stereo channel in your DAW. Recordings or tracks you've made on your mobile device can now become part of your session and part of your song.

### 2.3.4.2. Preferences

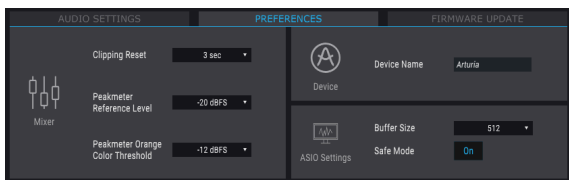

The ASIO settings are described below; please refer to the following sections for information about Clipping Reset, Peak Meter Reference Level, Peak Meter Orange Color Threshold and Device Name.

#### Clipping Reset

You can select the amount of time it will take for the AFCC Clip LEDs to reset after they have been triggered. There are four options:

- **None:** the LEDs will reset immediately.
- **Infinite:** the LEDs will stay lit indefinitely unless reset manually using the AFCC.
- **1.5 sec:** the LEDs will stay lit for a brief moment (1.5 seconds) and then reset.
- **3 sec:** the LEDs will stay lit for a bit longer (3 seconds) and then reset.

#### The Peak Meter Reference Level

The Peak Meter Reference Level is a simple way to indicate the reference level used in the studio (i.e., the "working level", which is usually -18dBFS for a 1kHz sine). This is a quick, easy way to check your levels against this calibration, and you can choose the preferred calibration level within a range of -12 dBFS to -20 dBFS.

#### The Peak Meter Orange Color Threshold

This parameter sets the lowest level at which the first orange LED will activate for the Input Channel meters and the Output Level meters.

#### Device Name

Click in this field to personalize the name of your AudioFuse.



## Windows: ASIO Settings



The Preferences window for macOS does not have the ASIO Settings options.

These two parameters have a significant impact on the integrity of the audio that passes through the AudioFuse Studio.

- **Buffer Size:** The Arturia USB Audio driver automatically selects the optimal buffer size each time the sample rate changes. You can select a different value, but the AFCC won't allow a buffer size that is not compatible with the current sample rate. A warning message will inform you of incompatible settings.
- **Safe Mode:** Set Safe Mode to **On** to ensure the integrity of the audio samples. However, this also places a higher load on the CPU. If you disable this feature, latency will decrease slightly but the risk of dropped samples will increase. **Disabling Safe Mode is not recommended**, unless you work on a particularly powerful PC with only a few tracks.

## 2.3.5. Firmware Updates

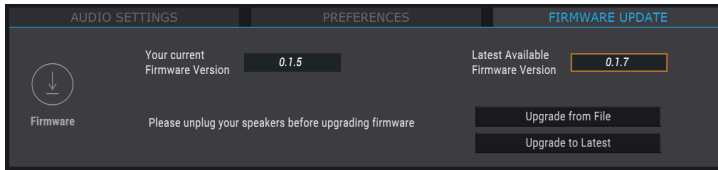

The AFCC will let you know when a new version of the firmware for your device becomes available. This is the page you will use for the update process. Once the file has been downloaded to your computer, click "Upgrade from File" to navigate to the file location. Select the file with the proper extension (.bin for AudioFuse, .afstudio for the AudioFuse Studio, .af8pre for the AudioFuse 8Pre) and follow the instructions.

When updating the firmware for any AudioFuse device, the unit must be powered by both connectors (USB and DC).

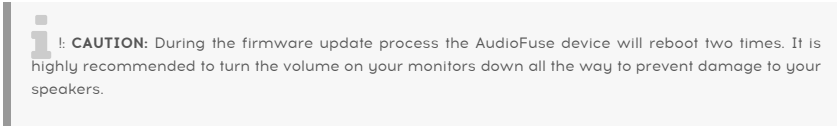

During the upgrade process you will be shown a progress bar that indicates how far along in the process the unit is.

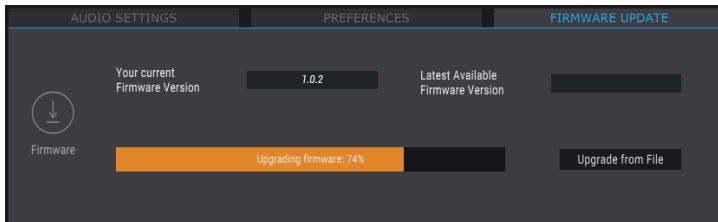

*The firmware upgrade in progress*

You'll know the upgrade is complete when the progress bar is replaced with the word "Success":

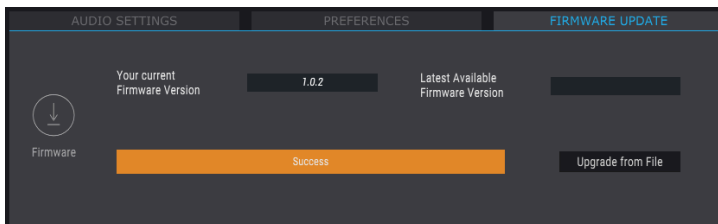

## 2.4. The Main Window

Beneath its deceptively simple exterior, the AudioFuse Studio provides an astounding array of features. The AudioFuse Control Center is the key to unlocking their full potential.

### 2.4.1. Input zone



Spanning the width of the AFCC window beneath the Menu bar is the Input zone. It provides a visual summary of the analog signals being fed into the AudioFuse Studio, along with meters that display the signals that are arriving at the ADAT and SPDIF inputs.

#### 2.4.1.1. Analog Inputs

In the expanded view this section shows the status and signal levels of the analog connectors on the front and rear panels of the AudioFuse Studio. It has:

- buttons that match those on input channels 1-4, which can toggle (and be toggled by) their physical counterparts
- buttons and knobs that link and control the levels of inputs 5-8, and menus that specify the connection type
- LED meters that display the signal level of each input
- icons that represent the type of input device being used.

The icon for an unused input channel looks like one of the combo jacks on the AudioFuse Studio. When you plug something in, the icons change to match the type of connection that has been made.

For example, plug in an XLR connector and the icon becomes a microphone on a stand; make a 1/4" connection and the icon becomes a 1/4" plug. When the INST button is activated for inputs 1-14, the 1/4" plug icon becomes a guitar.

You'll notice that some buttons are greyed out when you use certain types of inputs. For example, when you plug in a 1/4" cable the AudioFuse Studio knows you will not need phantom power for that device, so the 48V button is deactivated.

The following table lists the buttons that can be used with each input type.

Analog input #	Button name	Visible for input type:	Possible settings
1-4	48V	Microphone	On (lit red), Off
1-4	PAD	Microphone Line, Instrument	Off, PAD (-20dB), BOOST (+10dB) Off, PAD (-20dB)
1-4	INST	Line, Instrument	On (lit blue), Off
1-4	PHASE	Microphone, Line, Instrument	On (lit blue), Off
5-8	LINK	Line RCA, Phono	On (lit blue), Off
7-8	PAD	Line, Instrument	Off, PAD (-20dB)



The icons do not change when an insert connection is used for input channels 1-4.

## Inputs 5-8: Menu options

Input pairs 5-6 and 7-8 have drop-down menus that specify the type of device that is connected.

For Inputs 5-6 the options are Line TRS, Line RCA, and Phono. Connect a device to the 1/4" jacks or the RCA jacks (not both) and then select one of the following:

- **Line TRS:** Use this with a balanced or unbalanced line-level input such as a keyboard, drum machine, etc.
- **Line RCA:** Use this with a consumer line-level input such as the output of a CD player, etc. (-10dBV).
- **Phono** is for use with a turntable. Be sure to use the GND connector on the rear panel of the AudioFuse Studio when connecting a turntable. See the documentation for those devices to determine the optimal connection method.

For Inputs 7-8 the choices are TRS Line or Bluetooth.

- **TRS Line:** Use this setting to connect a line-level input such as a keyboard, drum machine, etc.
- **Bluetooth:** Use this when pairing the AudioFuse Studio with a Bluetooth device.



If you're using a pre-amp for your instrument, such as the output of an effects unit, you may be able to use the Line setting instead.

### 2.4.1.2. Digital Inputs

This section only has LED level meters. They display the signal levels for each of the incoming ADAT tracks and the SPDIF input. There are no other functions available; what they get is what you see. When no valid incoming digital signals are detected, the Digital Inputs label and icon are greyed.

## 2.4.2. Monitoring Mix zone

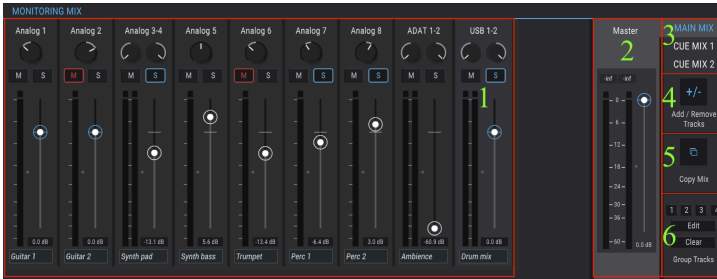

Section	Name	Function
1	Channel display	Adjust level, pan, Solo / Mute status of Monitoring Mix channels
2	Master level fader & meter	Adjust overall level of selected Mix, numerical readout of peak levels
3	Mix selection tabs	Select Main Mix, Cue Mix 1, or Cue Mix 2
4	Add / Remove Tracks	Define contents of selected Mix
5	Copy Mix	Click to copy selected Mix, then select the target Mix tab
6	Group Tracks	Link specific Mix channels for simultaneous edits

At the center of the AFCC window is the Monitoring Mix zone. Its function is to define the Monitoring Mixes: Main Mix, Cue Mix 1, and Cue Mix 2. Any one of these mixes can be adjusted independently and sent to any of the unit's outputs.

Each of the six sub-sections will be described in order.

### 2.4.2.1. The Channel display

This section occupies the majority of the Monitoring Mix zone. Which channels you will see here depends on what you want the selected Monitoring Mix to contain. For example, it might have only a few Analog inputs, a half-dozen ADAT tracks, and one or more sources arriving over USB from your DAW. You can make these selections using the [Add / Remove Tracks feature](#) [p.56].

Use the individual faders of each mono or stereo input channel to set their levels. This will affect the selected Monitoring Mix only, not what is sent to the DAW input channels.

## Naming Channels

To name a channel, click in the name field below the channel fader and type the desired name. If no name is entered the default name for that channel will be used: Analog 1-2, ADAT 3, USB 5-6, etc.

### 2.4.2.2. The Master level fader

Just like the master fader on a physical mixing console controls the combined output of all of the audio passing through the console, the Master level fader of the AFCC allows you to raise or lower the combined output of all of the input channels in the Channel display before it is sent to the selected output. As with the individual channel levels in the Channel display, the Master fader will affect the selected Monitoring Mix only, not what is sent to the DAW input channels.

## Master peak value

The small window above the fader shows the peak levels that occur during playback. Double-click the value field to reset it.

## Mix Selection tabs

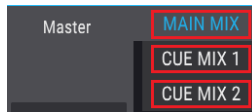

There are three tabs on the upper-right side of the Master fader section labeled Main Mix, Cue Mix 1, and Cue Mix 2. Each of these tabs selects an independent mixer, each with its own selection of input channels and controls (level, pan, solo and mute). This makes it possible to provide one mix to the monitor speakers, for example, and separate mixes to each of the headphones. Once a mix is constructed it can be routed to any output (Speakers, Aux Out, or either set of headphones).

Beneath the Mix Selection tabs are three sections that will help you assemble each mix quickly and make the most of them all.

## Add or Remove Tracks

The Add / Remove Tracks section defines which channels will be included in the selected mix. To open the Input Selection window, click the + / - button.

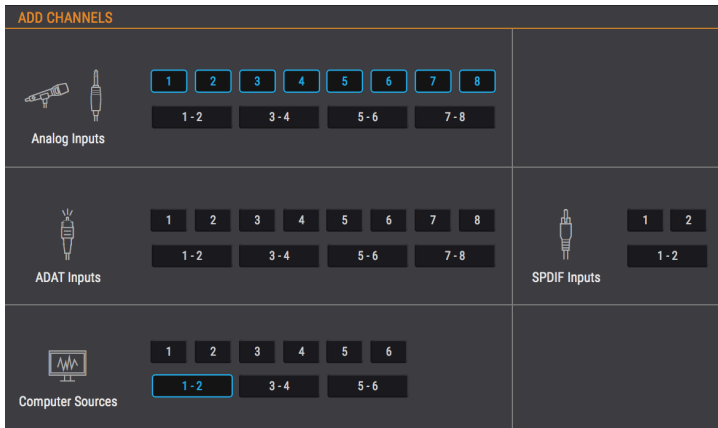

This shows all of the input sources that can be included in the selected mix. You can select individual sources by clicking on a number, or select stereo sources by clicking one of the buttons that contains two numbers. As each button is clicked a channel will be added or removed to the Channel display in the Monitoring Mix section, which remains visible in the background.

Note that input sources that are not included in the mix will not be heard in the mix.

### Channel display access slider



When a large number of input sources are added to the mix a slider appears along the bottom of the Monitoring Mix window, allowing you to access the input sources that have been pushed out of view.

Another method is to resize the AFCC window by click/dragging the triangle in the lower right corner. This will allow you to see all of the channels in the Monitoring Mix at the same time, depending on the number of included channels and the size of your monitor.

## Copy Mix

The selected mix might be a good starting point for constructing one of the other mixes. This feature lets you copy one mix to another, after which you can make any needed adjustments to levels, inputs, etc. Here's the process:

1. Select the source Mix (Main, Cue Mix 1, Cue Mix 2). For this example we'll select the Main Mix.
2. Click the Copy Mix button
3. Select the destination Mix by clicking its tab (Cue Mix 1 or Cue Mix 2).
4. After the selection has been confirmed, the source Mix will be copied onto the destination Mix.

## Grouping Tracks

This function lets you create and select different Track Groups within the selected mix, so you can adjust them all with a single action. Grouped tracks can be muted or soloed with a single click, for example, or you can adjust their levels by moving a single control.

There are four color-coded groups available for each mix. When a channel is added to a group, the name field under that channel's fader is highlighted with that same color.

To select a Track Group, click one of the four buttons. Once a group is selected you can adjust its settings as described above, or you can edit the group or clear it.

### Edit the Track Group

Follow these steps to assign or remove individual channels from a Track Group.

1. Click the Edit button.
2. Select the Track Group you want to edit by clicking its button.
3. Click the name field for the channel you want to assign or remove from the Track Group.
4. If you want to edit the contents of a different Track Group, simply select another Track Group button. Then follow the same steps to assign or remove the channels from that Track Group.
5. When you are done, click the Edit button to exit this mode.

### Clear the Track Group

If you want to remove all of the channels from a Track Group and start over, it's easy to do:

- Click the Clear button.
- Select the Track Group you want to clear by clicking its button.

All channels will be removed from the Track Group immediately.



⚠️ If a grouped track is removed from the mixer, it is no longer part of this group.



⚠️ alt+click allow to change a parameter of a grouped track without affecting the group.



## 2.4.3. Output zone

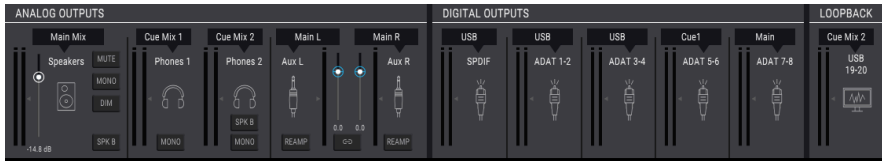

Stretching across the bottom of the AFCC window from left to right is the Output zone. It shows at a glance the signals that are passing through the AudioFuse Studio, along with the sources and levels as indicated by the LED meters. Each output has a drop-down menu that allows you to select which input source will be routed to which output.

Note that not all outputs are stereo pairs: The Aux L / R outputs are the exception. They can be routed and controlled independently or linked and controlled as a stereo pair. More about that later.

### 2.4.3.1. Analog Outputs

The source for each set of Analog Outputs can be selected. For example, there are three options for the Speakers: Main Mix, Cue Mix 1, and Cue Mix 2.

The following table lists all of the input / output routing options that are available in the selection menu for each analog output.

Speakers	Phones 1	Phones 2	Aux L	Aux R
Main Mix	Main Mix	Main Mix	Main L	Main Mix R
Cue Mix 1	Cue Mix 1	Cue Mix 1	Cue Mix 1 L	Cue Mix 1 R
Cue Mix 2	Cue Mix 2	Cue Mix 2	Cue Mix 2 L	Cue Mix 2 R
			USB [1]	USB [1]
			Analog Inputs 1-4	Analog Inputs 1-4

[1] The USB inputs for the Aux channels are the ones routed to them via the DAW or another computer source.

## The Analog Output buttons

There are 10 buttons in the Analog Outputs section. They make the AudioFuse Studio even more flexible and powerful!

### Mute

This button silences all of the Speaker outputs. Click it again to unmute.

### Mono

There's a Mono button available for three of the Analog Outputs. when this button is pressed the stereo output becomes mono. Use this to check your mix every now and then to make sure your listeners will not encounter any phase cancellation issues if they listen to your song through a single speaker.

### Dim

Clicking this button reduces the output level of the Speakers by an amount defined within the [AudioFuse Studio Preferences window \[p.50\]](#). Click it again to restore the level to its original setting. See [Audio Settings: AudioFuse Studio \[p.45\]](#) in the [Menu bar chapter \[p.42\]](#) for more information.

### Spk B

Two sets of monitor speakers can be connected to the AudioFuse Studio, and this button lets you switch between them for the selected output (Speakers or Phones 2). On the physical unit the Output Level knob controls the level for the Speakers, and the second Phones knob controls the level for Phones 2. The Master faders in the Monitoring Mix section can also control the levels, depending on the selected source for the specific Analog Output.

Remember, there are two configuration options available in the Audio Settings window that can be used to link and offset the speaker levels.

### Re-Amp

This button activates the Re-Amping feature for that Aux output (Left or Right. You can use both if needed). This causes the Aux output to switch its impedance to match the input on a guitar amplifier, enabling you to route a "clean" guitar recording into the guitar amp and re-record its output.

### Link

This button toggles the state of the Aux L and Aux R outputs between linked and unlinked. When linked they become a stereo pair, with a shared source and level. When unlinked their sources and levels can be different.

## 2.4.3.2. Digital Outputs

The source for each pair of Digital Outputs can be selected. For example, there are four options for digital outputs 1-2: Cue Mix, USB In 1-2, or Analog In 1-2.

This table lists all of the input / output routing options that are available in the selection menu for each digital output.

ADAT Out 1-2	ADAT Out 3-4	ADAT Out 5-6	ADAT Out 7-8	S/PDIF	Loopback
Main Mix	Main Mix	Main Mix	Main Mix	Main Mix	Main Mix
Cue Mix 1	Cue Mix 1	Cue Mix 1	Cue Mix 1	Cue Mix 1	Cue Mix 1
Cue Mix 2	Cue Mix 2	Cue Mix 2	Cue Mix 2	Cue Mix 2	Cue Mix 2
USB [1]	USB [1]	USB [1]	USB [1]	USB [1]	Disabled
				Speaker	
ADAT IN 1-2	ADAT IN 3-4	ADAT IN 5-6	ADAT IN 7-8	SPDIF IN 1-2	

[1] The USB input channels for these outputs are the ones routed to them via the DAW or another computer source.

### 2.4.3.3. Loopback section



The Loopback section provides two additional recording input channels that are not accessed through the front or rear panels of the AudioFuse Studio: USB channels 19 and 20. They are connected to a dedicated USB record stream, so the output of another application or of one of the AudioFuse studio monitoring mixer can be recorded directly by a DAW.

The source for the Loopback channels can be the Main Mix, Cue Mix 1, or Cue Mix 2 of the AudioFuse Studio. There is also a Disabled selection if this function is not required.



⏸ The Loopback section is only available when the sample rate is set to 44.1 kHz or 48 kHz.

## 3. SOFTWARE LICENSE AGREEMENT

In consideration of payment of the Licensee fee, which is a portion of the price you paid, Arturia, as Licensor, grants to you (hereinafter termed "Licensee") a nonexclusive right to use this copy of the SOFTWARE.

All intellectual property rights in the software belong to Arturia SA (hereinafter: "Arturia"). Arturia permits you only to copy, download, install and use the software in accordance with the terms and conditions of this Agreement.

The product contains product activation for protection against unlawful copying. The OEM software can be used only following registration.

Internet access is required for the activation process. The terms and conditions for use of the software by you, the end-user, appear below. By installing the software on your computer you agree to these terms and conditions. Please read the following text carefully in its entirety. If you do not approve these terms and conditions, you must not install this software. In this event give the product back to where you have purchased it (including all written material, the complete undamaged packing as well as the enclosed hardware) immediately but at the latest within 30 days in return for a refund of the purchase price.

**1. Software Ownership** Arturia shall retain full and complete title to the SOFTWARE recorded on the enclosed disks and all subsequent copies of the SOFTWARE, regardless of the media or form on or in which the original disks or copies may exist. The License is not a sale of the original SOFTWARE.

**2. Grant of License** Arturia grants you a non-exclusive license for the use of the software according to the terms and conditions of this Agreement. You may not lease, loan or sublicense the software. The use of the software within a network is illegal where there is the possibility of a contemporaneous multiple use of the program.

You are entitled to prepare a backup copy of the software which will not be used for purposes other than storage purposes.

You shall have no further right or interest to use the software other than the limited rights as specified in this Agreement. Arturia reserves all rights not expressly granted.

**3. Activation of the Software** Arturia may use a compulsory activation of the software and a compulsory registration of the OEM software for license control to protect the software against unlawful copying. If you do not accept the terms and conditions of this Agreement, the software will not work.

In such a case the product including the software may only be returned within 30 days following acquisition of the product. Upon return a claim according to § 11 shall not apply.

**4. Support, Upgrades and Updates after Product Registration** You can only receive support, upgrades and updates following the personal product registration. Support is provided only for the current version and for the previous version during one year after publication of the new version. Arturia can modify and partly or completely adjust the nature of the support (hotline, forum on the website etc.), upgrades and updates at any time.

The product registration is possible during the activation process or at any time later through the Internet. In such a process you are asked to agree to the storage and use of your personal data (name, address, contact, email-address, and license data) for the purposes specified above. Arturia may also forward these data to engaged third parties, in particular distributors, for support purposes and for the verification of the upgrade or update right.

**5. No Unbundling** The software usually contains a variety of different files which in its configuration ensure the complete functionality of the software. The software may be used as one product only. It is not required that you use or install all components of the software. You must not arrange components of the software in a new way and develop a modified version of the software or a new product as a result. The configuration of the software may not be modified for the purpose of distribution, assignment or resale.

**6. Assignment of Rights** You may assign all your rights to use the software to another person subject to the conditions that (a) you assign to this other person (i) this Agreement and (ii) the software or hardware provided with the software, packed or preinstalled thereon, including all copies, upgrades, updates, backup copies and previous versions, which granted a right to an update or upgrade on this software, (b) you do not retain upgrades, updates, backup copies and previous versions of this software and (c) the recipient accepts the terms and conditions of this Agreement as well as other regulations pursuant to which you acquired a valid software license.

A return of the product due to a failure to accept the terms and conditions of this Agreement, e.g. the product activation, shall not be possible following the assignment of rights.

**7. Upgrades and Updates** You must have a valid license for the previous or more inferior version of the software in order to be allowed to use an upgrade or update for the software. Upon transferring this previous or more inferior version of the software to third parties the right to use the upgrade or update of the software shall expire.

The acquisition of an upgrade or update does not in itself confer any right to use the software.

The right of support for the previous or inferior version of the software expires upon the installation of an upgrade or update.

**8. Limited Warranty** Arturia warrants that the disks on which the software is furnished is free from defects in materials and workmanship under normal use for a period of thirty (30) days from the date of purchase. Your receipt shall be evidence of the date of purchase. Any implied warranties on the software are limited to thirty (30) days from the date of purchase. Some states do not allow limitations on duration of an implied warranty, so the above limitation may not apply to you. All programs and accompanying materials are provided "as is" without warranty of any kind. The complete risk as to the quality and performance of the programs is with you. Should the program prove defective, you assume the entire cost of all necessary servicing, repair or correction.

**9. Remedies** Arturia's entire liability and your exclusive remedy shall be at Arturia's option either (a) return of the purchase price or (b) replacement of the disk that does not meet the Limited Warranty and which is returned to Arturia with a copy of your receipt. This limited Warranty is void if failure of the software has resulted from accident, abuse, modification, or misapplication. Any replacement software will be warranted for the remainder of the original warranty period or thirty (30) days, whichever is longer.

**10. No other Warranties** The above warranties are in lieu of all other warranties, expressed or implied, including but not limited to, the implied warranties of merchantability and fitness for a particular purpose. No oral or written information or advice given by Arturia, its dealers, distributors, agents or employees shall create a warranty or in any way increase the scope of this limited warranty.

**11. No Liability for Consequential Damages** Neither Arturia nor anyone else involved in the creation, production, or delivery of this product shall be liable for any direct, indirect, consequential, or incidental damages arising out of the use of, or inability to use this product (including without limitation, damages for loss of business profits, business interruption, loss of business information and the like) even if Arturia was previously advised of the possibility of such damages. Some states do not allow limitations on the length of an implied warranty or the exclusion or limitation of incidental or consequential damages, so the above limitation or exclusions may not apply to you. This warranty gives you specific legal rights, and you may also have other rights which vary from state to state.

## 4. DECLARATION OF CONFORMITY

### USA

#### **Important notice: DO NOT MODIFY THE UNIT!**

This product, when installed as indicate in the instructions contained in this manual, meets FCC requirement. Modifications not expressly approved by Arturia may avoid your authority, granted by the FCC, to use the product.

*IMPORTANT:* When connecting this product to accessories and/or another product, use only high quality shielded cables. Cable (s) supplied with this product **MUST** be used. Follow all installation instructions. Failure to follow instructions could void your FCC authorization to use this product in the USA.

*NOTE:* This product has been tested and found to comply with the limit for a Class B Digital device, pursuant to Part 15 of the FCC rules. These limits are designed to provide a reasonable protection against harmful interference in a residential environment. This equipment generate, use and radiate radio frequency energy and, if not installed and used according to the instructions found in the users manual, may cause interferences harmful to the operation to other electronic devices. Compliance with FCC regulations does not guarantee that interferences will not occur in all the installations. If this product is found to be the source of interferences, witch can be determined by turning the unit "OFF" and "ON", please try to eliminate the problem by using one of the following measures:

- Relocate either this product or the device that is affected by the interference.
- Use power outlets that are on different branch (circuit breaker or fuse) circuits or install AC line filter(s).
- In the case of radio or TV interferences, relocate/ reorient the antenna. If the antenna lead-in is 300 ohm ribbon lead, change the lead-in to coaxial cable.
- If these corrective measures do not bring any satisfied results, please the local retailer authorized to distribute this type of product. If you cannot locate the appropriate retailer, please contact Arturia.

The above statements apply **ONLY** to those products distributed in the USA.

### CANADA

*NOTICE:* This class B digital apparatus meets all the requirements of the Canadian Interference-Causing Equipment Regulation.

*AVIS:* Cet appareil numérique de la classe B respecte toutes les exigences du Règlement sur le matériel brouilleur du Canada.



This product complies with the requirements of European Directive 89/336/EEC

This product may not work correctly by the influence of electro-static discharge; if it happens, simply restart the product.