

KORCO

Pa5X

USER

MANUAL

Important safety instructions

- Read these instructions.
- Keep these instructions.
- Heed all warnings.
- Follow all instructions.
- Do not use this apparatus near water.
- Clean only with dry cloth.
- Do not block any ventilation openings. Install in accordance with the manufacturer's instructions.
- Do not install near any heat sources such as radiators, heat registers, stoves, or other apparatus (including amplifiers) that produce heat.
- Do not defeat the safety purpose of the polarized or grounding-type plug. A polarized plug has two blades with one wider than the other. A grounding type plug has two blades and a third grounding prong. The wide blade or the third prong are provided for your safety. If the provided plug does not fit into your outlet, consult an electrician for replacement of the obsolete outlet.
- Protect the power cord from being walked on or pinched particularly at plugs, convenience receptacles, and the point where they exit from the apparatus.
- Only use attachments/accessories specified by the manufacturer.
- Use only with the cart, stand, tripod, bracket, or table specified by the manufacturer, or sold with the apparatus. When a cart is used, use caution when moving the cart/apparatus combination to avoid injury from tip-over.
- Unplug this apparatus during lightning storms or when unused for long periods of time.
- Refer all servicing to qualified service personnel. Servicing is required when the apparatus has been damaged in any way, such as power-supply cord or plug is damaged, liquid has been spilled or objects have fallen into the apparatus, the apparatus has been exposed to rain or moisture, does not operate normally, or has been dropped.
- **WARNING** – This apparatus shall be connected to a mains socket outlet with a protective earthing connection.
- Turning off the standby switch does not completely isolate this product from the power line, so remove the plug from the socket if not using it for extended periods of time, or before cleaning. Please ensure that the mains plug or appliance coupler remains readily accessible.
- Mains powered apparatus shall not be exposed to dripping or splashing and that no objects filled with liquids, such as vases, shall be placed on the apparatus.
- Install this product near the wall socket and keep the power plug easily accessible.
- Do not install this equipment in a confined space such as a box for the conveyance or similar unit.
- No naked flame sources, such as lighted candles, should be placed on the apparatus.





WARNING – Do not ingest battery, chemical burn hazard. This product contains a coin/button cell battery.

If the coin/button cell battery is swallowed it can cause severe internal burns in just 2 hours and can lead to death.

Keep new and used batteries away from children. If the battery compartment does not close securely, stop using the product and keep it away from children.

If you think the battery may have been swallowed or placed inside any part of the body seek immediate medical attention.

- **WARNING** – Date/time Lithium button cell battery inside. Danger of explosion if the battery is incorrectly replaced. Replace only with the same or equivalent type. The internal date/time Lithium button cell battery is user replaceable.
- Do not expose batteries to excessive heat, such as direct sunshine, fire or the like.
- Dispose of used batteries according to the battery manufacturer's instructions.

WARNING:

TO REDUCE THE RISK OF FIRE OR ELECTRIC SHOCK DO NOT EXPOSE THIS PRODUCT TO RAIN OR MOISTURE.



The lightning flash with arrowhead symbol within an equilateral triangle, is intended to alert the user to the presence of uninsulated “dangerous voltage” within the product’s enclosure that may be of sufficient magnitude to constitute a risk of electric shock to persons.



The exclamation point within an equilateral triangle is intended to alert the user to the presence of important operating and maintenance (servicing) instructions in the literature accompanying the product.

Other notices

Automatic power-off

To avoid wasting power, Pa5X will by default automatically enter standby mode after two hours not using it (playing, pressing buttons or using the touch-screen). Please save your data (Keyboard Sets, Styles, Songs, and so on) before taking a prolonged pause.

Data handling

Data in memory may sometimes be lost due to incorrect user action. Be sure to save important data to the internal memory or to an external USB device. KORG will not be responsible for damages caused by data loss.

Display handling

Be very careful not to force the display when tilting it. Fully lower the display before carrying the instrument. Also, be very careful not to apply too much pressure on the display while carrying the instrument, or it might break.

Cleaning

If the exterior becomes dirty, wipe it with a clean, dry cloth. Do not use liquid cleaners such as benzene or thinner, or cleaning compounds or flammable polishes.

Use a soft cotton cloth to clean the display. Some materials, such as paper towels, could cause scratches and damage it. Computer wipes are also suggested, provided they are specifically designed for LCD screens.

Do not spray any liquid on the LCD screen directly. Always apply the solution to your cloth first, then clean the screen.

Wooden sides

The instrument's sides are made of natural wood, whose characteristics vary from piece to piece. The more it is used, the more beautiful it will become. If you notice any irregularities, these are to be considered unique intrinsic characteristics, which further enhance its natural origin.

Example screens

Some pages of the manuals show snapshots of the screen along with an explanation of functions and operations. All sound, style, song or parameter names, as well as shown values, are merely examples and may not always match the actual display you are working on.

Trademarks

Mac and iOS are registered trademarks of Apple, Inc. Android is a trademark of Google Inc. MS-DOS and Windows are registered trademarks of Microsoft Corporation. Waves MaxxAudio® is a trademark of Waves Audio Ltd. All other trademarks or registered trademarks are the property of their respective holders.

Open source notice

Portions of this product's software are copyright ©2007 "The FreeType Project" (www.freetype.org). All rights reserved.

Disclaimer

The information contained in this manual have been carefully revised and checked through. Due to our constant efforts to improve our products, the specifications might differ to those in the manual. KORG is not responsible for any differences found between the specifications and the contents of the instruction manual – all specifications being subject to change without prior notice.

Liability

KORG products are manufactured under strict specifications and voltages required by each country. These products are warranted by the KORG distributor only in each country. Any KORG product not sold with a warranty card or carrying a serial number disqualifies the product sold from the manufacturer's/distributor's warranty and liability. This requirement is for your own protection and safety.

Service and user's assistance

For service, please contact your nearest Authorized KORG Service Center. For more information on KORG products, and to find software and accessories for your keyboard, please contact your local Authorized KORG distributor. For up-to-date information, please point your web browser to our [web site](#).

Keep your instrument up-to-date

Your instrument can be constantly updated as new versions of the operating system are released by KORG. You can download the operating system from our web site (www.korg.com/us/support/download/). Please, read the instructions supplied with the operating system.

Contents

PLAY

- 01** **1** **Let's start!**
 - 2 Introduction
 - 6 The front panel
 - 8 The control panel
 - 13 The rear panel
 - 17 Connecting the pedals
 - 18 Connecting the audio outputs
 - 20 Powering up

- 02** **27** **The User Interface**
 - 28 The Main page
 - 32 The Home mode
 - 34 The File mode
 - 36 The Settings mode
 - 38 The Record/Edit modes
 - 41 The user interface in detail
 - 54 Going through the pages
 - 61 Choosing the musical resources
 - 67 Display Hold
 - 68 The Player and the Tracks
 - 70 Saving the musical resources

- 03** **73** **Playing the Sounds**
 - 74 The Keyboard Sets
 - 87 Customizing the Keyboard Sets
 - 103 The Favorite Keyboard Sets

04	107	Volume and Control
	108	Adjusting the volume
	111	The Control section
05	125	Tempo and Metronome
	126	Tempo
	130	Metronome
06	133	Playing the Styles
	134	The Styles
	145	Playing the Styles
	158	Setting the Style play controls
07	175	Playing the Pads
	176	The Pads
	177	Playing the Pads
	180	Customizing the Pad set
08	187	Playing the Chord Sequences
	188	The Chord Sequences
	197	Playing the Chord Sequences
09	199	Playing the Songs
	200	The Songs
	207	Playing the Songs
	214	Playing a list of songs (Jukebox)
	224	The special tracks (Melody, Drum & Bass)
10	229	Lyrics, Chords, Markers, Score
	230	Lyrics and chords
	243	The Markers
	251	The Score
11	257	The SongBook
	258	Using the SongBook
	268	Quick creation of a new SongBook Entry
	270	Editing the SongBook

- 283 Managing the SongBook Entries
- 287 Using the Set Lists
- 292 Editing the Set Lists
- 297 Exporting the Book and Set Lists as a text file
- 299 Using the SongBook with a tablet or personal computer

12 **303 The Matrix**

- 304 Using the Matrix
- 308 Programming the Matrix

CUSTOMIZE

13 **315 Editing and saving the Sound combinations**

- 316 Editing the Sound combinations
- 323 Saving a Keyboard Set
- 332 Saving the current Style
- 333 Saving a Pad
- 336 Saving the current MIDI Song

14 **337 The Mixer**

- 338 The Mixer
- 357 Saving the Mixer settings

15 **359 The Effects**

- 360 The Insert and Master Effects
- 380 Saving the Insert and Master Effects settings
- 381 The Finalizer
- 389 Saving the Finalizer settings

16 **391 The Track parameters**

- 392 Tuning
- 394 Routing and polyphony
- 397 Quick editing of Sounds and Drum Kits
- 402 Setting the key and velocity range
- 404 Saving the Track settings

17	405	Digital Drawbars
	406	The Digital Drawbars
	414	Editing the Digital Drawbars
18	423	Global settings and Preferences
	424	Customizing the user interface
	429	Automatic selection and locking
	438	System preferences
19	441	Tuning and Scale
	442	Master Transpose and Tuning
	455	Scale
20	469	Controllers
	470	User settings for the Control sliders and buttons
	472	Assignable Switches
	474	Hand controllers
	480	Foot controllers
	486	Assignable functions
21	497	MIDI
	498	Introduction to MIDI
	503	Connecting MIDI devices
	513	Quick setup using the MIDI Presets
	524	Synchronizing with other instruments
	526	Routing, processing and transposing
	533	Programming the MIDI channels
	538	Control Change messages
	542	Controlling the Styles and Songs via MIDI
	544	Controlling the Mic and Guitar Processors via MIDI
	548	Controlling other musical resources via MIDI
22	549	Audio Outputs
	550	Routing the internal Sounds to the outputs
	555	Routing the MP3 Songs to the outputs
	558	Routing the metronome to the outputs
	559	Setting the mastering effects on the audio outputs

23	571	Microphone Input
	572	Connecting a microphone
	579	Shaping the microphone input
	586	Talking with your audience
	589	Using the microphone effects and harmonization
24	603	Guitar Input
	604	Connecting a guitar
	610	Shaping the guitar input
	611	Using the guitar effects
25	619	Line Audio Inputs
	620	Connecting a line audio device
26	625	File, Search and Drives
	626	Searching for files and other elements
	631	Using musical resources directly from the drives
	633	Overview on file management
	646	Loading Pa5X data from the drives
	654	Importing data from other instruments
	656	Saving Pa5X data to the drives
	665	Copying and moving data
	675	Renaming files and folders
	677	Deleting files and folders
	678	Creating new folders or banks
	680	Formatting a drive
	682	Getting information on drives and files
	685	Protecting storage devices and files
	687	Changing the file display preferences
	688	Backing up and restoring the musical resources
	694	Restoring the original Factory data
	696	Accessing the internal drives from a personal computer
	698	Care of the storage devices

RECORD/EDIT

- 27** **701** **Recording Audio**
 - 702 Recording MP3 Songs

- 28** **707** **Recording and editing the Songs**
 - 708 The Song Edit mode
 - 711 Recording MIDI Songs
 - 718 The Mixer and the Effects
 - 719 The Track parameters
 - 720 Editing the MIDI events
 - 725 Saving the MIDI Songs

- 29** **727** **Recording and editing the Styles and Pads**
 - 728 Overview on the Style and Pads
 - 735 Accessing the Style and Pad Record mode
 - 742 Choosing the Style and Pad Sounds
 - 748 Recording the Styles or Pads in realtime
 - 760 Recording a Guitar track
 - 774 Editing the Styles and Pads
 - 806 Importing and exporting the Styles and Pads
 - 812 Saving the Style or Pad

- 30** **819** **Recording the Chord Sequences**
 - 820 Recording Chord Sequences
 - 822 Saving a Chord Sequence

- 31** **827** **Editing the Sounds**
 - 828 Editing Sounds
 - 834 Customizing the Sounds
 - 837 Full editing of the Sounds
 - 912 Saving the Sounds
 - 913 AMS (Alternate Modulation Sources)

- 32** **917** **Editing the Samples**
 - 918 Making new sounds with Sampling
 - 921 Loading samples and multisamples

- 930 Recording samples or audio grooves
- 935 Editing the samples
- 944 Saving, exporting or deleting the samples
- 951 Multisamples
- 957 Saving, exporting or deleting the multisamples
- 961 Sounds and Drum Kits
- 964 Audio Grooves

- 33** **977 Effects for the Microphone**
- 978 Editing the Mic Presets
- 1000 Saving the Mic Presets

- 34** **1001 Effects for the Guitar**
- 1002 Editing the Guitar Presets
- 1006 Saving the Guitar Presets

- 35** **1007 Effects for the Sounds**
- 1008 Editing the effects
- 1021 Effect parameters

APPENDIX

- 36** **1317 Musical Resources**
- 1318 Keyboard Set Library
- 1322 Sounds
- 1357 Drum Kits
- 1361 DNC Sounds and controls
- 1369 Multisamples
- 1399 Drum Samples
- 1477 Styles
- 1482 Pads
- 1485 Chord Sequences
- 1487 Recognized chords

- 37** **1491 Video connections**
- 1492 Connecting an external display

38**1495 Installing the options**

1496 Assembling the music stand

1498 Replacing the clock battery

1503 Installing a microSD card

39**1509 Shortcuts, Solutions, Specs**

1510 Shortcuts

1513 Troubleshooting

1515 Specifications

PLAY

01

Let's start!

Introduction

Welcome to Pa5X!

Many thanks, and congratulations on purchasing the KORG Pa5X Professional Arranger! We're sure it'll give you countless hours of enjoyment making great music on a stage or at home.

Pa5X is an elegant and powerful music production workstation. It is easy to use, with a clear user interface, based on the reclinable color touch screen, and the illuminated buttons on the control panel showing color-coded functions. The naturally responsive 88-note piano-like hammer-action keyboard, and the 76- and 61-note semi-weighted keyboards, are designed for a completely authentic feel and full control of expression.

Robust and reliable, Pa5X is excellent as a live instrument, but it is also a powerful creative tool in studio, helping you in writing songs or soundtracks, while generating a produced sound that makes the perfect demo or ready-to-use media music.

The onboard sounds, based on our EDS-X (Enhanced Definition Synthesis-eXpanded) sound engine, range from ultra-realistic acoustic instruments, to electric vintage keyboards, to synth classics, with the addition of fantasy sounds and special effects for media and cinema production. We also included instruments from various ages and cultures, leaving ample room for your own expansions.

Pa5X is easy to control, via the KORG's DNC (Defined Nuance Control) system, allowing the performer to accurately and expressively introduce the most subtle nuances and sound articulation. Faders, switches, real and virtual matrices of real time controls, a joystick and a ribbon controller, allow for immediate access to all the parameters of the sound. A complete set of programmable sliders and buttons is associated to a dedicate strip display.

The sounds are processed by an elaborate chain of effects for each of the Players and for the Keyboard Sounds. Each Player even includes a finalizer module. The final mastering effects on the audio outputs, making the instrument's sound 'blended' and 'produced', are the result of KORG's long term cooperation with Waves Audio, the world reference in studio mastering effects.

To listen with the best audio quality, even at the lowest volume for rehearsing at night, you can add the optional KORG PaAS Amplification System, which has been specifically designed to connect directly to Pa5X.

The optional modern, stylish dedicated ST-SV1-BK stand makes the instrument a solid statement on stage, and a stylish piece of modern furniture in your living room.

Pa5X's included KORG XDS Crossfade Dual Sequencer/Player can be used to freely preload and mix Styles and Songs. You can also create your own Styles, and record your own MIDI and MP3 Songs. Automatic harmonization, the chord sequencer, a sophisticated chord recognition engine, can create the rich arrangement of a competent pop or jazz player.

With both Songs and Styles you can show lyrics and chords in the internal or an external display, and you can convert any MIDI Song track into a readable score. Markers allow for jumping back to a passage you wish to repeat, for example in a piece you are studying or rehearsing, or for repeating a section live.

You can record a MIDI Song using a full-featured Sequencer. Even easier, just record what you sing and play (including MP3 Songs) as an MP3 file, and listen to it anywhere you like.

Song and Style can be saved into the onboard SongBook, together with all the associated sounds, effects, lyrics and chords. These database-like entries are easy to synchronize with external score readers on a tablet. You can therefore use a digital music book to control your Pa5X. And you can create your own set lists, each one dedicated to a style or a show.

Voice and guitar can be connected to the dedicated audio inputs, and processed with the excellent onboard effects. Our long experience in vocal harmonies and guitar effects is entirely included here. And the Vocal Remover will let you sing along with any MP3 Song.

There is more, much more, and we invite you to explore Pa5X in depth. Pa5X is the most evocative, powerful, easy-to-use complete Professional Arranger ever produced. Enjoy your musical life with the new Pa5X!

Before starting to play...

What's in the box

After you get your Pa5X, please check that all the listed items are included in the package. If any of them is missing, please contact your KORG dealer immediately.

- > Pa5X
- > Music stand
- > AC power cable
- > Quick Guide
- > Pa5X88 only: Safety felts for the ST-SV1-BK stand

What you can download

Point your web browser to our web site (www.korg.com/us/support/download/), to download the most up-to-date software, the full User Manual, an easier Performance Guide, the video tutorials, a MIDI driver.

What you can add

After having purchased Pa5X, you might want to add these other fine options:

- > The elegant KORG ST-SV1-BK keyboard stand, recommended for safety and comfort, perfectly matching your arranger design.

CAUTION: The Pa5X Professional Arranger is intended for use only with the KORG ST-SV1-BK stand. Use with another stand may result in instability and cause injury.

- > The PaAS Amplification System, adding a three-way amplification system, a pair of integrated speakers and a bass-reflex box.
- > One of the sturdy pedals and footswitches from the KORG catalogue.

Contacts

Your KORG dealers not only deliver this instrument, but also carry hardware and software accessories, as well as useful information on how to use these products. Ask them for any help you should eventually need.

Our international web site is www.korg.com. A list of all KORG Distributors can be found in our dedicated web page (www.korg.com/us/corporate/distributors/).

Making a safety copy of your data

In case you like to customize your musical resources, we suggest you do frequent backups of your data. Press the **FILE** button to go to the **File** page, select the **Internal** group, select the **All** folder, and choose the **Save** command from the **page menu** (on the top right corner). Then save the data as a KST folder in an external storage device.

Restoring a safety copy

To restore a backup of your User data, reload the KST folder where you saved them. If it is an external device, connect the backup storage device. Press the **FILE** button to go to the **File** page, select the **Drives** group and then the external storage device. Select the KST folder where you backed up your data, and choose the **Load** command from the **page menu** (on the top right corner). Then load the data into the internal memory. If you like, you can only reload some individual elements.

Restoring the original factory data

In case you want to restore the original factory data, use the **Factory Restore** command you can find in the **File > Menu > Restore** page.

WARNING: This operation will overwrite all the User data!

Loading the Operating System

Your Pa5X can be constantly updated as new versions of the operating system are released. You can download the most up-to-date operating system from our web site (www.korg.com/us/support/download/). Please, read the instructions supplied with the operating system.

You can see which version of the operating system is installed in your Pa5X by going to the **File** pages, and choosing the **System Info** command from the **page menu**.

HINT: Be sure your Pa5X always includes the latest version of the operating system. This may contain new features and bug fixes.

WARNING: Do not install an OS other than the official OS supplied by KORG for the Pa5X. Trying to install an OS created for different models or downloaded from unofficial web sites may cause data loss and permanent damage to the instrument. KORG is not responsible for any damage caused by improper installation of the OS.

The front panel

The front panel is where you can find the instrument's controls.

Slide guide for the music stand and PaAS amplification system



Headphones

Keyboard

Keyboard

Use the keyboard to play notes and chords. Depending on the status of the **SPLIT** indicator, the keyboard may be joint or split between different sounds.

Headphones connector

Connect a pair of headphones to this output. You can use headphones with an impedance of 16-200 Ohms (50 Ohms suggested).

Music stand

A music stand is included with your Pa5X (see page 1496 for instructions on how to assemble it).

PaAS amplification system

You can install the (optional) PaAS amplification system. When installed, control the output volume of the speakers via the **MASTER VOLUME** slider.

The speakers are automatically deactivated when connecting the headphones. You can also manually deactivate them by deselecting the **Speakers** checkbox in the **Settings > Audio/Video > MP3/Speakers** page.

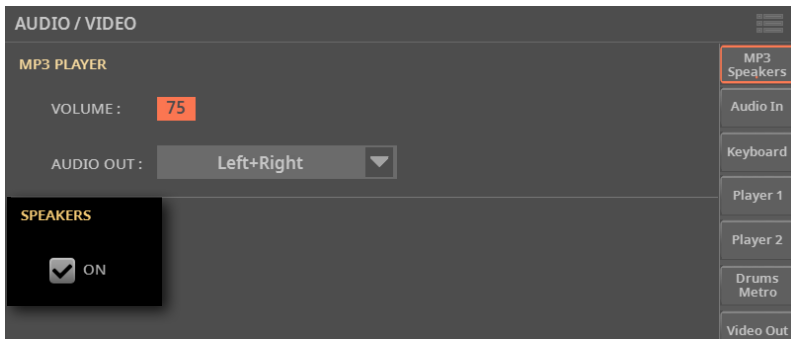

The control panel

The control panel is the part of the front panel where you can find the instrument's controls.

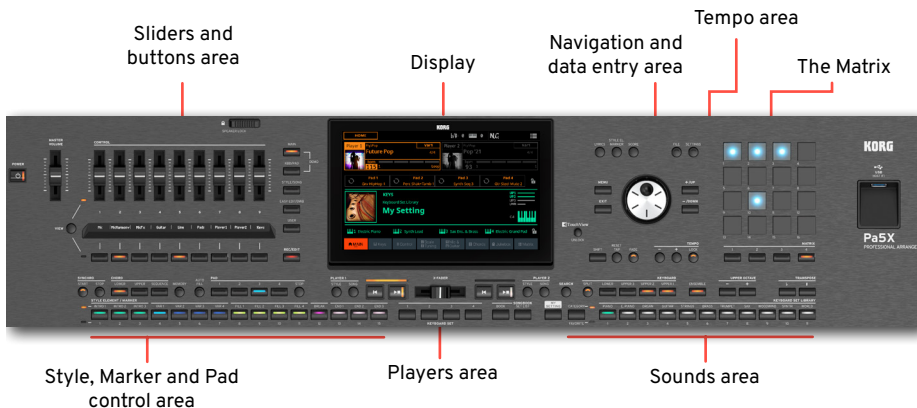

Sliders and buttons

Use this section to control each element of your performance in real time. The mode button on the right select one of the available function groups. The small strip display always shows what the controllers are doing. (See [The Control section](#) on page 111).



Display

Use this touchscreen display to interact with the instrument. The display can be tilted for optimal visualization. There are controls around the display, to help you select the various elements.



Navigation and data entry area

Use these controls to go through the menus, pages and parameters, and change the value of the selected parameter.



Sounds area

Sounds are what you can play on the keyboard. Here you can choose combinations of Sounds saved as Keyboard Sets in a dedicated library. (See [Playing the Sounds](#) on page 73).

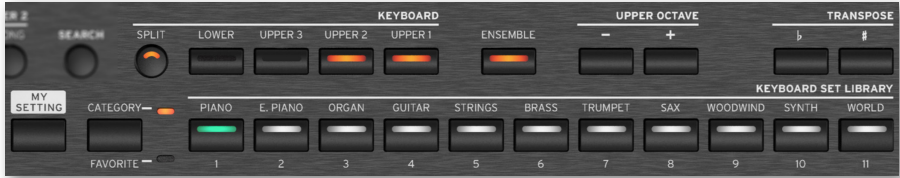

Styles, Pads and Markers area

Styles supply the automatic accompaniment with a virtual band. Markers allow jumping to saved points in the Song. You can play Sounds (selected via the Keyboard Sets) and Pads along with the Styles and Songs. (See [Playing the Styles](#) on page 145 and [The Markers](#) on page 243).

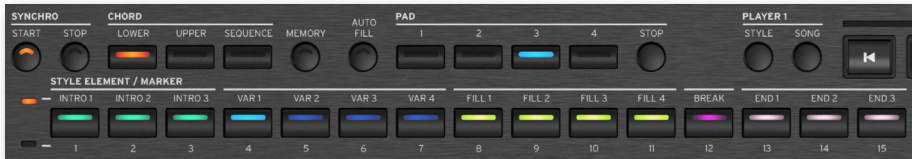

Players area

Styles and Songs can be played back by the two onboard Players. You can assign different elements to each Player, to have another Style or Song ready to play. You can mix the two Players with the **X-FADER**. (See [Playing the Styles](#) on page 133 and [Playing the Songs](#) on page 199).



SongBook area

The SongBook is a database of ‘songs’, called SongBook Entries. Each of them is a snapshot of the current situation, including the selected Style, Song, Keyboard Set, Pads, Chord Sequences and Voice and Guitar effects. You can quickly access all the songs in the SongBook (Book), or selected lists of songs (Set Lists). (See [The SongBook](#) on page 257).



Tempo area

Use these buttons to control the Tempo of the Styles and the Songs (see page 125). You can turn a metronome click on or off by pressing the **CONTROL > SWITCH #9** button while in **STYLE/SONG** mode, and practice with the metronome



The Matrix

You can use this programmable matrix of big, easy accessible keys to trigger elements and functions. (See [The Matrix](#) on page 303).

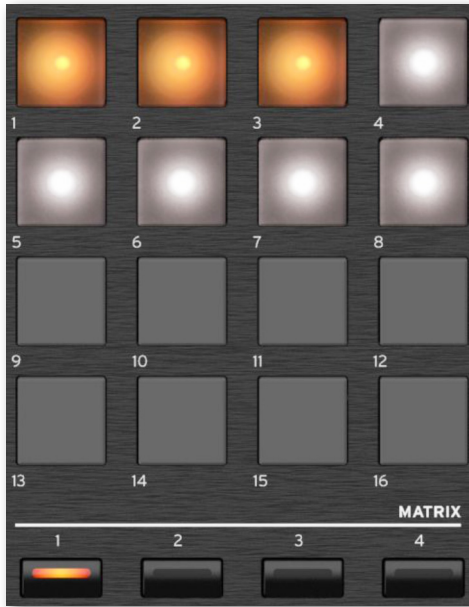

USB connector

Use this socket to connect an USB memory device, like an USB pendrive, or other musical instruments to be used as controllers. You can also use it to attach a small USB lamp and illuminate the control panel or the music stand. Please note that two other ports are on the back of the instrument.

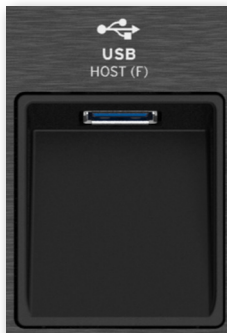

The rear panel

The rear panel is where you can find the various connections.

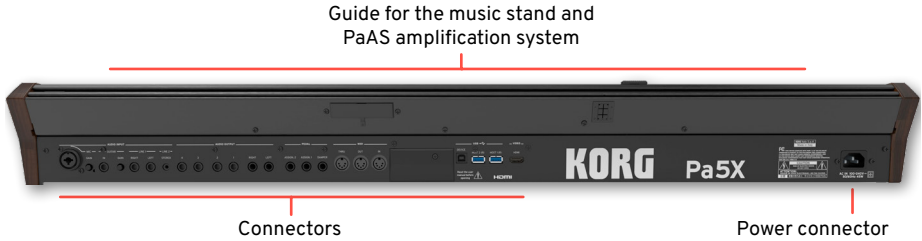

Audio inputs

Use these connectors to connect a microphone, a guitar or another musical instrument. The handy **STEREO** minijack can be used to directly connect the audio output of a media player, a smartphone or a tablet. (See starting from [page 571](#)).



Audio outputs

Use the LEFT/RIGHT sockets to send the stereo audio signal to a mixer, a PA system, a set of powered monitors, or your hi-fi system. Four separate audio outputs (1-4) are also available. (See [Connecting the audio outputs](#) on page 18 and [Audio Outputs](#) on page 549).



Pedal connectors

Use the **DAMPER** connector to connect a damper pedal, and the **ASSIGNABLE** connectors to connect either a continuous pedal or footswitch. (See [Foot controllers](#) on page 480).

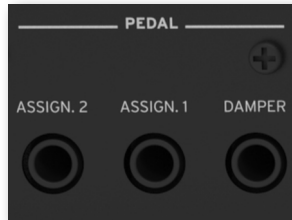

MIDI ports

Use these ports to connect Pa5X to external controllers (master keyboard, MIDI guitar, wind controller, MIDI accordion, MIDI pedalboard...), to a series of expanders, or to a computer with a MIDI interface. (See [MIDI](#) on page 497).

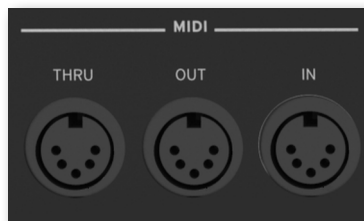

Battery and microSD slot

This opening contains the clock battery and the microSD card slot.



USB ports

Use these sockets to connect your Pa5X to a personal computer or a tablet (**DEVICE**) or to connect up to two USB memory device, like an USB pendrive, or another musical instrument to be used as a controller (**HOST1-R**, **HOST2-R**). Another **HOST** socket (**HOST-F**) is available on the front panel. (See [MIDI](#) on page 497 and [File, Search and Drives](#) on page 625).

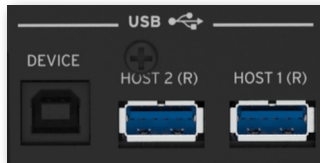

Video out

Connect Pa5X to a TV or video monitor, to read lyrics and chords on a bigger display. (See [Video connections](#) on page 1491).



Power connector

Use this socket to plug in the supplied IEC power cable.

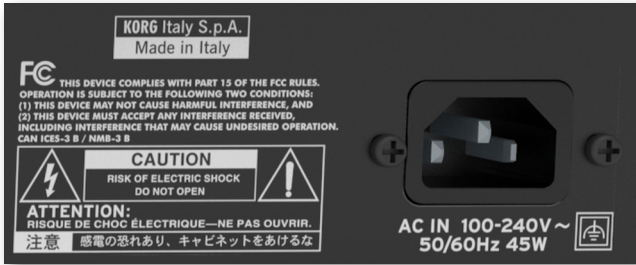

Plug the other end of the cable to an AC power outlet. Be sure to use a compatible plug. Never force the plug into the socket!

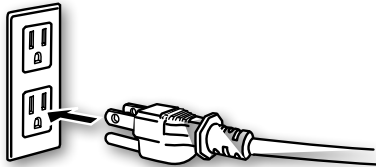

WARNING: Connect the plug to an AC socket of matching voltage! Please read the safety information at the beginning of this manual.

Connecting the pedals

Connecting the damper pedal

Use the **PEDAL > DAMPER** connector to connect a damper pedal, like the (optional) KORG PS-1, PS-3 or DS-1H. The DS-1H pedal supports all the nuances of half-pedaling on some acoustic piano sounds. You can experiment how it works by gradually pressing it down, and gradually releasing it, while playing the **Concert Grand Sound**.

If you need to change the pedal's polarity and calibrate it, go to the **Settings > Controllers > Foot** page.

Connecting a pedal or footswitch

Use the **PEDAL > ASSIGNABLE** connector to connect a footswitch pedal like the (optional) KORG PS-1, PS-3 or DS-1H, or a continuous pedal like the (optional) KORG XVP-20 Volume pedal or the EXP-2 Expression pedal.

By default, this connector will work as an Expression pedal. If you want to change the assigned function, or you need to change the pedal's polarity and calibrate it, go to the **Settings > Controllers > Foot** page.

What if the pedals do not behave correctly?

If needed, you might want to recalibrate the pedals. Or you might need to reverse the pedal's polarity. See how to do in [Calibrating the pedals and setting their polarity](#) on page 484.

Connecting the audio outputs

Connecting the headphones

Connect a pair of headphones to the **PHONES** connector. You can use headphones with an impedance of 16-200 Ohms (50 Ohms suggested). When connecting the headphones, the PaAS speakers are automatically deactivated.

Adjust the output level with the **MASTER VOLUME** slider.

Connecting the line audio outputs

Use the **AUDIO OUTPUT** connectors to send the audio output to a mixer, a set of powered monitors, or an audio amplification system. These are balanced/unbalanced (TRS) 6.35 mm, or 1/4", jack connectors. (Please note that balanced connectors and cables are also called stereo, while the unbalanced ones are called mono).

Where possible, use all balanced connections, to reduce the risk of noise (hum) occurring in the audio signal.



Pa5X's AUDIO OUT
(2 x 6.35 mm / 1/4" balanced jacks)

Mixer's/Amplification's LINE IN
(2 x 6.35 mm / 1/4" balanced jacks)



Pa5X's AUDIO OUT
(2 x 6.35 mm / 1/4" unbalanced jacks)

Mixer's/Amplification's LINE IN
(2 x 6.35 mm / 1/4" unbalanced jacks)

When using a home audio amplifier, connect the other end of the cable to the CD, LINE IN or TAPE/AUX input of your audio system. Don't use the PHONO inputs of your audio system!

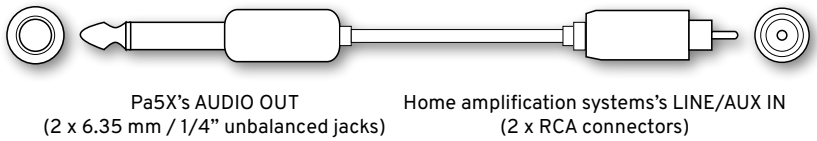

- > Use the **LEFT** and **RIGHT** connectors as the main stereo outputs. Connect either of them to output a mono signal. Adjust the output level with the **MASTER VOLUME** slider.
- > Use the **1-4** connectors as separate sub-outputs. These can be used as stereo sub-mixes, or as individual outputs, to process and mix individual sounds with an external mixer or amplification system. The sounds are sent to these outputs with the Insert FXs applied. Master FX and the MaxxAudio are deactivated. The **MASTER VOLUME** is not applied to these outputs. The **X-FADER** changes the balance between the Players on these outputs. Adjust their volume with the mixer's or external speaker's level controls.

If installed, the (optional) **PaAS** amplification system will work in parallel with the main audio outputs.

Powering up

Turning the instrument on

Connecting the power cable

Plug the supplied power cable into the **POWER** socket on the back of the instrument, and the cable plug into a wall power socket.

When the cable is connected, the instrument is in standby.

WARNING: When the instrument is in standby, it is still connected to the power line. Accessing the inside of the instrument can be dangerous. To completely disconnect the instrument from the power, unplug the power plug from the power socket on the wall.

Turning the power on or off

■ Turn the instrument on

> Press the **POWER** (🔌) button to turn the instrument on (that is, 'exit from standby'). After you turn the instrument on, wait for the welcome screen to disappear, then the Main page will be shown in the display.

■ Turn the instrument off (standby)

> Keep the **POWER** (🔌) button pressed for about two seconds, then release it when the screen appears dimmed. The shutdown procedure will begin and last for a few seconds. Please do not disconnect the power cable during this procedure.

Tilting the display

For optimal visibility under any seating position, the display's tilt angle can be adjusted.

Lifting the display

- 1 Press the **UNLOCK** button to unlatch the display.

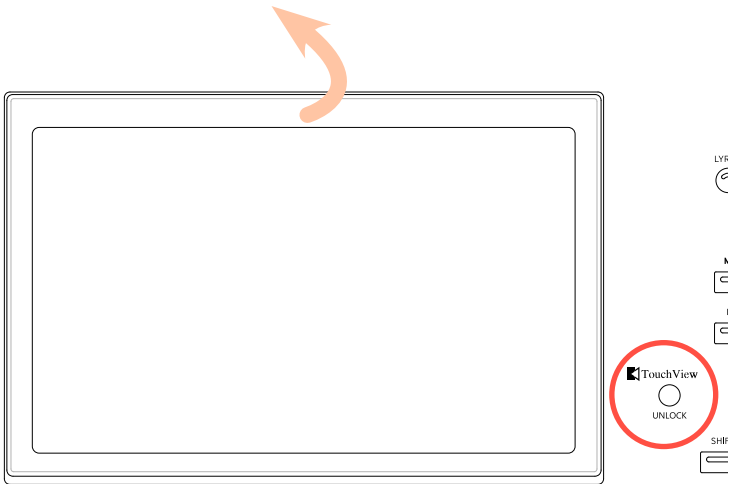

- 2 Keep the **UNLOCK** button pressed, and lift the display.
- 3 Open the safety bracket by detaching it from the top back of the display.

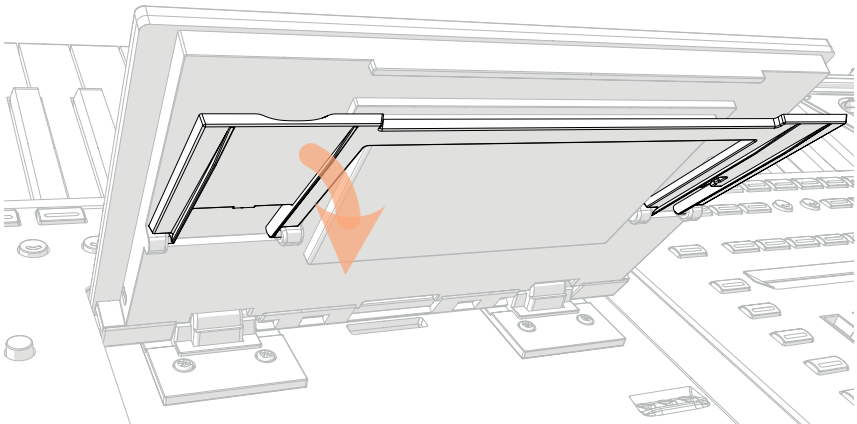

4 While still keeping the **UNLOCK** button pressed, adjust the tilt angle, and fix the bracket to one of the stops in the bottom of the display housing.

CAUTION: Do not apply excessive pressure, or you risk to break it!

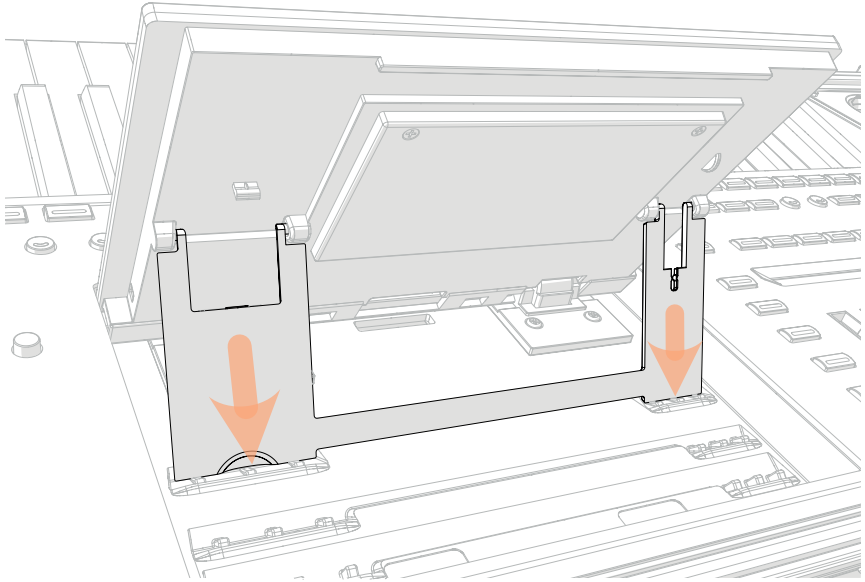

5 Release the **UNLOCK** button to fix the display to the current position.

Closing the display

- 1 Keep the **UNLOCK** button pressed, and lift the display.
- 2 Lift the safety bracket, and put it back to the closed position.

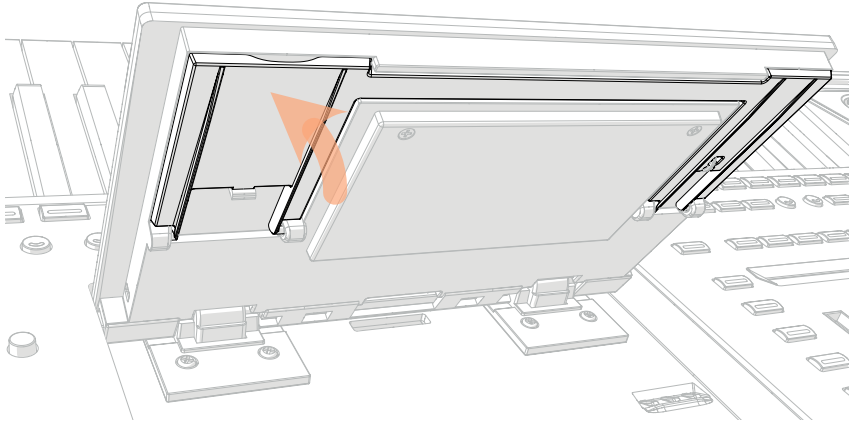

- 3 Still keeping the **UNLOCK** button pressed, accompany the display down to its housing.
- 4 Release the **UNLOCK** button, and gently press the center of the top border of the display to lock it in the initial position.

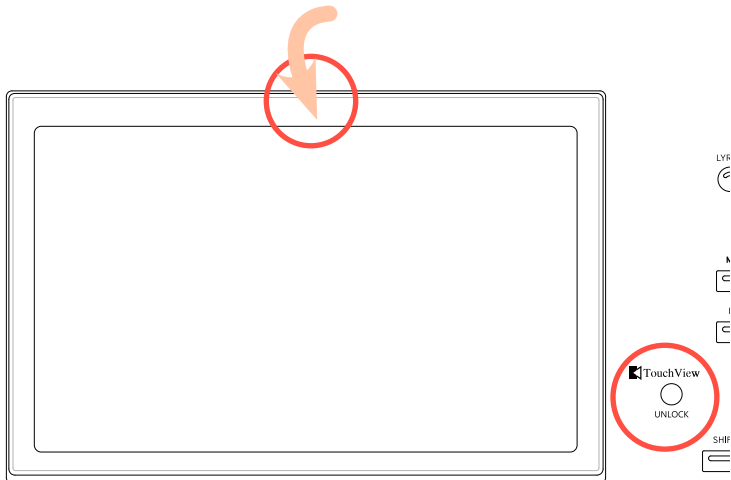

Adjusting the display brightness

The display brightness can be adjusted to match the ambient's light.

- > Keep the **SHIFT** and **MENU** buttons pressed, and use the **DIAL** to adjust the display brightness.

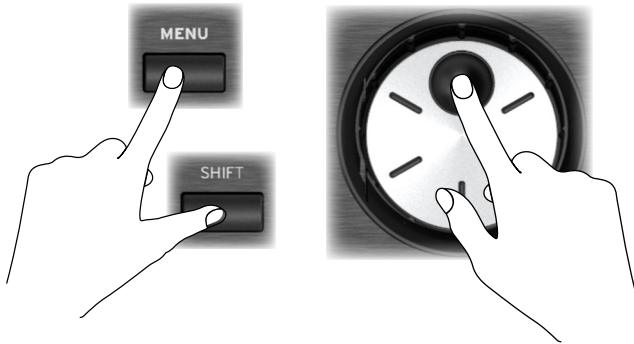

You can also adjust the display (and the strip display) brightness in the **Settings** > **General Controls** > **Interface** page.

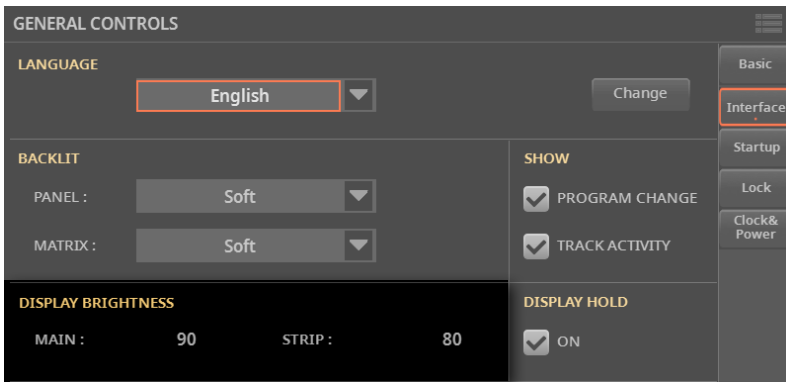

Listening to the Demo Songs

You can listen to some songs we prepared, to let you understand what this instrument can do.

■ Access the Demo mode

- > Press the **DEMO** buttons together.



■ Listen to all the Demo Songs

- > After accessing the Demo mode, do not press any button. All the Demo Songs will be played back.

■ Choose a single Demo Song

- > Touch one of the options on the display, then choose **one of the Demo Songs**.

■ Exit from the Demo mode

- > Press either of the **DEMO** buttons.

02

The User Interface

The Main page

Overview of the Main page

The **Main page** of the **Home mode** appears when turning the instrument on. You can return here by pressing the **EXIT** button while in any other page.

This page is where you can play with the accompaniment of Styles or Songs, use the Pads and the Matrix, sing with the vocal effects and play with your guitar through an amp simulator.

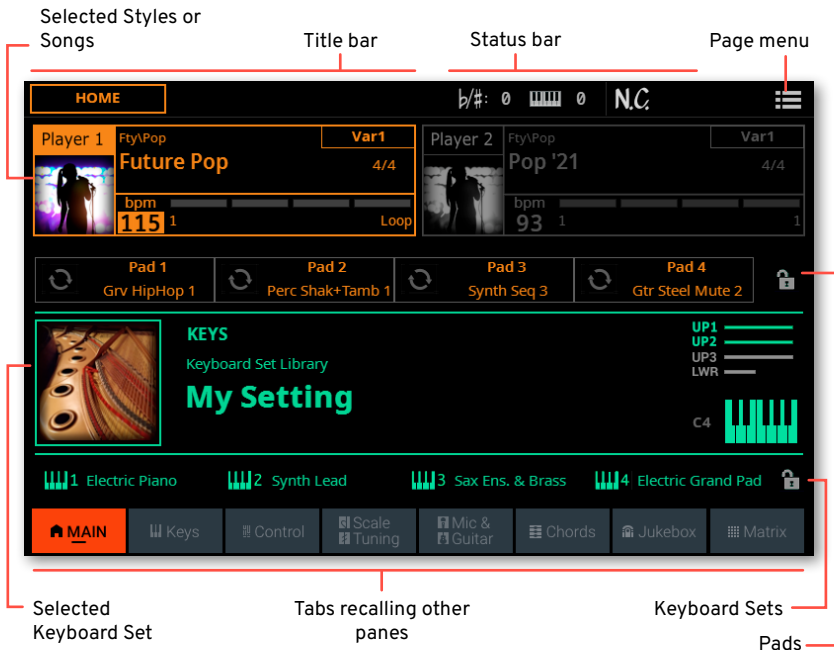

The Main page in detail

Title bar

The **Title bar** on the top left, showing the name of the section.



Status bar

The **Status bar** in the top center, showing the status of the master transpose, octave transpose, and the recognized chords.



Page menu

The **Page menu** on the top right, containing the commands with the operations for the current page.



Players

The **Players area**, where you can access the Styles and the Songs. **Player 1** (orange) is on the left; **Player 2** (blue) is on the right. You can mix between the two by moving the **X-FADER**.

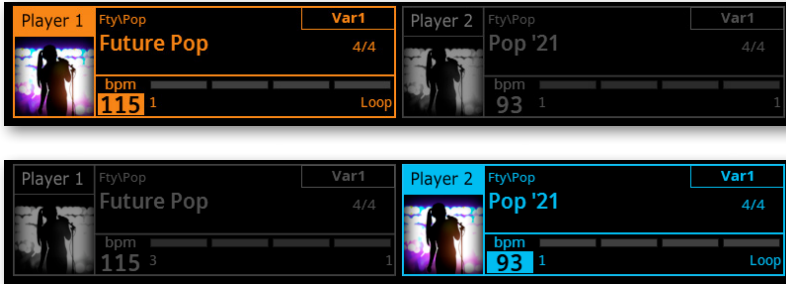

Pads

The **Pads area**, for playing **Loop-type** (↻) or **One Shot-type** (→) Pads. You can also play and stop them with the **PAD** buttons on the control panel, or in the dedicated mode of the **Matrix**. If you close the **padlock** (🔒), the Pads will not change.

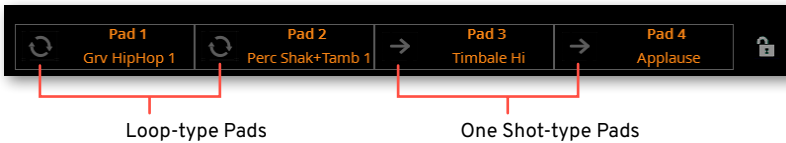

Keys

The **Keys area**, where you can see which set of sounds (Keyboard Set) is assigned to the keyboard. On the right you can see the split point, in case the keyboard is split in two parts.



Full Keyboard mode



Split mode, Bass&Lower mode on

Keyboard Sets

The four **Keyboard Sets** provided by the current Style or SongBook Entry. You can also select them with the four **KEYBOARD SET** buttons under the **X-FADER**. If you close the **padlock** (🔒), the Keyboard Sets will not change.



Tabs

The **tabs**, corresponding to a **pane** with dedicated parameters appearing in the lower side of the display.



The Home mode

The **Home mode** contains the **Main page**, but it also contains other ‘panes’ with important settings for your performance (the individual Sounds, the Control section, the Mic & Guitar Effects, the Chords, the Matrix options...).

Touch the **tabs**, at the bottom of the display, to see the corresponding **pane**.



You can access other settings useful for adjusting your playing and your sound (like the Mixer, the Effects, or the Chord Recognition options) by pressing the **MENU** button to make the **Home edit menu** appear. Touch one of the buttons to access the corresponding **edit section**.

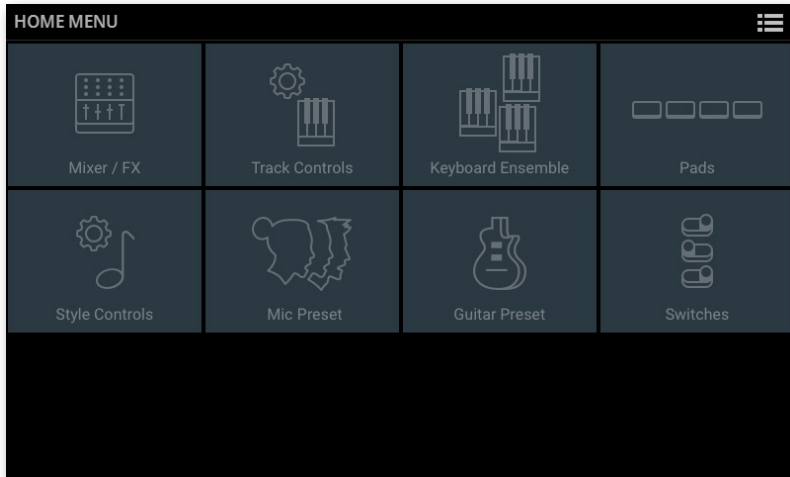

To save the various elements (Keyboard Sets, Styles, Chord Sequences...) and set some of the play options, choose a command from the **page menu** (☰).

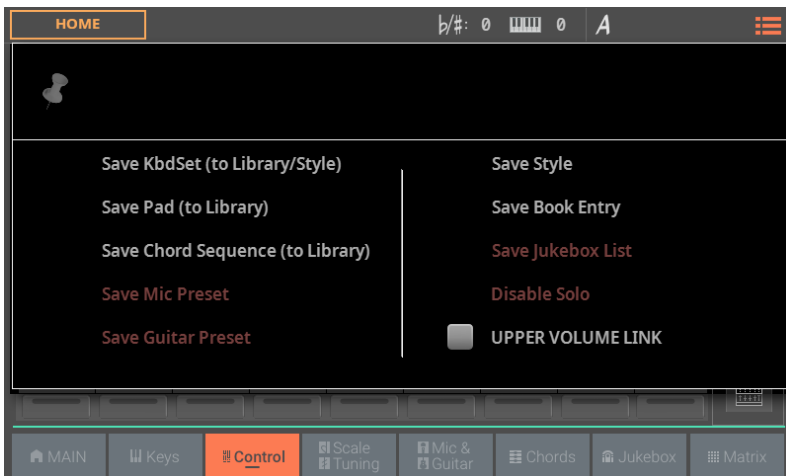

The File mode

The **File mode** is where you manage the files in the internal and external storage devices. You can access it by pressing the **FILE** button. You can exit it by pressing the **EXIT** or the **FILE** button again.

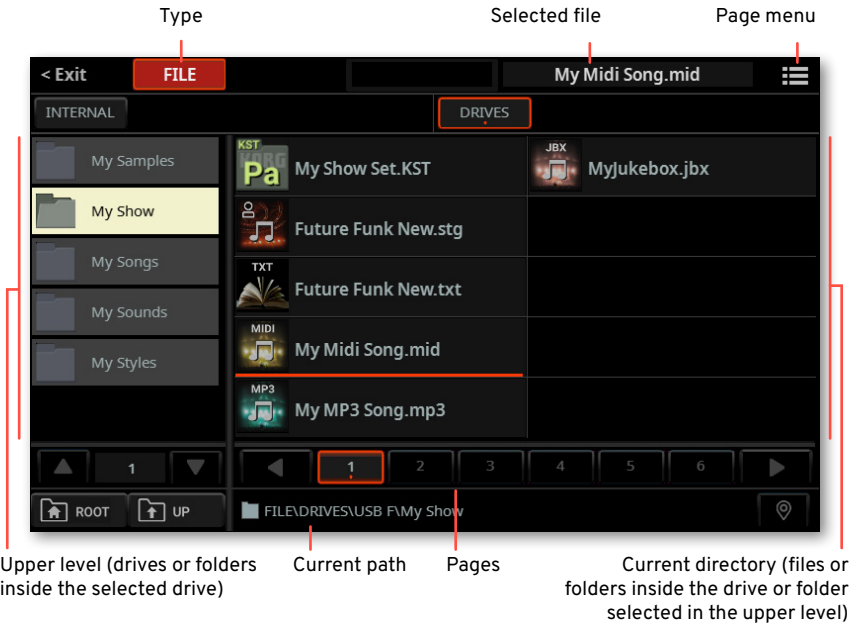

To perform operations on a device, folder or file, touch it, and then choose a command from the **page menu** (☰). In some cases you can select multiple files by keeping the **SHIFT** button pressed while touching them, and perform operations on multiple files.



You can access other File operations by pressing the **MENU** button to make the **File edit menu** appear. Touch one of the buttons to access the corresponding **edit section**.

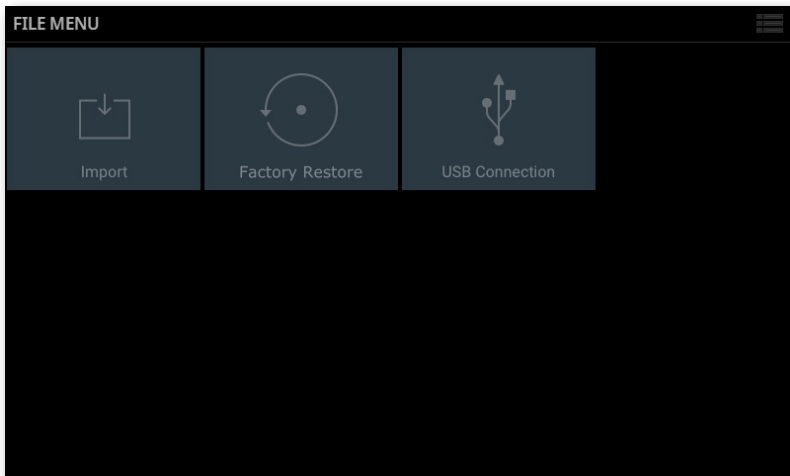

The Settings mode

The **Settings mode** is where you access the general settings and preferences, as well as elements that are common to all the modes. You can access it by pressing the **SETTINGS** button. You can exit it by pressing the **EXIT** or the **SETTINGS** button again.

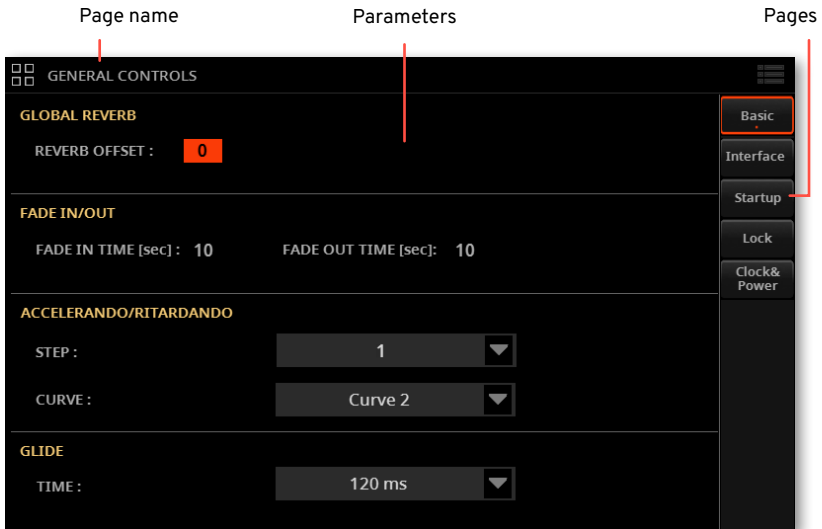

You can access the various general settings and preferences by pressing the **MENU** or **SETTINGS** button to make the **Settings edit menu** appear. Touch one of the buttons to access the corresponding **edit section**.

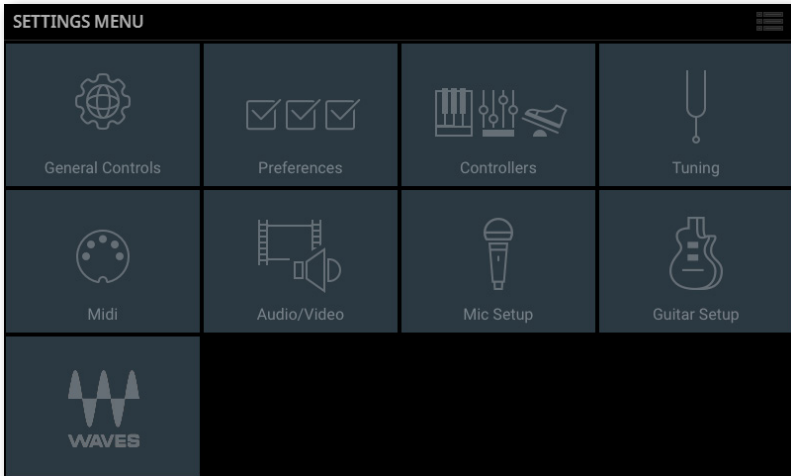

To save the element in edit, in some pages, choose the corresponding command from the **page menu** (☰).



The Record/Edit modes

The **Record/Edit modes** are where you can record and edit Sounds, Samples, Styles, Songs and Pads.

You can access these modes by pressing the **REC/EDIT** button, and choosing one of the modes. While in one of the Record/Edit modes, you can press the **MENU** button to browse through the various sections and pages, as you would do in the **Home** mode.

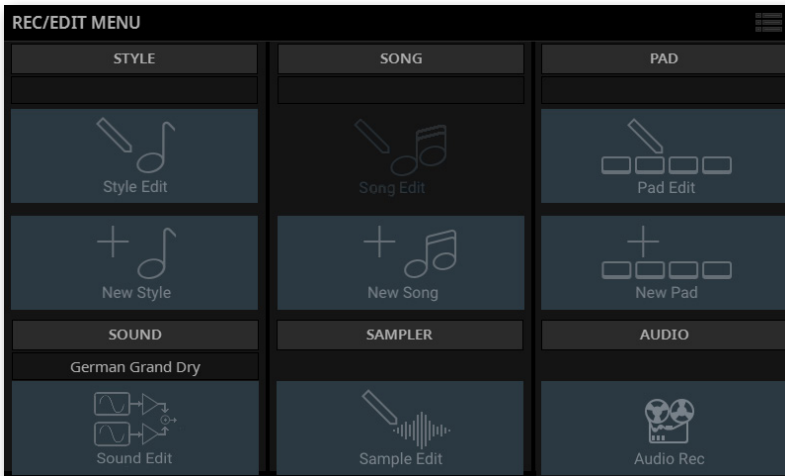

You can exit the **Record/Edit mode** by pressing the **EXIT** or the **REC/EDIT** button again.

Each of the **Record/Edit modes** is organized as the **Home mode**, with a **Main page** and **edit pages** you can access by pressing the **MENU** button. The following example shows the **edit menu** of the **Sound Edit mode**.

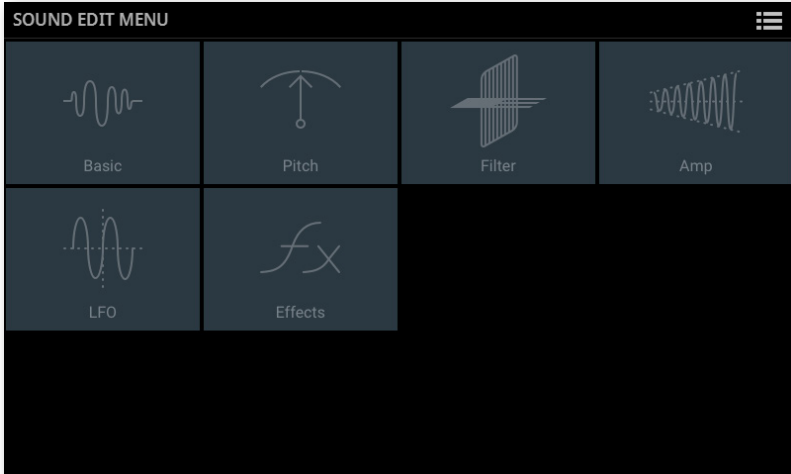

Each of the modes is organized in **edit pages**.

Page name Parameters Pages

BASIC SOUND: German Grand Dry b#: 0 0 N.C.

OSCILLATORS COUNT VOICE ASSIGN MODE

8 POLY SINGLE TRIGGER

LOW PRIORITY : 0 MONO Legato Off

TRANSPOSE RANGE HOLD PRIORITY : Last

TOP KEY : C9

BOTTOM KEY : C-1

SOUND CONTROLLERS MODE

SC1 : Booking SC2 : Booking SC3 : Booking Y+ : Booking Y- : Booking

LEGATO as OSC TRIGGER

MAX TIME : 200 ms MAX RANGE : 5 semitones

1 2 3 4 5 6 7 8 9 10 11 12

13 14 15 16 17 18 19 20 21 22 23 24

Sound

Oscillator

Velocity Range

Damper Mode

Damper Trigger

EQ

To save the element in edit and set some options, in some pages, choose the corresponding command from the **page menu** (☰).



The user interface in detail

Physical controls

Buttons

Many buttons include LED indicator lights. The simpler ones have an on/off red light over them. Others have multi-color lights, whose color changes depending on the corresponding function status.

Button with an on/off red indicator



Button with multi-color status indicators

Buttons and color coding

STYLE ELEMENTS buttons get different colors depending on the type of Element.

Style Elements	Color Code
Intro	Light Green
Variation	Dark Blue
Fill	Yellow-Green
Break	Purple
Ending	Dark Pink

MARKERS are shown in white when one of them is associated to a button. When one of them is selected, it takes the color of the current Player.

Markers	Color Code
Available	White
Non available	Off
Selected	Orange (Player 1) or Blue (Player 2)

The **MATRIX** buttons change depending on the selected Player. If no functions are assigned, a button remains dark.

Matrix	Color Code
Available	White
Non available	Off
Selected	Orange (Player 1) or Blue (Player 2)

In general, the selected button's color shows the current Player it is assigned to.

Current Player	Color Code
Player 1	Orange
Player 2	Blue

Modes, pages, panes and tabs

Modes

The user interface is organized in **pages**. Pages are organized in **modes**. Each mode is accessed by pressing the corresponding button on the control panel.

Edit menus and sections

The **edit pages** are grouped into **sections**. Sections are selected by touching the corresponding buttons in the **edit menu** that opens up when you press the **MENU** button.

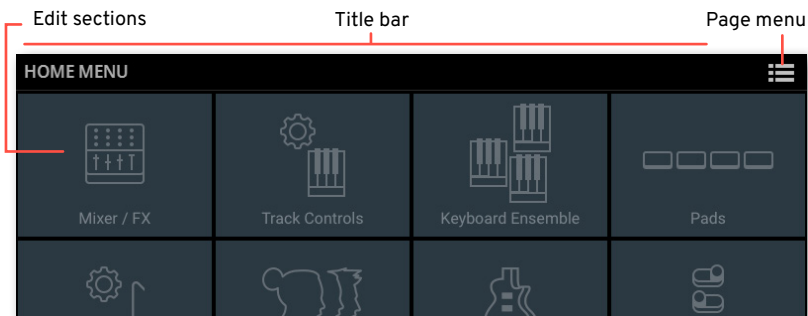

The name of the **current section** is shown in the **title bar**.

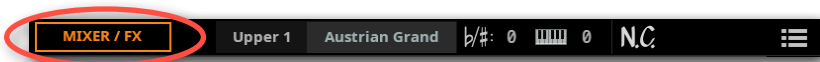

The **page menu** (☰) is context sensitive, and may vary depending on the page you are when you open it.

Pages, panes and tabs

Parameters are grouped into separate **pages**. You can select a page by touching the corresponding **tab** in the rightmost area of the display.

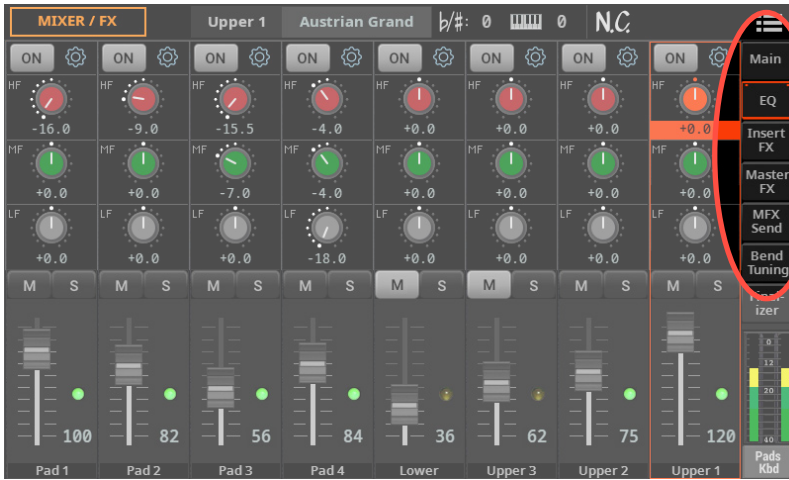

Some pages also contain **panes**, where only part of the page will change, leaving the top half unchanged. You can select a pane by touching the corresponding **tab** at the bottom of the display.

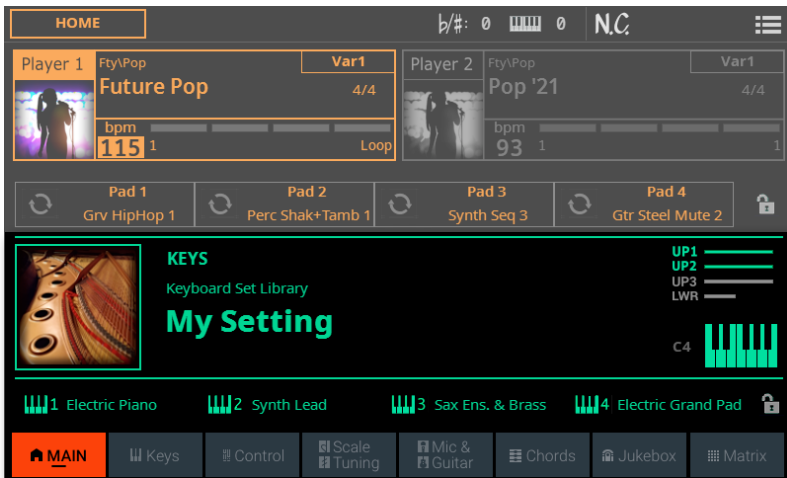

Normal and expanded view

Expanded view

Some panes can be expanded, to show more parameters. You can expand a pane by touching the **Expand** () button.



You can make the pane go back to the reduced size by touching the **Collapse** () button.



Windows, dialogs, messages

Overlapping windows

Some **windows**, like the **Select** ones, overlap the current page. If you press the **EXIT** button, or touch the **Exit** command in the upper-left corner or the window, the window closes, and the underlying page is shown again. If the **Display Hold** parameter is off, the window will close automatically after selecting an item (see [Display Hold](#) on page 67).

The following example is the **Keyboard Set Select** window.

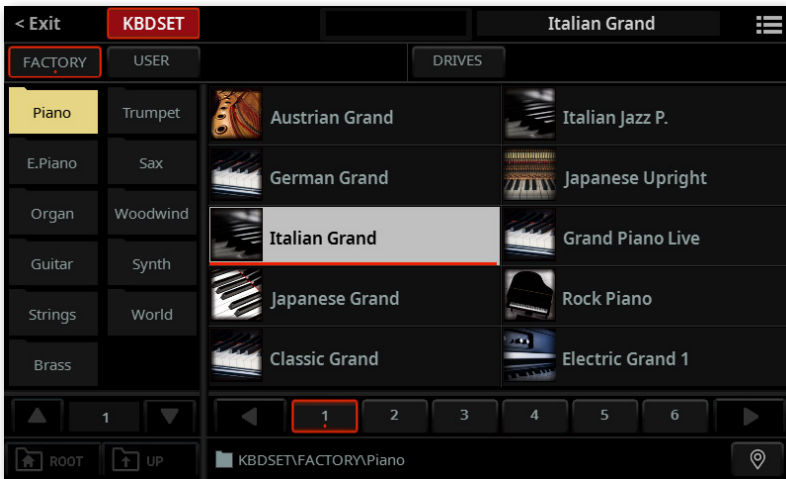

Dialogs

Similar to the **Select** windows, **dialogs** overlap the underlying page. Choose the options in the dialog (if any), then touch one of the buttons at its bottom to confirm your answer, and the dialog will close.

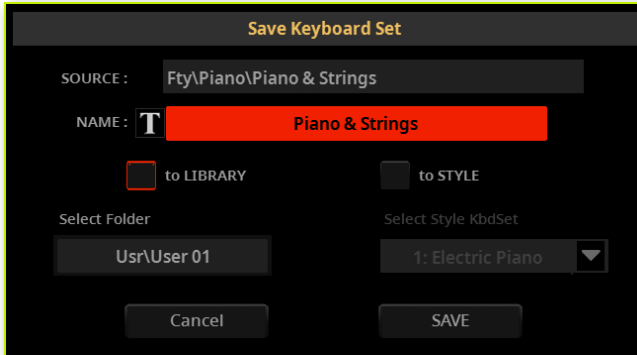

Messages

During an operation, you may see a **message** letting you know what it is happening and how long it will last. The message will close automatically at the end.

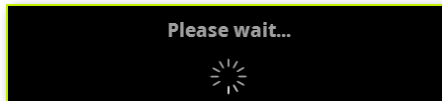

Menus and commands

Page menus

Touch the **page menu** (☰) icon in the upper right corner of each page, and a menu with commands relevant to the current page will appear.

Touch one of the available commands to select it. (Or, touch anywhere else on the screen to make it disappear, with no command selected).

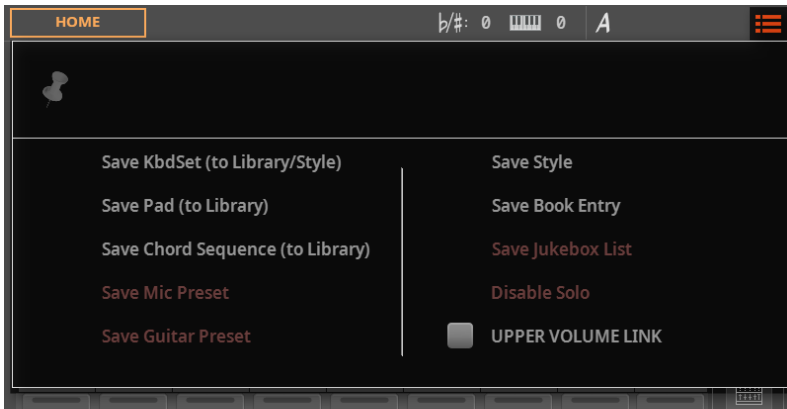

Pop-up menus

When a **down-pointing arrow** appears next to a parameter name, touch the arrow to open the **pop-up menu** containing a list of options. Choose an option by touching it. As an alternative, touch the parameter name and use the **DIAL** or **UP/DOWN** buttons to scroll the list of options.

If you want to make the menu disappear without selecting anything, touch anywhere else on the display.

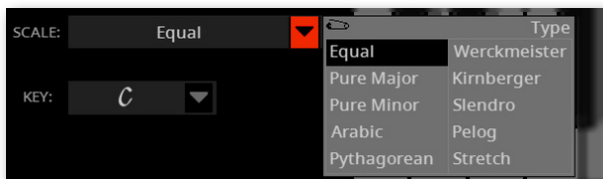

Lists

Lists and scrollbars

Songs in the SongBook, as well as other types of data, are shown as lists. Use the **scrollbar** to scroll the list content; you can touch in a direction, or touch and drag the scroll box. Also, you can use the **DIAL** or **UP/DOWN** buttons to scroll.

When the **Name** label is selected on top of a list, keep the **SHIFT** button pressed while touching one of the **arrows** on the scrollbar, to jump to the next or previous alphabetic section.

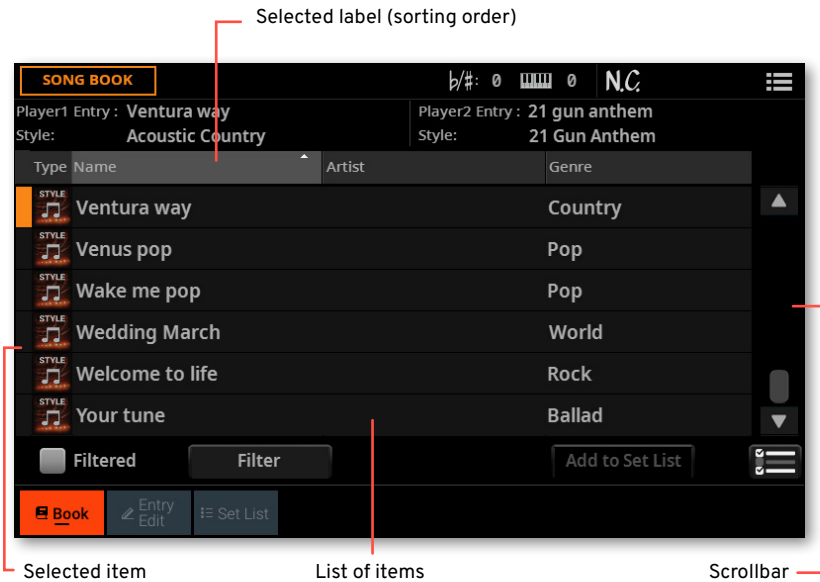

Parameters

On/Off buttons

These buttons turn the corresponding parameter or section on or off. Touch them to change their status.



Checkboxes

This kind of parameters are on/off switches. Touch them to change their status.



Selected, highlighted items

Any operation on parameters, data or list entries, is executed on highlighted items. First touch the parameter or item to select it, then execute the operation. Most parameters can be edited with the **DIAL** or **UP/DOWN** buttons.



Non-available, dimmed parameters

When a parameter or command is not currently available, it is shown dimmed on the display. This means it cannot be selected, but may become available when a different option is selected.

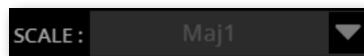

Text and numbers

Editable names

When the **Text Edit (T)** button appears next to a name, touch it to open the **Text Edit** window and edit the name.

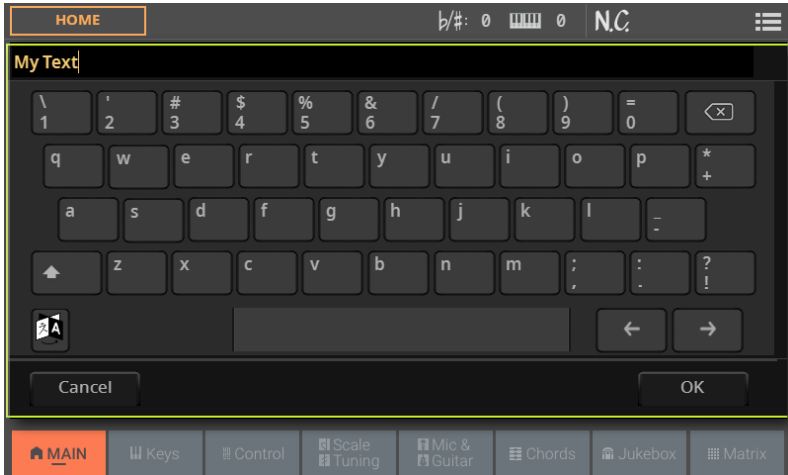

The **virtual keyboard** works exactly as a tablet's or a personal computer's keyboard. Some of the symbols are context-sensitive, and only appear when they can actually be used.

Some of the keys include additional characters. Keep a key pressed in the virtual keyboard, until a pop-up menu appears, and choose one of the alternative characters.



If you want to delete the full string, keep the **Backspace (X)** button pressed.

Numeric fields

When a numeric value can be edited, touch it a second time to open the **Numeric Keypad**.







The **virtual numeric keypad** works exactly as the numeric keypad of a personal computer.

As an alternative, touch a **numeric field** and keep it held. Then move your fingers up (or right) to increase the value, or move it down (or left) to decrease it.

This also includes the **Tempo numeric field** in various pages.

Icons

Various icons help identifying the type of a file, a folder, a Song. For example:

Icon	Meaning
	Folder (generic)
	Folder (Pa5X's KST)
	Style file
	MID file

Virtual controllers

Virtual sliders

To change a virtual slider's position, touch it and keep it held, then slide up or down to change its position. As an alternative, touch it, then use the **DIAL** or **UP/DOWN** buttons to change its position.

Depending on the status of the **CONTROL MODE** indicator in the control panel, the position of the virtual sliders might match that of the **SLIDERS**.

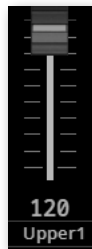

Virtual knobs

To change a virtual knob's position, touch it and keep it held, then slide your finger up (or right) to rotate it clockwise, or slide it down (or left) to rotate the knob counter-clockwise. As an alternative, touch it, then use the **DIAL** or **UP/DOWN** buttons to change its position.



Virtual drawbars

To change a virtual drawbar's position, touch it and keep it held, then slide it up or down to change its position. As an alternative, touch it, then use the **DIAL** or **UP/DOWN** buttons to change its position.

If the status of the **CONTROL MODE** indicator in the control panel is **DWB (DRAWBARS)**, the position of the virtual sliders matches that of the **SLIDERS**.

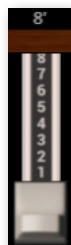

Going through the pages

How to read a page address

The operative modes contain edit pages, that are grouped into edit sections. In some case a page contains separate panes with additional data.

Through this manual, page addresses are shown as in the following example:

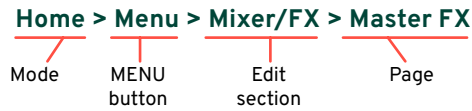

Going through the pages in Home mode

This is an example of how to reach a given page in the **Home** mode.

- 1 First of all, go to the **mode** containing the page or pane you are looking for. To return to the **Home** mode from any other page, press the **EXIT** button. When the instrument turns on, it is already in this page.

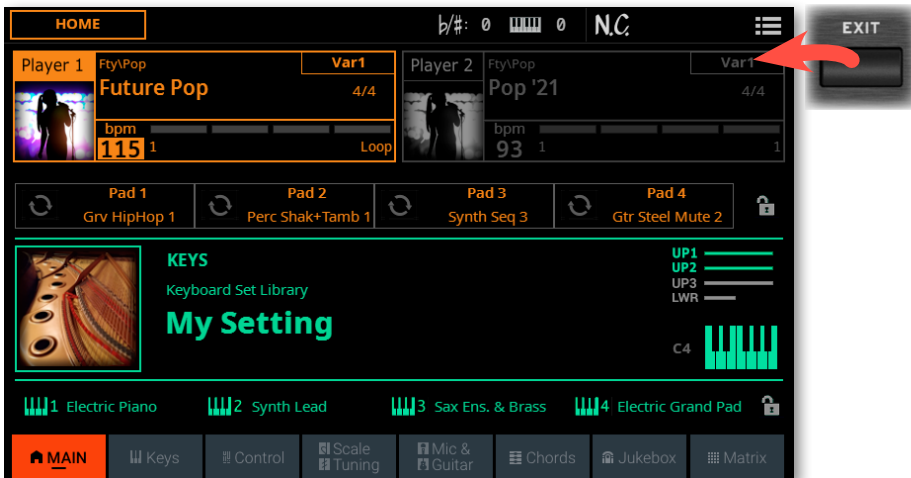

- 2 Touch the **tab** in the lower area of the display to select a different **pane**. For example, while in the **Home** page, touch the **Keys** tab to choose the **Keys** pane.

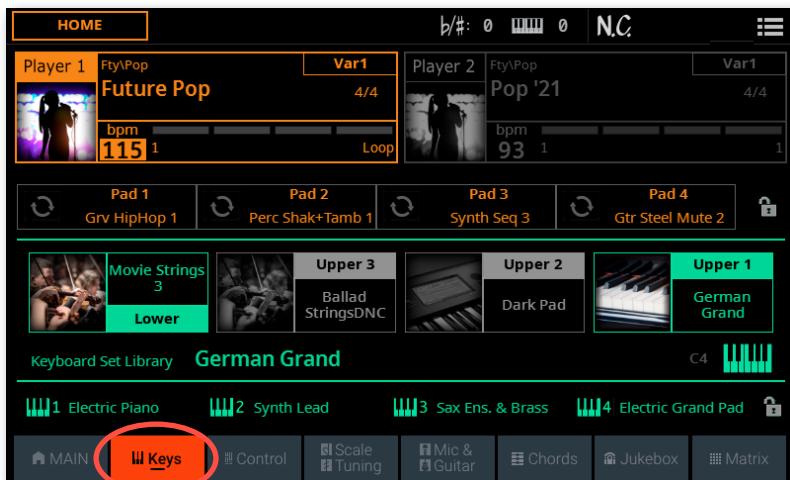

3 Press the **MENU** button on the control panel to see the **edit menu** of the **Home** mode.

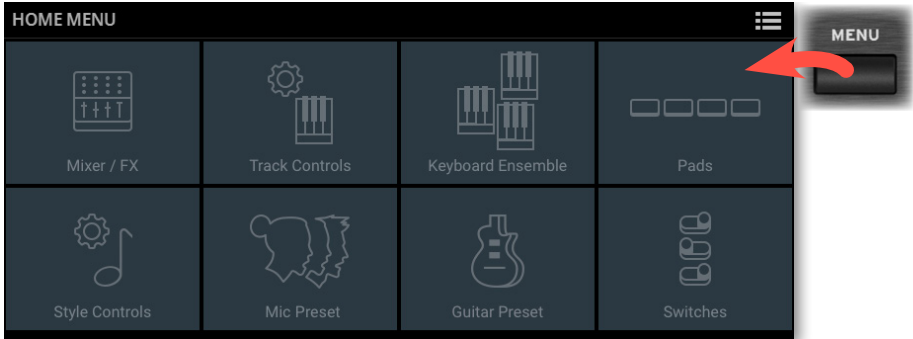

4 Touch the **Mixer/FX** button in the **edit menu** to choose the **Mixer/FX** section.



The selected **edit section** is always shown in the **title bar**:

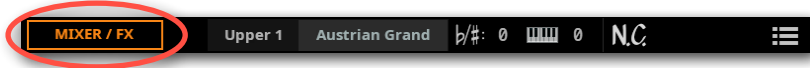

- 5 If the page is not yet shown in the display, touch the **Master FX** side tab to choose the **Master FX** page.



- 6 Edit the **parameters**.

- 7 Try a different page in the same edit section. Touch the **EQ** tab to go back to the **EQ** page, and edit the parameters.

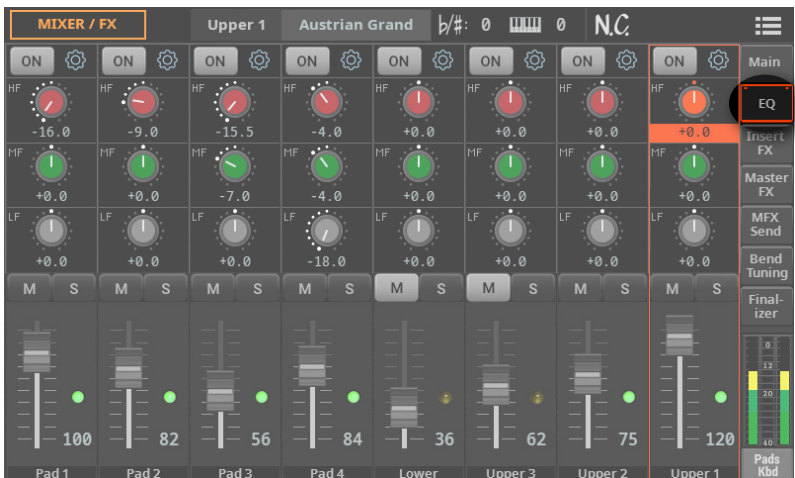

8 Press the **EXIT** button to return to the **Main page** of the **Home mode**.

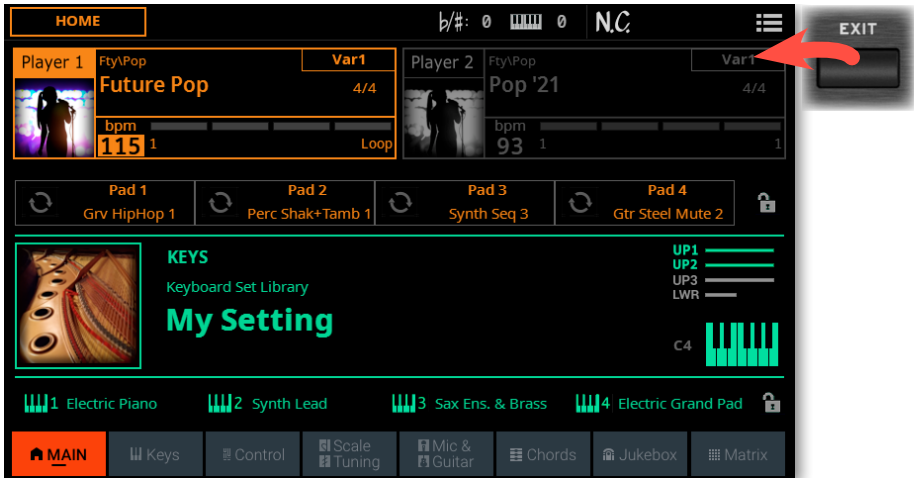

Going through the pages in Record/Edit mode

Navigating through the sections and page of the **Record/Edit** mode is the same as in the **Home** mode. There is an added layer, consisting in first selecting the **Record/Edit** mode.

1 From the Home page, press the **REC/EDIT** button to see the **edit menu** of the **Record/Edit** mode.

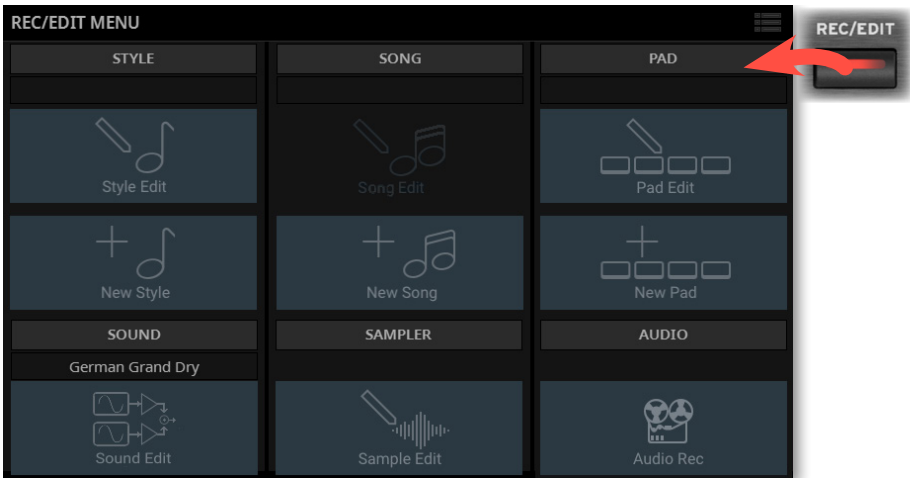

2 Touch one of the **Record/Edit** section buttons in the **edit menu** to choose the corresponding section.

3 While in one of the **Record/Edit** pages, you can press the **MENU** button to go through the edit pages of that mode.

4 While in one of the **Record/Edit** pages, pressing **EXIT** a first time returns to the **Main page** of the current **Record/Edit** mode.

5 To exit from the **Record/Edit** mode and return to the **Home** mode, press the **EXIT** or the **REC/EDIT** button again.

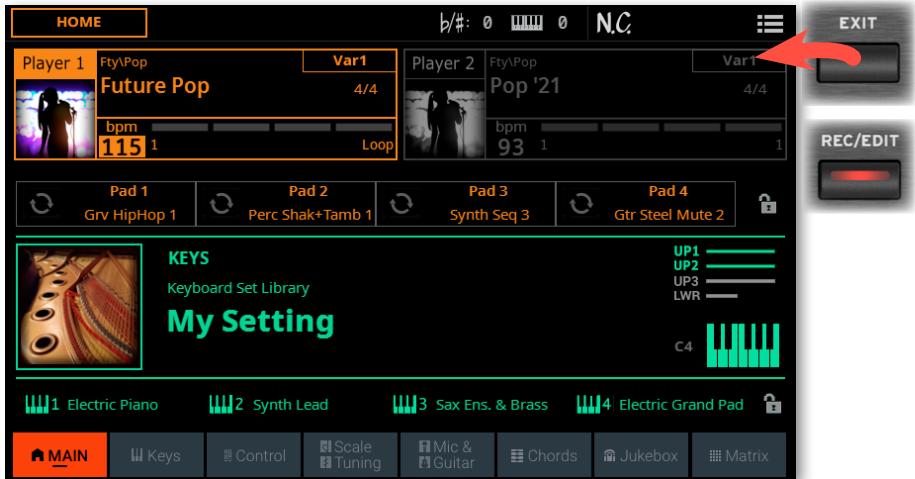

Choosing the musical resources

Opening a Select window

When you press the **STYLE**, **SONG**, or one of the **KEYBOARD SET LIBRARY** buttons, the corresponding **Select window** appears.

The **Select window** can also be opened by touching the name of the corresponding element (Style, Song, Keyboard Set, Voice or Guitar Preset...) in the display.

Touch to choose a Style or Song

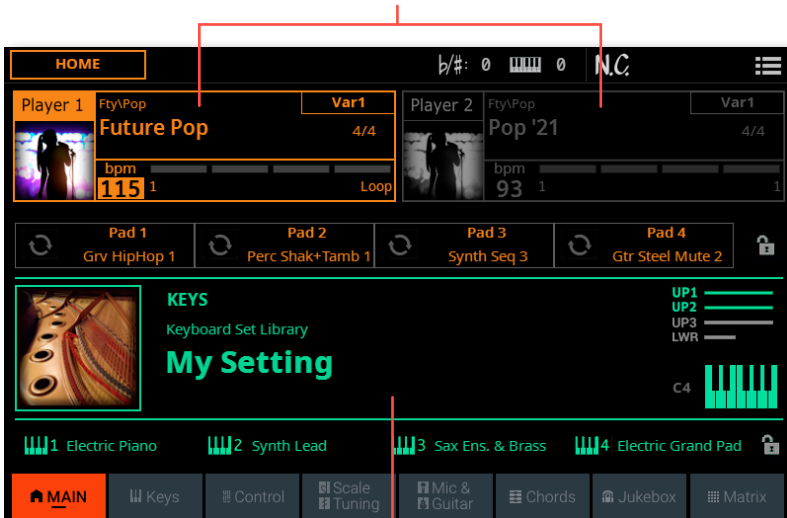

Touch to choose a Keyboard Set

For example, this is the **Select** window when browsing for a Keyboard Set:

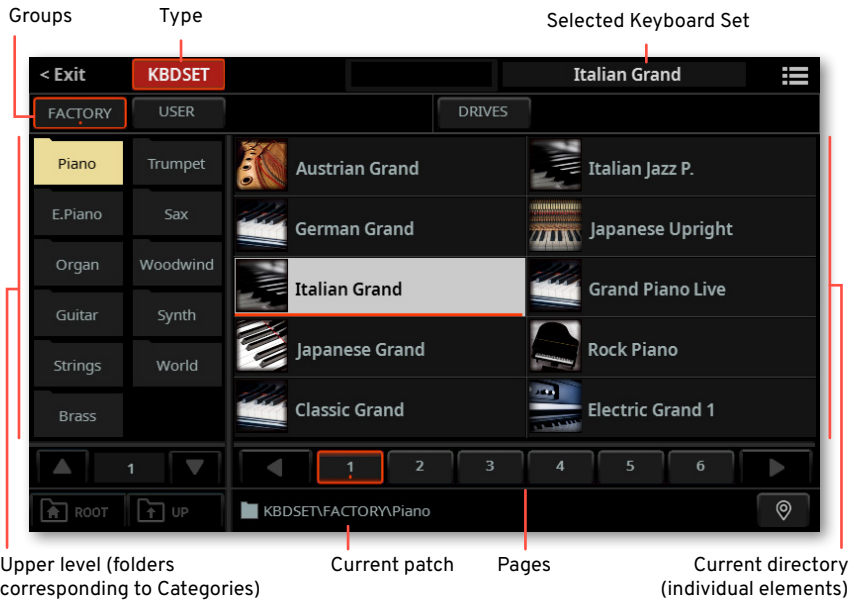

If you are lost while browsing through the data, you can return to the folder containing the selected element by touching the **Locate** (📍) button.

You can always exit from this window by pressing the **EXIT** button, or by touching the **Exit** command in the top left corner of the display.

Select windows stay open until you press the **EXIT** button or touch the **Exit** command. If you prefer they automatically close after a few seconds, or after you select something, turn the **Display Hold** parameter off (see **Display Hold** on page 67).

The Select window in detail

These are the individual sections of a **Select** window.

Title bar

The **title bar**, showing the **type** of element you are going to select on the left, and the **selected element** on the right. It also contains the **page menu icon** (☰).

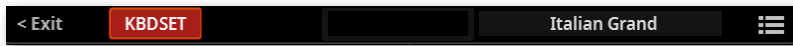

Group stripe

The **group** stripe, where you can select from **Factory** elements (supplied by KORGE), **User** elements (your own custom elements in the internal memory), and **Drives** (custom elements read directly from an external storage device, including removable ones).



Upper level (containing drive or folder)

The **upper level**, in the left side of the display, usually containing a list of **drives** or **folders**. Touch one of them to see its content in the right side of the display.

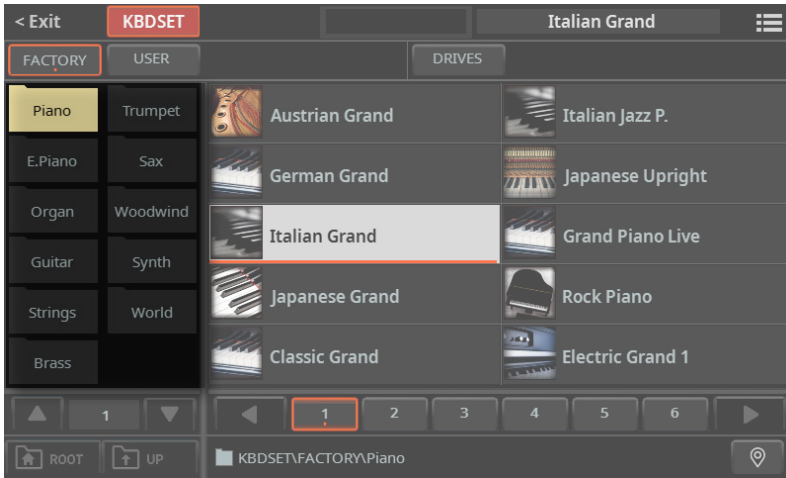

Under it, you can see the page number selector. Scroll through the different pages, if the folders are too many to fit in a single page.

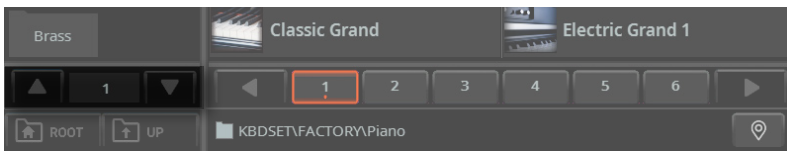

Lower level (current directory)

The **lower level**, showing the **current directory**, usually containing individual elements contained in the folder you touched in the first level. You can immediately select an element by touching it.

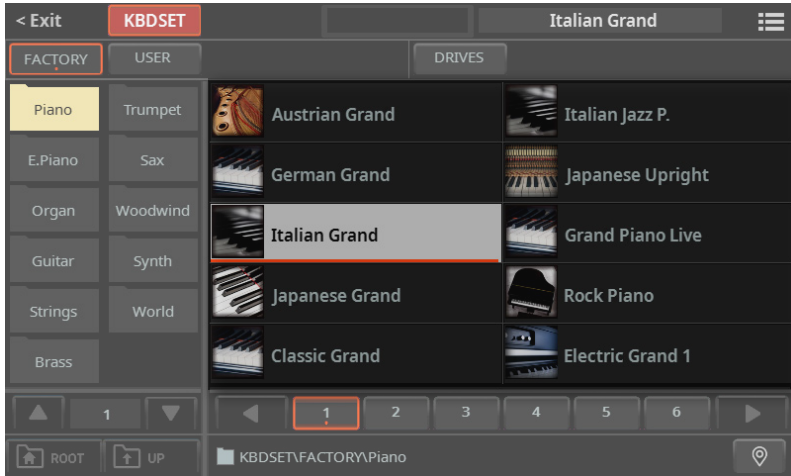

Under the elements, you can see the **page number selector**. Scroll through the different pages, if the elements are too many to fit in a single page. You can touch a **page number** to select it. If the pages are more than the ones that can be contained in the list, use the **left/right arrows** to scroll them in the display. Or use the **DIAL** or **UP/DOWN** buttons to move through the pages.

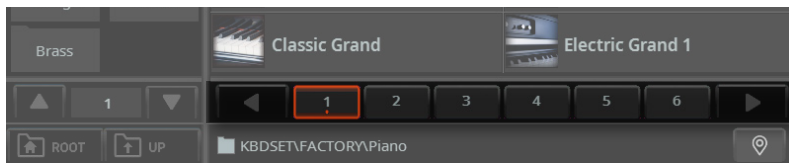

The **lower level** shows the **current directory**, and may also contain folders. If so, touch one of the folders to see its content. The content of the **lower level** will be moved to the **upper level**.

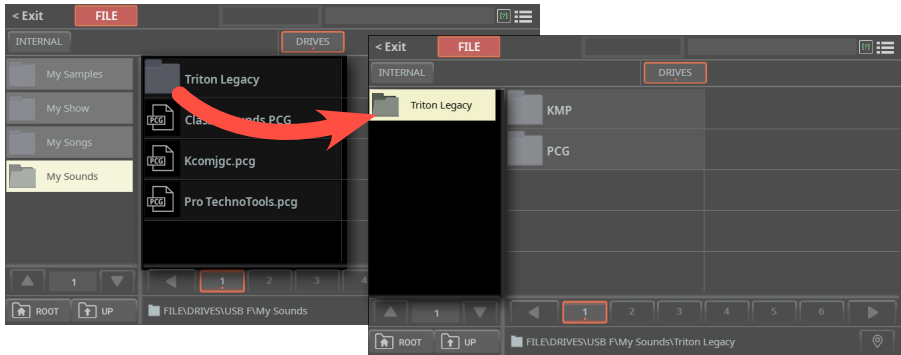

You can return to the containing folder by touching the **Up** button.

File path, Up, Root

The **file path**, where you can see the position of the selected item in the storage device or the internal memory.

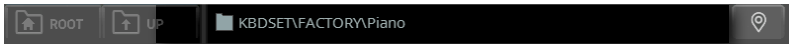

You can go to the parent folder at the upper level by touching the **Up** button, or to the top level of the drive by touching the **Root** button.

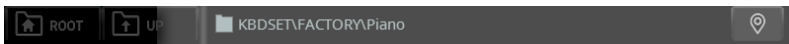

Locate button

If you are lost while browsing through the data, you can return to the folder containing the selected element by touching the **Locate** (📍) button.

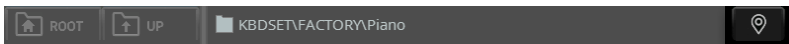

Display Hold

You may prefer to leave a **Select** window open after you have done your choice, maybe to continue trying other elements in that window. Or, you may prefer to let it automatically close after you have completed your choice. This depends on the **Display Hold** parameter.

Here is how to turn the Display Hold parameter on or off.

- 1 Go to the **Settings > Menu > General Controls > Interface** page.

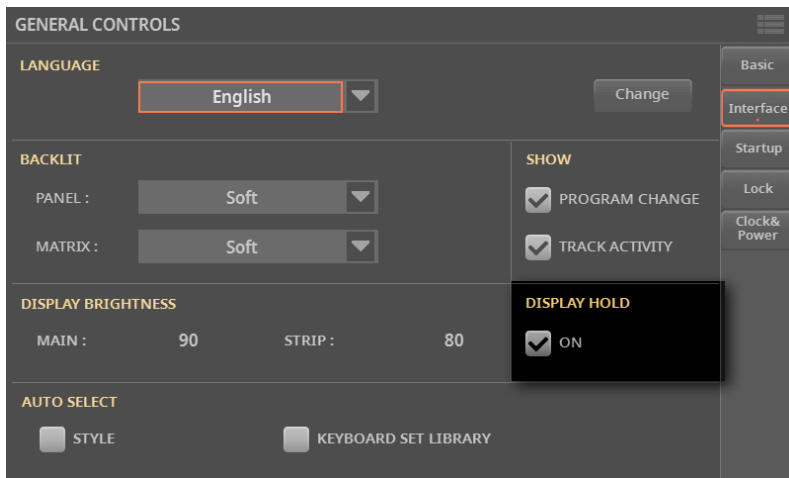

- 2 Turn the **Display Hold** parameter on or off:
 - > Select the **On** checkbox to turn it on. All **Select** windows will remain open on the display, until you press the **EXIT** button.
 - > Deselect the **On** checkbox to turn it off. All **Select** windows will automatically close after you have chosen an element.
- 3 Press the **EXIT** button to return to the previous page.

The Player and the Tracks

Styles, Songs and the Players

You can play a Style or a Song with either Player 1 or Player 2. Therefore, if you want, you can assign a Style or Song to each of the players, and have the other player be ready for the next musical selection. You can also mix Styles and Songs with the different Players.

You can choose which Player has the focus by moving the **X-FADER**, or by pressing the corresponding **PLAY/STOP** (▷◻) button when both Players are stopped.

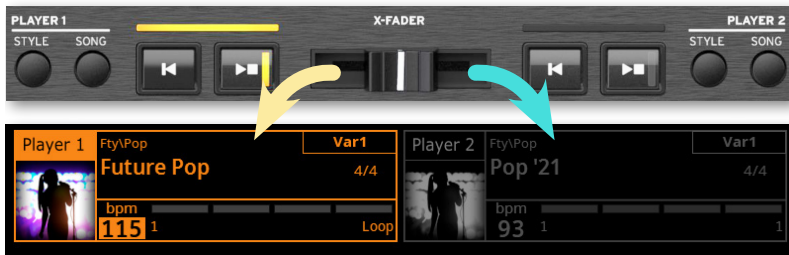

Keyboard, Style, Song and Pad tracks

The Sounds are assigned to Keyboard, Style, Song, or Pad tracks. You can see eight of them at a time in the display.

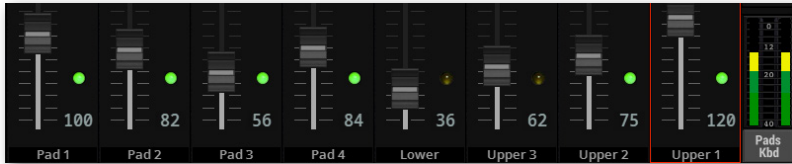

Which track is shown can be seen in the track's label at the bottom of the page.

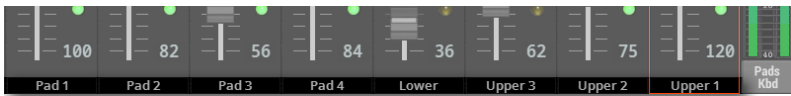

By touching the **TRACK SELECT** button next to the tracks, you can switch to a different group of eight tracks. Which one are displayed depends on the current elements (Keyboard Sounds, Pads, Style, Song).

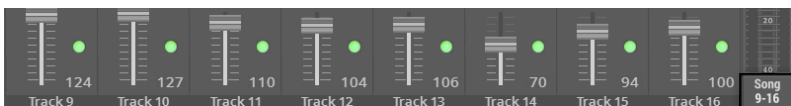
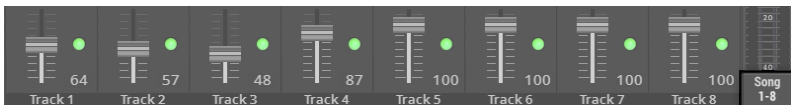
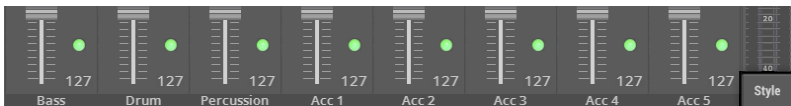
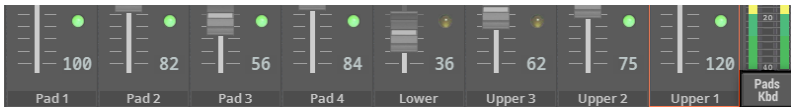

Saving the musical resources

Pa5X allows you to edit most of its data. Changes can then be saved into the **User** area of the internal memory (never the **Factory** area, that is protected), or in the **Settings** area.

Saving the Settings

Most of the changes you make in the **Settings** mode (the one you access by pressing the **SETTINGS** button) are automatically saved. There is no need to save them after editing.

Saving changes to Keyboard Sets, Styles, MIDI Songs and Pads

When you do some changes to the sounds, the effects and the various parameters of a Keyboard Set, a Style, a MIDI Song or a Pad, you can save them by choosing the corresponding **Save** command from the **page menu** (☰), while in one of the **Home** pages.

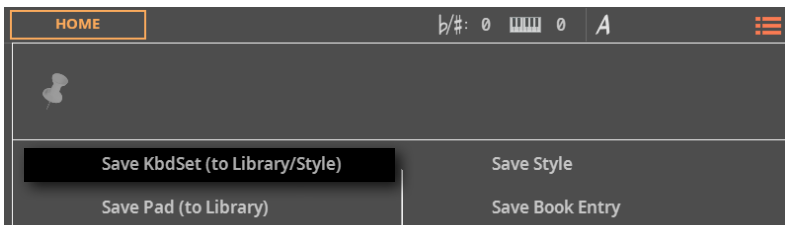

Saving changes to Mic, Guitar and MIDI Presets

When you do some changes to a Mic, Guitar or MIDI Preset, you can save them by choosing the corresponding **Save** command from the **page menu** (☰), while in one of their **edit** pages.

Saving other types of data

You can edit and save Styles, MIDI Songs, MP3 Songs, Chord Sequences, Sounds, Samples, Audio Loops, Effects for the Sounds. You can save them by choosing the corresponding **Save** command from the **page menu** (☰), while in one of their **edit** pages.

03

Playing the Sounds

The Keyboard Sets

Keyboard Sets and the Sounds

Keyboard Sets are what you play on the keyboard. They can be individual sounds, or rich ensembles of timbres split or layered across the keyboard.

Individual timbres are called the **Sounds**. Pa5X contains timbres from any instrumental family (pianos, strings, synthesizers...). A set of Sounds playing together on the keyboard can be memorized as a **Keyboard Set**.

To automatically recall sounds with all their settings (effects, transposition, and so on) you select a Keyboard Set.

Keyboard Set

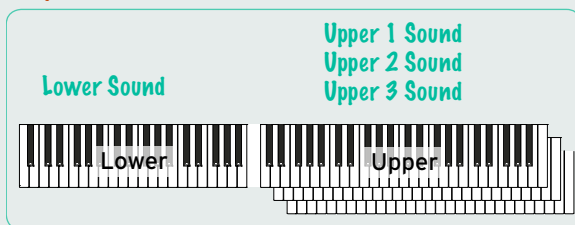

Keyboard Sets are individually contained in the Keyboard Set Library (**KEYBOARD SET LIBRARY** buttons). For your convenience, a group of four perfectly matched Keyboard Sets is automatically assigned to the four **KEYBOARD SET** buttons under the X-FADER, each time you select a Style or SongBook Entry.

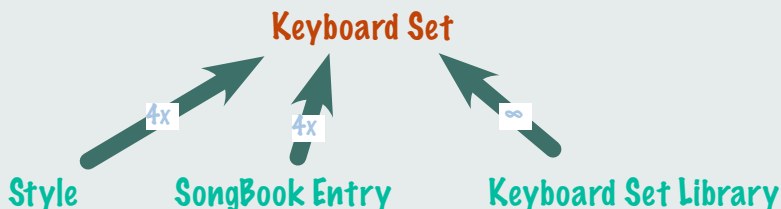

When choosing a Style or SongBook Entry, the Keyboard Set may be automatically recalled depending on the status of the **Style to Keyboard Set** function (see page 142). If you want this to happen, turn this function on. By default, you can turn it on or off by using **BUTTON #8** when the **CONTROL** section is in **USER** mode.

Choosing your preferred Keyboard Set

Choosing the 'My Setting' Keyboard Set

- > Press the **MY SETTING** button to choose your preferred sounds.

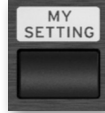

The My Setting Keyboard Set

My Setting is a special Keyboard Set, where you can save your preferred settings for things like sounds and effects to be played on the keyboard, and programming for control sliders, buttons, and the assignable switches. This Keyboard Set is automatically chosen when the instrument is turned on, and will automatically configure the instrument for you.

You can save here your preferred Keyboard Set. Keep the **MY SETTING** button pressed for about one second, until the **Save** dialog appears, then touch the **Save** button to confirm saving to memory.

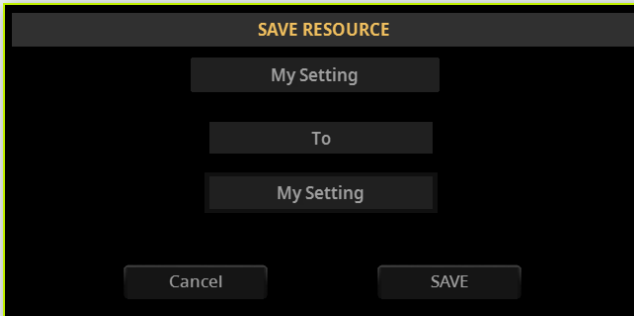

Choosing a Keyboard Set from the library

Keyboard Sets are contained in a dedicated library, that you can access from the control panel or from the display.

■ Open the Select window from the control panel

1 Use the **CATEGORY/FAVORITE** button to choose the type of Keyboard Set you want to select.



Type	Meaning
Category	The full database of Keyboard Sets contained in the Library. You can browse between the categories.
Favorite	A selection of your preferred Keyboard Sets, that can be accessed by pressing a single button.

2 Press one of the buttons of the **KEYBOARD SET LIBRARY** section. The selected button's light indicator will turn green.

You will notice that each of them has an **instrument family name** (Piano, E.Piano...) printed over it. Under the buttons, you will see the number corresponding to the Favorite Keyboard Set (1-11).



■ Open the Select window from the display

- > While in the **Main page**, touch the **name of the selected Keyboard Set**. You can touch anywhere in the Keyboard Set area.

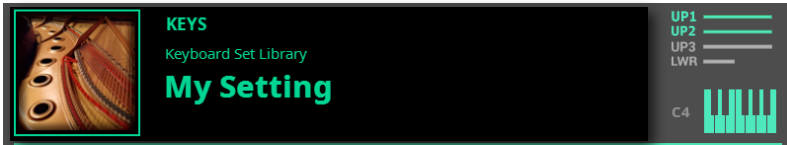

As soon as you press the button or touch the display, the **Keyboard Set Select** window appears.

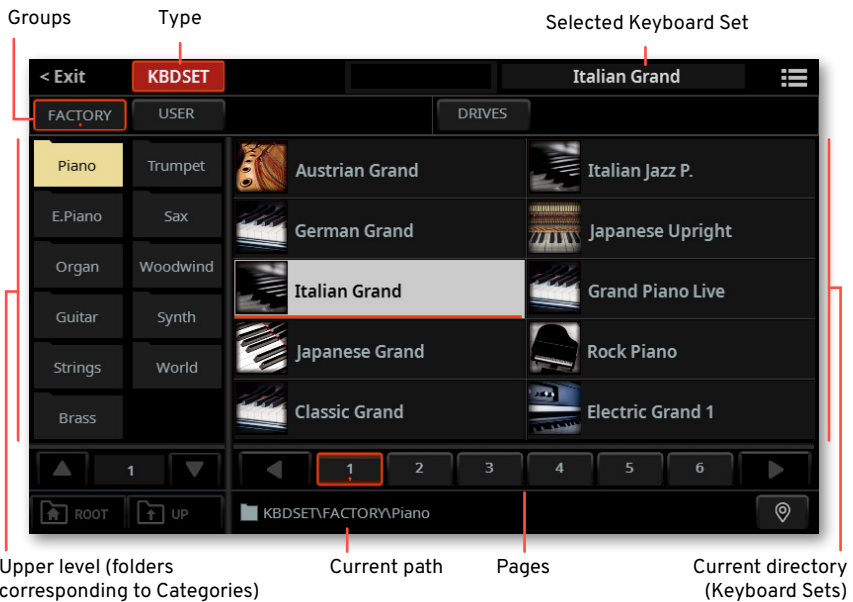

■ Choose a Keyboard Set

1 To choose one of the available groups from which to choose a Keyboard Set, touch the **buttons** in the second line at the top of the window.



Group	Meaning
Factory	Keyboard Sets included at the factory, that can't be modified or overwritten.
User	Internal memory area where you can save new or edited Keyboard Sets, or where you can copy Keyboard Sets from an external storage device.
Drives	Keyboard Sets accessed from an external storage device. You can organize them freely, as if they were ordinary files.

2 If you are choosing from the **Drives**, choose one of the available **storage devices (drives)**, in the left side of the display, then browse through the folders inside the **selected drive**.

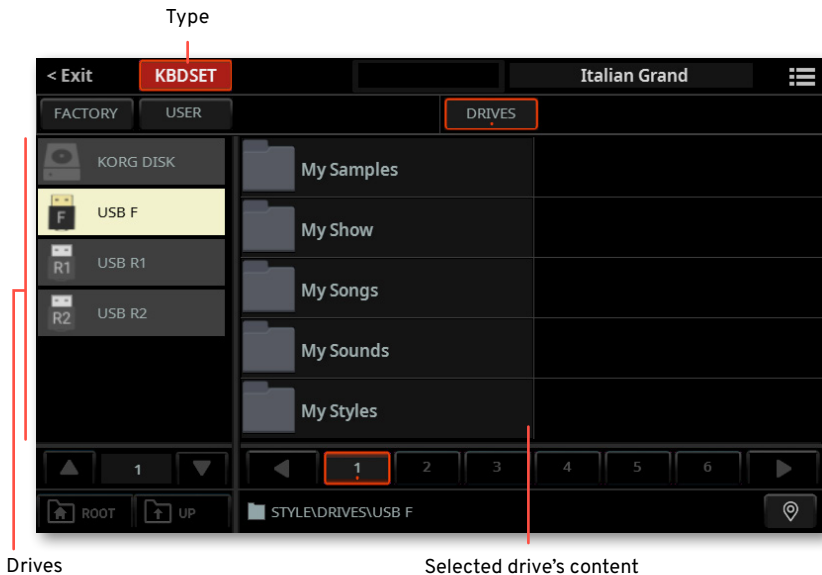

Drive	Meaning
KORG DISK	Storage space inside the internal drive (separate from the User area)
SD USER	Storage space inside the (optional) SD card
USB F	Storage device connected to the front USB HOST port
USB R1	Storage device connected to the rear USB HOST 1 port
USB R2	Storage device connected to the rear USB HOST 2 port

3 If you are choosing from the **Factory** or **User** banks, you will find the Keyboard Sets organized in **categories** (shown as folders). If you want to choose a different category, touch one of the category folders in the left side of the **Keyboard Set Select** window.

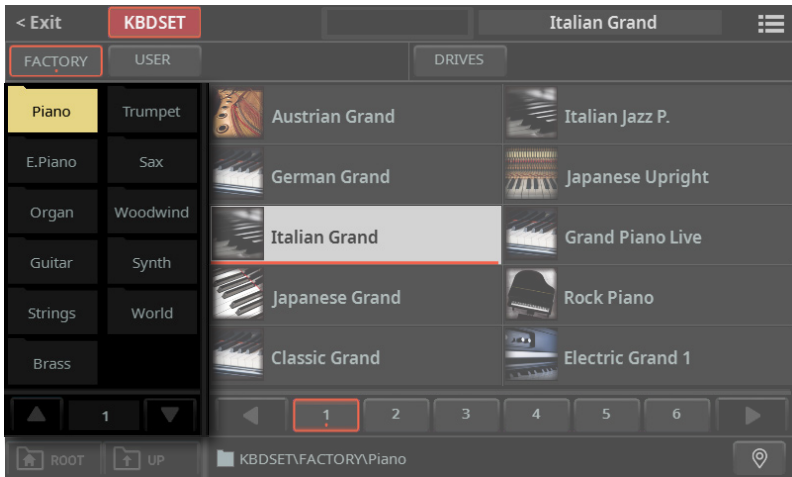

4 The Keyboard Sets contained in the selected folder appear in the right side of the window.

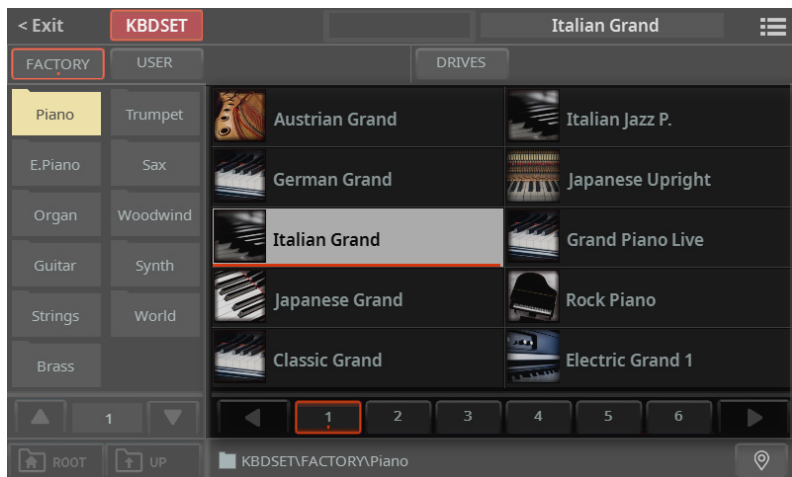

5 If the selected category folder contains more elements than the ones that can be seen in a page, choose the other pages. You can repeatedly press the same **button** in the **KEYBOARD SET LIBRARY** section to cycle through the pages.



6 If you are lost while browsing through the data, you can return to the folder containing the selected element by touching the **Locate** (📍) button.

7 Touch the **name of the Keyboard Set** you want to choose.

8 If you want to close the **Select** window (and it does not close by itself), press the **EXIT** button.

HINT: When a window does not close by itself, it means the **Display Hold** option is turned on. See [Display Hold](#) on page 67.

In the end, you will see the name of the selected Keyboard Set in the dedicated area of the **Main** page. The sounds assigned to the keyboard will change.

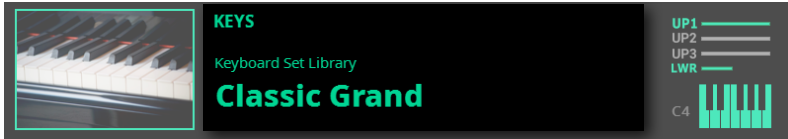

Digital Drawbars

You will notice that some Keyboard Sets in the Organ group of the library contain the ‘DWB’ abbreviation in their name. These Keyboard Sets contain Digital Drawbars Sounds, that are simulations of electro-mechanical organs of the past.

When you choose one of them, choose the **DRAWBARS** mode in the **CONTROL** section. Then use the **sliders** to control the drawbars and the corresponding footage of the organ sound; and use the **buttons** to control the classic drawbar organ features, like the amp rotation speed and the overdrive.

Factory, User, Drives

Across the pages, you will find words like Factory, User, Drives. These terms refer to the type of protection from saving, or how much you can customize them.

- > **Factory** are elements that you can’t overwrite or modify. They are meant to warrant that musical resources (like SongBook Entries) will always find linked musical resources (like Styles).
- > **User** are elements that you can save, modify or overwrite. User Keyboard Set and Pad categories can be renamed to create your own categories.
- > **Drives** indicate groups of User elements that you can directly access as ordinary files from a storage device (including external ones).

Choosing a Keyboard Set from a Style or a SongBook Entry

There are four matched Keyboard Sets in each Style or SongBook Entry, fine-tuned for the containing Style or SongBook Entry. You can choose them from the control panel or from the display.

Choosing a Keyboard Set from the control panel

- > Press one of the buttons in the **KEYBOARD SET** section under the X-FADER.



Choosing a Keyboard Set from the display

- > While in the **Main page**, touch one of the **Keyboard Set names** to select it. The Sounds assigned to the keyboard will change.

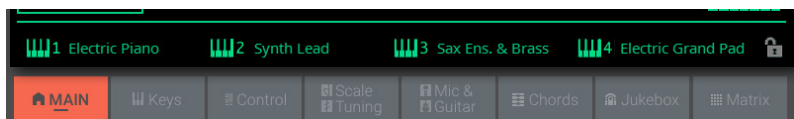

Letting the Style choose Keyboard Set #1

When choosing a Style or SongBook Entry, the Keyboard Set may be automatically recalled depending on the status of the **Style to Keyboard Set** function.

■ Access the Style to Keyboard Set function from the control panel

- 1 Press the **USER** button in the **CONTROL** section.



- 2 Check if the **strip display** is showing the functions assigned to the buttons. If not, you may want to press the **VIEW** button in the **CONTROL** section to see them.



■ Access the Style to Keyboard Set function from the display

- > Go to the **Home > Control > User** pane.

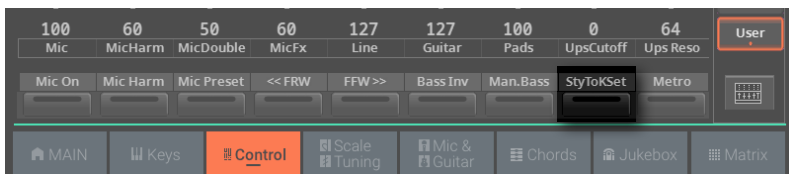

■ Turn the Style to Keyboard Set function on or off

> Repeatedly press (or touch) the **Style to Keyboard Set** switch to set the function.

Style to Keyboard Set indicator	Meaning
Off	Styles don't select a Keyboard Set.
On	When choosing a Style, Keyboard Set #1 is automatically selected.
Blinking	Choosing a Variation automatically recalls the corresponding Keyboard Set (1 - 4) inside the Style. For example, choose Variation 2, and Keyboard Set 2 will be automatically recalled; choose Variation 3, and Keyboard Set 3 will be automatically recalled.

Playing and controlling the sound

Playing the keyboard

The instrument's keyboard is like a piano keyboard. Just play it!

With some Sounds, you can press the keys while they are already down, and the sound might vary (for example, you might hear more vibrato).

Using the pedals

Pedals do different things depending on how they are programmed. The **Damper** pedal is precisely that – a damper pedal, sustaining notes until you release the pedal. The **Assignable** pedal (or footswitch) may change depending on how it is programmed in the **Settings > Menu > Controllers > Foot** page.

Using the control sliders and buttons

Depending on the selected mode, the **CONTROL** sliders and buttons can control different things, like volume levels of the different sounds, the organ drawbars or some assignable functions. How they work is shown by the strip display under the sliders.

Using the assignable switches

Depending on the chosen Keyboard Set and the assigned functions, these controllers can do different things. With the DNC Sounds, the switches can either 'book' a function, that will be triggered while playing, or enable (or disable) it by pressing the button to 'toggle' it. In other cases, these switches can 'toggle' or 'trigger' the assigned function.

Indicator status	Meaning
Off	No DNC function assigned.
Purple steady	Booking DNC function available.
Purple blinking	Booking DNC function waiting to be executed. Then, it will return steady.
Light green steady	Toggle DNC function available.
Light green blinking	Toggle activated. Press it again to disable it.

Using the Matrix

The **Matrix** of programmable buttons can do several different things (triggering Pads, Chords Sequences, Track Play/Mute, etc.). Press one of the four **preset** buttons under the Matrix to choose a set of functions. Touch one or more of the **Matrix buttons** to select the corresponding function. If they are on/off switches, touch them again to turn them off.

The color of the switches may change, depending on the assigned function and the selected Player. Switches with no function assigned are off.

Indicator status	Meaning
Off	No function assigned.
Orange/Blue steady	Function activated.
Orange/Blue blinking	On-shot function playing.

Using the joystick

Moving the joystick left of right usually changes the Sound's pitch. Moving it forward usually add modulation, but this depends on the selected sounds. With the electro-mechanical organs, pushing the joystick forward changes the rotary speaker's speed. What it does when pulled back depends on the selected Sounds. Just experiment!

Using the ribbon controller

Sweeping left of right on the ribbon controller usually changes the brilliance of the sounds and/or the pitch, but how it works depends on the selected sounds.

Customizing the Keyboard Sets

Playing different Sounds with the left and right hand

Splitting the keyboard

- Split the keyboard into a Lower (left hand) and Upper (right hand) part
- > Press the **SPLIT** button on the control panel to light up its indicator. The keyboard will be divided into a Lower (left hand) and Upper (right hand) part.

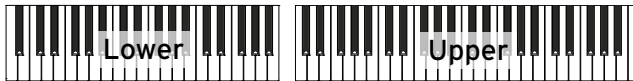

The **split status icon** is shown in the **Main** page, next to the name of the Keyboard Set. Which of the Upper and Lower Sound is playing is also shown (green parts are playing, dimmed ones are muted).

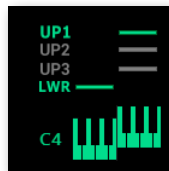

You can see the Sounds assigned to each part in the **Home > Keys** page.

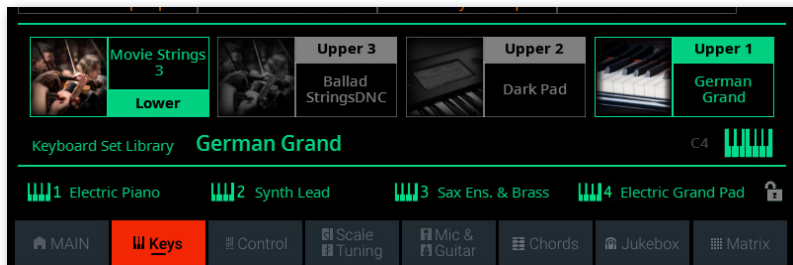

■ Remove the split and play the Upper Sounds over the full keyboard range

> Press the **SPLIT** button again to turn its indicator off. The Upper Sounds will play on the full keyboard range, as in an acoustic piano.



The **full keyboard status icon** is shown, next to the name of the Keyboard Set. Which of the Upper and Lower Sound is playing is also shown.

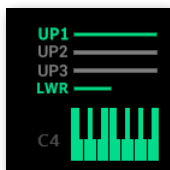

Split, Keyboard modes, Sounds

When changing the **SPLIT** status, the number of Sounds you hear may change.

SPLIT indicator	Keyboard mode	Left hand (Lower) Sounds	Right hand (Upper) Sounds
Off	Full	No Lower Sound	Up to three Upper Sounds assigned to the full extension of the keyboard
On	Split	A single Lower Sound assigned to the left hand	Up to three Upper Sounds assigned to the right side of the keyboard.

Changing the local split point

You can choose a different point where the keyboard divides into an Upper and a Lower part. This is called the **split point**.

■ Change the local split point from the control panel

1 While in the **Home > Main** or **Keys** page, touch the **Split** icon to open the **Split** dialog.

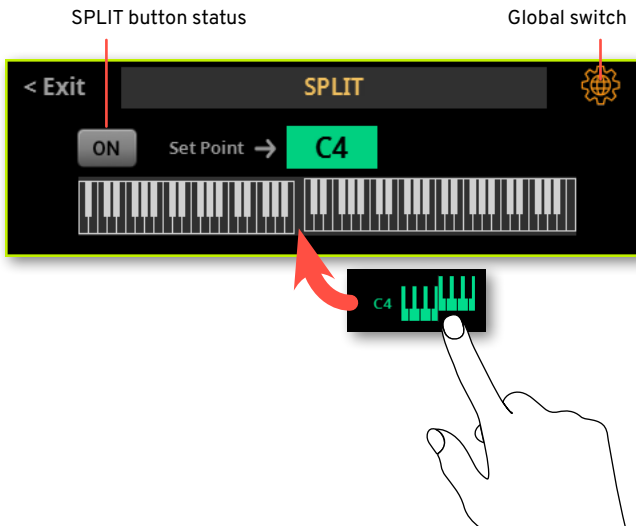

2 Touch the **keyboard diagram** in the display. When the **Press a key** message appears, play the lowest note of the Upper (right) part on the keyboard.

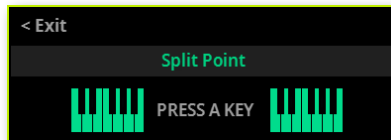

As an alternative, touch the **Set Point** parameter to select it, and use the **DIAL** or **UP/DOWN** controls to select the new split point.

When you change the split point, the **Global** switch is automatically deselected. The split point is now local (see 'Global' and 'local' split point on page 91).

■ Memorize the local split point

The local split point can be memorized into a Keyboard Set. Each Keyboard Set associated to a Style or SongBook Entry can have a different split point.

- Save the changes to a User Keyboard Set.

Changing the global split point

The global split point is both the general setting you use when there is no local split point, and a ‘template’ from which to start setting the various local split points saved into the Keyboard Sets. You can edit it and use it as the main split point of the instrument. Some Keyboard Sets might override the global split point with their own local split point.

■ Change the global split point

- 1 Go to the **Settings > Menu > Preferences > Style** page.

As an alternative, keep the **SHIFT** button pressed and press one of the **PLAYER > STYLE** buttons to open the **Style** page.

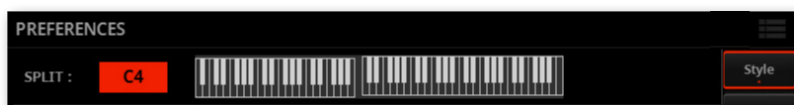

- 2 Touch the **keyboard diagram** in the display. When the **Press a key** message appears, play the lowest note of the Upper (right) part on the keyboard.

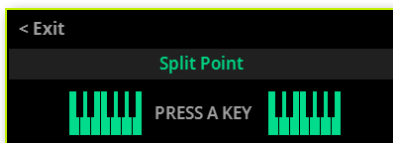

As an alternative, touch the **Split** parameter to select it, and use the **DIAL** or **UP/DOWN** controls to select the new split point.

- 3 Press the **EXIT** button to return to the previous page.

'Global' and 'local' split point

You can choose a 'global' split point that is not changed when choosing a different Keyboard Set. Or you can choose a 'local' split point that is better suited to the individual Keyboard Set, and can change when selecting it. The current 'local' split point can be saved into a User Keyboard Set.

To change the type of split point, select or deselect the **Global** switch in the **Split** dialog.



Global Split	Split type	Meaning
On (Selected)	Global	Leave this box checked to use the global split point. This is the general setting from which you can start programming the local settings.
Off (Deselected)	Local	This box is automatically deselected when you start programming a local split point in the Split dialog. The local split point can be saved into a User Keyboard Set. Use it when you need a particular split point for a particular Keyboard Set.

Playing two or three Sounds at the same time

You can play up to three layered Sounds on the keyboard. This is useful to add, for example, a layer of strings or synth pads to a grand piano sound. The Sounds will be assigned to the Upper part of the keyboard. When the **SPLIT** button indicator is turned off (**Full Keyboard** mode), the Upper parts will play on the full range of the keyboard, as it happens on an acoustic piano. Otherwise (**Split Keyboard** mode), you will play the Upper Sounds with the right hand.

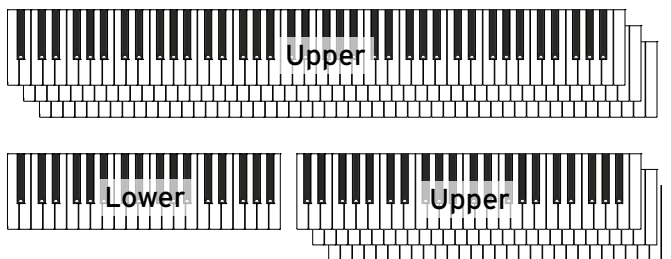

■ Turn a Sound on or off from the control panel

> Use the **LOWER**, **UPPER3**, **UPPER 2** and **UPPER1** buttons in the **KEYBOARD** section to turn the corresponding Sounds on or off.



■ Turn the selected Sound on or off from the display

1 Go to the **Home > Keys** page. Sounds with icons in solid colors are in play, while dimmed ones are in mute.

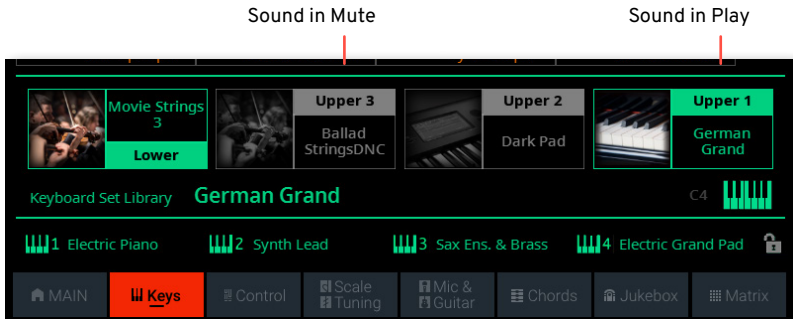

2 If the Sound you want to mute is in play, touch the **icon of the Sound category** to set it to mute.

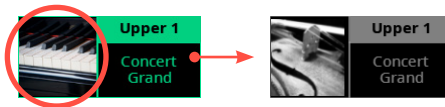

3 If the Sound you want to hear is in mute, touch the **icon of the Sound category** to set it to play.

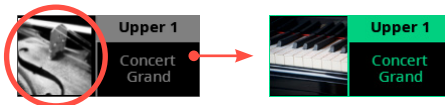

■ Memorize the Sound status

> Save the changes to a User Keyboard Set.

Choosing different Sounds

You can assign different Sounds to the keyboard. The new combination of Sounds can then be saved into a User Keyboard Set.

You can follow the same procedure when choosing Sounds for the other combinations of Sounds (Style and MIDI Song tracks, that can be saved into the current User Style or a MIDI Song).

■ Open the Select window from the control panel

- 1 Press the **KBD/PAD** mode button in the **CONTROL** section.



- 2 If you want, press the **VIEW** button to turn its lower indicator on, and see the functions assigned to the **CONTROL** buttons. As you see, the buttons are programmed as **Sound Select** buttons for the corresponding parts.

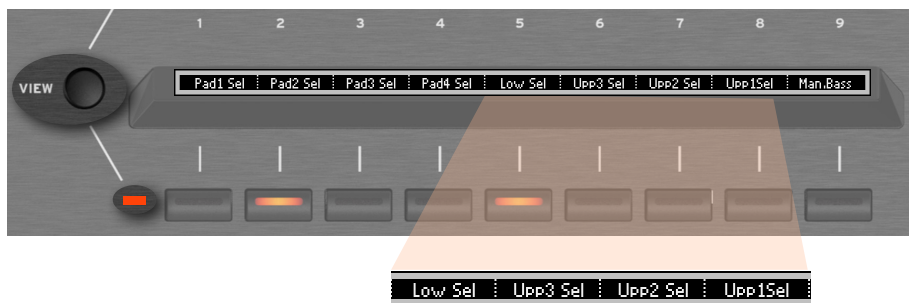

- 3 Press the **CONTROL** button corresponding to the Sound you want to change.

■ Open the Select window from the display

- > While in the **Home > Keys** page, touch the **name of the Sound** you want to change.

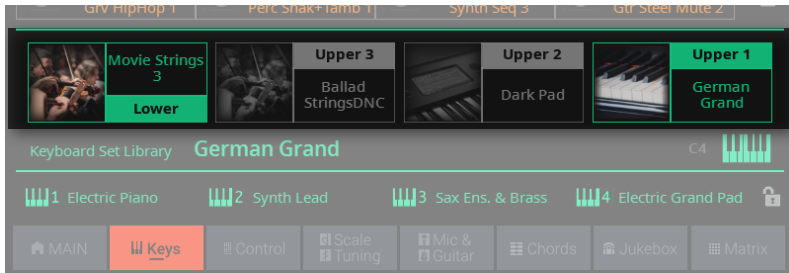

- > While in the **Home > Control** page, touch the **Select** button corresponding to the Sound you want to change.



■ Choose a Sound

- 1 Browse through the Sounds in the **Sound Select** window.

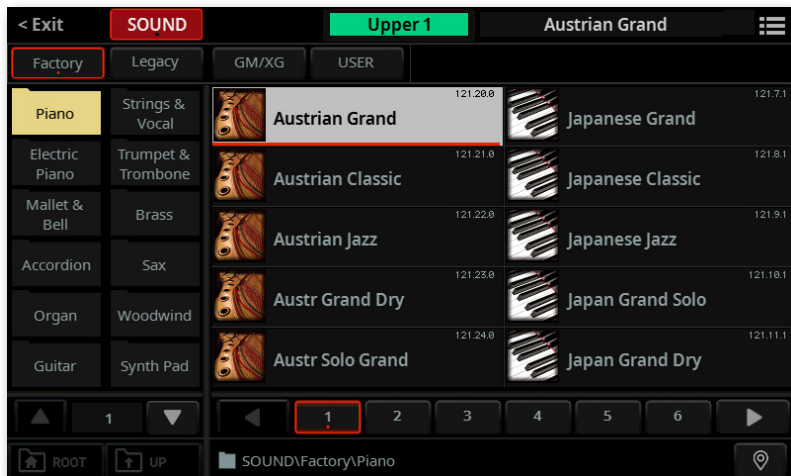

2 To choose one of the available **types of Sound**, touch the **buttons** at the top of the window.



Type of Sound	Meaning
Factory	Standard Pa5X Sounds, that can't be modified or overwritten. These are the richest, most modern Sounds of the whole collection.
Legacy	Legacy Sounds, allowing for greater compatibility with older Pa-Series instruments.
GM/XG	Sounds allowing for full compatibility with MIDI Songs based on General MIDI and XG Sounds and Drum Kits.
User	Internal memory area where you can load new Sounds and Drum Kits from an external device, or save new or edited Sounds and Drum Kits.

3 In case you want to choose a different category, touch one of the category folders in the left side of the **Sound Select** window.

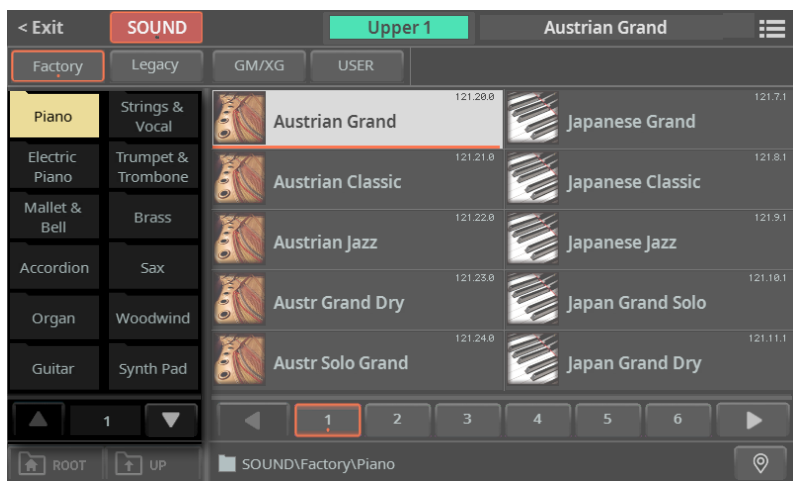

- 4 The Sounds contained in the selected folder appear in the right side of the window.

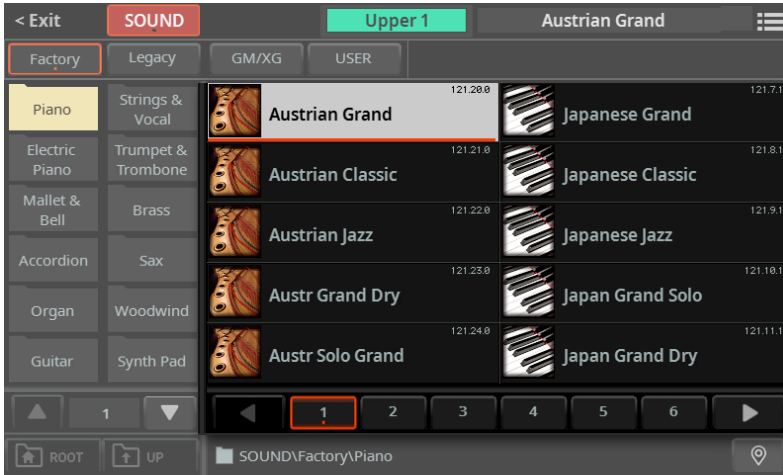

- 5 If you are lost while browsing through the data, you can return to the folder containing the selected element by touching the **Locate** (📍) button.
- 6 Touch the **name of the Sound** you want to choose.
- 7 If you want to close the **Select** window (and it does not close by itself), press the **EXIT** button.

HINT: When a window does not close by itself, it means the **Display Hold** option is turned on. See **Display Hold** on page 67.

In the end, you will see the name of the selected Sound in the dedicated area of the **Keys** page.

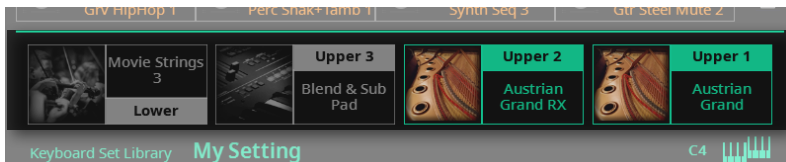

- **Memorize the assigned Sounds**
- Save the changes to a User Keyboard Set.

Transposing the Upper Sounds to a different octave

All Upper Sounds can be transposed to an upper or lower octave using the **UPPER OCTAVE -** and **+** buttons. The current octave transposition is shown in the status bar.



-
- **Transpose the Upper Sounds one octave up**
 - > Press the **UPPER OCTAVE +** button on the control panel.

 - **Transpose the Upper Sounds one octave down**
 - > Press the **UPPER OCTAVE -** button on the control panel.

 - **Reset the octave transposition**
 - > Press both **UPPER OCTAVE** buttons together.

 - **Memorize the Sound transposition**
 - > Save the changes to a User Keyboard Set.

Using the Ensemble to add harmony

There are several types of Ensemble, but with most of them what you play with your right hand will be harmonized with the chords you play with your left hand.

Turning the Ensemble on or off

■ Turn the Ensemble function on

- 1 Be sure the **SPLIT** indicator is turned on.
- 2 Press the **ENSEMBLE** button to light up its indicator.

Play chords with your left hand, and a melody with your right hand. You will hear the chord notes added to the melody.

■ Turn the Ensemble function off

- > Press the **ENSEMBLE** button again to turn its indicator off.

Choosing an Ensemble type

■ Select a different harmonization style

1 Go to the **Home > Menu > Keyboard/Ensemble > Ensemble** page.

As an alternative, keep the **SHIFT** button pressed, and press the **ENSEMBLE** button to open the **Ensemble** page.

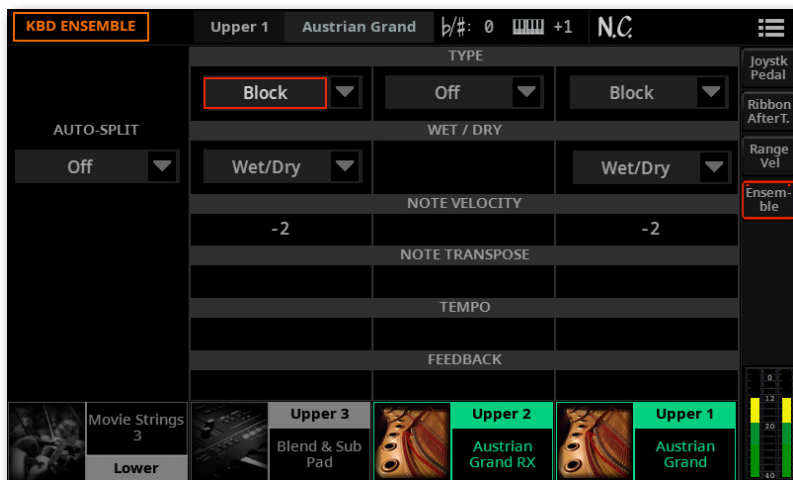

2 Use the **Type** parameter to choose an **Ensemble type** for each of the Upper Sounds.

Ensemble type	Meaning
Duet	Adds a single note to the melody.
Close	Adds a closed-position chord to the melody.
Open 1	Adds an open-position chord to the melody.
Open 2	As the above, but with a different chord shape.
Block	Block harmonization – very typical of jazz music.
Power Ensemble	Adds a fifth and an octave to the melody, as heard in hard rock.
Third UP	This option adds a third over the melody note (depending on the recognized chord).
Fourths LO	Typical of jazz, this option adds two perfect fourths under the melody.
Fourths UP	As the above, but with notes added over the melody.
Fifths	This adds two fifths below the original note.
Octave	Adds an octave to the melody.
Dual	This option adds to the melody line a second note, at a fixed interval set with the “Note” parameter. When selecting this option, a transposition value appears (-24...+24 semitones to the original note).
Brass	Typical Brass section harmonization.
Reed	Typical Reed section harmonization.
Trill	When two notes are played on the keyboard, this option trills them. If three or more notes are played, only the last two are trilled. You can set the trill speed by using the Tempo parameter (see below).
Repeat	The played note is repeated in sync with the Tempo parameter (see below). When playing a chord, only the last note is repeated.
Echo	As the Repeat option, but with the repeated notes fading away after the time set with the Feedback parameter (see below).

3 Use the **Wet/Dry** parameter to enable/disable the original note.

Wet/Dy	Meaning
Wet/Dry	Both the original note and the harmonization notes will play.
Wet Only	Only the harmonization notes will play.

4 Use the **Auto Split** parameter to assign a different musical role to each of the Upper Sounds.

Auto Split	How it works
Top Note	If more than a single Upper Sound is in play, the last uppermost note is assigned to Upper 1, while the other Upper Sounds, if available, play the other chord notes.
Top Retrigger	If the uppermost note is released, while other notes are still playing, the uppermost note is retriggered and assigned to Upper 1.
Top & Bottom Note	If all the Upper Sounds are in play, the last uppermost note is assigned to Upper 1, the last lowermost note is assigned to Upper 3, while Upper 2 plays the other chord notes.
Top & Bottom Retrigger	If the uppermost note is released, while other notes are still playing, the uppermost note is retriggered and assigned to Upper 1. When the lowermost note is released, while other notes are still playing, the lowermost note is retriggered and assigned to Upper 3.

5 When they appear, adjust the **additional parameters**.

Additional parameters	How it works	Value
Note Velocity	Velocity (dynamics) difference between the melody played with your right-hand and the added harmonization notes.	-10...0
Note Transpose	Transposition of the harmonization notes. ± 12 semitones = ± 1 octave.	-24...0...+24
Tempo	Note duration for the Trill, Repeat or Echo Ensemble options. This is in sync with the Tempo value.	1/23...4/4
Feedback	Repetitions of the original note/chord when the Echo option is selected.	1...8

■ Exit the Ensemble settings page

- > Press the **EXIT** button to return to the previous page.

■ Memorize the Ensemble settings

- > Save the changes to a User Keyboard Set.

The Favorite Keyboard Sets

Choosing a Favorite Keyboard Set

Favorite Keyboard Sets are a selection of your preferred Keyboard Sets, that can be accessed by pressing a single button in the **KEYBOARD SET LIBRARY** section.

1 To select the Favorite Keyboard Sets, first light up the **FAVORITE** indicator by pressing the **CATEGORY/FAVORITE** button. The corresponding row of buttons will become available.



2 Press one of the **KEYBOARD SET LIBRARY** buttons (lower row, buttons 1-11) to select the corresponding Favorite Keyboard Set.

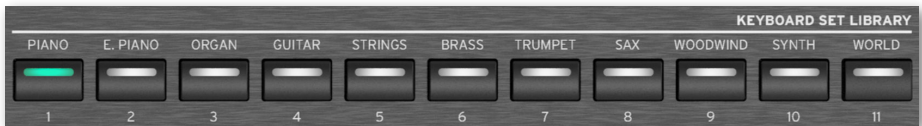

3 Press the **CATEGORY/FAVORITE** button again to return to the regular Keyboard Sets (upper row, buttons **PIANO ... WORLD**).

Creating a list of Favorite Keyboard Sets

You can create your own list of Favorite Keyboard Sets.

- 1 Go to the **Settings > Menu > Controllers > Keyboard Set Favorites** page.

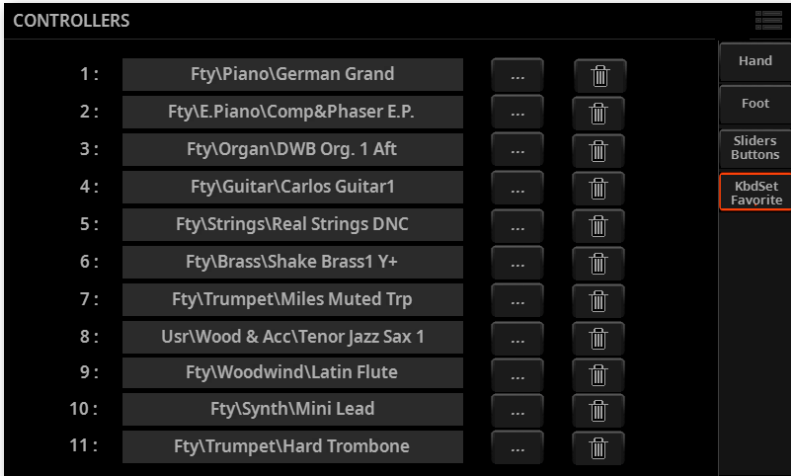

Each of the items in this page corresponds to one of the **FAVORITE** buttons in the **KEYBOARD SET LIBRARY** section on the control panel.

- 2 Touch the ... button next to the Favorite you want to replace. The **Keyboard Set Select** window will appear.

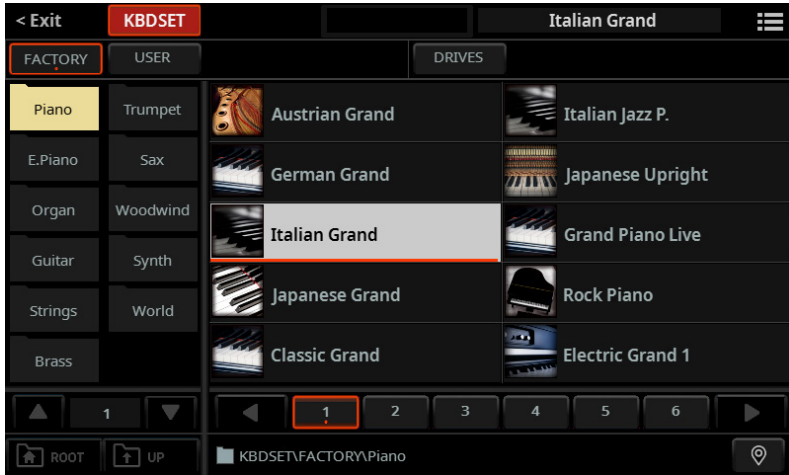

- 3 Browse through the drives and folders, and choose the desired Keyboard Set.

04

Volume and Control

Adjusting the volume

The Master Volume

The general volume control, adjusting the output volume for the headphones, the main outputs and the integrated speakers (if installed) is the **MASTER VOLUME** slider.

CAUTION: Set the volume to a comfortable level. A level too high can damage your hearing!

- > Move the slider up to increase the output level.
- > Move the slider down to decrease the output level.

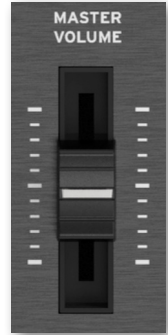

The X-Fader

The **X-FADER** (short for ‘crossfader’) allows for mixing the two Players.

■ Assign a Style or Song to each of the Players

➤ Either use the **STYLE** or **SONG** button in the **PLAYER 1** or **PLAYER 2** sections, or touch the **name of the Style or Song** in the display.

For more details, please see the relevant chapters in the manual.

■ Start both Players at the same time

➤ If you want to synchronize both Player’s Tempo to the Tempo of the current Player, turn the **TEMPO > LOCK** on.

➤ Keep the **SHIFT** button pressed, and press any of the two **PLAY/STOP** (▶◻) buttons to start both Players at the same time.

■ Mix the two Players

➤ During playback, move the **X-FADER** slider to mix the two Players.

➤ Move the **X-FADER** slider fully to the left to only listen to Player 1, fully to the right to only listen to Player 2. Move it to the center to balance the two Players.

The indicator over the corresponding Player section will turn on.



■ Separately control each Player

➤ During playback, control each Player by using the dedicated **PLAYER** controls on the control panel.

■ Stop the Players

- > Press the **PLAY/STOP** (▶◻) button to stop the corresponding Player. If you are playing a Song, it will pause at the current position.
- > Press the **STOP/GO TO START** (◀◻) button to stop the corresponding Player. If you are playing a Song, it will be rewound to the beginning.
- > Keep the **SHIFT** button pressed, and press any of the two **PLAY/STOP** (▶◻) buttons to stop both Players at the same time.

■ Fade between songs

Instead of starting both Players together, you can start them one after the other, and fade between them.

- 1 Assign a first Style or Song to Player 1, and a second Style or Song to Player 2.
- 2 Move the **X-FADER** slider fully to the left, to only listen to Player 1.
- 3 Start Player 1.
- 4 When the song is nearing the end, start Player 2.
- 5 Smoothly move the **X-FADER** slider toward the right, to fade out the first Player and fade in the second Player.
- 6 While Player 2 is playing, assign a third Style or Song to Player 1, and repeat the above procedure (by reversing the **X-FADER** direction) to fade out Player 2 and fade in Player 1.

The Control section

The individual volume levels and buttons

The sliders and the buttons in the **CONTROL** section are always accessible, whichever the page you are in.



The **mode buttons** on the right allow for choosing different sets of programming for the sliders and the buttons.

The **sliders** allow for adjusting the volume of the Keyboard Sounds, the Pads, the two Players (with their Style or Song), or the individual Sounds. They also allow for controlling the level of the Audio Inputs.

The **buttons** allow for switching functions on/off, or muting/setting back to play the individual Sounds. They also allow for turning the Audio Inputs on/off.

The Easy Edit, Drawbars and User modes also allow for controlling other parameters of the sound. The User mode also allows for mixing the sound parameters with any other type of controls.

Adjusting the levels from the control panel

The **CONTROL** section can work in one of five modes. Each mode controls a particular set of elements or groups of elements.

1 Press one of the **mode buttons** on the right of the **CONTROL** section to choose one of the modes. Its indicator will turn on.



2 With MIDI Songs, you can press the **SONG** mode button again to cycle between Tracks 1-8 and 9-16. When the button is pressed again, you can briefly see the sliders' MIDI value.

3 To see which function is assigned to each slider or button, check the **strip display** under the sliders.



4 You can alternate between the sliders and the buttons by pressing the **VIEW** button. An indicator will turn on next to the sliders or the buttons, to tell what is shown in the strip display.

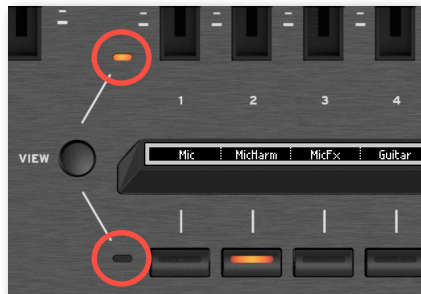

Adjusting the levels from the display

1 Go to the **Home > Control** page. This mirrors the **CONTROL** section on the control panel.

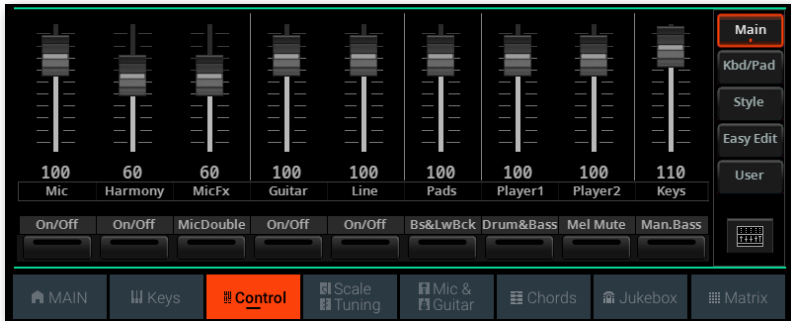

2 Choose the control mode with the **mode buttons** on the right side of the page.

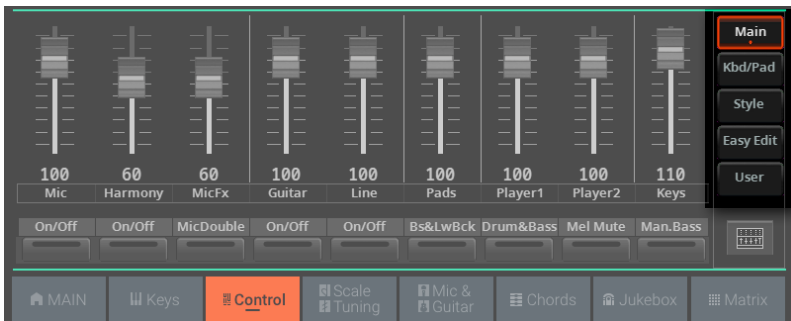

3 Check the functions assigned to the sliders and the buttons with the **labels** between them. The labels mimic the **strip display** on the control panel.

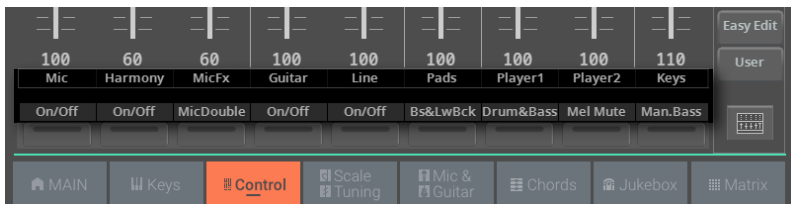

4 With MIDI Songs, you can touch the **Song** mode button again to cycle between Tracks 1-8 and 9-16.

5 Drag the virtual slider whose level you want to change.

As an alternative, use the **DIAL** or **UP/DOWN** controls to change the volume level of the selected channel.

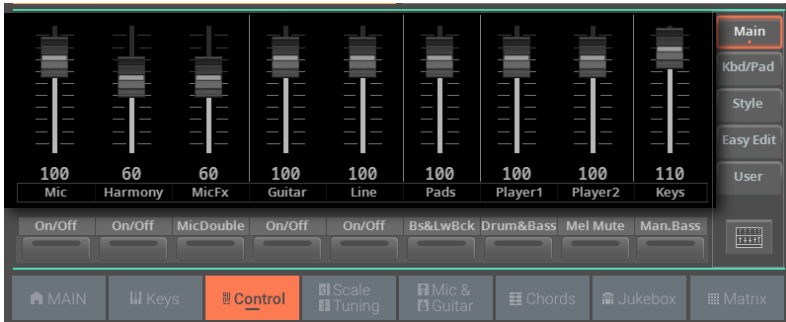

6 Touch the button whose function you want to turn on/off.



Switching to the Mixer page

While in the **Home > Control** page, you can quickly switch to the **Mixer**, and adjust the individual levels of the Sounds.

- 1 Touch the **Mixer** button to switch to the **Home > Menu > Mixer > Main** page.

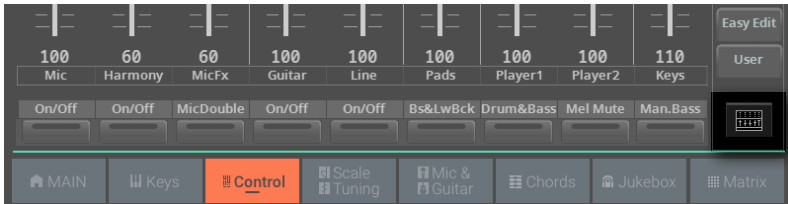

- 2 While in the **Mixer**, adjust the level and other parameters of the individual Sounds.



- 3 Press the **EXIT** button if you want to return to the **Home > Control** page.

The Control modes in detail

Each control mode gives access to a particular set of elements or groups of elements.

The Main control mode

The **Main** mode controls groups of sounds, like the Keyboard, the Players, and the audio inputs. It also includes switches for the Drum&Bass and the Manual Bass functions (that can be used with the Styles).

Access this mode by pressing the **MAIN** mode button in the **CONTROL** section.

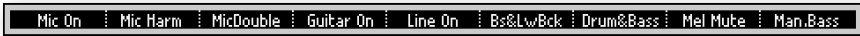
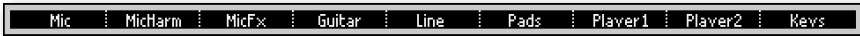

#	Slider	controls the level of...	Button	turns on/off...
1	Mic	Microphone input	On/Off	Microphone input
2	Harmony	Harmony voices	On/Off	Harmony voices
3	MicFx	Delay and Reverb effects on the Mic input.	MicDouble	Doubling voice
4	Guitar	Guitar input	On/Off	Guitar input
5	Line	Audio from the Line input	On/Off	Audio from the Line input
6	Pads	The Pads (proportionally)	Bs&LwBck	Bass&Lower Backing
7	Player 1	Style or Song from Player 1	Drum&Bass	Drum&Bass
8	Player 2	Style or Song from Player 2	Mel.Mute	Mutes the melody track or a MIDI Song Melody and the solo voice of a MP3 Song
9	Keys	The Keyboard Sounds as a whole	Man.Bass	Manual Bass

The Keyboard/Pad control mode

The **Keyboard/Pad** mode controls the volume of the individual Pads and Keyboard Sounds. It also controls the Keyboard Sounds as a whole. A set of switches lets you open the **Select** window to choose the Pads and the Keyboard Sounds. It also includes a switch for the Manual Bass function.

Access this mode by pressing the **KBD/PAD** mode button in the **CONTROL** section.

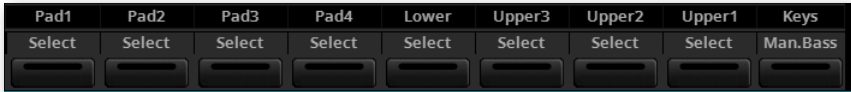

#	Slider	controls the level of...	Button	selects...
1	Pad1	Pad 1	Select	Pad 1
2	Pad2	Pad 2	Select	Pad 2
3	Pad3	Pad 3	Select	Pad 3
4	Pad4	Pad 4	Select	Pad 4
5	Lower	Lower Sound	Select	Lower Sound
6	Upper3	Upper 1 Sound	Select	Upper 3 Sound
7	Upper2	Upper 2 Sound	Select	Upper 2 Sound
8	Upper1	Upper 3 Sound	Select	Upper 1 Sound
9	Keys	All the Keyboard Sounds	Man.Bass	Turns Manual Bass on/off

The Style control mode

The **Style** mode controls the volume of the individual Style Sounds, when a Style is playing or selected to play. It also controls the Keyboard Sounds as a whole. You can mute each of the Style Sounds. You can turn the Metronome on/off.

Access this mode by pressing the **STYLE/SONG** mode button in the **CONTROL** section when a Style is assigned to the current Player.

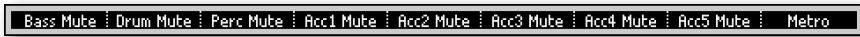
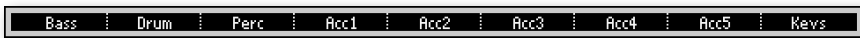
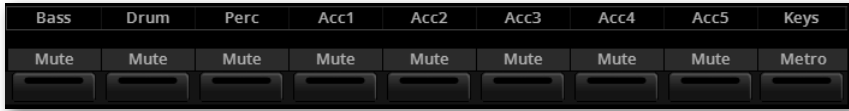

#	Slider	controls the level of...	Button	mutes...
1	Bass	Bass Style Track	Mute	Bass Style Track
2	Drum	Drum Style Track	Mute	Drum Style Track
3	Perc	Percussion Style Track	Mute	Percussion Style Track
4	Acc1	Acc1 Style Track	Mute	Acc1 Style Track
5	Acc2	Acc2 Style Track	Mute	Acc2 Style Track
6	Acc3	Acc3 Style Track	Mute	Acc3 Style Track
7	Acc4	Acc4 Style Track	Mute	Acc4 Style Track
8	Acc5	Acc5 Style Track	Mute	Acc5 Style Track
9	Keys	All the Keyboard Sounds	Metro	Turns Metronome on/off

The Song control mode

The **Song** mode controls the volume of the individual MIDI Song Sounds, when a MIDI Song is playing or selected to play. It also controls the Keyboard Sounds as a whole. You can mute each of the Song Sounds. You can turn the Metronome on/off.

Access this mode by pressing the **STYLE/SONG** mode button in the **CONTROL** section when a MIDI Song is assigned to the current Player.

MIDI Songs have sixteen tracks, each one with a Sound assigned. To cycle between Tracks 01-08 and Tracks 09-16, press the **STYLE/SONG** button again in the **CONTROL** section, or touch the **Song** button again in the **Home > Control** page.

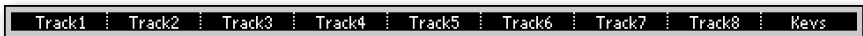
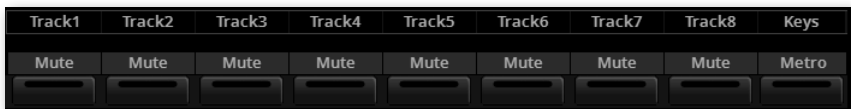

#	Slider	controls the level of...	Button	mutes...
Tracks 01-08				
1	Track1	MIDI Song Track 01	Mute	MIDI Song Track 01
2	Track2	MIDI Song Track 02	Mute	MIDI Song Track 02
3	Track3	MIDI Song Track 03	Mute	MIDI Song Track 03
4	Track4	MIDI Song Track 04	Mute	MIDI Song Track 04
5	Track5	MIDI Song Track 05	Mute	MIDI Song Track 05
6	Track6	MIDI Song Track 06	Mute	MIDI Song Track 06
7	Track7	MIDI Song Track 07	Mute	MIDI Song Track 07
8	Track8	MIDI Song Track 08	Mute	MIDI Song Track 08
Tracks 09-16				
1	Track9	MIDI Song Track 09	Mute	MIDI Song Track 09
2	Track10	MIDI Song Track 10	Mute	MIDI Song Track 10
3	Track11	MIDI Song Track 11	Mute	MIDI Song Track 11
4	Track12	MIDI Song Track 12	Mute	MIDI Song Track 12
5	Track13	MIDI Song Track 13	Mute	MIDI Song Track 13
6	Track14	MIDI Song Track 14	Mute	MIDI Song Track 14
7	Track15	MIDI Song Track 15	Mute	MIDI Song Track 15
8	Track16	MIDI Song Track 16	Mute	MIDI Song Track 16
Keyboard				
9	Keys	The Keyboard Sounds as a whole	Metro	Turns the Metronome on/off

Since MIDI Songs are already dynamically mixed by the original creators, their volume may automatically change during playback.

The volume of the MIDI Song tracks may change when choosing a different Song.

You can mute/unmute the Song track that you will want to play or sing live. The Melody track in a MIDI Song is usually #04.

The Easy Edit control mode

The **Easy Edit** mode controls the level of the most important parameters of the Upper Sounds. The changes are an offset relative to the saved values.

If you want to quick edit the individual Sounds, you can go to the **Home > Menu > Track Controls > Sound Edit** page.

The changes made here can be saved to a Keyboard Set.

Access this mode by pressing the **EASY EDIT/DWB** mode button in the **CONTROL** section when an ordinary Sound is selected.

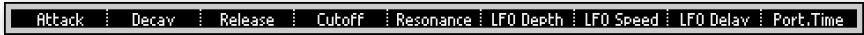

#	Slider	controls the value of...	Button	resets the value of...
1	Attack	Attack Time	Reset	Attack Time
2	Decay	Decay Time	Reset	Decay Time
3	Release	Release Time	Reset	Release Time
4	Cutoff	Filter Cutoff Frequency	Reset	Filter Cutoff Frequency
5	Resonance	Filter Resonance	Reset	Filter Resonance
6	LFO Depth	LFO Depth	Reset	LFO Depth
7	LFO Speed	LFO Speed	Reset	LFO Speed
8	LFO Delay	LFO Delay	Reset	LFO Delay
9	Port.Time	Portamento Time	Port.On	Turns Portamento on/off

The Drawbars control mode

When a Drawbar Sound is assigned to the keyboard, you can control the drawbars with the sliders in the **Drawbars** mode.

Access this mode by pressing the **EASY EDIT/DWB** mode button in the **CONTROL** section when a Digital Drawbars Sound is selected.

If you press the **EASY EDIT/DWB** button a second time, you get access to the **Digital Drawbars Edit** page (see [Editing the Digital Drawbars](#) on page 414).



#	Slider	controls the level of...	Button	turns on/off...
1	16'	Corresponding tonewheel	Dwb Perc	Drawbars percussion
2	5 1/3'		Dwb Harm	Percussion harmonic
3	8'		Dwb Leak	Drawbar Leak
4	4'		DwbKeyOn	Key On sound
5	2 2/3'		DwbKeyOff	Key Off sound
6	2'		Dwb Vibr	Vibrato*
7	13/5'		DwbOvdrw	Overdrive*
8	11/3'		DwbBrake	Rotary Speaker Brake*
9	1'		RotaryF/S	Switches between the Fast and Slow speed of the Rotary Speaker*

*) These controls are only available if the Organ Vibrato/Chorus, CX-3 Amp and one of the Rotary Speakers effects are assigned to the Internal FXs.

The User control mode

The **User** mode controls the parameters you assign to the sliders and buttons. This programming is unique and automatically saved in the Settings.

Access this mode by pressing the **USER** mode button in the **CONTROL** section.

To program the set of controls, go to the **Settings > Menu > Controllers > Sliders/Buttons** page.

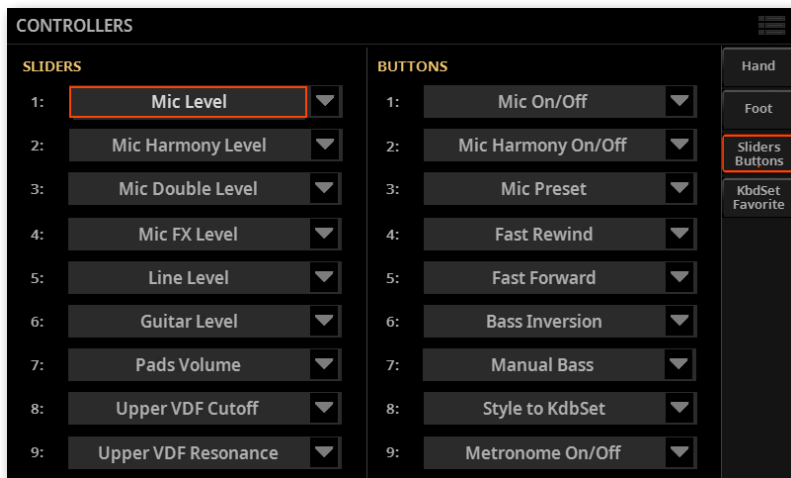

05

Tempo and Metronome

Tempo

Setting the Tempo value

While an optimal Tempo value is saved with each Style or Song, you can freely adjust it at your will. This will also set the Tempo for the Metronome.

Adjusting the Tempo value from the control panel

> Use the **TEMPO** controls to adjust the Tempo value (or the speed of the MP3 Song).

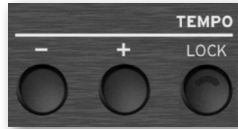

> As an alternative, for bigger Tempo changes, keep the **SHIFT** button pressed and use the **DIAL** or **UP/DOWN** controls.

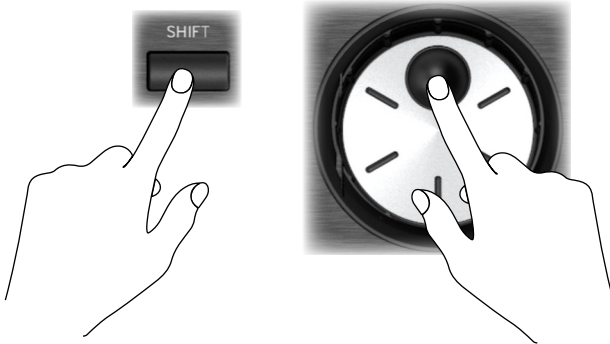

Adjusting the Tempo value from the display

- 1 If it is not highlighted, touch the **Tempo** value in the display.

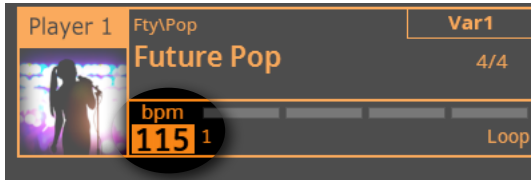

- 2 Use the **DIAL** or **UP/DOWN** controls to adjust the Tempo value.

As an alternative, touch the **Tempo** field again to open the **numeric keypad**, and enter the Tempo value as a number.

Resetting the Tempo value

- > Press both **TEMPO** buttons (+ and -) at the same time.

The Tempo value memorized in the Style or the MIDI Song will be recalled. With MP3 Songs, the original speed of the Song will be restored.



Other Tempo operations

'Tapping' the Tempo value

You can 'tap' (beat) the Tempo value of a Style or MIDI Song.

- > While no Style or MIDI Song is playing, beat the Tempo on the **RESET/TAP** button. Beat as many times as indicated by the **Meter** numerator (for example, three times in 3/4).



At the end, the Style or MIDI Song will start playing with the 'tapped' Tempo.

Resetting the Style or Song position to the beginning

While a Style or MIDI Song is playing, you can make it go back to the beginning.

- > While a Style or MIDI Song is playing, press this button to make it restart from the beginning.



Locking the Tempo value

You can prevent the Tempo value from automatically changing when choosing a different Style or MIDI Song. MP3 Songs are not affected by this 'lock', and will always play at the recorded Tempo.

You are free to continue setting the Tempo manually, including beating the Tempo with the **Tap Tempo** function.

Locking the Tempo value is very important to make both Players play at the same Tempo. When the Tempo Lock is enabled, both the Players will play at the Tempo of the selected Player, and changing Tempo will affect both Players.

Please remember you can start (and stop) both Players at the same time by keeping the **SHIFT** button pressed and pressing one of the **PLAY/STOP** (▷◻) buttons.

■ Prevent the Tempo value from changing

> Press the **TEMPO > LOCK** button to light up its indicator. The Tempo value will not change when choosing a different Style or Song. You can still manually change the Tempo value (as seen above).

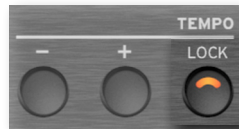

■ Let the Style or Song change the Tempo value

> Press the **TEMPO > LOCK** button again to turn its indicator off. When choosing a different Style or Song, the memorized Tempo value will be recalled.

Tempo Change events found in the Style pattern or the MIDI Song may still change the Tempo.

Metronome

Turning the metronome on and off

Turning the metronome on

1 Be sure the **CONTROL** mode is including the **METRO** command. The **Style/Song** mode includes it, as well as the default **User** programming.

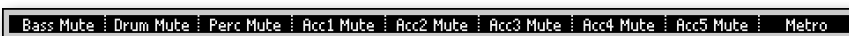
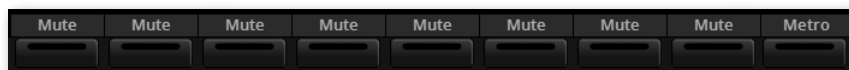

2 Press the **METRO** button to turn its indicator on. The **Metronome** window will open, and the metronome will start playing, beating the current Tempo.

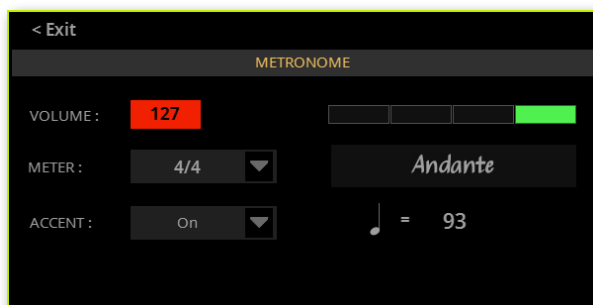

Turning the metronome off

> Press the **METRO** button to turn its indicator off. The metronome will stop.

Setting the meter, accent and volume

Setting the meter

You can mark the beginning of the measure, by setting the meter and accent.

- 1 Press the **METRO** button to open the **Metronome** window.

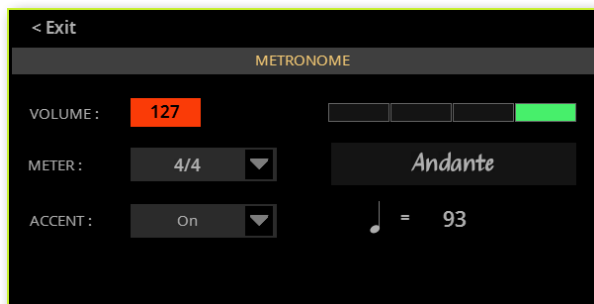

- 2 Use the **Meter** parameter to choose the meter (time signature).
- 3 Use the **Accent** parameter to choose the accent.

Accent	Meaning
Off	No accent.
On	The first beat of each measure is accented.
Bell	A bell sound is heard at the first beat of each measure.

Adjusting the metronome volume

- > While in the **Metronome** window, use the **Volume** parameter to adjust the metronome volume.

Closing the Metronome window

- > Press the **METRO** button to exit the window and stop the metronome.
- > Press the **EXIT** button to exit the window without stopping the metronome. Then, press the **METRO** button to stop the metronome.

Playing with the metronome

While the metronome is turned on, you can start a Player. The metronome will play at the same tempo of the Player. It will get the same tempo of the current Player.

When you stop the Player by pressing the **STOP/GO TO START (⏏)** button, the metronome will also stop. Its indicator will continue flashing at the current Tempo value.

06

Playing the Styles

The Styles

The Style and its Elements

Styles are collections of musical patterns in a particular music genre – or ‘musical style’ – offering an eight-parts automatic accompaniment, similar to an eight-member band playing with you. Chords you play on the keyboard will be recognized and will adapt the patterns to suit the music. Different sections can be selected to let you create a complete song in real time.

Accompaniment parts

Accompaniment parts are like the members of a band. With Pa5X you get five pitched instrument players (for example guitar, piano, strings, synthesizers), a bass player, a percussion player, and a drum player.

Chords and patterns

Accompaniment patterns are repeating musical patterns (like a bass groove, a guitar riff or a piano chord progression) that are dynamically adapted to match the recognized chords. They may vary depending on the type of chord (like C Major, C minor, or 7th).

Sections and Style Elements

Songs are made of different sections (Intro, Verse 1, Bridge, Chorus 1 and so on). There are different patterns for each song section, and they are collected under the Style Element buttons (INTRO, VARIATION, FILL, BREAK, ENDING). While the name of the Intro, Fill, Break and Ending are the same as the name of the corresponding song section, Variations can be used either for Verse, Bridge, Chorus or Special sections. The arrangement becomes denser the higher the element numbers go.



Auto Fill

Pa5X can automatically match each Variation with a Fill. When the **AUTO FILL** indicator is on, when going from a Variation to a different one a Fill is automatically selected, without having to press one of the **FILL** buttons.

Choosing the Styles

You can play a Style with either Player 1 or Player 2. If you want, you can assign a Style to each of the players, and have the other player be ready for the next musical selection. You can also mix Styles and Songs with the different Players.

HINT: You can let the Players automatically choose a Style at startup. To choose which one(s), go to the **Settings > Menu > General Controls > Startup** page (see [Assigning startup elements to the Players on page 431](#)).

You can choose a Style from the control panel or from the display.

We'll assign a Style to Player 1. Instructions for Player 2 would be identical, apart for the different player.

-
- **Open the Select window from the control panel**
 - > While in any page, press the **STYLE** button in the **PLAYER 1** section.
-

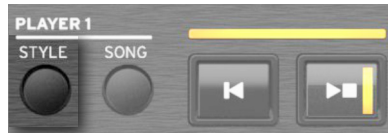

■ Open the Select window from the display

1 Go to the Home > Main page.

When turning the instrument on, you are already in the **Main** page. If you are not in the **Main** page, press the **EXIT** button in the control panel.

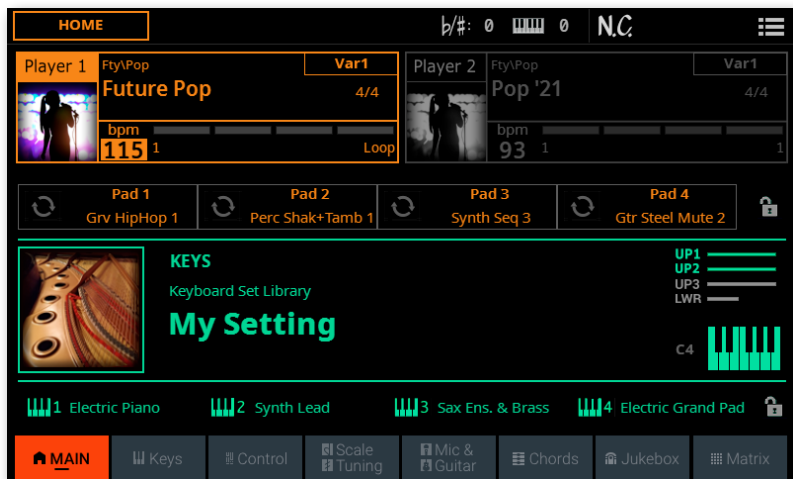

2 Touch the name of the Style (or Song) in the display.

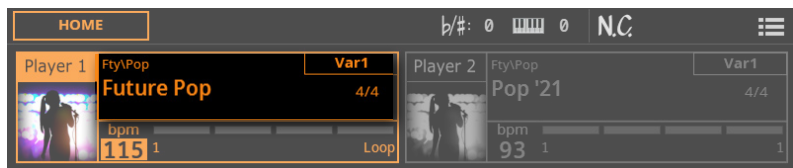

■ Choose a Style

- 1 Browse through the Styles in the **Style Select** window.

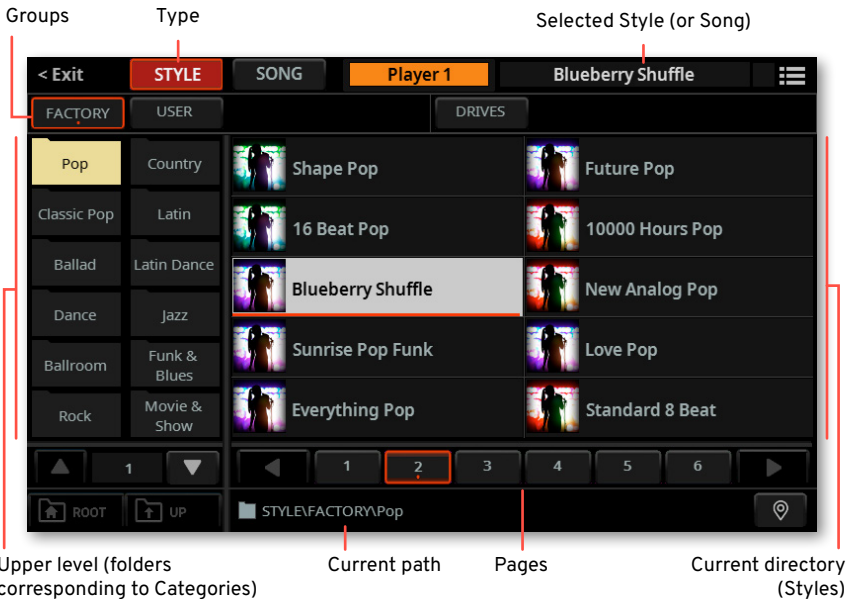

- 2 Be sure you are browsing the Styles, and not the Songs. If not, touch the **STYLE** button at the top of the window.

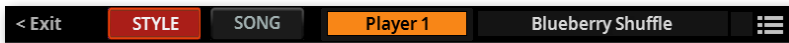

- 3 To choose one of the available **groups** from which to choose a Style, touch the **buttons** in the second line at the top of the window.



Group	Meaning
Factory	Styles included at the factory, that can't be modified or overwritten.
User	Internal memory area where you can save new or edited Styles, or where you can copy Styles from an external storage device.
Drives	Styles accessed from an external storage device. You can organize them freely, as if they were ordinary files.

4 If you are choosing from the **Drives**, choose one of the available **storage devices (drives)**, in the left side of the display, then browse through the folders inside the **selected drive**.

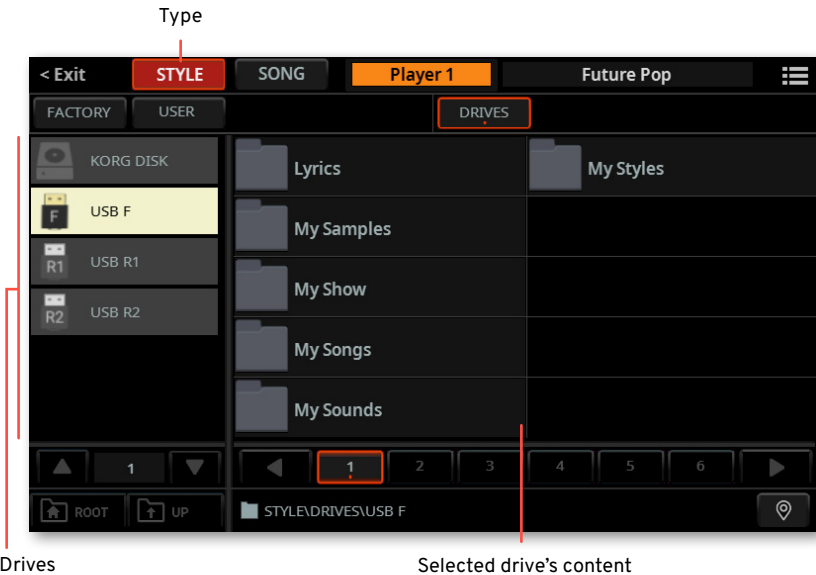

Drive	Meaning
KORG DISK	Storage space inside the internal drive (separate from the User area)
SD USER	Storage space inside the (optional) SD card
USB F	Storage device connected to the front USB HOST port
USB R1	Storage device connected to the rear USB HOST 1 port
USB R2	Storage device connected to the rear USB HOST 2 port

5 If you are choosing from the **Factory** or **User** banks, you will find the Styles organized in **categories** (shown as folders). If you want to choose a different category, touch one of the category folders in the left side of the **Style Select** window.

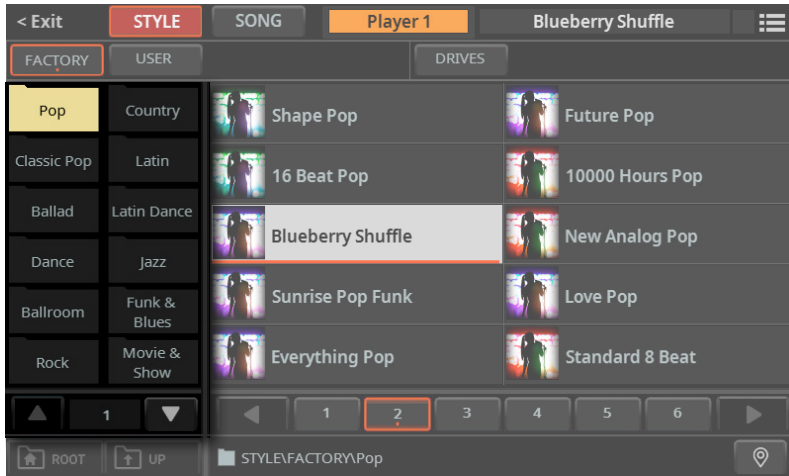

6 The Styles contained in the selected folder will appear in the right side of the window.

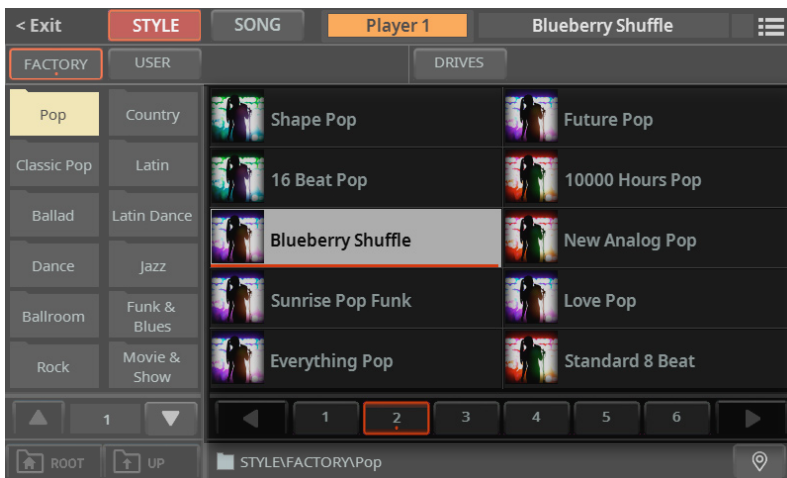

7 If you are lost while browsing through the data, you can return to the folder containing the selected element by touching the **Locate** (📍) button.

8 Touch the **name of the Style** you want to choose.

9 If you want to close the **Select** window (and it does not close by itself), press the **EXIT** button.

HINT: When a window does not close by itself, it means the **Display Hold** parameter is turned on. See **Display Hold** on page 67.

In the end, you will see the name of the selected Style in the dedicated area of the **Main** page.

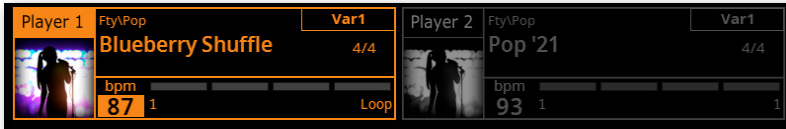

10 If you want, repeat the same procedure to assign another Style (or Song) to the other Player.

Selecting a Keyboard Set with the Style

The Style's Keyboard Sets

With each Style (and SongBook Entry) four Keyboard Sets are assigned to the **KEYBOARD SET** section under the **X-FADER**.



You can also choose them from the **Keyboard Set** area of the **Main page**.

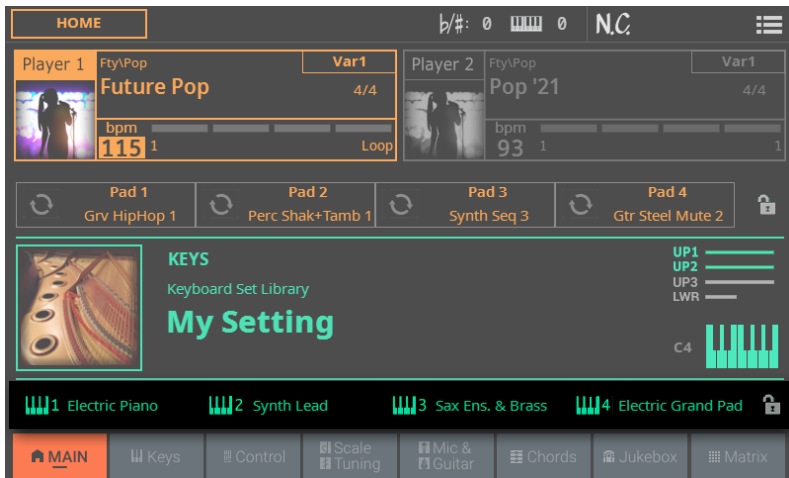

Turning the Style to Keyboard Set function on or off

Choosing a Style might also automatically select the first Keyboard Set in the **KEYBOARD SET** section under the **X-FADER**. This depends on the status of the **Style to Keyboard Set** function.

As per factory programming, this function is assigned to **CONTROL > BUTTON #8** when in **USER** mode.

■ Access the Style to Keyboard Set function from the control panel

1 Press the **USER** button in the **CONTROL** section.



2 Check in the **strip display** the functions assigned to the buttons. If they are not shown, press the **VIEW** button in the **CONTROL** section to see them.



■ Access the Style to Keyboard Set function from the display

> Go to the **Home > Control > User** pane.

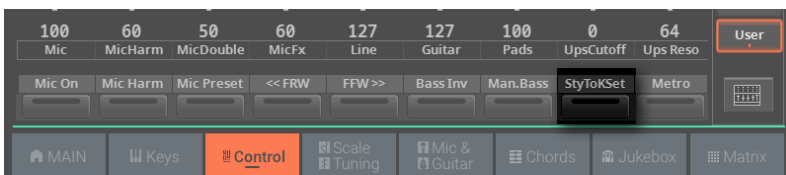

■ Turn the **Style to Keyboard Set** function on or off

- > Repeatedly press (or touch) the **Style to Keyboard Set** switch to set the function.

Style to Keyboard Set indicator	Meaning
Off	Styles don't select a Keyboard Set.
On	When choosing a Style, Keyboard Set #1 is automatically selected.
Blinking	Choosing a Variation automatically recalls the corresponding Keyboard Set (1 - 4) inside the Style. For example, choose Variation #2, and Keyboard Set #2 will be automatically recalled; choose Variation #3, and Keyboard Set #3 will be automatically recalled.

Programming the Style to Keyboard Set function

You can program how the **Style to Keyboard Set** button works.

1 Go to the **Settings > Menu > Preferences > Style** page.

As an alternative, keep the **SHIFT** button pressed and press the **PLAYER 1 > STYLE** button to open the **Style** page.

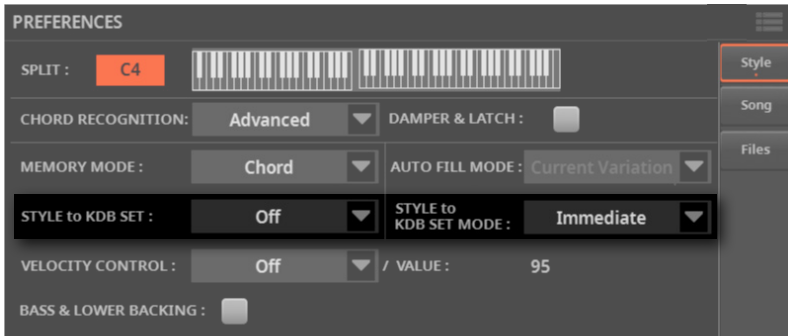

2 Use the **Style to Keyboard Set** menu to set the default status of the function.

Style to Keyboard Set indicator	Meaning
Off	Styles don't select a Keyboard Set.
On	When choosing a Style, Keyboard Set #1 is automatically selected.
Var to KbdSet	Choosing a Variation automatically recalls the corresponding Keyboard Set (1 – 4) inside the Style. For example, choose Variation #2, and Keyboard Set #2 will be automatically recalled; choose Variation #3, and Keyboard Set #3 will be automatically recalled. This is equivalent to the Style to Keyboard Set indicator blinking.

3 Use the **Style to Kbd Set Mode** menu to choose when the Keyboard Set should be selected.

Style to Kbd Set Mode	Meaning
Next Measure	When you choose a Style, the new Keyboard Set will not be automatically selected until the first beat of the next measure is reached.
Immediate	When you choose a Style, the new Keyboard Set will be immediately selected.

4 Press the **EXIT** button to return to the previous page.

Playing the Styles

Starting and stopping the Styles

You can manually start and stop the automatic accompaniment, by using the controls in the **PLAYER 1** or **PLAYER 2** section.



■ Set the right mix

> Move the **X-FADER** fully toward the Player you want to listen to. Move it fully to the left for Player 1, to the right for Player 2.

The indicator over the corresponding Player section will turn on.

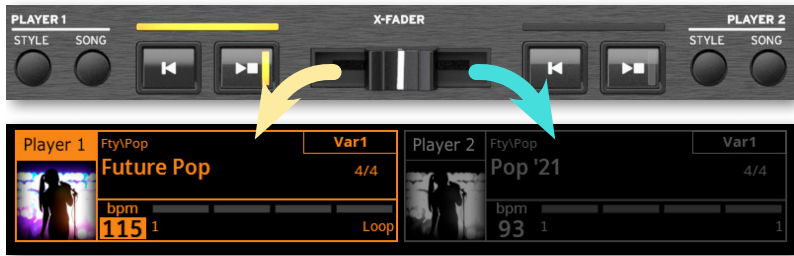

> Move it to an intermediate position to mix the two Players.

■ Start the accompaniment

- 1 Press the **PLAY/STOP** (▷□) button.
- 2 Play some chords with your left hand, while playing a melody with your right hand.

While the accompaniment is playing, please note the various indicators in the display.

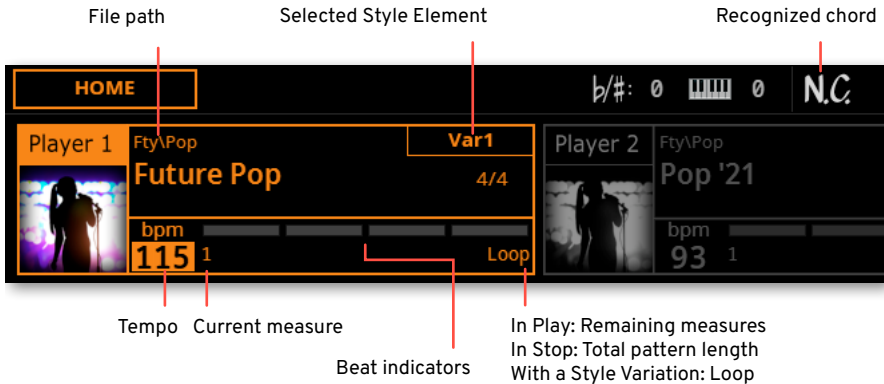

■ Stop the accompaniment

- > Press the **PLAY/STOP** (▷□) button again.
- > As an alternative, you can press the **STOP** (⏏) button.

■ Start and stop both Players at the same time

You can start both Players at the same time, to mix them with the **X-FADER** while playing.

- > Keep the **SHIFT** button pressed, and press any of the two **PLAY/STOP** (▷□) buttons to start both Players at the same time.
- > Keep the **SHIFT** button pressed, and press any of the two the **PLAY/STOP** (▷□) buttons to stop both Players at the same time.

Automatic start and stop

You can let the Players automatically start or stop by just playing the keyboard in the chord recognition area, without having to press the **PLAY/STOP** (▷◻) button. This leaves your hands free for playing.

This will work with either a Style or a Song assigned to the Player.

■ Make the Player start automatically (Synchro Start)

- 1 Press the **SYNCHRO > START** button to light up its indicator.



- 2 Play a chord, and see how the Player will start automatically.
- 3 Stop the Player by pressing the **PLAY/STOP** (▷◻) button.

■ Make the Player start and stop automatically (Synchro Start and Stop)

- 1 Be sure the **SYNCHRO > START** indicator is turned on.
- 2 Press the **SYNCHRO > STOP** button, to light up both the **START** and **STOP** indicators.



- 3 Play a chord to start the Player, and keep the keys pressed.
- 4 Lift your hands from the keyboard, and see how the Player will automatically stop.

■ Make the Player stop automatically (Synchro Stop)

1 Press the **SYNCHRO > START** button again to turn it off, and leave only the **SYNCHRO > STOP** indicator lit.



2 Press the **PLAY/STOP** ($\triangleright \square$) button to start the Player, then play a chord and keep the keys pressed.

3 Lift your hands from the keyboard, and see how the Player will automatically stop.

■ Deactivate the Synchro Start/Stop functions

> Press the **SYNCHRO > START** and/or **SYNCHRO > STOP** buttons to turn both indicators off.



Choosing the Style Elements from the control panel

You can use the **buttons** in the **STYLE ELEMENT / MARKER** section on the control panel to choose the Style Elements. With a Style assigned to the current Player, the **indicator** on the left of the buttons will show that the Style Elements can be selected.



Choosing an Intro

An Intro is the introduction of the song. To choose the right Intro for your song, please note that **Intro 1** plays a short pattern with a prerecorded chord sequence and melody, while **Intro 2** plays on the chord recognized on the keyboard. **Intro 3** is usually a one-bar Count In.

Style Element	Suggested use
Intro 1	Intro with prerecorded chord sequence and melody
Intro 2	Intro with chord recognized on the keyboard
Intro 3	Usually a one-measure Count In

1 Press one of the **VARIATION** buttons on the control panel to choose the Variation you want to use for the first verse. The button's indicator will be on, meaning the Variation is waiting to start.



2 Press one of the **INTRO** buttons on the control panel to 'book' one of the Intro sections. The button's indicator will be on, meaning the Intro is waiting to start. The button's indicator on the selected **VARIATION** button will be flashing, meaning it is booked after the Intro.



3 Start the accompaniment.

Choosing a Variation to play a Verse or Chorus

Variations can be used for verses, choruses, bridges or specials. To choose the right Variation for your verse, please note that Variations are of growing 'density' and 'loudness'. This means that **Variation 1** will be the 'sparsest' and the 'quietest' of the arrangements, while **Variation 4** will be the 'densest' and 'loudest' of them. Usually, you will use Variation 1 for the first verse, Variation 4 for the last chorus.

Style Element	Suggested use
Variation 1	Verse, Bridge, Chorus or Special (lowest density)
Variation 2	Verse, Bridge, Chorus or Special (medium-low density)
Variation 3	Verse, Bridge, Chorus or Special (medium-high density)
Variation 4	Verse, Bridge, Chorus or Special (highest density)

- > Wait for the Intro to end playing, and then the selected Variation will start playing. The selected **VARIATION** indicator will stay lit.



- > As an alternative, you can start the Variation before the end of the Intro. While the Intro is playing, press one of the **VARIATION** buttons. The Variation will start at the next measure.

Choosing a Fill

Fills are phrases that can be used for smoothly bridging between different sections of a song. Their density is similar to that of the same numbered Variations.

Style Element	Suggested use
Fill 1	Fill (lowest density)
Fill 2	Fill (medium-low density)
Fill 3	Fill (medium-high density)
Fill 4	Fill (highest density)

■ Manually selecting a Fill

You can directly choose a Fill.

1 When you want to choose a Fill, press one of the **FILL** buttons to choose the Fill you want to play. The button's indicator will be on while the Fill is playing.



2 If you want, choose a different Variation before the end of the Fill.

■ Automatically selecting a Fill

If you like, you can let Pa5X automatically select a Fill when you choose a Variation.

1 Press the **AUTO FILL** button to light up its indicator.



2 Press one of the **VARIATION** buttons. A Fill will be automatically selected.



3 When you no longer need this function, press the **AUTO FILL** button again to turn the indicator off.

Programming the Auto Fill

You can program how the **Auto Fill** works.

1 Go to the **Settings > Menu > Preferences > Style** page.

As an alternative, keep the **SHIFT** button pressed and press the **PLAYER > STYLE** button to open the **Style** page.



> Use the **Auto Fill mode** menu to choose the Auto Fill mode.

Auto Fill Mode	Meaning
Current Variation	The Fill with the same number of the previous Variation will be automatically selected. For example, if you are going from Variation 2 to Variation 3, Fill 2 will be automatically selected.
Target Variation	The Fill with the same number of the target Variation will be automatically selected. For example, if you are going from Variation 2 to Variation 3, Fill 3 will be automatically selected.
Smart	Auto Fill tries to make the transition smoother. For example, if you are going from Variation 1 to Variation 4, Fill 3 will be automatically selected.

2 Press the **EXIT** button to return to the previous page.

Choosing a Break

A break introduces a short pause in your song, creating a suspension and a sense of surprise.

Style Element	Suggested use
Break	One-measure break

- When the Variation is nearing its end, press the **BREAK** button to play a short musical break.



Choosing an Ending

To choose the right Ending for your song, please note that **Ending 1** plays a pattern with a prerecorded chord sequence and melody, while **Ending 2** plays on the chord recognized on the keyboard.

Style Element	Suggested use
Ending 1	Ending with prerecorded chord sequence and melody. It will start at the next measure.
Ending 2	Ending with the chord recognized on the keyboard. It will start at the next measure.
Ending 3	Two-measure Ending, starting immediately, without waiting for the measure to end.

- When it is time to end the song, press one of the **ENDING** buttons on the control panel to 'book' one of the Ending sections.



After the Ending, the Style will automatically stop.

Looping sections

If you feel that an Intro, a Fill, a Break or Ending should last longer than the recorded pattern, you can let it enter a cycling loop.

■ Set a Style Element to loop

- > Press twice the button of the Intro, Fill, Break or Ending to loop.

The indicator on the button will start flashing, and the pattern will start repeating.

■ Exit from the loop

Do one of the following:

- > Press the same Style Element button again, or
- > Select a different Style Element.

Choosing the Style Elements from the display

You can select the Style Elements from the **Style Elements** page on the display. This page allows for some different ways of working.

- > The **STYLE ELEMENT** buttons on the control panel let you quickly access the Style Elements of the current Player. You can still access the Elements while, for example, reading the Lyrics on the display.
- > The **Style Elements** page allows to select the Elements for the current Player, but also allows for pre-selecting Elements in the other Player while not yet selected. If a MIDI Song is assigned to the other Player, you will be able to pre-select Song Markers instead.

■ Access the Style Elements page

- 1 Assign a Style to one or both Players.
- 2 Press the **STYLE ELEMENT / MARKER** button to open the **Style Elements** page.

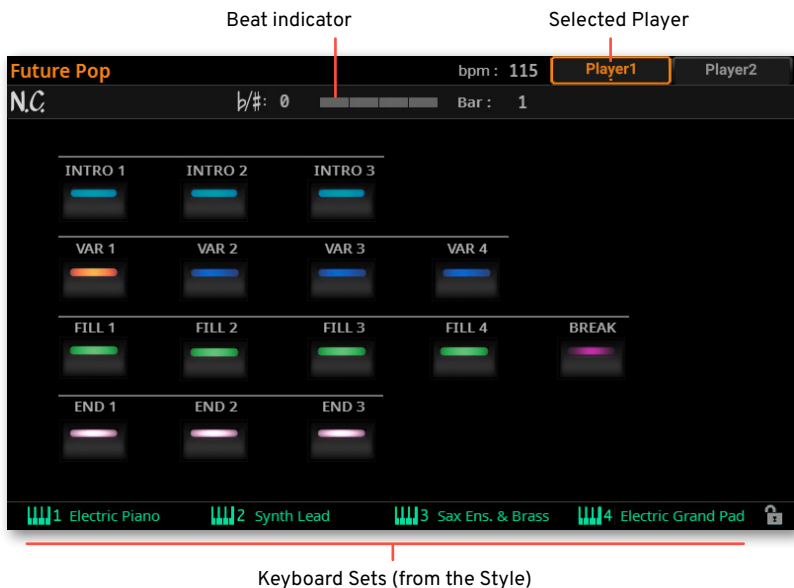

When accessing this page, the current Player appears selected on top of the page. If it is playing, you can see it progressing in the **beat indicator**.

■ Select a Style Element in the current Player

> While the Style Elements of the **current Player** appear in the display, touch one of them to select it. This is the equivalent of the **STYLE ELEMENT** buttons on the control panel.

■ Pre-select a Style Element in the other Player

1 Touch the button corresponding to the **other Player** on top of the page.

If the other Player has a MIDI Song assigned, the corresponding page will show the Markers instead of the Style Elements.

When switching to the other Player, the **beat indicator** will show the activity of the newly selected Player. If it is in stop, there will be no activity shown.

2 Choose one of the **Style Elements** from the other Player to pre-select it.

3 When moving the **X-FADER** to select the other Player, you will find the selected Element ready to play.

4 If the newly selected Player is stopped, press the corresponding **PLAY/STOP (▷□)** button to start it.

You can see the activity of the selected Player in the **beat indicator**.

5 If you want, press the **PLAY/STOP (▷□)** button corresponding to the older Player to stop it.

Fade In/Out

Using the Fade button

You can use the **FADE** button to start and/or stop your playing with a smooth fade-in or out.



■ Fade in

> While the Style is not playing, press the **FADE** button to light up its indicator and start the Style with a smooth fade-in.

The Style will start. When the maximum volume is reached, the indicator will turn off.

■ Fade out

> When the song is approaching its end, press the **FADE** button to stop the Style with a smooth fade-out.

Setting the Fade time

> Go to the **Settings > Menu > General Controls > Basic** page to set the Fade In and Fade Out time.

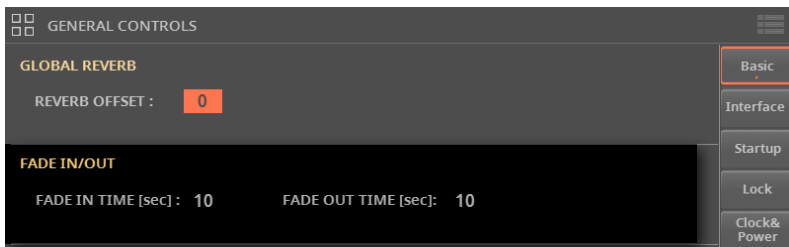

Setting the Style play controls

Choosing where to play chords (Chord Scan area)

You can play chords with your left or right hand separately, or with both hands. You can choose the recognition area, depending on the song you are playing and your preferred playing style.

The area where chords are recognized depends on the status of the **CHORD** indicators.

CHORD	Where to play chords (Chord Scan area)	Notes to play
LOWER	Left hand (Lower area of the keyboard)	Depends on the Chord Recognition mode
UPPER	Right hand (Upper area of the keyboard)	Three or more
LOWER+UPPER	Both hands (full keyboard)	Three or more
Off	No chord recognized	-

■ Make chords be recognized when played with your left hand

> Press the **CHORD > LOWER** button to turn its indicator on.

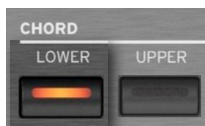

The number of notes to be played, for a chord to be recognized, depends on the Chord Recognition mode (see below).

■ Make chords be recognized when played with your right hand

- 1 Press the **CHORD > UPPER** button to turn its indicator on.

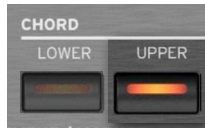

- 2 Always play three or more notes to let the arranger recognize a chord.

■ Make chords be recognized when played with both hands

- 1 Press both the **CHORD (LOWER+UPPER)** buttons to turn their indicators on.

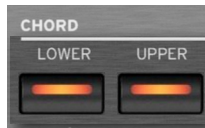

- 2 Always play three or more notes to let the arranger recognize a chord.

■ Deactivate chord recognition

- 1 Press both the **CHORD (LOWER+UPPER)** buttons to turn their indicators off.



- 2 Only the Drum and Percussion tracks will continue to play.

■ Memorize the Chord Scan area

- > Save a User Keyboard Set.

Choosing how to play chords (Chord Recognition mode)

You can play chords in the simplest (even simplified), or the most sophisticated way. It's at you how chords have to be played to be recognized.

1 Go to the **Settings > Menu > Preferences > Style** page.

As an alternative, keep the **SHIFT** button pressed and press the **PLAYER > STYLE** button to open the **Style** page.

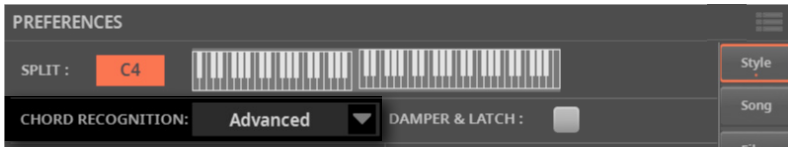

2 Choose how to play chords by using the **Chord Recognition** menu.

Chord Recognition	How to play chords
One Finger	<p>This mode is only available when the SPLIT indicator is turned on. If you turn it off, the mode will automatically switch to Fingered (3 Notes).</p> <p>With this mode, you can compose a chord using a simplified chord playing technique:</p> <ul style="list-style-type: none"> • Play a single note for a Major chord to be recognized. • Play the root note, plus a white key on the left, for a 7th. For example, play C3 + B2 for a C7. • Play the root note, plus a black key on the left, for a Minor chord. For example, play C3 + Bb2 for a C minor. • Play the root note, plus a white and a black key on the left, for a Minor 7th. For example, play C3 + B2 + Bb2 for a C min 7.
One Finger Plus	<p>This mode works like One Finger. However, if you play complete chords, it will recognize them as if you were in Fingered (3 Notes). This way, you can play chords that One Finger cannot recognize.</p>
Fingered (1 Note)	<p>When the SPLIT indicator is turned on, play one or more notes to compose a chord. A full Major chord will be recognized even if only a single note is played.</p> <p>When the SPLIT indicator is turned off, play at least three notes to compose a chord.</p>
Fingered (3 Notes)	<p>Always play three or more notes for a chord to be recognized.</p>

Chord Recognition**How to play chords**

Advanced

When the SPLIT indicator is turned on, play one or more notes for a chord to be recognized. If you play a single note, a 'root+8ve' will be played. If you play a fifth, a 'root+5th' chord will be played.

When the SPLIT indicator is turned off, play at least three notes to compose a chord.

With this mode, you can play rootless and slashed chords, often used in jazz, fusion or modern pop. You don't always need to play the root note, that would otherwise double the note already played by the bassist.

3 Press the **EXIT** button to return to the previous page.

Keeping a chord in memory by pressing the Damper pedal

You can choose to keep the recognized chord in memory while the Damper pedal is kept pressed. In this case, you can freely play any chord on the keyboard, and the Style will continue to play the ‘latched’ chord. This is especially useful when playing in Full Keyboard mode (with the **SPLIT** indicator turned off), and you would risk that all the notes played on the keyboard are recognized as a new chord.

1 Go to the **Settings > Menu > Preferences > Style** page.

As an alternative, keep the **SHIFT** button pressed and press the **PLAYER > STYLE** button to open the **Style** page.

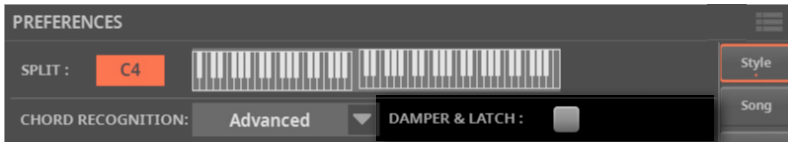

2 Select the **Damper&Latch** checkbox, to make the recognized chord be held for as long as the Damper pedal is kept pressed.

At this point, play a chord for the Style. Press the Damper pedal and keep it pressed to keep the recognized chord in memory. Release the Damper pedal when you want to play another chord to be recognized by the Style.

Holding chords and Lower notes (Memory)

Using the Memory function

You can keep the chords and/or Lower notes in memory even after raising your hand from the keyboard. How this function works depends on the settings of the **Memory Mode** parameter (see below).



- > Press the **MEMORY** button to turn its indicator on, and keep the chords and/or Lower notes in memory.
- > Press the **MEMORY** button to turn its indicator off. The chords and/or Lower notes are released as soon as you raise your hand from the keyboard.

Choosing the Memory Mode

Set how the **MEMORY** button works according to your preferences.

- 1 Go to the **Settings > Menu > Preferences > Style** page.

As an alternative, keep the **SHIFT** button pressed and press the **PLAYER > STYLE** button to open the **Style 1** page.

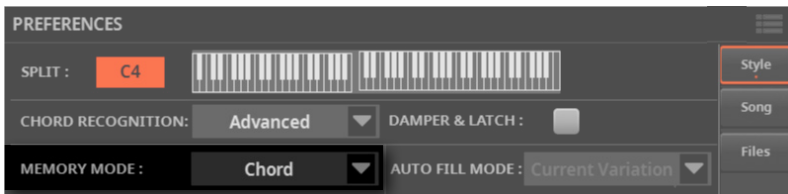

2 Use the **Memory Mode** parameter to choose the way the **MEMORY** button works.

Memory Mode	Meaning
Chord	When the MEMORY indicator is on, recognized chords are held even when raising your hand from the keyboard. When the indicator is off, chords are reset when raising your hand.
Chord + Lower	When the MEMORY indicator is on, recognized chords and the Lower Sound are held until the next note or chord is played. When the indicator is off, both the chord (therefore the accompaniment) and Lower Sound are cut when raising the hand from the keyboard.
Fixed Arr. + Lower	When the MEMORY indicator is on, recognized chords and the Lower Sound are held until the next note or chord is played. When the indicator is off, the Lower Sound is cut when raising the hand from the keyboard, while the chord is held (the accompaniment will continue to play).

Bass inversion and slashed chords

The arranger recognizes chords by analyzing all the notes you play in the chord recognition area, and evaluating their function in a chord. You can, however, always force the lowest (leftmost) note of the chord to be considered as something special, for example the chord's root of a slashed chord (such as 'C/E' or 'F/C').

As per factory programming, this function is assigned to **CONTROL > BUTTON #6** when in **USER** mode.

■ Access the Bass Inversion function from the control panel

- 1 Press the **USER** button in the **CONTROL** section.
- 2 Check in the **strip display** the functions assigned to the buttons. If they are not shown, press the **VIEW** button in the **CONTROL** section to see them.



■ Access the Bass Inversion function from the display

- > Go to the **Home > Control > User** pane.

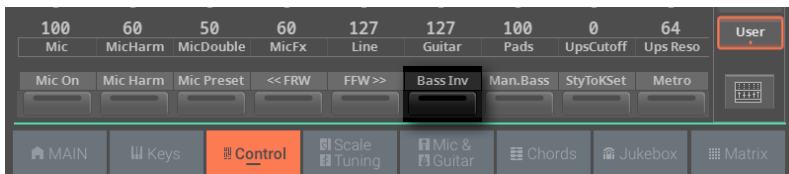

■ Turn the Bass Inversion function on

- > Use the **Bass Inversion** switch to activate the function.

The lowest note of a chord will always be detected as the root note.

■ Turn the Bass Inversion function off

- > Use the **Bass Inversion** switch to deactivate the function.

The lowest note will be scanned together with the other chord notes, and will not always be considered as the root note.

Playing a manual bass line

You can play the Bass Sound with your left hand, freeing it from the automatic accompaniment.

This function is assigned to **CONTROL > BUTTON #9** when in **MAIN** mode. As per factory programming, it is also assigned to **CONTROL > BUTTON #7** when in **USER** mode.

■ Access the Manual Bass function from the control panel

- 1 Press the **MAIN** button in the **CONTROL** section.
- 2 Check in the **strip display** the functions assigned to the buttons. If they are not shown, press the **VIEW** button in the **CONTROL** section to see them.

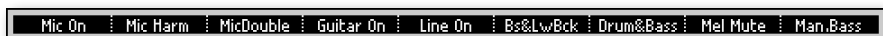

■ Access the Manual Bass function from the display

- > Go to the **Home > Control > Main** pane.

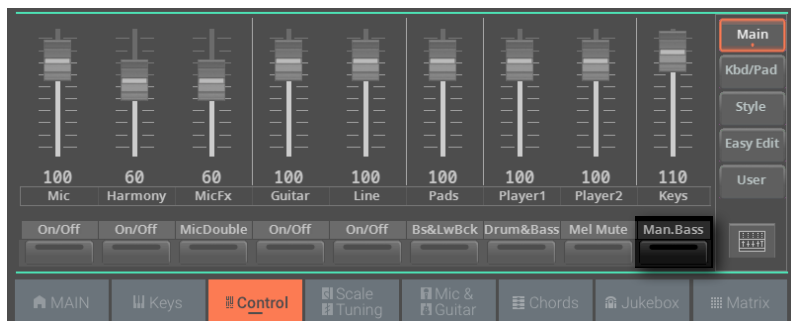

■ Turn the Manual Bass function on

- > Use the **Manual Bass** switch to activate the function.

The automatic accompaniment will stop playing (except for the Drum and Percussion Sounds), and you can manually play the Bass line on the Lower part of the keyboard.

When in Manual Bass mode, the volume level of the Bass Sound will be automatically increased.

■ Turn the Manual Bass function off

- > Use the **Manual Bass** switch to deactivate the function.

When turning the Manual Bass mode off, the volume level of the Bass Sound will be automatically set back to the original value.

HINT: You can turn Manual Bass on and choose the Upper Chord Scan mode. This way, you can send chords to the Style with your right hand, while playing the bass freely with your left hand.

Controlling the Style with dynamics

You can play stronger than a set velocity value to trigger a Style control.

1 Go to the **Settings > Menu > Preferences > Style** page.

As an alternative, keep the **SHIFT** button pressed and press the **PLAYER > STYLE** button to open the **Style** page.



2 Use the **Velocity Control** parameter to choose the function to be controlled when playing strongly.

Velocity Control	Meaning
Off	The function is turned off.
Break	When playing with a velocity higher than the trigger value on the Lower track, the Break is automatically triggered.
Start/Stop	You can start or stop the Style by playing harder on the keyboard.
Bass Inversion	When playing with a velocity higher than the trigger value, the Bass Inversion function will be activated or deactivated.
Memory	When playing with a velocity higher than the trigger value, the Memory function will be activated or deactivated.

3 Use the **Value** parameter to set the velocity trigger value.

4 Before using this function, be sure the **SPLIT** indicator is turned on.

Playing a Bass & Lower Backing

You can play a sparser manual accompaniment, where the chord you play with your left hand is split between the Bass (chord root) and Lower (the remaining notes) Sounds.

This function is assigned to **CONTROL > BUTTON #6** when in **MAIN** mode.

Turning the Bass & Lower Backing function on or off

■ Access the Bass & Lower Backing function from the control panel

- 1 Press the **MAIN** button in the **CONTROL** section.
- 2 Check in the **strip display** the functions assigned to the buttons. If they are not shown, press the **VIEW** button in the **CONTROL** section to see them.



■ Access the Manual Bass function from the display

- > Go to the **Home > Control > Main** pane.

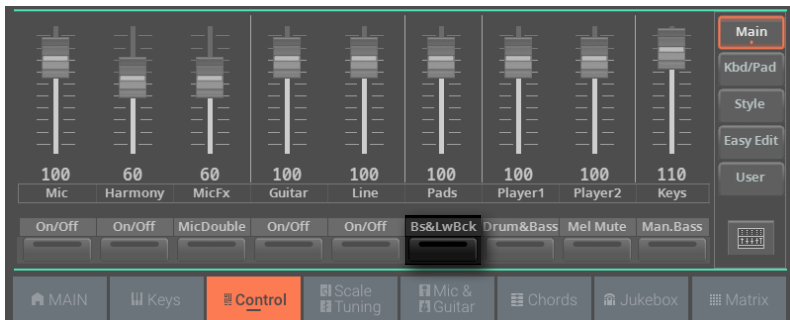

■ Turn the Bass & Lower Backing function on/off from the Control section

- > Use the **Bass & Lower Backing** switch to activate or deactivate the function.

■ Turn the Bass & Lower Backing function on/off from the Settings

1 Go to the **Settings > Menu > Preferences > Style** page.

As an alternative, keep the **SHIFT** button pressed and press the **PLAYER > STYLE** button to open the **Style** page.



2 Select or deselect the **Bass & Lower Backing** checkbox to activate or deactivate the function.

3 Press the **SPLIT** button to turn its indicator on.

With the Split enabled, the **Bass & Lower** indication will appear in the **Home > Main** page.

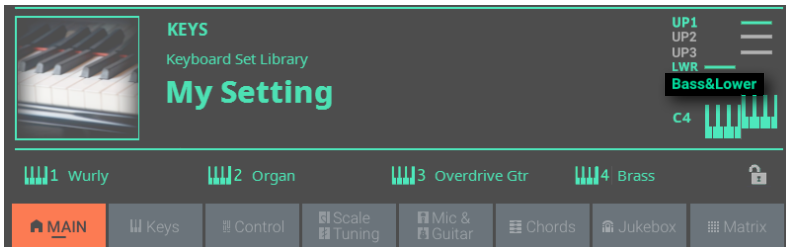

Playing the manual accompaniment

1 Be sure the **Bass & Lower Backing** function is active (the **Bass & Lower** indication appears in the **Home > Main** page, see above).

2 Be sure the **SPLIT** indicator is turned on, and the Style is not running.

3 Play a chord sequence with your left hand.

Notice how the chord root is played by the Bass Sound, while the remaining chord notes are played by the Lower Sound (even if it is muted).

Adjusting the volume of the grouped Style Sounds

You can set a global volume setting for the grouped Style Sounds. Being global, this will not change when choosing a different Style. To avoid abrupt changes in the volume level of the Style Sounds during a show, we moved the volume settings to a safer area than the **Home** page.

- 1 Go to the **Settings > Menu > Preferences > Style** page.

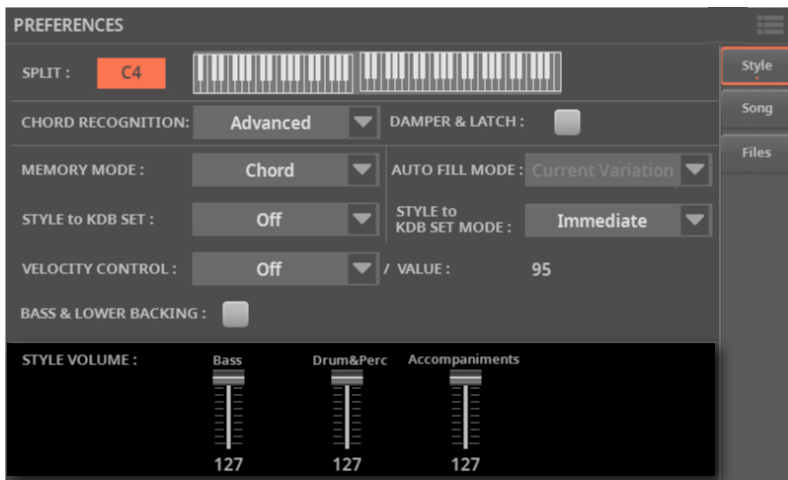

- 2 In the **Style Volume** section, touch the **mixer group channel** whose volume level you want to change.

Grouped part name	Meaning
Bass	Bass track (volume offset)
Drum&Perc	Grouped Drum and Percussion tracks (volume offset)
Accompaniment	Grouped Accompaniment tracks (Acc1-5) (volume offset)

- 3 Keep the **virtual volume slider** held on the screen, and drag it to the desired level.

As it happens with the groups of a mixer, these levels are not the actual channel level, but a global offset added to the separate channels. Therefore, the resulting level will depend on the individual level of each channel, summed to this group's offset.

If you like, you can finely mix the various groups. For example, if you prefer Drums and Bass to be more prominent to let them have more 'punch', you can lower the grouped Style Sounds to leave more room to the rhythm section.

If you wish to permanently mute a group, just move its volume to zero.

The (relative) volume level of grouped tracks will remain the same for all the subsequent Styles you will choose during your performance.

4 Press the **EXIT** button to return to the previous page.

Choosing a Fill Mode for each Fill/Break

The Fill Mode parameters allow for automatically choosing a Variation at the end of each Fill, after having pressed one of the **FILL** or **BREAK** buttons. These settings can be saved to a Style or a SongBook Entry, so you can have a different Fill Mode configuration for each Style or Song in a SongBook Entry.

- 1 Go to the **Home > Menu > Style Controls > Fill Mode** page.



As an alternative, you can access these parameters in the **Style Edit > Menu > Style Controls > Fill Mode** page.

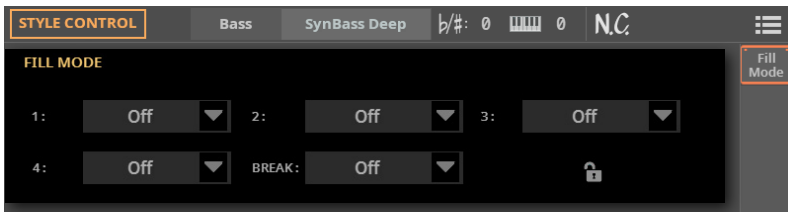

- 2 Use the **Fill Mode > 1...5/Brk** pop-up menus to choose a Fill Mode for the corresponding Fill/Break.

Fill Mode	Meaning
Off	The same Variation, playing before selecting a Fill, will be selected again.
1&2 ... 3&4	The specified Variations will be alternatively selected, when one of them is selected. For example, with the 1&2 option, if Variation 1 is selected, Variation 1 and Variation 2 will be alternatively selected after the end of the Fill.
Up/Down	The next higher/lower numbered Variation is selected, in cycle. After Variation 4, an Up command will select Variation 1. After Variation 1, a Down command will select Variation 4.
Increase/Decrease	The next higher/lower numbered Variation is selected. When Variation 4 is reached, an Inc command will select Variation 4 again. When Variation 1 is reached, a Dec command will select Variation 1 again.
Variation 1 ... 4	Fill to Variation (→1, →2, →3, →4) automatically selects one of the four available Style Variations at the end of the fill.

Auto Fill and Fill Mode

Auto Fill and **Fill Mode** can interact, by doing strictly related things:

- > When the **Auto Fill** is enabled (**AUTO FILL** indicator on), you can choose a Variation by pressing one of the **VARIATION** buttons. This will automatically select a Fill, then the chosen Variation. This is the easiest way to select the Variation best fitting the next song section, and let the instrument automatically choose a Fill for you.
- > When the **Fill Mode** is programmed in a Style or SongBook Entry, you can choose a Fill or Break by pressing one of the **FILL** or **BREAK** buttons. The chosen Fill or Break will be played back, then the programmed Variation will be automatically selected. This is a sophisticated way of creating complex pattern patterns of Fills and Variations.

Please note that, while **Auto Fill** is a global setting, **Fill Mode** is tied to a Style or SongBook Entry.

07

Playing the Pads

The Pads

What is a Pad?

Pads are single-track hits (One Shot type) or cycling sequences (Loop type), that you can instantly play with the dedicated **PADS** buttons, the **Pad** buttons in the **Home > Main** page, or with the **MATRIX** buttons.

A maximum of four Pads can play at the same time in a Player. Loop-type Pads play in time with the Style or the MIDI Song. They are transposed according to the recognized chords.

Choosing a combination of Pads

Each of the Players can have its own set of four Pads. A set of Pads can be recalled by a Style or a SongBook Entry.

■ Choose the Pads by selecting a Style

- > Choose a Style. The four Pads it contains will be recalled.

■ Choose the Pads by selecting a SongBook Entry

- > Choose a SongBook Entry (either based on a Style or a Song). The four Pads it contains will be recalled.

Playing the Pads

Playing the Pads

Starting and stopping the Pads

You can play up to four Pads at the same time, by using the dedicated **PADS** buttons, the **Pad** buttons in the **Home > Main** page on the display, or the assigned **MATRIX** buttons.

Pads of the One Shot type automatically stop at the end of the sequence. Pads of the Loop type continue cycling until you don't stop them.

■ Play and stop the Pads from the PAD section

1 Press the **PAD** button corresponding to the Pad to play. You can also start more Pads at the same time.



The indicators of the Pads that are playing will turn on. Also, the **Pads playback indicators** in the display will be shown running (see below).

- 2** Press the **PAD** button(s) you want to stop.
- 3** Press the **PAD > STOP** button to stop all the Pads.

■ Play and stop the Pads from the Main page

- 1 Go to the **Home > Main** page.
- 2 Touch the **Pad** button corresponding to the Pad to play. You can't start more Pads at the same time from the display, but you can start other Pads after the first one.

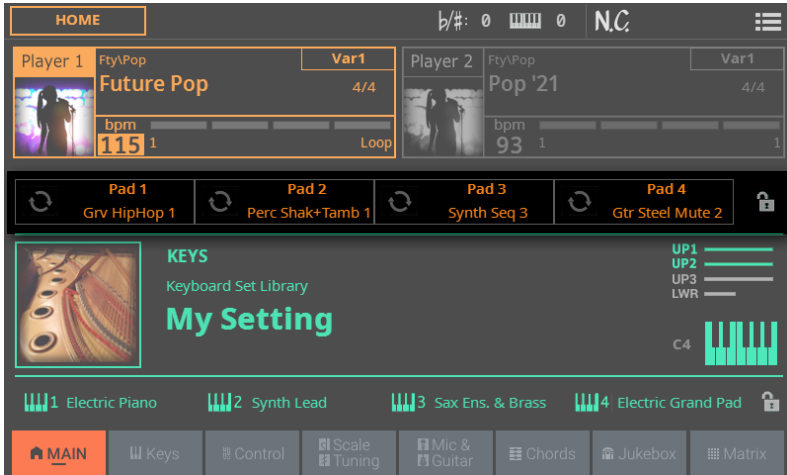

The indicators of the Pads playing will turn on in the **PAD** section on the control panel. Also, the **Pads playback indicators** in the display will be shown running.



You can play **Loop-type** (↺) or **One Shot-type** (→) Pads.

- 3 Touch the **Pad** button(s) you want to stop, or press one of the buttons in the **PAD** section on the control panel.
- 4 Press the **PAD > STOP** button to stop all the Pads.

■ Stop all the Pads together with the Style or Song

- > Press the **PLAY/STOP** (▷◻) button, the **STOP/GO TO START** (⏮) button.

■ Transpose the Pads

- > Play some chords, and transpose any pitched sequence in a Pad.

Changing Tempo

Pads are always synchronized to the Tempo of the selected Player. Change the **Player's Tempo**, and the Pads' Tempo will change accordingly.

Customizing the Pad set

Choosing the individual Pads

Every Factory and User Style, as well as each SongBook Entry, has its own four Pads. You can save a new combination of Pads into a User Style or SongBook Entry.

Choosing the Pads

- Open the Select window

- 1 Go to the **Home > Menu > Pads** page.

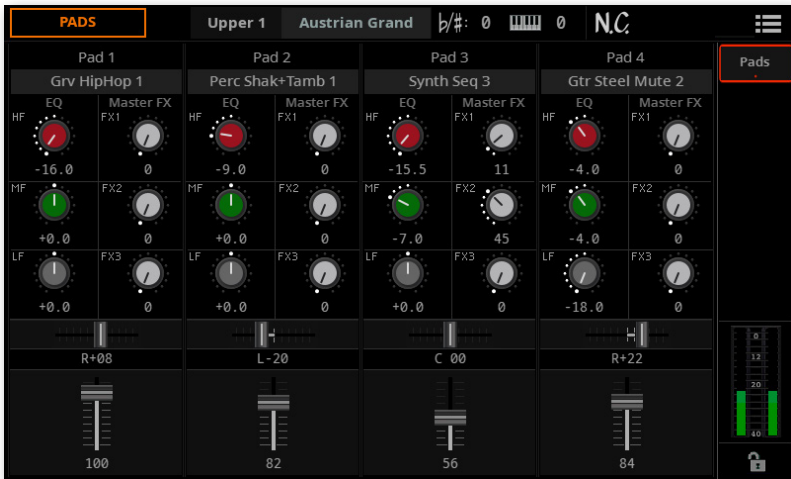

- 2 Touch the **name of the Pad** you want to change to open the **Select** window.

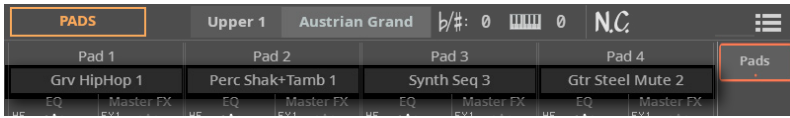

Choose a Pad

- 1 Browse through the Pads in the **Pad Select** window.

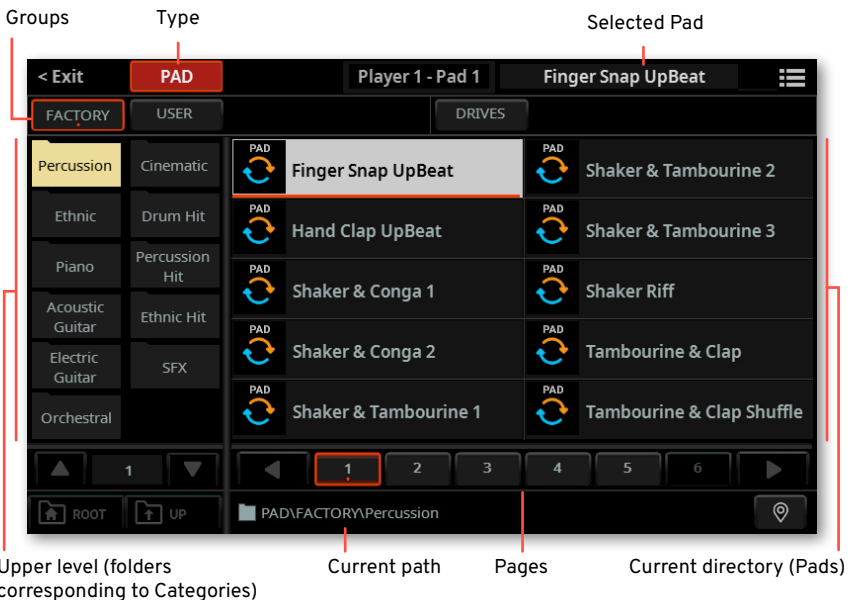

- 2 To choose one of the available **groups** from which to choose a Pad, touch the **buttons** in the second line at the top of the window.



Group	Meaning
Factory	Pads included in the Factory library, that can't be modified or overwritten.
User	Internal memory area where you can save new or edited Pads, or where you can copy Pads from an external storage device.
Drives	Pads accessed from an external storage device. You can organize them freely, as if they were ordinary files.

3 If you are choosing from the **Drives**, choose one of the available **storage devices (drives)**, in the left side of the display, then browse through the folders inside the **selected drive**.

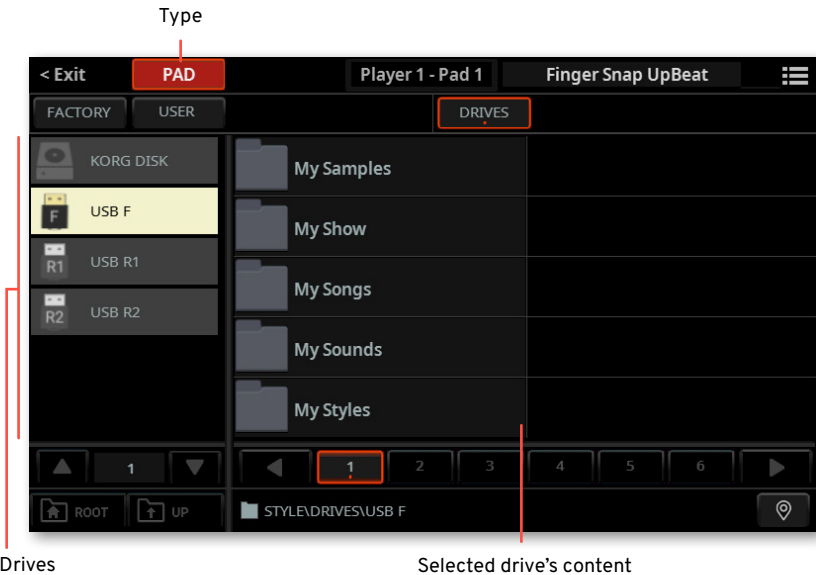

Drive	Meaning
KORG DISK	Storage space inside the internal drive (separate from the User area)
SD USER	Storage space inside the (optional) SD card
USB F	Storage device connected to the front USB HOST port
USB R1	Storage device connected to the rear USB HOST 1 port
USB R2	Storage device connected to the rear USB HOST 2 port

4 If you are choosing from the **Factory** or **User** banks, you will find the Pads organized in **categories** (shown as folders). If you want to choose a different category, touch one of the category folders in the left side of the **Pad Select** window.

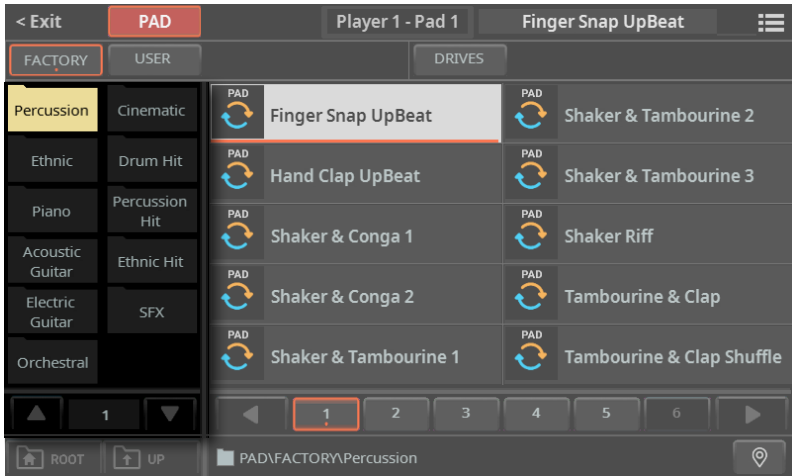

5 The Pads contained in the selected folder will appear in the right side of the window.

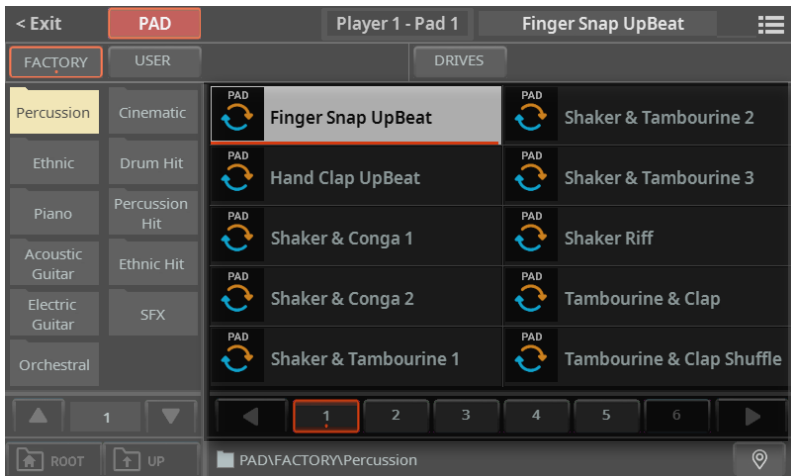

Pads can be of **Loop-type** (🔄) or **One Shot-type** (→).

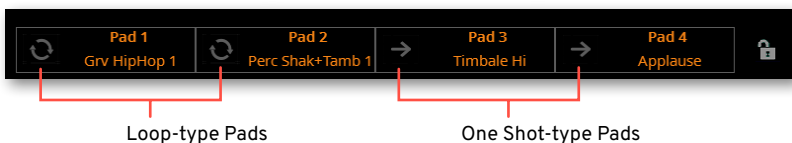

- 6 If you are lost while browsing through the data, you can return to the folder containing the selected element by touching the **Locate** (📍) button.
- 7 Touch the **name of the Pad** you want to choose.
- 8 If you want to close the **Select** window (and it does not close by itself), press the **EXIT** button.

HINT: When a window does not close by itself, it means the **Display Hold** is turned on. See **Display Hold** on page 67.

In the end, you will see the name of the selected Pad in the dedicated area of the **Home > Menu > Pads** page.

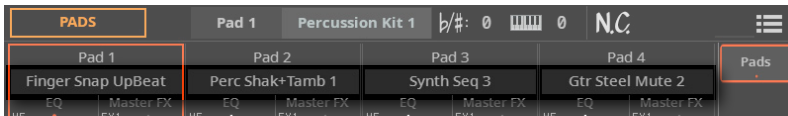

The name of the Pad will also appear in the **Home > Main** page.

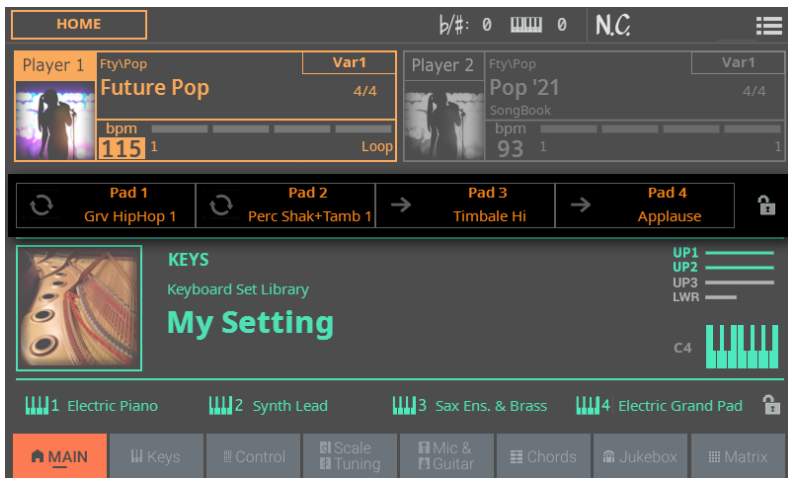

Saving the assigned Pads

- Save a User Style or a SongBook Entry.

Mixing the Pads

Editing the Pad parameters

- **Access the Pads page**
- > Go to the **Home > Menu > Pads** page.

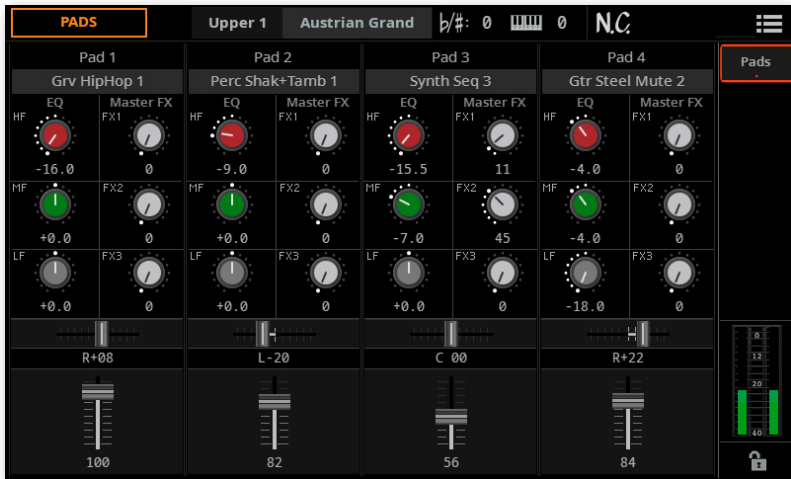

- **Adjust the volume and pan**

- > Use the **Volume** parameter (vertical sliders) to set the level of each Pad.

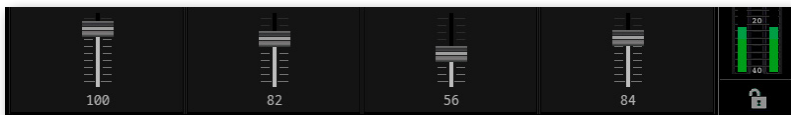

- > Use the **Pan** parameter (horizontal sliders) to set the position of each Pad in the stereo panorama.



■ Adjust the send level to the master effects

- > Use the **Master FX** parameters to adjust the amount of the signal sent to the FX 1, 2 and 3 Master effects (FX Group A).



The Master Effects are the ones of the Style the Pads are linked to.

■ Equalize the sound

- > Use the **EQ** gain controls to set the three-band equalizer for each Pad. Adjust the **HF** (High Frequencies), **MF** (Middle Frequencies) and **LF** (Low Frequencies) parameters as needed.



Saving the combination of Pads

- > Save a User Style or a SongBook Entry.

08

Playing the Chord Sequences

The Chord Sequences

Chord Sequences and the Styles

You can record a Chord Sequence, that will play the chords for you. This will be useful, for example, when you have to play a repeated sequence, and prefer to use your left hand to play a solo on the keyboard, or to select the DNC controllers.

Chord Sequences are individually contained in the Chord Sequence Library. All the supplied Styles and SongBook Entries already contain a Chord Sequence. A Chord Sequence can be memorized in the User library, in a User Style or a SongBook Entry.

Enabling the Chord Sequence

You can enable or disable the Chord Sequence by using the **SEQUENCE** button in the **CHORD** section in the control panel.



The SEQUENCE indicator shows the status of the Chord Sequences.

SEQUENCE	Meaning
Off	Chord Sequence not available.
White	Chord Sequence available, but not activate for playing.
Orange/Blue flashing	Chord Sequence available and ready to play in the corresponding Player (orange = Player 1, blue = Player 2).
Orange/Blue steady	Chord Sequence playing in the corresponding Player (orange = Player 1, blue = Player 2).

When you enable the Chord Sequence, the list of chords appears in the **Home > Chord** pane.



A Chord Sequence must be recalled by the Style or SongBook Entry, or chosen from the library. If it isn't, load it, as described below.

Choosing a Chord Sequence

Choosing a Chord Sequence from the library

Chord Sequences are contained in a dedicated library, that you can access from the **Home > Chords** page.

1 Be sure the **CHORDS > SEQUENCE** indicator on the control panel is showing the color of the Player (orange or blue), so that you can see the loaded Chord Sequence.

2 Go to the **Home > Chords page**, and touch the **name of the selected Chord Sequence**. If no Chord Sequence is already selected, the **Chords** label will appear instead of the name.

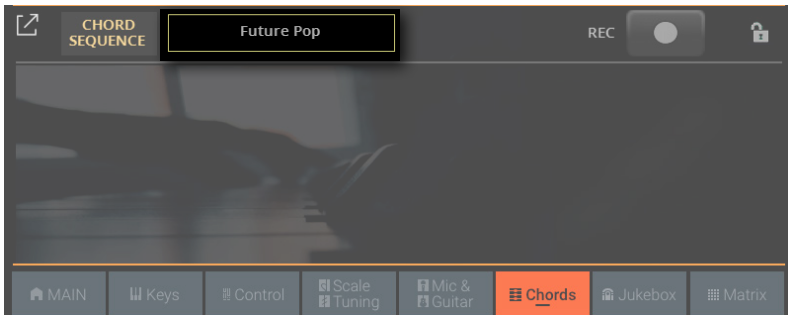

As soon as you touch the display, the **Chord Sequence Select** window appears.

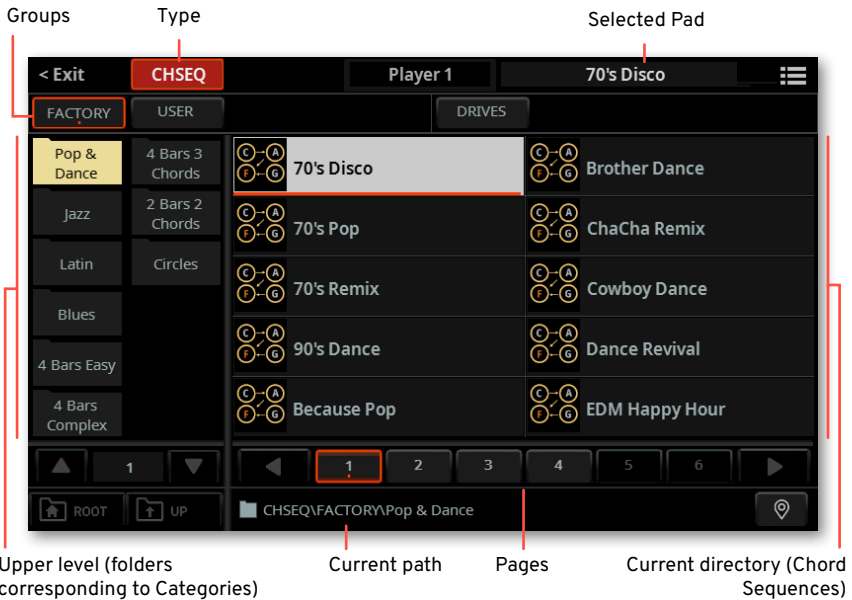

3 To choose one of the available **groups** from which to choose a Pad, touch the **buttons** in the second line at the top of the window.



Group	Meaning
Factory	Chord Sequences included at the factory, that can't be modified or overwritten.
User	Internal memory area where you can save new or edited Chord Sequences, or where you can copy Chord Sequences from an external storage device.
Drives	Chord Sequences accessed from an external storage device. You can organize them freely, as if they were ordinary files.

4 If you are choosing from the **Drives**, choose one of the available **storage devices (drives)**, in the left side of the display, then browse through the folders inside the **selected drive**.

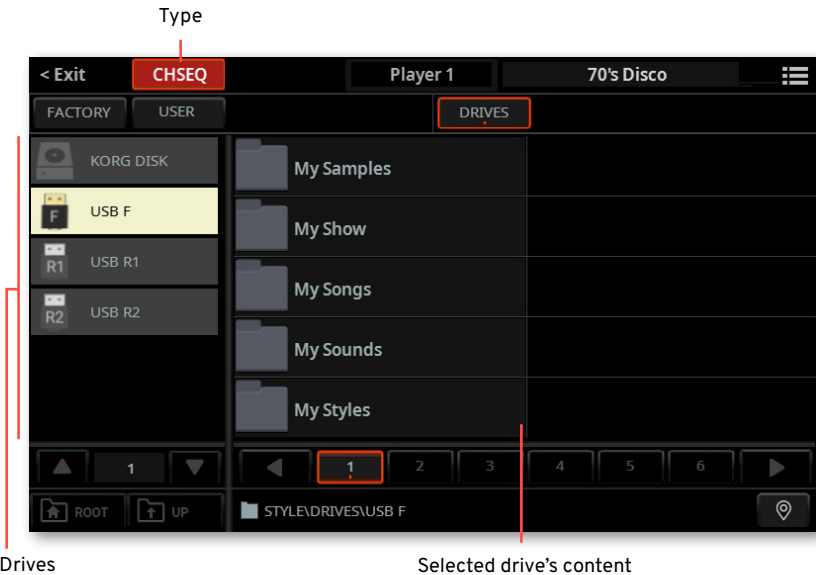

Drive	Meaning
KORG DISK	Storage space inside the internal drive (separate from the User area)
SD USER	Storage space inside the (optional) SD card
USB F	Storage device connected to the front USB HOST port
USB R1	Storage device connected to the rear USB HOST 1 port
USB R2	Storage device connected to the rear USB HOST 2 port

5 If you are choosing from the **Factory** or **User** banks, you will find the Chord Sequences organized in **categories** (shown as folders). If you want to choose a different category, touch one of the category folders in the left side of the **Chord Sequence Select** window.

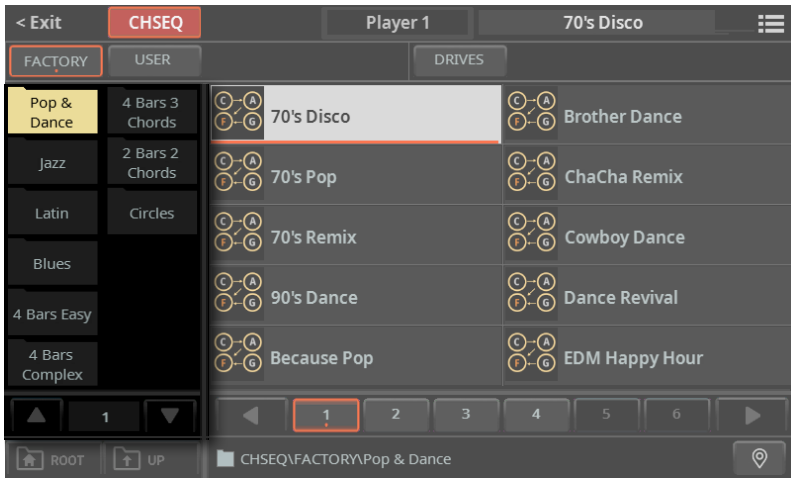

6 The Chord Sequences contained in the selected folder appear in the right side of the window. Touch the **name of the Chord Sequence** you want to choose.

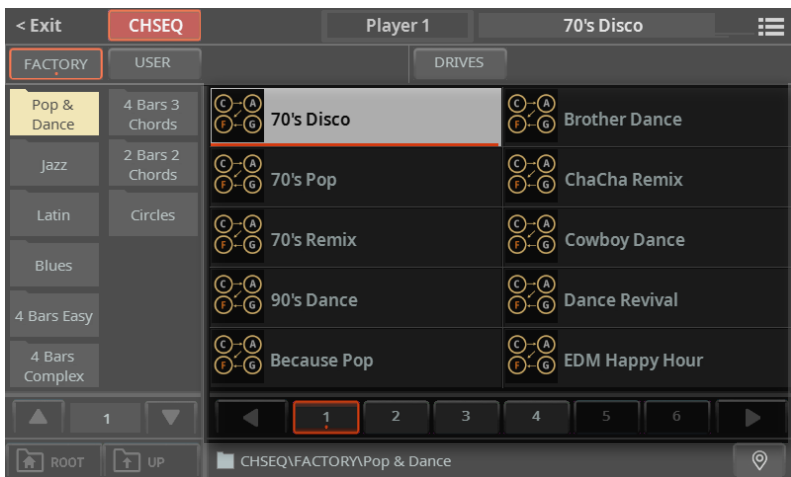

7 If you are lost while browsing through the data, you can return to the folder containing the selected element by touching the **Locate** (📍) button.

8 Touch the **name of the Chord Sequence** you want to choose.

9 If you want to close the **Select** window (and it does not close by itself), press the **EXIT** button.

HINT: When a window does not close by itself, it means the **Display Hold** is turned on. See **Display Hold** on page 67.

In the end, you will see the name of the selected Chord Sequence in the dedicated area of the **Main** page.



A list of chords will appear in the pane.



If the sequence is very long, you can touch the **Expand** (↗) button to see more chords.

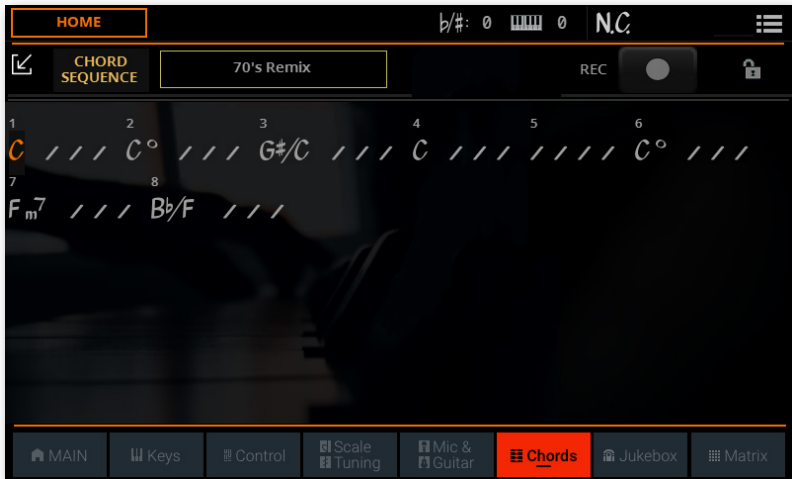

You can make the pane go back to the reduced size by touching the **Collapse** (↖) button.

Chord Sequences automatically selected by a Style or a SongBook Entry

When choosing a Style or a SongBook Entry containing a Chord Sequence, this is automatically recalled. Use the **CHORDS > SEQUENCE** button in the control panel to turn it on or off.

Locking the Chord Sequence

If you prefer to keep the current Chord Sequence, without letting a Style or SongBook Entry recall the memorized one, select the Chord Sequence lock.

> Go to the **Settings > Menu > General Controls > Lock** page, and select the **Style > Chord Sequence** checkbox.

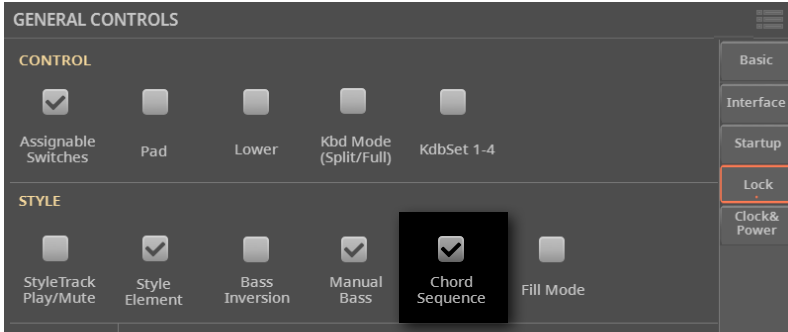

Playing the Chord Sequences

Starting and stopping a Chord Sequence

- 1 If a Chord Sequence is available but not activated, the **CHORD > SEQUENCE** indicator will appear white. If it is off, load a Chord Sequence as shown above.
- 2 Enable the Chord Sequence by pressing the **CHORD > SEQUENCE** button. If the Player is stopped, its indicator will start flashing with the color of the current Player. If it is playing, its indicator will be steady on.



- 3 Start the Player. The Chord Sequence will immediately start playing. If the Player was already running, the Chord Sequence will start playing from the next measure.
- 4 Play your solo part, while the Chord Sequence plays the chords for you. During Chord Sequence looping, you can freely select any Fill or Variation, as if you were playing chords with your hands.
- 5 Press the **CHORD > SEQUENCE** button again to disable the Chord Sequence. The button indicators will return white.

09

Playing the Songs

The Songs

What is a MIDI Song

MIDI Songs' technical name is Standard MIDI File, often abbreviated as SMF. The filename extension is .mid. The Standard MIDI File is the industry standard format for songs, and is used by Pa5X as the native file format when playing or recording MIDI Songs.

The MIDI Karaoke File (.kar) is an extension of the SMF format, and is also supported. It always contains lyrics.

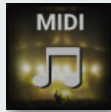

MIDI
Song



MIDI file on
disk



KAR file
on disk

What is an MP3 Song

MP3 Songs' technical name is MPEG Layer-3, usually abbreviated as MP3. The filename extension is .mp3. This is a compressed audio file, used to store recorded songs in the smallest amount of space, without losing too much audio quality. At the highest quality, MP3 files are usually impossible to distinguish from non-compressed audio files. Pa5X can play and record MP3 files.

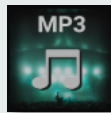

MP3
Song



MP3 file on
disk

Choosing the Songs

Choosing a Song

Songs can be either MIDI or MP3 Songs. You can play a Song with either Player 1 or Player 2. If you want, you can assign a Song to each of the players, and have the other player be ready for the next musical selection. You can also mix Styles and Songs with the different Players.

HINT: You can let the Players automatically choose a Song at startup. To choose which one(s), go to the **Settings > Menu > General Controls > Startup** page (see [Assigning startup elements to the Players](#) on page 431).

You can choose a Song from the control panel or from the display.

We'll assign a Song to Player 1. Instructions for Player 2 would be identical, apart for the different player.

-
- **Open the Select window from the control panel**
 - While in any page, press the **SONG** button in the **PLAYER 1** section.



■ Open the Select window from the display

- > Go to the **Home > Main** page.

When turning the instrument on, you are already in the **Main** page. If you are not in the **Main** page, press the **EXIT** button in the control panel.

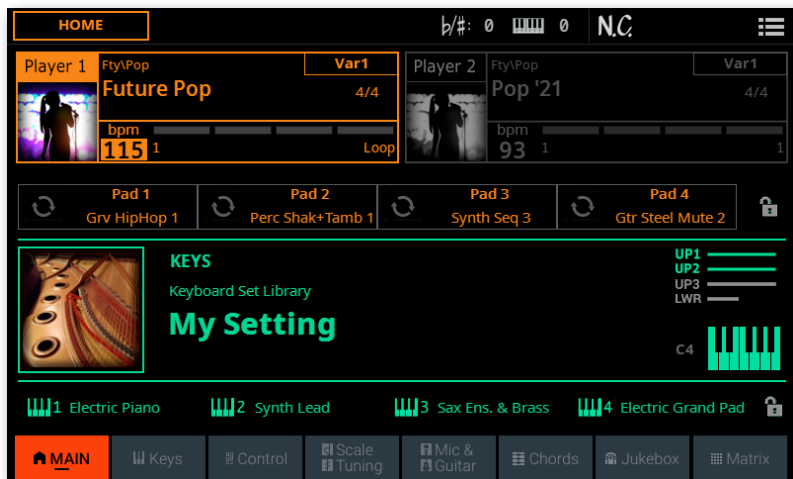

- > Touch the **name of the Song (or Style)** in the display.

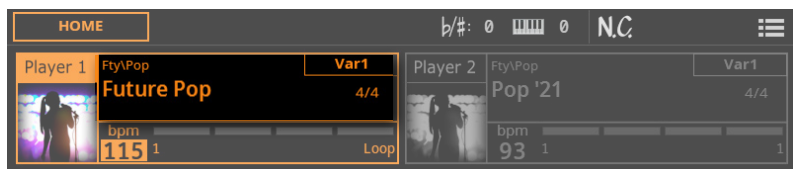

■ Choose a Song

- 1 Browse through the Songs in the **Select** window.

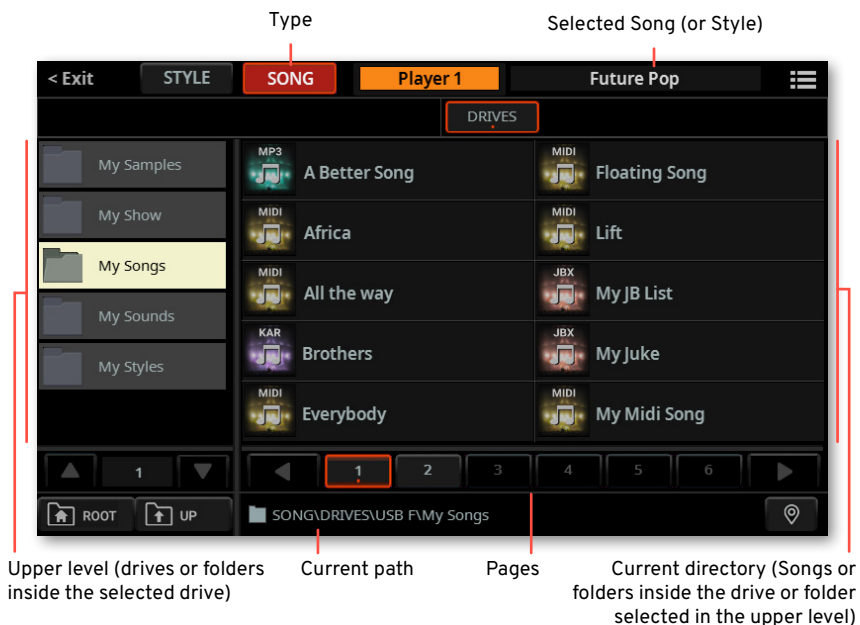

- 2 Be sure you are browsing the Songs, and not the Style. If not, touch the **SONG** button at the top of the window.



3 To choose one of the available **storage devices (drives)** from which to choose a Song, touch the **name of the drive** in the left side of the window.

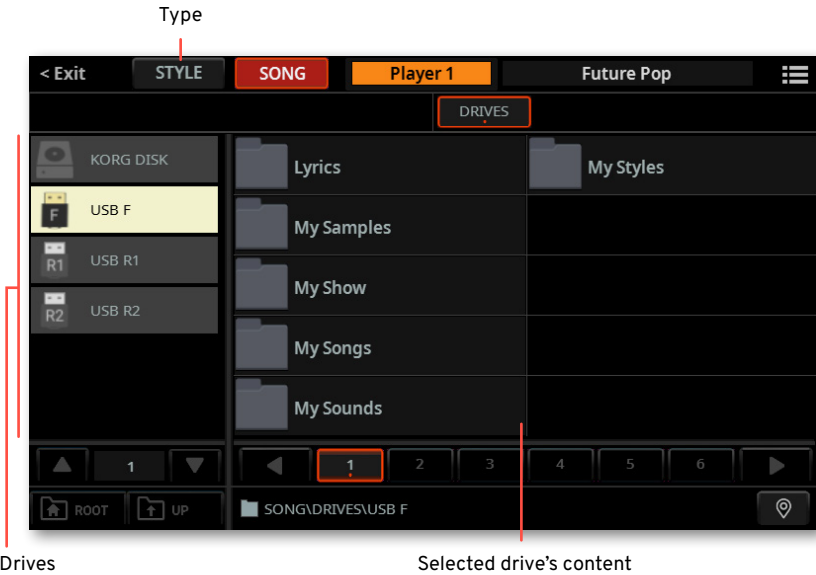

Drive	Meaning
KORG DISK	User storage space inside the internal drive
SD USER	User storage space inside the (optional) SD card
USB F	Storage device connected to the front USB HOST port
USB R1	Storage device connected to the rear USB HOST 1 port
USB R2	Storage device connected to the rear USB HOST 2 port

- 4 Select the **folder** containing the Song. Its content will appear in the right side of the window, and the containing folder will be moved to the left side.

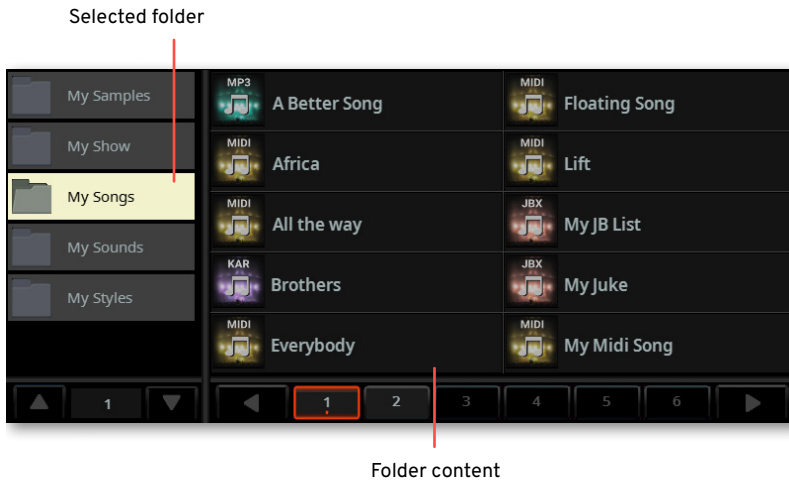

- 5 Browse through the folders. If you want to close the current folder and go up one level, touch the **Up** button. If you want to go up to the main directory of the drive, touch the **Root** button.

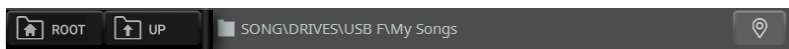

- 6 The Songs contained in the selected folder will appear in the right side of the window.

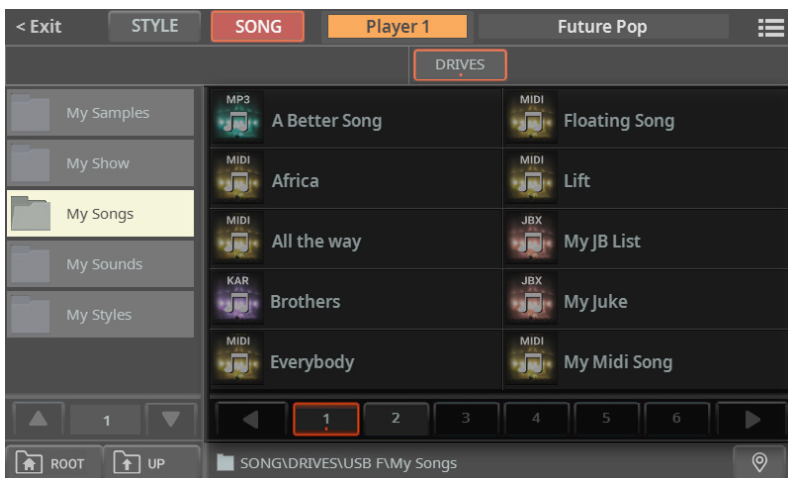

7 If you are lost while browsing through the data, you can return to the folder containing the selected element by touching the **Locate** (📍) button.

8 Touch the **name of the Song** you want to choose.

Once the Song has been selected, it will blink for a few seconds, and then be assigned to the selected Player. The selected file will appear highlighted in the list of files.

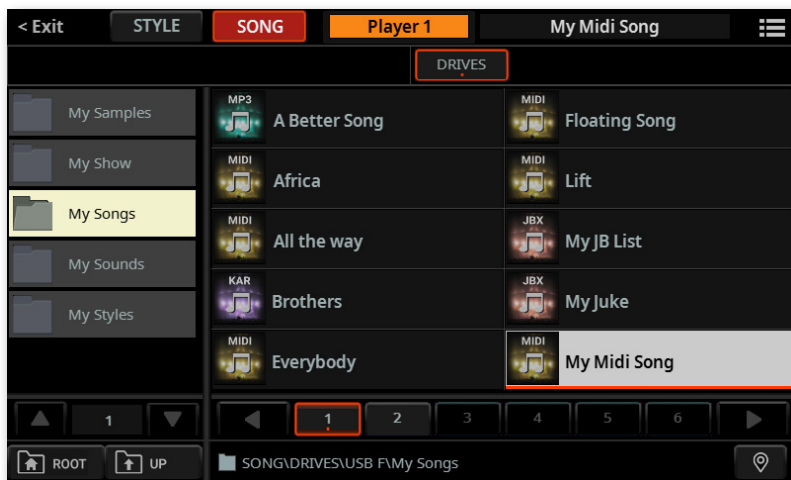

9 If you want to close the **Select** window (and it does not close by itself), press the **EXIT** button.

HINT: When a window does not close by itself, it means the **Display Hold** parameter is turned on. See [Display Hold](#) on page 67.

In the end, you will see the name of the selected Song in the dedicated area of the **Main** page.

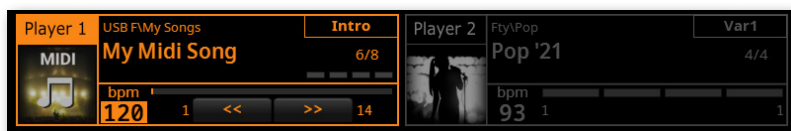

10 If you want, repeat the same procedure to assign a Song (or Style) to the other Player.

Playing the Songs

Starting, stopping and controlling the Songs

You can start a single Song, or mix two Song, or Songs and Styles, with the two Players.

■ Set the right mix

> Move the **X-FADER** slider fully to the left to only listen to Player 1, fully to the right to only listen to Player 2.

The indicator over the corresponding Player section will turn on.

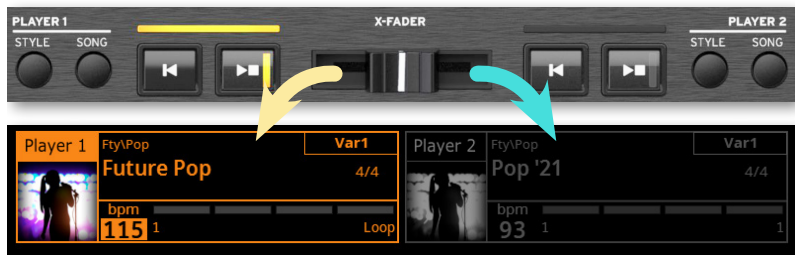

> Move it to an intermediate position to mix the two Players.

■ **Start the Player**

> Press the **PLAY/STOP** (▶◻) button in the section dedicate to the Player you want to start.



While the Song is playing, please note the various indicators in the display.

With a **MIDI Song**:

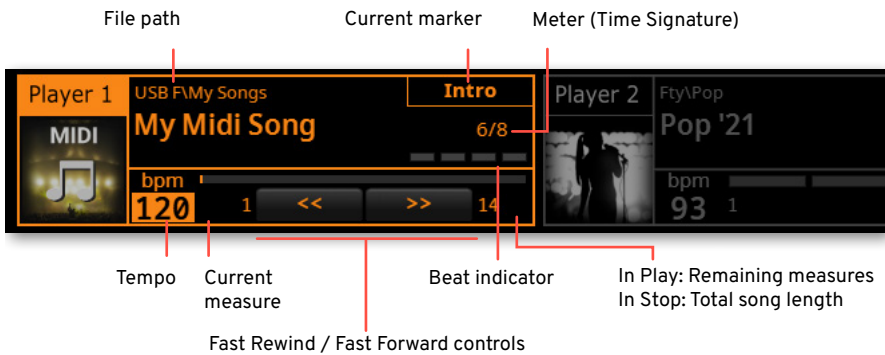

With an **MP3 Song**:

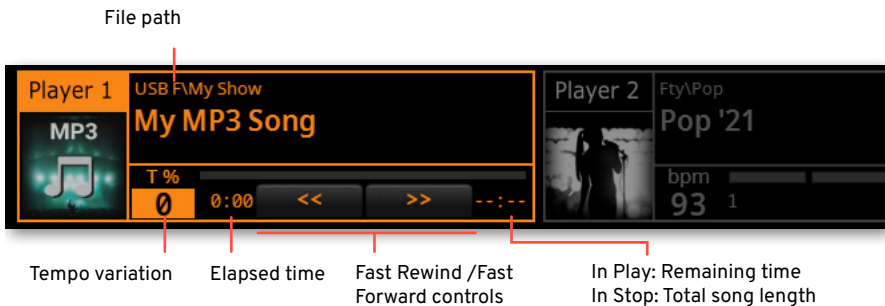

■ Fast Forward the Song

- > Touch the **FAST FORWARD (>>)** button once to jump to the next measure (MIDI Song) or to the next second (MP3 Song).
- > As an alternative, use the **FFW>>** button in the **USER** mode of the **CONTROL** section (on the control panel or the display).

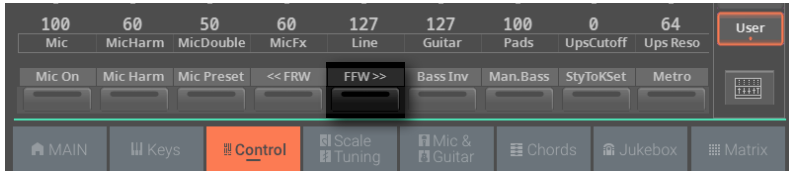

- > Keep touching the **FAST FORWARD (>>)** button to scroll the Song continuously. Release it when you have reached the desired position.

■ Rewind the Song

- > Touch the **FAST REWIND (<<)** button once to jump to the previous measure (MIDI Song) or to the previous second (MP3 Song).
- > As an alternative, use the **<<FRW** button in the **USER** mode of the **CONTROL** section (on the control panel or the display).

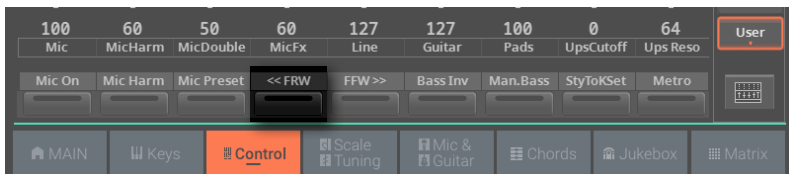

- > Keep touching the **FAST REWIND (<<)** button to scroll the Song continuously. Release it when you have reached the desired position.

■ Pause and resume playback

- > Press the **PLAY/STOP (▷◻)** button to stop the Song at the current position. The button's indicator will become white.
- > Press the **PLAY/STOP (▷◻)** button again to resume playback. The indicator will get the Player's color (orange or blue) again.

■ Stop the Player and return to the beginning of the Song

- > Press the **STOP/GO TO START (⏮)** button to stop the Player and move to the beginning of the Song. The button's indicator will turn off.

■ Start and stop both Players at the same time

You can start both Players at the same time, and mix them with the **X-FADER** while playing.

- > Keep the **SHIFT** button pressed, and press any of the two **PLAY/STOP** (▷□) buttons to start both Players at the same time.
- > Keep the **SHIFT** button pressed, and press any of the two the **PLAY/STOP** (▷□) buttons to stop both Players at the same time.

Fade In/Out

Using the Fade control

You can use the **FADE** button to start and/or stop a Song with a smooth fade-in or out.



■ Fade in

> While the Song is not playing, press the **FADE** button to light up its indicator and start with a smooth fade-in.

The Song will start. When the maximum volume is reached, the indicator will turn off.

■ Fade out

> When the Song is approaching its end, press the **FADE** button to end it with a smooth fade-out.

Setting the Fade time

> Go to the **Settings > Menu > General Controls > Basic** page to set the Fade In and Fade Out time.

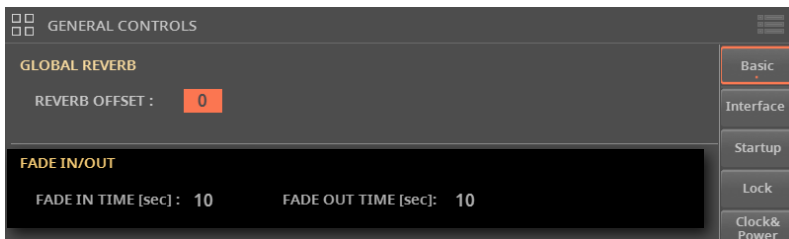

Playing the Keyboard Sounds along with the Song

■ Play along with the Song

- > While the Song is playing, play the keyboard.

■ Choose different Sounds from the Keyboard Set Library

- > Choose a different **Keyboard Set** from the **KEYBOARD SET LIBRARY** section of the control panel, or by touching the **name of the selected Keyboard Set** in the **Main page**.

■ Choose different Sounds from the Style or SongBook Entry

- > The latest Style or SongBook Entry you selected contains up to four Keyboard Sets. Choose a different **Keyboard Set** from the **KEYBOARD SET** section under the **X-FADER**.



- > You can also choose them from the **Keyboard Set** area of the **Main page**.

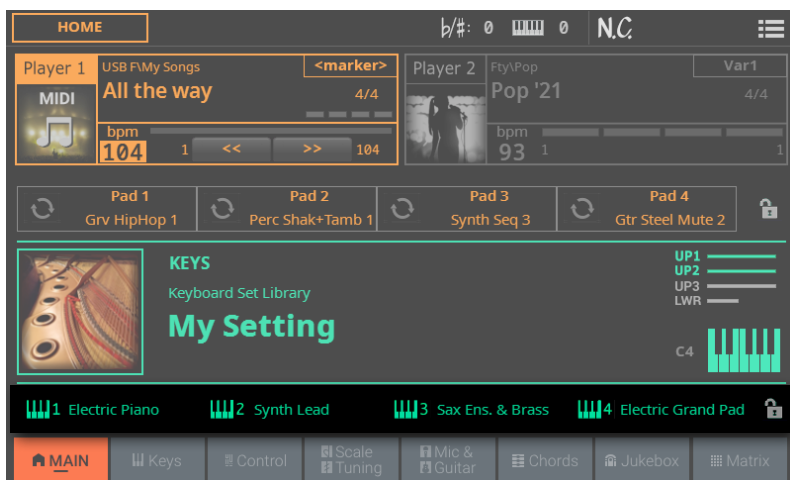

Transpose the Songs to play in an easier key

With Songs in a difficult key, you may want to transpose them to an easier key. You can choose to only apply transposition to the Songs, without transposing the keyboard.

■ Activate transposition only for the Songs

- 1 Go to the **Settings > Menu > Tuning > Transpose Control** page.
- 2 Activate Transpose on the Song, and deactivate it on the Keyboard.

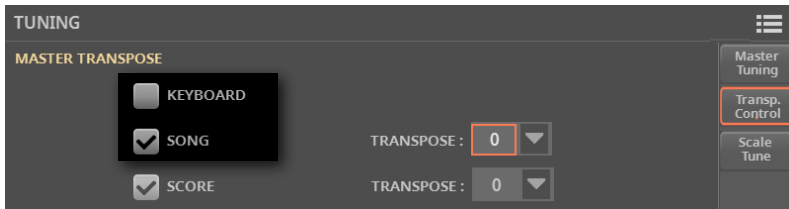

■ Transpose the Songs

- > Use the **TRANPOSE** buttons on the control panel.



Playing a list of songs (Jukebox)

The Jukebox list

The Jukebox list is a list of songs, that you can use as a playlist to quickly select all the songs of your show, or as a random list of songs for the background music.

Creating a Jukebox list from a folder

You can quickly convert all the Songs contained in a folder into a Jukebox list. This is useful to play background music in a random-like way, without having to program a playlist.

■ Select the folder

- 1 Press the **SONG** button on the control panel, or touch the **name of the Style or Song** in the display.
- 2 Be sure you are browsing the Songs, and not the Style. If not, touch the **SONG** button at the top of the window.

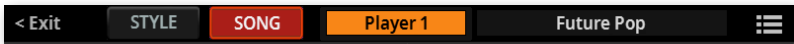

The **Song Select** window will appear.

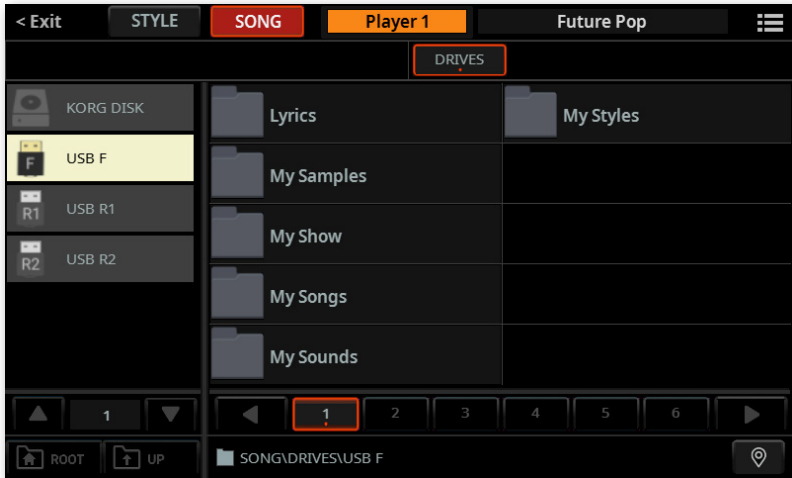

3 Browse through the files and folders, until you find the folder containing the Songs to play, and open it.

■ Make a Jukebox list from the selected folder

1 While the folder containing the Songs is open, choose the **Create Jukebox List** command from the **page menu** (☰).

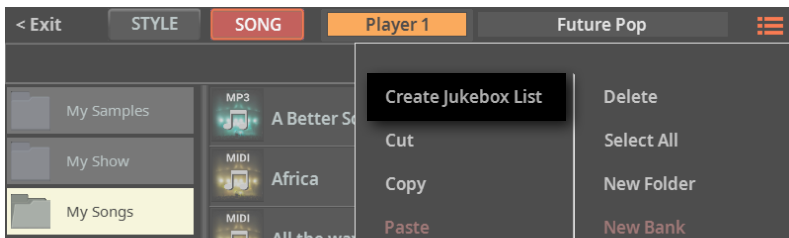

A Jukebox list will be automatically generated and assigned to Player 1. The order in which the Songs will be played back will depend on how they appear in the **Song Select** window.

- Go to the **Home > Jukebox** page to see the newly created list.

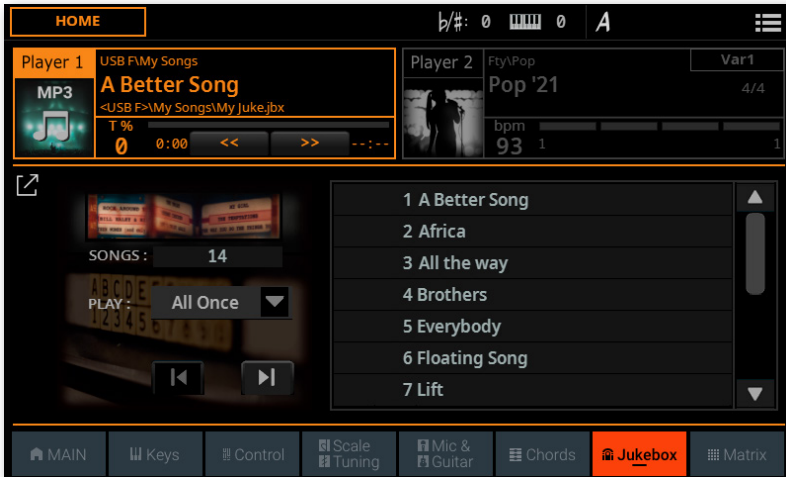

- If you want to save the list, choose the **Save Jukebox List** command from the **page menu** (☰).

■ Play the Jukebox list

You can immediately play the list of Songs from the selected folder.

- Start and stop the Songs by pressing the **PLAY/STOP** (▶◻) button.
- Use the standard **PLAYER 1** controls to play, pause, stop, fast forward and fast rewind the Songs.
- Use all the Jukebox controls, as described below.

Creating a Jukebox list from different folders

You can choose MIDI or MP3 Songs from any folder. This is useful to create a playlist for a show, without having to look around for the individual Songs in their respective folders.

Creating a Jukebox list

- 1 Go to the **Home > Jukebox** page.

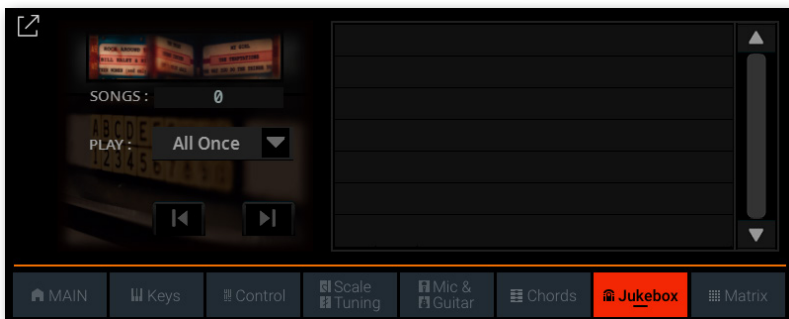

- 2 Touch the **Expand** (↗) button to expand the pane.

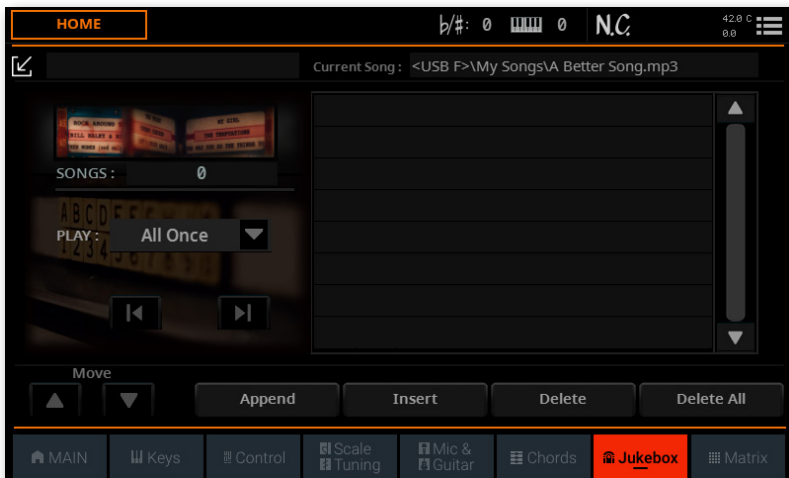

- 3 If a list of Songs already exists (because you selected an existing Jukebox file), and you want to start anew, touch the **Delete All** button to delete all from the list. Otherwise, you can simply edit the existing list.
- 4 Touch the **Append** or **Insert** button to open the **Song Select** window. **Append** will append a Song to the end of the list, while **Insert** will insert a Song between the selected item and the previous one.

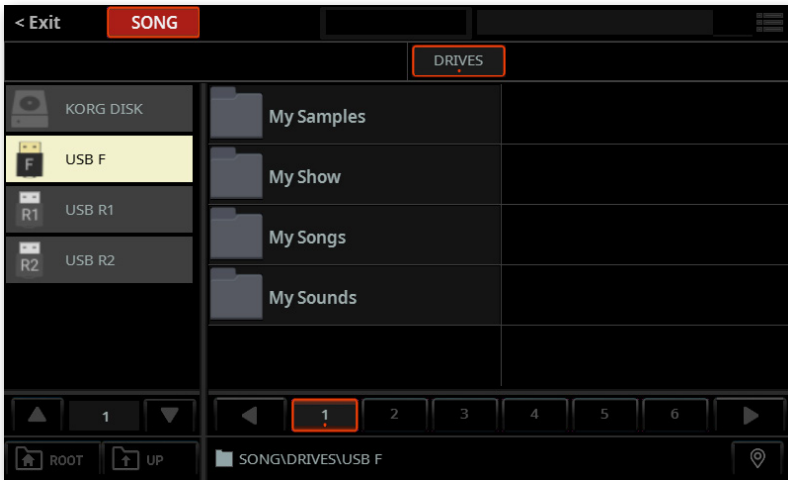

- 5 Select a drive and browse through the folders in the drive. You can choose Songs from any folder.
 - 6 Touch the MID, KAR and MP3 files to be added. If you like, you can choose another Jukebox (JBX) file, and add all its Songs to the Jukebox list you are editing.
- Hint:** Don't worry about the correct order or the Songs in the list. You will be able to rearrange them later.
- 7 When done, press the **EXIT** button to return to the **Jukebox** pane.

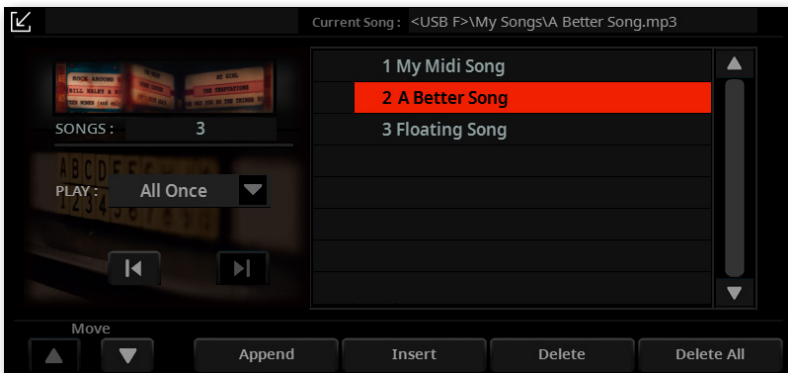

- 8 Repeat the above procedure and continue adding Songs to the list, until you have a full playlist for a show or session.
- 9 In the end, touch the **Collapse** (↙) button to collapse the pane again.

Editing the Jukebox list

■ Rearrange the Songs in the list

If the order of the Songs added to the list is not the desired one, rearrange them.

- 1 Touch the Song to move.
- 2 Use the **Move > Up** (▲) and **Move > Down** (▼) buttons on the display to move the selected Song to a different position in the list.

■ Delete unwanted Songs from the list

- > Touch the **Delete** button to delete the selected Song from the list.
- > Touch the **Delete All** button to delete all Songs from the list.

■ Choose the playback options

- > Use the **Play** pop-up menu to choose the way the list will be played back.

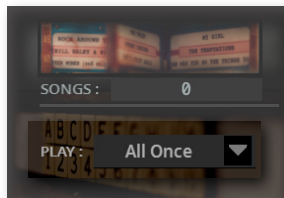

Play mode	Meaning
All Once	All the Songs of the list are played back once, from the first to the last one.
Single	The selected Song is played back, then playback automatically stops. To play the following Song in the list, select it and press the PLAY/STOP button.
All Loop	All the Songs of the list are played back once, and then restart from the beginning, until you press the PLAY/STOP or STOP/GO TO START button.

Saving the Jukebox list

1 While in the **Jukebox** pane, choose the **Save Jukebox List** command from the page menu (☰), to open the **Save Jukebox List** dialog.

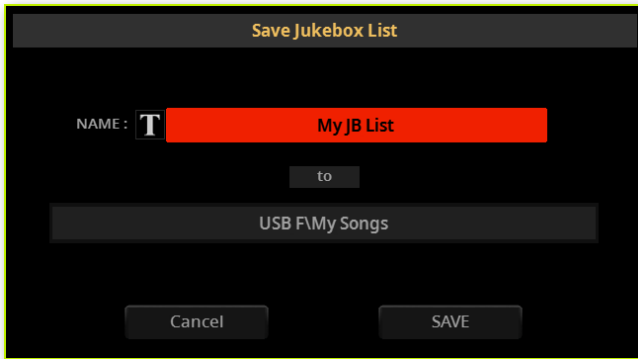

2 While in the **Save Jukebox List** dialog, touch the **Text Edit (T)** button if you want to assign the Jukebox file a new name. Edit the name and confirm to return to the **Save Jukebox List** dialog.

3 Touch the **To (target path)** to open the file selector, and browse through the drives and folders, until you find and open the target folder. Press the **EXIT** button to return to the **Save Jukebox List** dialog.

4 When done, touch the **Save** button to confirm saving the list, or the **Cancel** button to stop the procedure.

Playing back the Jukebox list

Instead of single Songs, you can assign a Jukebox file to Player 1.

Opening a Jukebox list

■ Open the Song Select window from the control panel

> Press the **SONG** button in the **PLAYER 1** section.

■ Open the Song Select window from the display

> Touch the **name of the Song** in the display.

■ Select the Jukebox file

> Browse through the files, until you find the Jukebox (.jbx) file, and open it.

You can quickly locate the Jukebox files by their icon.



The selected Jukebox list contains pointers to Songs residing in various drives and folders. Please do not move nor delete the Songs, nor disconnect any connected USB storage device containing the Songs.

Playing the Jukebox list

■ Start the Jukebox list

1 While in the **Home > Main** page, touch the **Jukebox** tab to see the list of Songs contained inside the selected Jukebox list.

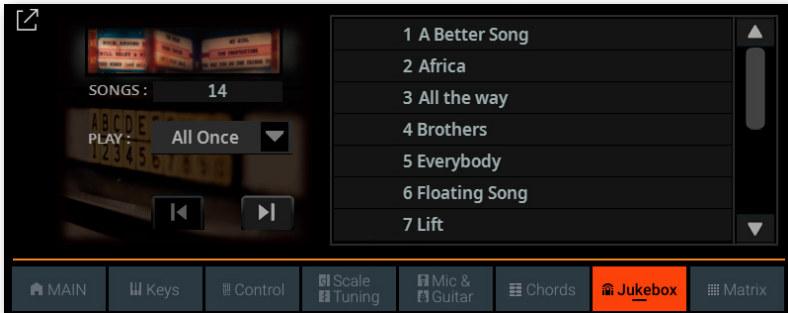

2 Touch the **name of the Song** you want to start from.

3 Start and stop the Songs by pressing the **PLAY/STOP** (▶◻) button.

By default (with one of the All play options selected next to the list), all the Songs in the list will continue playing one after the other, until you don't stop them.

4 Use the standard **PLAYER 1** controls to play, pause, stop, fast forward and rewind the Songs.

■ Move through the Songs

There are various ways to move through the Songs.

- > Touch in the list the Song you want to play.
- > Jump to the next Song in the list by touching the **Next Song** button in the **Jukebox** pane.

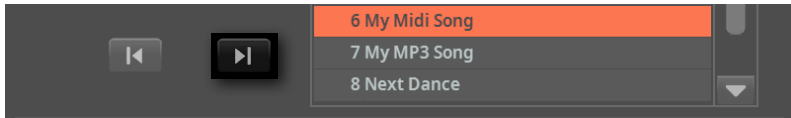

- > Jump to the previous Song by touching the **Previous Song** button in the **Jukebox** pane.

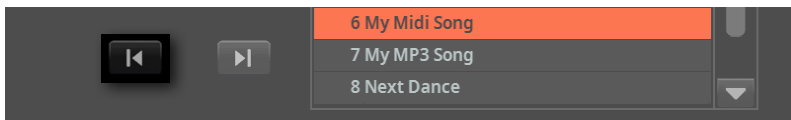

- > Press the **STOP/GO TO START** (**[K]**) button to go back to the beginning of the current Song.

The special tracks (Melody, Drum & Bass)

Muting the melody or singer's voice

You can mute the melody of the MIDI Song, or remove the singer's voice from an MP3 Song, if you are going to play or sing live. This will avoid overlapping your playing or singing with the internal Sounds or the voice recorded in the MP3 Song.

Please note that programming an assignable switch will tie this function to a particular Keyboard Set or SongBook Entry. On the contrary, programming a Control button or a footswitch will offer a global option, that will not change when choosing a different Keyboard Set or SongBook Entry.

Selecting a MIDI Song's Melody track

One of the sixteen tracks of the MIDI Songs has to be chosen as the Melody track. While there isn't an official standard, it is common practice to use Track #4 as the Melody track.

- 1 Go to **Settings > Menu > Preferences > Song** page.
- 2 Use the **SMF Melody Track** parameter to choose a track number.

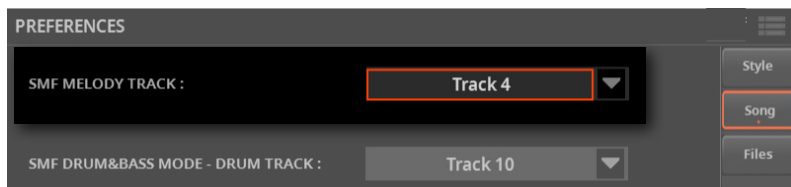

- 3 You can activate this function by pressing **BUTTON #8** in the **CONTROL** section, when in **MAIN** mode. See below how to assign the **Melody/Voice Remover** command to an assignable switch or footswitch.

Playing Drum & Bass

You can define two MIDI Song's tracks as the Drum and Bass tracks. These tracks will play when selecting the **Drum&Bass** function, that you can assign to a switch, Control button or footswitch.

Please note that programming an assignable switch will tie this function to a particular Keyboard Set or SongBook Entry. On the contrary, programming a Control button or a footswitch will offer a global option, that will not change when choosing a different Keyboard Set or SongBook Entry.

Selecting a MIDI Song's Melody track

Two of the sixteen tracks of the MIDI Songs have to be chosen as the Drum and Bass tracks. It is common practice to use Track #2 as the Bass track and Track #10 as the Drum track in the Songs. Please note that the Bass track is usually Track #9 in the Styles.

- 1 Go to **Settings > Menu > Preferences > Song** page.
- 2 Use the **SMF Drum&Bass Mode - Drum/Bass Track** parameters to choose the track numbers.

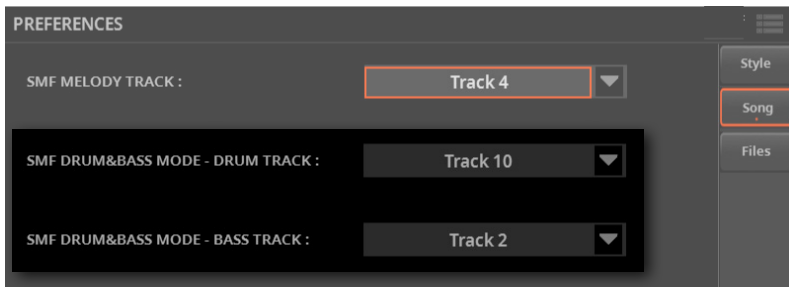

- 3 You can activate this function by pressing **BUTTON #7** in the **CONTROL** section, when in **MAIN** mode. See below how to assign the **Drum&Bass Mode** command to an assignable switch or footswitch.

Programming the switches for the special tracks

Programming an assignable switch

You can assign the **Melody/Voice Remover** and/or **Drum&Bass Mode** functions to an assignable switch.

- 1 Go to the **Home > Menu > Switches** page. As an alternative, keep the **SHIFT** button pressed, and press the **ASSIGNABLE SWITCH** you want to program.
- 2 Assign the **Melody/Voice Remover** function to one of the **Switch** parameters.

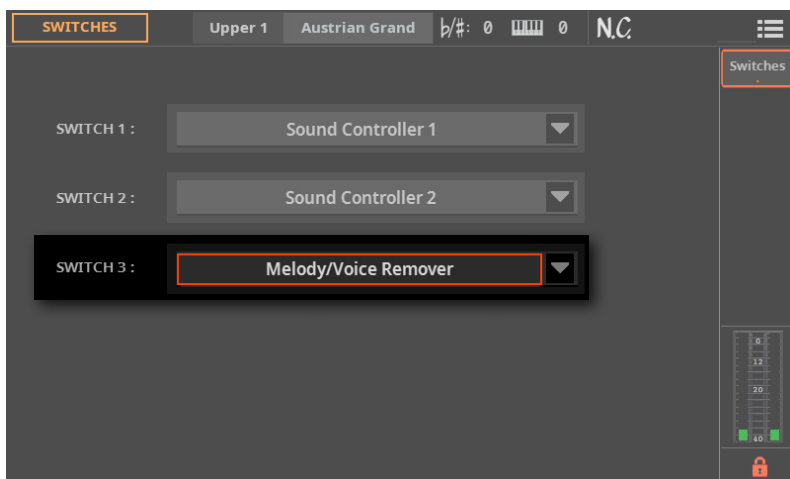

- 3 If you want this assignable switch to remain programmed in the same way, even if you select a different Keyboard Set or SongBook Entry, lock this page.



- 4 If you want this as the setup at startup, keep the **MY SETTING** button pressed for about one second, and touch OK to confirm saving the **My Setting** Keyboard Set.

Programming a footswitch

You can assign the **Melody/Voice Remover** and/or **Drum&Bass Mode** functions to a footswitch.

- 1 Go to the **Settings > Menu > Controllers > Foot** page.
- 2 Assign the **Melody/Voice Remover** function to the **Pedal/Footswitch** parameters corresponding to the footswitch connected to the instrument.

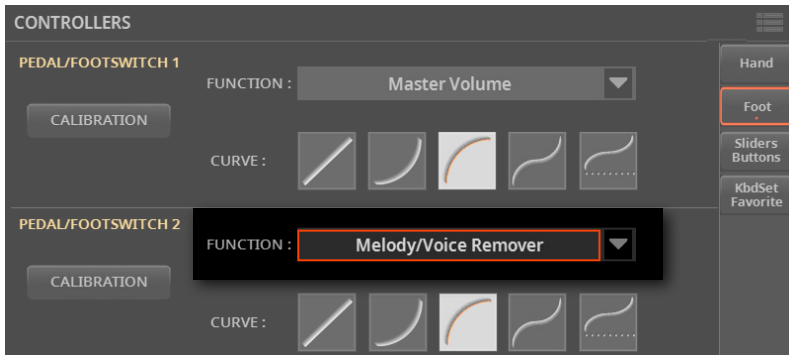

The changes will be automatically saved to the global settings.

Using the switch or footswitch to mute the melody or singer's voice

- 1 While an Song is playing, press the programmed assignable switch or footswitch to remove the melody or singer's voice.
- 2 Press the **same switch** or footswitch again to let the melody or singer's voice reappear.

10

**Lyrics,
Chords,
Markers,
Score**

Lyrics and chords

Choosing one of the Players

- > While in the **Lyrics, Score** or **Markers** page, you can touch either the **Player 1** or **Player 2** button in the title bar to select the corresponding Player.
- > During playback, move the **X-FADER** slider to mix the two Players.
- > Move the **X-FADER** slider fully to the left to only listen to Player 1, fully to the right to only listen to Player 2. Move it to the center to balance the two Players.

The indicator over the corresponding Player section will turn on.

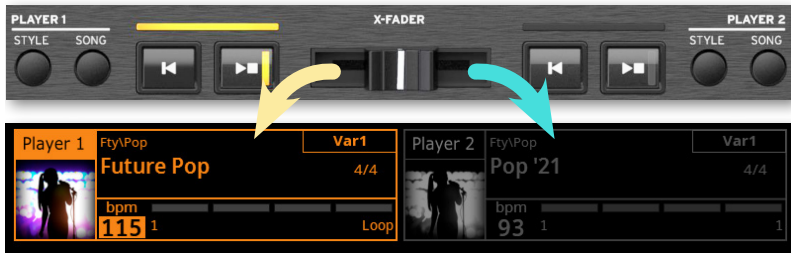

Where are lyrics and chords contained?

- > **Inside the MIDI Songs.** Lyrics and chords may be contained inside MIDI Songs as MIDI events.
- > **Inside the MP3 Songs.** Lyrics may be contained into MP3 Songs as **ID3/Lyrics3** and **ID3/Frames** tags.
- > **In TXT files associated to Styles or Songs.** Lyrics and chords may be contained in a TXT file having the same name of a Style, a MIDI or MP3 Song, and residing in the same folder. You can also load a text file while playing a Style or a Song.
- > **In TXT files linked to SongBook Entries.** A TXT file can be linked to a SongBook Entry.

Reading the lyrics and chords contained in a Song

Lyrics and chords may be contained in a MIDI Songs as Lyrics MIDI events. This is the best way to use them, since synchronization with the Song is automatic.

Reading lyrics and chords

■ Open the Lyrics page

> Press the **LYRICS** button on the control panel. The **Lyrics** page will appear, and you will see the lyrics assigned to the selected Player.

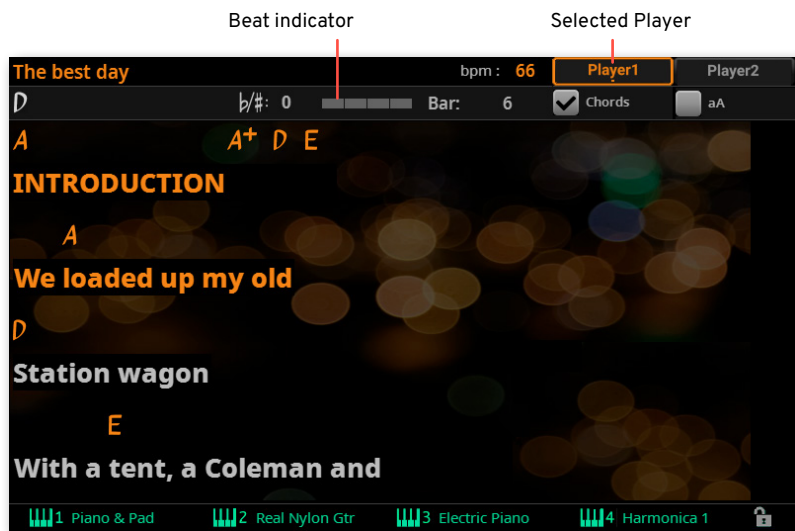

Keyboard Sets (from the latest Style or SongBook Entry)

■ Read the lyrics

- > While the Song is playing, lyrics contained in a MIDI or MP3 Song will automatically scroll in the display, in time with the music. Lyrics at the current position will be highlighted.

■ Exit from the Lyrics page

- > When done with the lyrics, press either the **LYRICS** or the **EXIT** button.

Changing the text size

You can switch between two text sizes. Use the **aA** checkbox in the **Lyrics** page to change the font size.

- > Select the **aA** checkbox to choose a smaller font and see more text in one page.

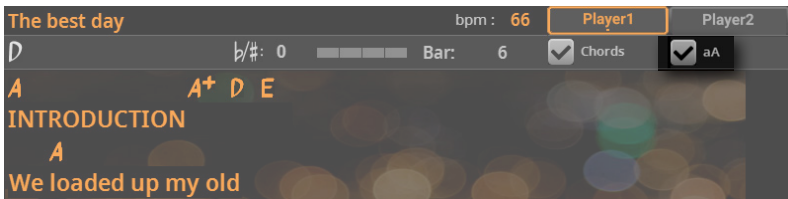

- > Deselect the **aA** checkbox to choose a bigger font, and make the lyrics more readable at a distance.

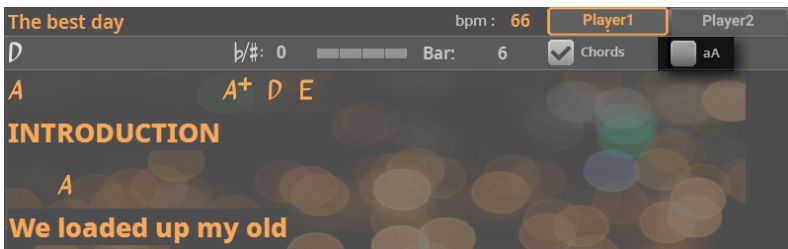

Showing/hiding chords

You can show or hide the chord symbols that might be included as Lyrics events in the MIDI Songs. Use the **Chord** checkbox in the **Lyrics** page.

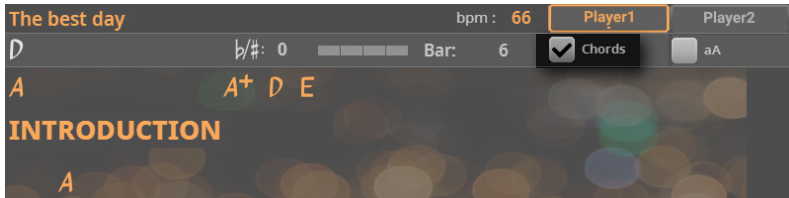

- > Select the **Chord** checkbox to see the chord symbols. Chord symbols (if any) will appear above the lyrics, in time with the music.
- > Deselect the **Chord** checkbox to hide the chord symbols.

Chord transposition

When using the **TRANPOSE** buttons, chord symbols may also be transposed, depending on the Master Transpose settings. To let the chord symbols be transposed, go to the **Settings > Menu > Tuning > Transpose Control** page, and be sure one of the following settings is selected.

■ Chord symbols transposed with the Songs

- > Select both the **Song** and **Score** checkboxes.

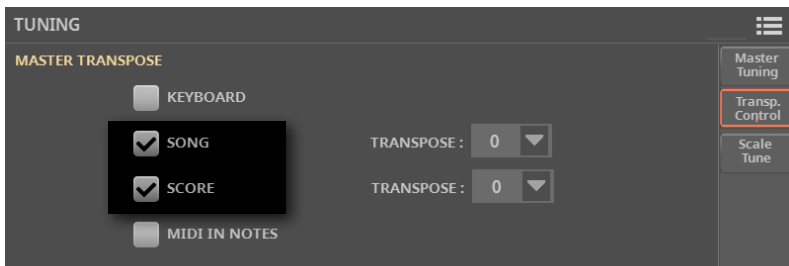

■ Songs transposed, but not the Chord symbols

- 1 Select the **Song** checkbox. Leave the **Score** checkbox not selected.

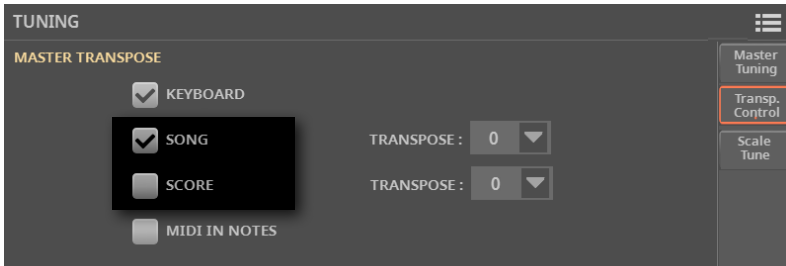

For more information about transposing the chord symbols, see [Transposing the score and the chord symbols](#) on page 449.

Reading the lyrics and chords loaded as a text file

Lyrics and chords may be loaded as a text (TXT) file, either as a file having the same name of the Style or Song, linked from a SongBook Entry, or by loading it on-the-fly. They will have to be scrolled by using manual controls on the display, with a switch or a footswitch.

See [Creating text files on a personal computer](#) on page 238 for more information on how to create correctly formatted text files.

Loading a text file with the same name of the Song

Lyrics and chords may be contained in a TXT file having the same name of a Style, a MIDI or MP3 Song. For example, if a 'MySong.txt' file exists in the same folder as the 'MySong.mid' file or 'MySong.mp3' file, loading this latter will load the TXT Lyrics file as well.

We recommend not to copy text files into a KST folder. If you want to add a text file to a Style, please copy the Style to an ordinary folder into one of the drives, together with the associated text style.

Please note that this text will prevail over any Lyrics event contained in the MIDI Song.

Linking text files to SongBook Entries

Lyrics and chords may be contained in a text (TXT) file linked from a SongBook Entry. The Entry may be either Style- or Song-based. See the chapter dedicated to editing a SongBook Entry.

On-the-fly loading of Lyrics and chords from an external text file

When no lyrics or chords are contained or associated to the Style or Song, you can load a text (TXT) file after having chosen a Style or Song.

■ Load a TXT file on-the-fly

An empty **Lyrics** page with a message will appear when you press the **LYRICS** button in one of the following cases:

- The Song does not contain lyrics and chords.
- No external text file is associated to the Style or the Song.
- No text file is linked from a SongBook Entry.

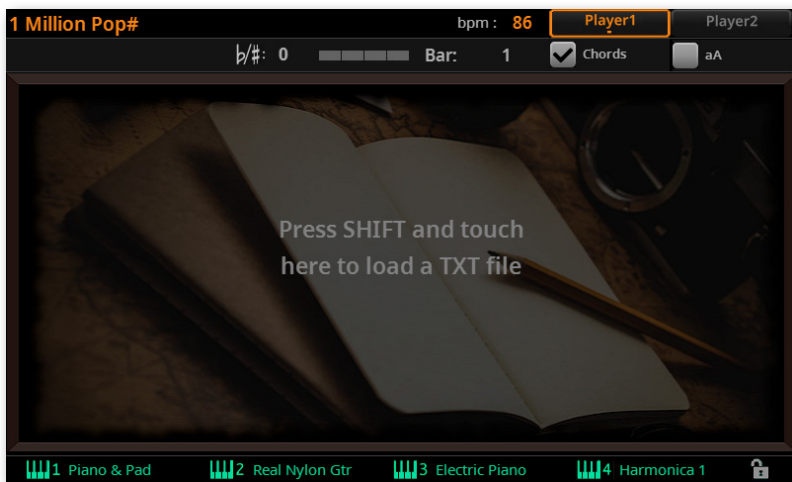

In this case, do the following:

- 1 Keep the **SHIFT** button pressed and touch the **center of the display**.
- 2 The **Select** window will appear, and will let you choose a TXT file to be loaded.
- 3 With a TXT file selected, choose the **Load** command from the **page menu** (☰) to load it.
- 4 Press the **EXIT** button to return to the **Lyrics** page.

Manually scrolling the text

If the text has been linked or loaded as a text (TXT) file, it will not scroll automatically while the Song is playing back. You can manually scroll it in one of the following ways.

■ Scroll the text on the display

- > Scroll the text by using the **DIAL** or **UP/DOWN** controls or the **vertical scrollbar**.

■ Scroll the text with a switch, footswitch or Control button

1 Assign the **Text Page Down** command to a physical controller. If you want, you can also assign the **Text Page Up** command to a different controller, to move the text back.

- > If you want to assign it to an assignable switch, go to the **Home > Menu > Switches > Switches** page.
- > If you want to assign it to a footswitch, go to the **Settings > Menu > Controllers > Foot** page.
- > If you want to assign it to a Control button, go to the **Settings > Menu > Controllers > Sliders/Buttons** page.

2 Return to the **Lyrics** page, and scroll the text by using the programmed physical controller.

Please note that programming an assignable switch will tie the page scroll command to a particular Keyboard Set or SongBook Entry, dedicated to a particular Song based on an external text file. On the contrary, programming the footswitch or Control button will offer a global option, that will not change when choosing a different Keyboard Set or SongBook Entry.

Creating text files on a personal computer

Choosing the correct text file format

By using the Unicode text encoding, Pa5X can support lyrics in several languages. The file must be a plain/normal text file, with Unicode UTF-8 (with BOM) encoding, and Windows-compliant end of line (CRLF).

To create a TXT file with the correct encoding, you can use a Windows PC or Mac with an advanced text editor. Two excellent applications you may use are Don Ho's [Notepad++](#) for Windows and Bare Bone's [BBEdit](#) for Mac.

Language Text Encoding

When creating or editing a text file, we suggest you use the **UTF-8 with BOM** encoding. If this is not possible, please choose one of the following text encodings when saving the file, being sure it is matching the language selected in Pa5X. Choosing a codeset for your text file is always recommended, being an added safety.

Language	Encoding (Notepad++)	Encoding (BBEdit)
Dutch	Western European > Windows-1252	Western (Windows Latin 1)
English	Western European > Windows-1252	Western (Windows Latin 1)
Estonian	Baltic > Windows-1257	Baltic (Windows)
French	Western European > Windows-1252	Western (Windows Latin 1)
German	Western European > Windows-1252	Western (Windows Latin 1)
Greek	Greek > Windows-1253	Greek (Windows)
Italian	Western European > Windows-1252	Western (Windows Latin 1)
Polish	Central European > Windows-1250	Central European (Windows Latin 2)
Russian	Cyrillic > Windows-1251	Cyrillic (Windows)
Spanish	Western European > Windows-1252	Western (Windows Latin 1)
Turkish	Turkish > Windows-1254	Turkish (Windows Latin 5)

Setting the language on Pa5X

To correctly read text on your Pa5X, be sure to set the **Language** parameter to your language.

- 1 Go to the **Settings > Menu > General Controls > Interface** page.
- 2 Use the **Language** pop-up menu to select one of the available languages.

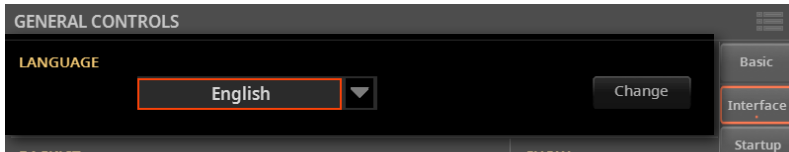

- 3 Touch the **Change** button to apply the selected language.

Please note that with text files encoded in ASCII (instead of Unicode), mismatches between the instrument's selected language and the text file language may happen. In this case, we suggest to resave the text file with the correct encoding from a personal computer. As a (not recommended) alternative, you can change the instrument's language, and reload the text file.

Editing the TXT file on a Windows PC

- 1 Launch Notepad++.
- 2 Open the original TXT file.
- 3 Choose **File > New** to open a new tabbed window containing the new TXT file.
- 4 Choose **Encoding > Character sets > [Your Language] > [Encoding]**.

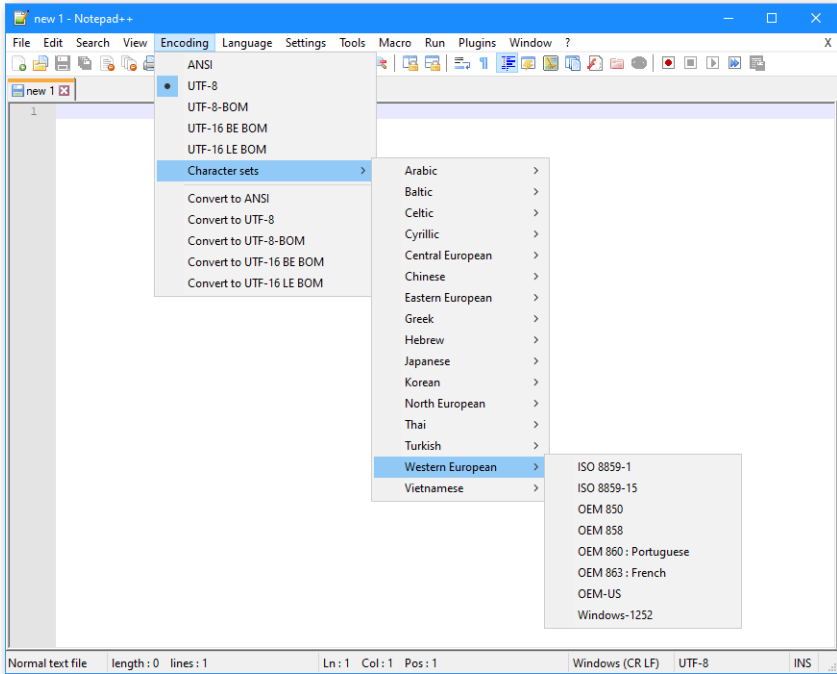

- 5 Click on the tab containing the original TXT file.
- 6 Select all and copy the selected text.
- 7 Click on the tab containing the new TXT file.
- 8 Paste the copied text.
- 9 Save and assign a name to the new TXT file.
- 10 Load the file into your instrument, and check it.

Editing the TXT file on a Mac

- 1 Launch BBEdit.
- 2 Open the original TXT file.
- 3 In the status bar (in the lower part of the window) find the **Document Text Encoding** parameter (it usually defaults to **Unicode UTF-8**). Click it to open the popup menu, and choose **Unicode (UTF-8, with BOM)**.

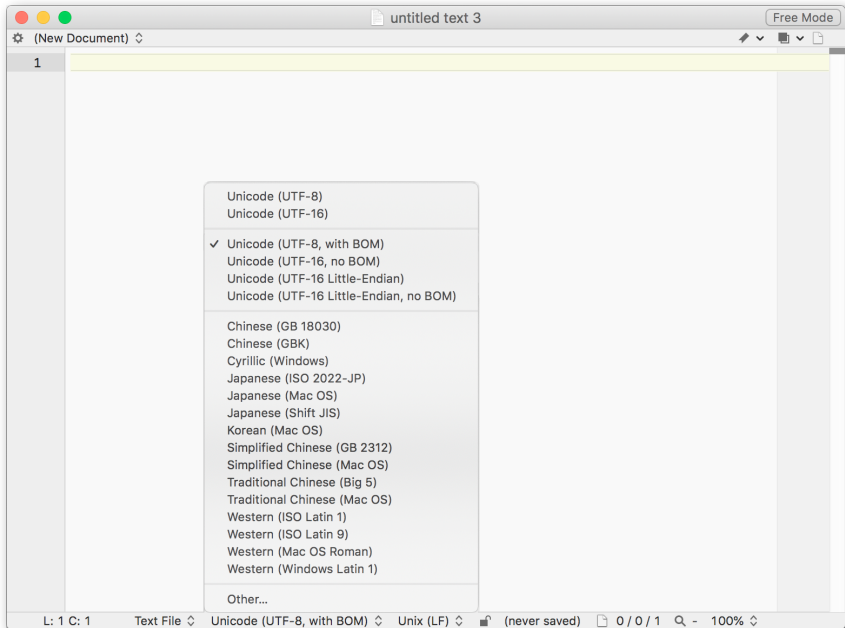

- 4 Next to it in the status bar, find the **Line Break Type** parameter, usually defaulting to **Unix (LF)**. Click it to open the popup menu, and choose **Windows (CRLF)**.



- 5 Save a copy of the file by choosing **File > Save As**. Give the new file a name, and be sure that the **Save As** dialog box shows the correct Line breaks and Encoding.
- 6 Load the file into your instrument, and check it.

Formatting text for the Pa-Series instruments

While in a text editor, text files must be formatted with non-proportional fonts (like Courier, Courier New, Letter Gothic, Lucida Sans, Menlo, Monaco, Vera Sans, or any other monospaced font). Up to 41 characters can fit a single line of text when using the smaller font size in the Pa, 24 when using the bigger font size.

- Small font in a text editor and the Pa:

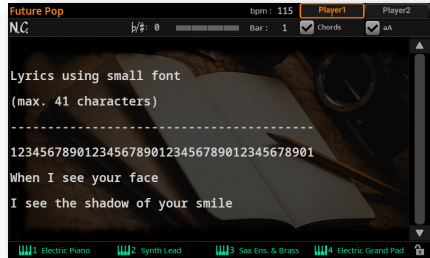
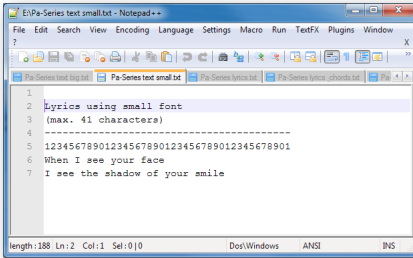

- Big font in a text editor and the Pa:

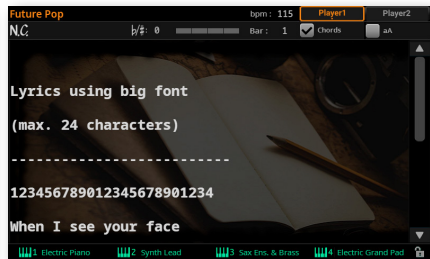
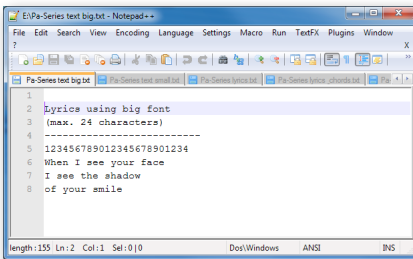

Using imported text as a memo

Importing text files may be useful not only to load Lyrics, but also to load notes on the show. Please find below an example of playlist and gig outline.

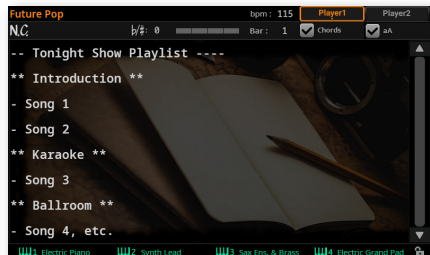
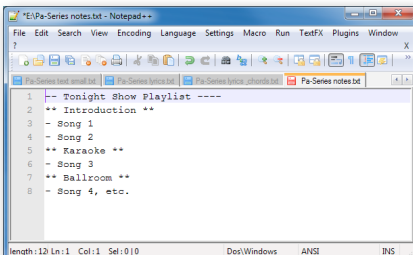

The Markers

Choosing the Markers from the display

The Markers allow for jumping to a saved point in a MIDI Song. Song Marker events contained in a MIDI Song can be read by Pa5X. You can also create your own Markers.

You can select the Markers from the **STYLE ELEMENT / MARKER** buttons in the lower-left area of the control panel, or from the **Markers** page on the display.

NOTE: From now on, the **STYLE ELEMENT / MARKER** buttons will only be called **MARKER**.

- > The **MARKER** buttons on the control panel let you quickly access the Markers of the current Player. You can still access the Markers while, for example, reading the Lyrics on the display.
- > The **Markers** page allows to select the Markers for the current Player, but also allow for pre-selecting Markers or Style Elements in the other Player while not yet selected. If a Style is assigned to the other Player, you will be able to pre-select the Style Elements instead.

■ Access the Markers page

- 1 Assign a MIDI Song to one or both Players.
- 2 Press the **MARKER** button on the right of the display to open the **Markers** window.

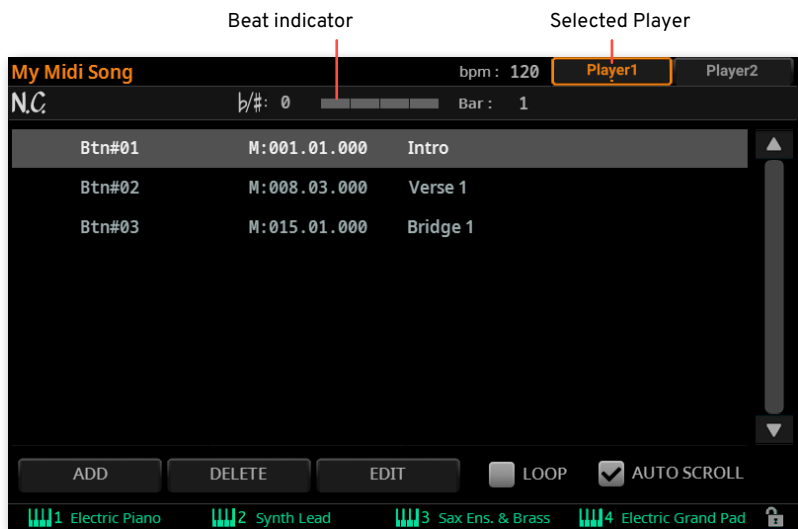

Keyboard Sets (from the latest Style or SongBook Entry)

When accessing this page, the current Player appears selected on top of the page. If it is playing, you can see it progressing in the **beat indicator**.

Each of the Markers in the list corresponds to one of the **MARKER** buttons on the control panel.

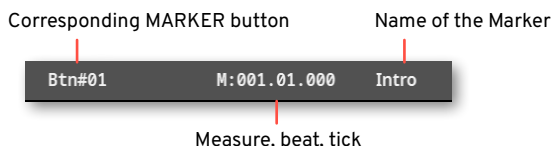

■ Make the markers list scroll automatically

Select the **Auto Scroll** checkbox, to let the markers list scroll automatically during playback, and always let the current marker be shown in the display.

If this checkbox is not selected, the list will not scroll with the Song.

■ Select a Marker in the current Player

> While the Markers of the **current Player** appear in the display, touch one of them to select it. At the beginning of the next measure, the Song will jump to the saved position.

■ Pre-select a Marker in the other Player

1 Touch the button corresponding to the **other Player** on top of the page.

If the other Player has a Style assigned, the corresponding page will show the Style Elements instead of the Markers.

When switching to the other Player, the **beat indicator** will show the activity of the newly selected Player. If it is in stop, there will be no activity shown.

2 Choose one of the **Markers** from the other Player to pre-select it.

3 When moving the **X-FADER** to select the other Player, you will find the selected Marker ready to play.

4 If the newly selected Player is stopped, press the corresponding **PLAY/STOP** (▷□) button to start it.

You can see the activity of the selected Player in the **beat indicator**.

5 If you want, press the **PLAY/STOP** (▷□) button corresponding to the other Player to stop it.

Choosing the Markers from the control panel

You can use the **buttons** in the **MARKER** section on the control panel to choose the Markers. The **lower indicator** on the left of the buttons will show that the Markers can be selected.

The buttons corresponding to the Markers are shown in the **Markers** page.

You can access the first 15 Markers from the **MARKER** buttons. Any additional Marker has to be selected from the display.

1 Be sure the **lower indicator** of the **MARKER** section is turned on, showing you can select the Markers.



2 If a button indicator is white, it means that it corresponds to a Marker. If it is dark, no Marker is associated with that button.



3 Press **one of the buttons** in the **MARKER** section on the control panel to jump to the corresponding Marker.

At the beginning of the next measure, the Song will jump to the saved position. The button indicator will become orange (Player 1) or blue (Player 2) depending on the selected Player.

Creating and editing markers

You can add your own Markers to a MIDI Song, then save them into the MIDI Song.

■ Open the Markers page

> While a MIDI Song is assigned to the current Player, press the **MARKER** button on the right of the display. If there are no Markers in the Song, you will see an empty list.



■ Add Markers

1 Start the Player by pressing the **PLAY/STOP** (▷◻) button.

Markers can be added even while the Player is not running, but adding them while the Song is running is easier.

2 When you reach the position you want to save as a Marker, touch the **Add** button.

> If you touch **Add** within the **early beats** of the measure, the beginning of the current measure is saved as a Marker.

> If you touch **Add** within the **last beat** of the measure, the beginning of the following measure is saved as a Marker.

- Do the same for any of the following Markers.

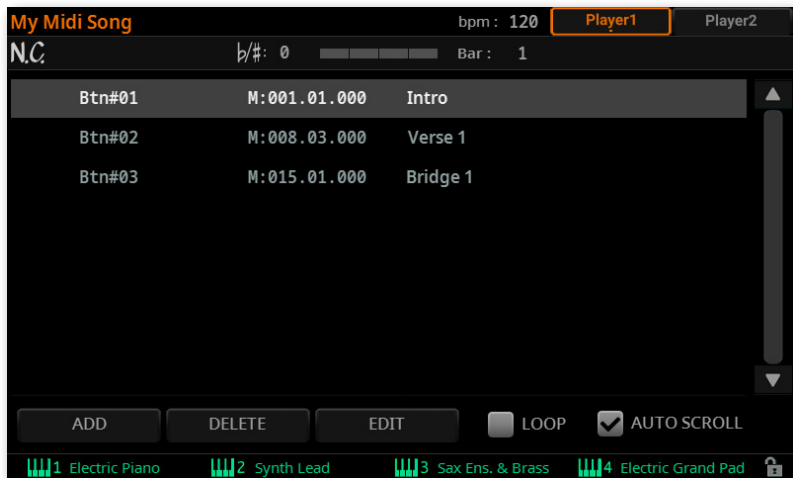

- Stop the Player by pressing the **PLAY/STOP** (▶◻) button.

■ Delete Markers

- Touch the Marker to be deleted in the Markers list.
- Touch the **Delete** button to delete the selected Marker.
- Save the Markers (as described below).

■ Edit the name and position of a Marker

- Touch the Marker to be edited in the markers list.
- Touch the **Edit** button to start editing the marker. The **Edit Marker** window will appear.

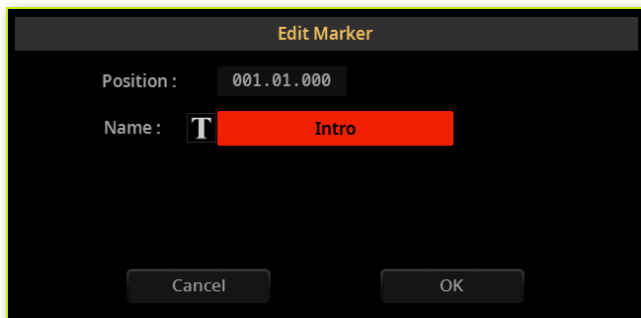

- 3 While in the **Edit Marker** window, edit the position and name of the selected Marker.
- 4 Touch the **OK** button to save the Marker.

■ Save the Markers in the MIDI Song

- 1 Press the **EXIT** button to exit from the **Markers** page.
- 2 Choose the **Save Song** command from the **page menu** () to save the Markers in the MIDI Song.

Looping a Song section

You can use the Markers to repeat a passage you need practicing.

- 1 Start the Player.
- 2 When you reach the **beginning** of the point you need practicing, touch the **Add** button to create a first Marker.

Usually, you will create the marker one or two measures before the actual starting point.

- 3 When you reach the **end** of the point you need practicing, touch the **Add** button to create a second Marker.
- 4 Select the first Marker, then select the **Loop** checkbox to repeat (loop) between the first and second marker.
- 5 If you no longer need them, delete the Markers. In any case, they will be automatically removed when choosing a different Song or turning off the instrument, if you don't save the Song.

The Score

Reading the music score

With MIDI Songs, you can have a music score of one of the tracks. This will let you read the score on the display or an external monitor (if connected).

Intelligent display of the score

Score generation is smart enough to ‘clean-up’ a track with automatic quantization, syncopation, key and clef generation. Even non-quantized tracks will be shown in a very readable way.

Displaying the music score

■ Show the music score

- 1 Choose a **MIDI Song** to play with the selected Player.
- 2 Press the **SCORE** button to open the **Score** page. A score of the selected track will be generated.

Depending on the content of the track, notes, chords and lyrics are shown in the staff.

The screenshot shows the music score interface for a song titled "Floating Song". The interface includes the following elements:

- Song name:** Floating Song
- Tempo:** bpm: 120
- Selected Player:** Player1 (highlighted in orange)
- Chord symbols:** E/F# (circled in red), G#m7, A, C#m7, D#m7, G#m, G#m7/F#, A/E
- Lyrics:** PERS OF SOME QUIET CONVERSA TION, I HEAR THE DRUMS ECHO IN THE NIGHT, SHE HEARS ONLY WHIS
- Staff:** Two musical staves are shown. The first staff starts at measure 15, and the second staff starts at measure 13. A red circle highlights the current staff (the second one).
- Current position:** A red circle highlights the current position on the second staff.
- Clef:** Treble
- Selected track:** Trk 4 (highlighted in orange)
- Lyrics:** A red line connects the lyrics to the corresponding notes on the staff.
- Controls:** Checkboxes for Lyrics (checked), Chords (checked), and Notes (unchecked). A "M" button with a green light and an "S" button are also visible.

■ Choose a track

- > Choose a track to be seen as music score by using the **Trk** pop-up menu.

Usually (but not always), the Melody is Track #4.

■ Choose the clef

- > Choose a different clef by using the **Clef** pop-up menu.

Usually, the correct clef is automatically assigned by the score generator.

Clef	Meaning
Treble	Standard Treble clef.
Treble+8	Treble clef with transposition one octave upper.
Treble-8	Treble clef with transposition one octave lower.
Bass	Standard Bass clef.
Bass-8	Bass clef with transposition one octave lower.

■ Exit from the Score page

- > When done with the score, press either the **SCORE** or the **EXIT** button.

Following the Song

You can always see where you are in the score by watching at these indicators:

- > A red vertical line on the left side of the score, showing indicating the current staff in play.
- > A red up-pointing triangle, showing the current position.

Showing lyrics, chords, note names

■ Read the Lyrics

- > Touch the **Lyrics** button to make the lyrics (if available) appear or disappear.

■ Read the chords

- > Touch the **Chord** button to make the chord symbols (if available) appear or disappear.

■ Read the note names

- > Touch the **Note** button to make the note name appear or disappear next to each note.

Muting or soloing the selected track

Mute a track if you are going to play or sing it live. This will avoid overlapping between your playing or singing and the internal Sounds.

Solo it if you want to listen to it in isolation.

- > Touch the **Mute (M)** button to listen or mute the selected track.
- > Touch the **Solo (S)** button to listen the selected track alone or together with the others.



You can save the Mute status by saving the MIDI Song.

You can also keep the selected track muted for all the subsequent Songs, by activating the **Song Track Play/Mute** lock in the **Settings > Menu > General Controls > Lock** page.

Music score and transposition

When using the **TRANPOSE** buttons, the music score and chord symbols in the **Score** page may be transposed in various ways. To decide if and how they are transposed, go to the **Settings > Menu > Tuning > Transpose Control** page, and be sure one of the following settings is selected.

■ Transpose the score with the Songs

- > Select the **Song** and **Score** checkboxes.

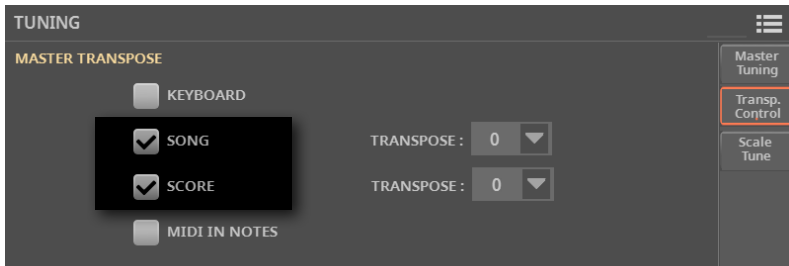

■ Transpose the score, but not the Songs

- > Select the **Score** checkbox, and deselect the **Song** one.

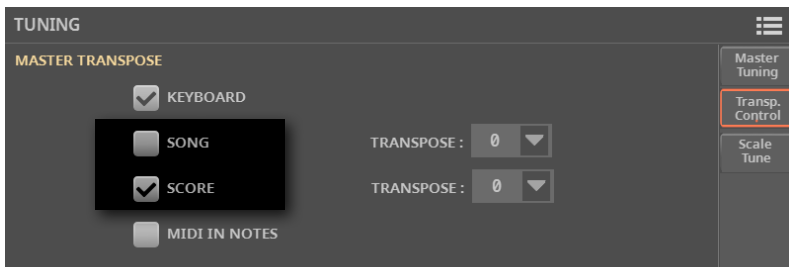

For more information about transposing the score and chord symbols, see [Transposing the score and the chord symbols](#) on page 449.

11

The SongBook

Using the SongBook

What is the SongBook?

The basic idea behind the SongBook is that you always start from a song. By choosing an Entry from the SongBook, you choose a template for that song. Everything you need (Style, Song, Sounds, Mic and Guitar effects, Lyrics, Key, Tempo value) is there at the touch of a single button.

In other words, the SongBook is the onboard music database, allowing you to organize, sort and filter the Styles and Songs for easy retrieving. Each Entry of this database (a 'song') may include information like the artist, title, genre, number, key, tempo, and meter (time signature) of a specified song.

When choosing one of the Entries, the associated Style, MIDI or MP3 Song is automatically recalled. The Master Transpose value is automatically set. The Mic and Guitar Presets might also be recalled. Pads and a Chord Sequence are there.

You can add your own Entries to the SongBook, as well as edit the existing ones. KORGE already supplies some hundred Entries as standard. You can assign four Keyboard Sets, four Pads and a Chord Sequence to each Entry. You can replace Sounds and Effects. You can choose an alternative Tempo, to get a different version of the same Style without having to duplicate it.

Also, you can link a TXT file to any Entry, to be used as the Lyrics of a song, even if there are no Lyrics inside the linked MID or MP3 file, or if you prefer to play the song live with the backing of the Styles.

Furthermore, to help you organize your show, the SongBook allows you to create various Set Lists, that are collections of Entries that will suit your different types of show, and you can choose with the dedicated buttons on the display.

Choosing the SongBook Entries

Choosing the SongBook Entries from the Book list

A large database is already included with the instrument. You may browse through this database and choose a SongBook Entry.

■ Choose a SongBook Entry

- 1 Press the **BOOK** button in the **SONGBOOK** section to open the **Book** page.

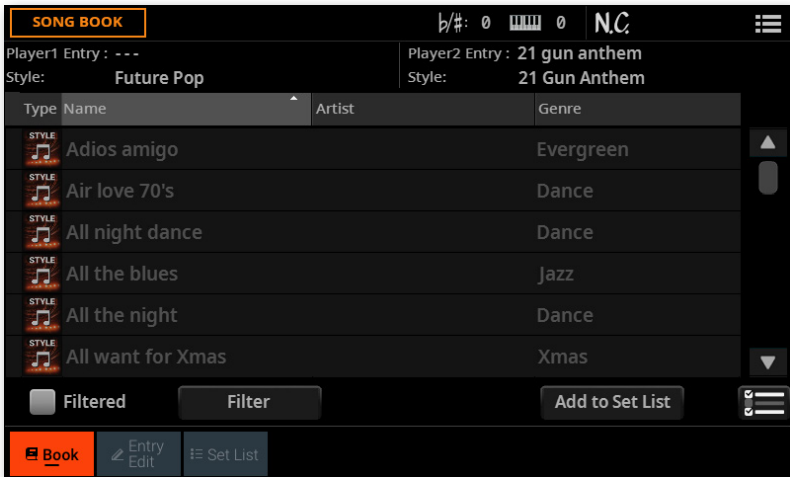

- 2 Browse through the Entries.

Use the **scrollbar** in the display, or the **DIAL** or **UP/DOWN** controls to scroll.

Keep the **SHIFT** button pressed and touch one of the **arrows** of the scrollbar to jump to the previous or next alphabetical section.

- 3 When the Entry you are looking for appears in the display, touch it to assign it to the selected Player.

After choosing the Entry, its name will appear just under the title bar (**Player 1 or 2 Entry**), just above the name of the associated **Style** or **Song**. The name of the **Entry** in the list will appear highlighted.

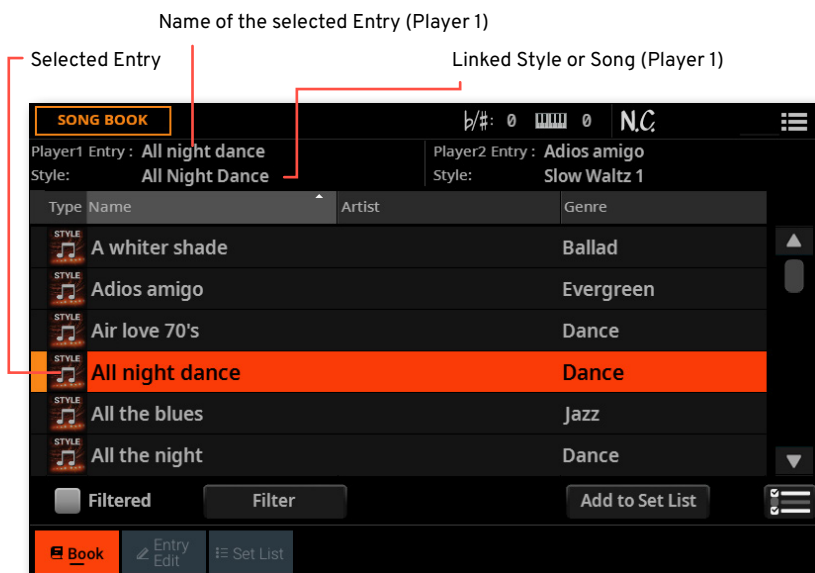



The linked Style and/or Song will be recalled. If at least one of the Players is playing, a Style will be assigned to the selected Player, while a Song will be assigned to other Player.

Pads and Keyboard Sets will also be recalled. If the **Style to Keyboard Set** function is activated, Keyboard Set #1 will be selected. Any TXT file linked to the Entry will be shown in the **Lyrics** page. A Mic and a Guitar Preset will also be recalled. A Chord Sequence might be also loaded.

Identifying the Entries by type

The icons in the **Type** column will help you identify the Entry.

Type	Meaning
	Style-based Entry. When chosen, it will select a Style.
	MIDI Song-based Entry. When chosen, it will select a Song.
	MP3 Song-based Entry. When chosen, it will select a Song.

Playing the SongBook Entries

You can play the selected Entry by using the same Player controls you would use to play a Style or a Song.

■ Play and pause the Style or Song

- > Press the **PLAY/STOP** (▷◻) button to start the SongBook's song. The button's indicator will turn on.
- > Press the **PLAY/STOP** (▷◻) button again to stop it. If it is a MIDI or MP3 Song, it will stop at the current position. The button's indicator will turn off.

■ Fast Forward the MIDI or MP3 Songs

- 1 Press the **USER** mode button in the **CONTROL** section.
- 2 As per factory programming, **BUTTON #4** is the **Fast Forward** command.
 - > Touch the **FAST FORWARD** (≫) button once to jump to the next measure (MIDI Song) or to the next second (MP3 Song).
 - > Keep touching the **FAST FORWARD** (≫) button to scroll the Song continuously. Release it when you have reached the desired position.

■ Rewind the MIDI or MP3 Songs

- 1 Press the **USER** mode button in the **CONTROL** section.
- 2 As per factory programming, **BUTTON #5** is the **Fast Rewind** command.
 - > Touch the **FAST REWIND** (≪) button once to jump to the previous measure (MIDI Song) or to the previous second (MP3 Song).
 - > Keep touching the **FAST REWIND** (≪) button to scroll the Song continuously. Release it when you have reached the desired position.

■ Stop the MIDI or MP3 Song and return to the beginning

- > If the SongBook Entry is linked to a MIDI or MP3 Song, press the **STOP/GO TO START** (◁) button to stop the Player and move to the beginning of the Song. The button's indicator will turn off.

Sorting and filtering the SongBook Entries

Sorting by label/column

On top of the list you can find some labels, each one corresponding to a column of data. Depending on the view preferences, you can see a set chosen between Type, Name, Artist, Genre, Key, BPM, Meter, Number. You can choose one of the labels to sort the list according to that type of data.

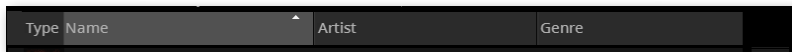

Please note that the **Artist** and **Key** fields of all the supplied Entries have been intentionally left empty.

■ Change the order of the list

- > Reorder the items according to a different **sorting criterion** by touching the corresponding **label** on top of the list.
- > By touching the label again, the order of the items will switch between **ascending** and **descending**.

■ Choose which columns to show

To make the information easier to read, only some of the columns are shown at the same time. You can decide what to show.

- 1 Choose the **Preferences** command from the **page menu** (☰) to open the **Preferences** dialog.

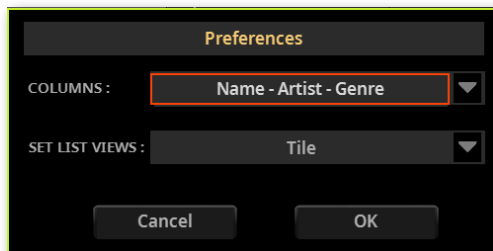

- 2 Use the **Columns** menu to choose one of the predefined sets of columns to be shown.
- 3 When done, touch the **OK** button to close the dialog.

Filtering the Entries

When you are looking for a particular artist, genre or other categories, you may ‘filter’ the list to only see the type of Entries you are looking for. The more database fields (or ‘tags’) are filled in an Entry, the more accurate filtering will be.

Please note that you can also find items inside the SongBook database by pressing the **SEARCH** button on the control panel. But while the **Search** function only searches for names, the **Filter** function allows for a more refined search on multiple parameters at the same time.

■ Open the Filter dialog

> While in the **SongBook > Book** page, touch the **Filter** button to open the **Filter** dialog.

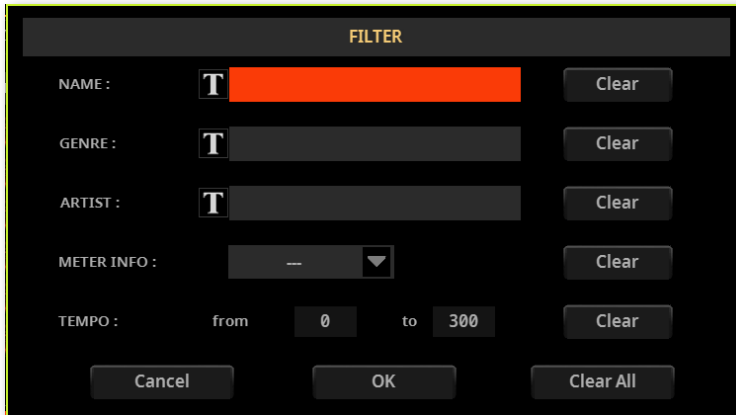

The screenshot shows a dark-themed dialog box titled "FILTER". It contains several input fields and buttons:

- NAME :** A text input field with a "T" icon on the left and a "Clear" button on the right. The field contains a redacted orange bar.
- GENRE :** A text input field with a "T" icon on the left and a "Clear" button on the right.
- ARTIST :** A text input field with a "T" icon on the left and a "Clear" button on the right.
- METER INFO :** A dropdown menu with a downward arrow and a "Clear" button on the right.
- TEMPO :** A range input field with "from" and "to" labels. The "from" field contains "0" and the "to" field contains "300". There is a "Clear" button on the right.

At the bottom of the dialog, there are three buttons: "Cancel", "OK", and "Clear All".

■ Edit the filter criteria and activate the filters

1 Touch the **Text Edit (T)** button next to the **field** you want to edit, to open the **virtual keyboard** and type the **text string** you are looking for.

For example, you may want to find all songs containing the word 'love' in the title (in any position in the string). If so, select the **Name** criterion, and enter the word 'love'. There is no distinction between upper and lowercase.



When done editing the name, confirm by touching the **OK** button under the **virtual keyboard**.

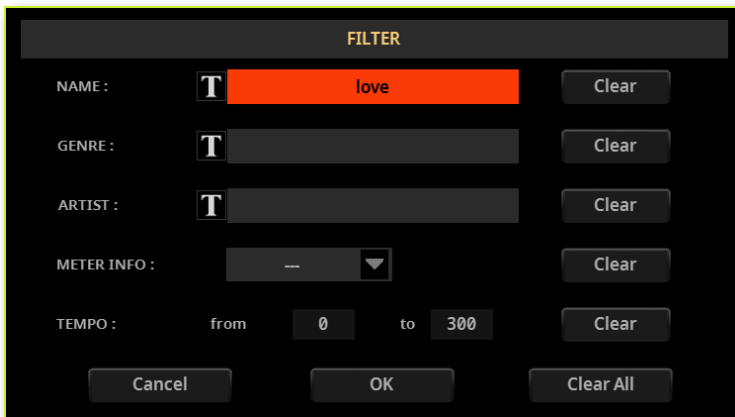

2 Repeat the above step for all the fields you want to include in your filter.

3 If you like, select a **Meter** and/or a range of **Tempo** values to be included in your filter criteria.

■ Delete the filter criteria you don't need

- > Touch the **Clear** button to delete the text string or reset the parameter to a default value.
- > Touch the **Clear All** button to reset all filter criteria.

■ Confirm the filters

- > When done editing the filter parameters, touch the **OK** button to close the **Filter** dialog and return to the **Book** page.

The **Filtered** checkbox will be automatically selected, and the filter will be activated. Only the Entries matching the entered criteria will be shown in the **Book** list.

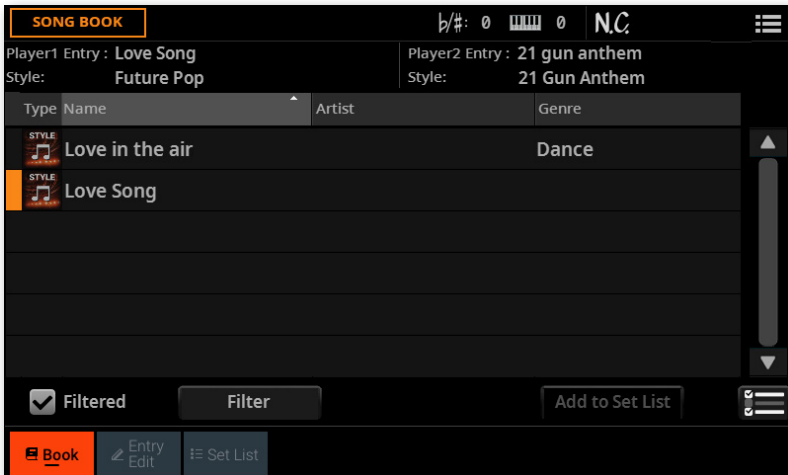

■ Deactivate the filters and see all the Entries again

- > Touch the **Filtered** checkbox to deselect it.

Choosing the SongBook Entries by Song Number

You can select a SongBook Entry by entering its unique **Song ID Number**. Numbers associated with each Entry can be programmed in any of the SongBook Entry edit pages. (See [Editing the Song Selection Number](#) on page 276 for more information).

To help you find a SongBook Entry by ID number, you can export a song list using the **Export Book as Text File** command from the **page menu** (☰), and use it as a reference.

1 To see the numbers while in the **Book** page, be sure the **Number** column is shown.

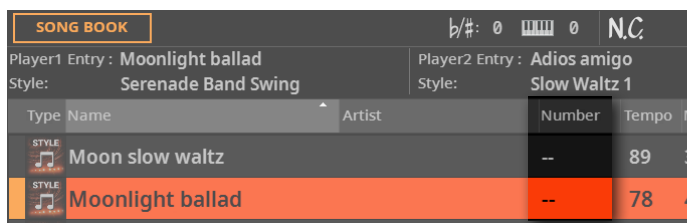

Type	Name	Artist	Number	Tempo	M
STYLE	Moon slow waltz		--	89	3
STYLE	Moonlight ballad		--	78	4

If it is not shown, choose the **Preferences** command from the **page menu** (☰), then use the **Columns** menu to choose one of the options including the **Num** column.

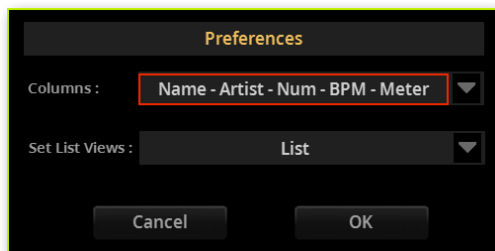

2 To select a SongBook Entry by entering its ID number, press the **BOOK** button again while you are in any page of the SongBook. The **numeric keypad** will appear, allowing you to enter the **ID number** corresponding to the desired Entry.

Please note that you can choose an Entry by ID number even if the **Number** column is not shown.

Quick creation of a new SongBook Entry

Preparing the SongBook Entry

You can save a snapshot of the current status of the instrument in a new SongBook Entry, to be included into the SongBook database.

■ Choose the Style or Song

- Choose a **Style** or **Song** to be assigned to one of the Players.

■ Choose the Tempo, Sounds and the Effects

- You can choose a different Tempo for the Style.
- You can choose different Sounds and Effects for the Style tracks.
- Changes to a MIDI Song's Sounds will not be saved to the SongBook Entry. Only the data included in the MID file will be used. If you want to change them, edit the MID file in **Song Edit** mode.

■ Adjust the other performance settings

- Select the Style Element to be automatically recalled.
- Set the Volume levels and the Play/Mute status for the Style and MIDI Song tracks.

■ Choose the Mic and Guitar Presets

- Choose a **Mic Preset** and/or a **Guitar Preset**, and adjust their parameters.

■ Choose the Pads

- Assign the Pads to the **PAD** buttons.

■ Choose the Chord Sequence

- Choose a **Chord Sequence**, or record a new one that will be saved in the Entry.

Saving the SongBook Entry

You can quickly save the settings into a new SongBook Entry.

1 Keep the **BOOK** button pressed for about one second to create a new SongBook Entry. The **Save SongBook Entry** dialog will appear.

As an alternative, go to one of the SongBook pages, and choose the **Save Book Entry** command from the **page menu** (☰).

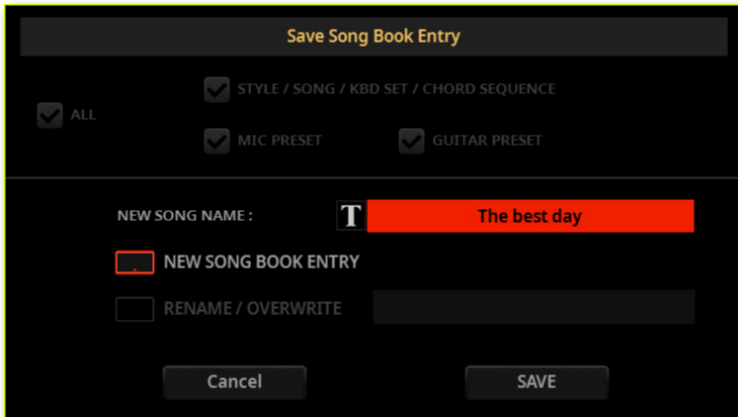

2 If both options are offered (because you had selected a SongBook Entry from the list before editing it), decide if you want to create a new Entry (**New SongBook Entry**), or overwrite the selected one (**Rename/Overwrite**).

3 While in the **Save SongBook Entry** dialog, touch the **Text Edit** (T) button next to the **New Song Name** parameter, to open the virtual keyboard and edit the name of the Entry.

4 After the virtual keyboard has been closed, touch the **OK** button to save the Entry to the SongBook database.

Editing the SongBook

Editing the SongBook Entries

Choosing an existing SongBook Entry

> Choose a SongBook Entry from the **SongBook > Book** or **SongBook > Set List** page.

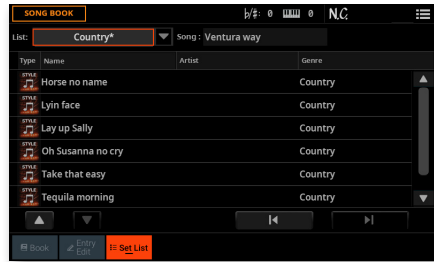
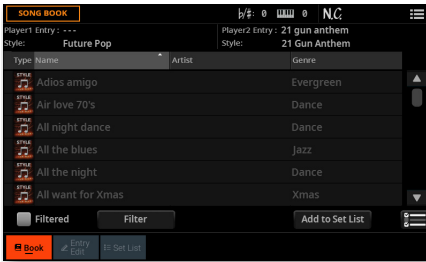

Choosing the Sounds and the Effects

You can exit the SongBook, and repeat the same operations done to create a new SongBook Entry (see [Preparing the SongBook Entry](#) above).

In particular, you can choose a different Keyboard Set, or choose different Keyboard Sounds, Effects, and all the settings for the Sounds and save them into a new Keyboard Set.

You can save up to four Keyboard Sets into the **KEYBOARD SETS** buttons under the **X-FADER**.

All the other elements saved into a SongBook Entry can be edited from the display, as seen in the following pages.

Choosing the Style or Song

With each SongBook Entry, a reference to a Style or Song is saved. When editing an Entry, you can change it with a different Style or Song.

- 1 Choose the **SongBook Entry** to be edited.
- 2 Go to the **SongBook > Entry Edit > Play & KbdSet** page.

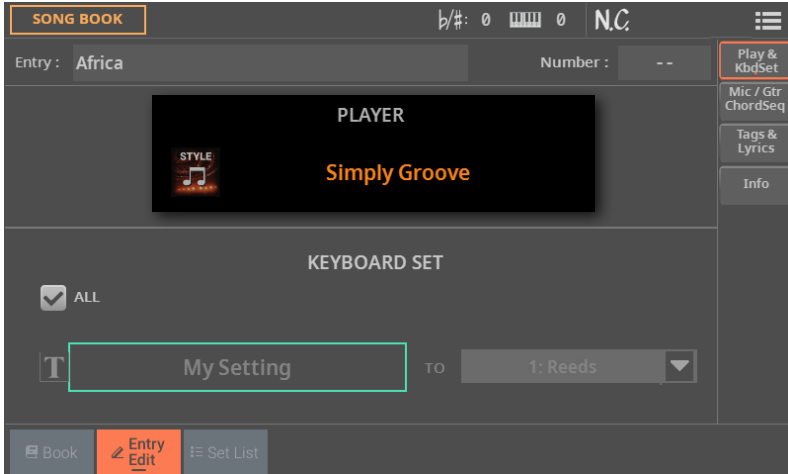

- 3 Touch the **Player** button to open the **Select** window.
- 4 Choose a different Style or Song.

Choosing the Style controls

The selected Style Element, and the status of the Synchro and Memory functions, will be memorized when saving the SongBook Entry.

Choosing the Keyboard Sets

With each SongBook Entry, four Keyboard Sets are saved. When editing an Entry, you can replace the older Keyboard Sets with new ones.

■ Set the starting point

- Choose the **SongBook Entry** to be edited.

■ Edit the Keyboard Sets

- 1 If you want to edit the Keyboard Sets, press the **EXIT** button to exit the SongBook. Don't select a different SongBook Entry!
- 2 If you want, choose a different Keyboard Set from the library.
- 3 Edit the Keyboard Set, by choosing the Sounds, the Effects and the various performing parameters.
- 4 Save the Keyboard Set to the library.

■ Save the Keyboard Sets into the Entry

- 1 Press the **BOOK** button to access the SongBook again.
- 2 Go to the **SongBook > Entry Edit > Play & KbdSet** page.

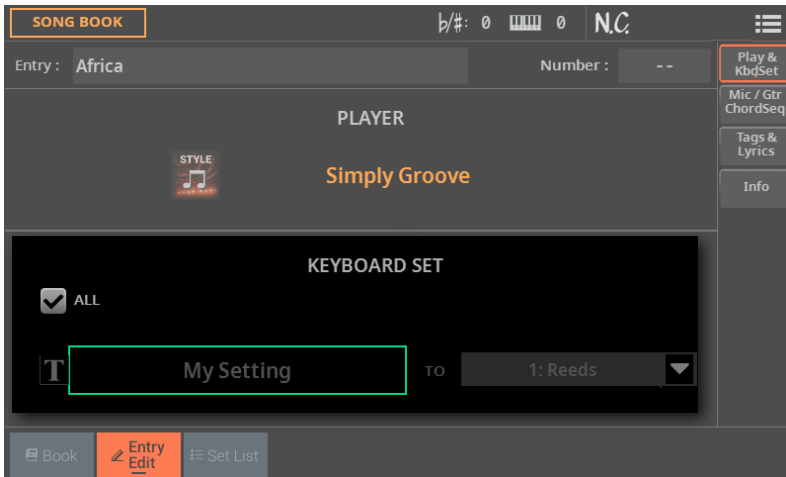

- 3 Use the **Keyboard Set** area to choose the Keyboard Set(s) to save with the SongBook Entry.

4 Use the **All** checkbox to decide if you want to save all the Keyboard Sets (up to four), or just one.

All	Meaning
On	The four Keyboard Sets contained in the KEYBOARD SET buttons under the X-FADER will be saved in the SongBook Entry.
Off	Only the selected Keyboard Set will be saved into the target button.

5 If you deselected the **All** checkbox, choose a **single Keyboard Set location** to save the Keyboard Sounds to the selected Keyboard Set inside the SongBook Entry.

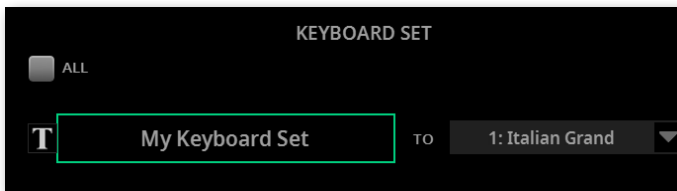

6 After choosing the target location, you can touch the **Text Edit (T)** button and give the Keyboard Set a new name.

7 If you want to save more Keyboard Sets, repeat the above procedure for the other Keyboard Set locations inside the SongBook Entry.

Choosing the Mic Preset and Guitar Preset

With each SongBook Entry are saved references to a Mic Preset and a Guitar Preset. When editing an Entry, you can replace them.

- 1 Choose the **SongBook Entry** to be edited, then go to the **SongBook > Entry Edit > Mic/Gtr/ChordSeq** page.

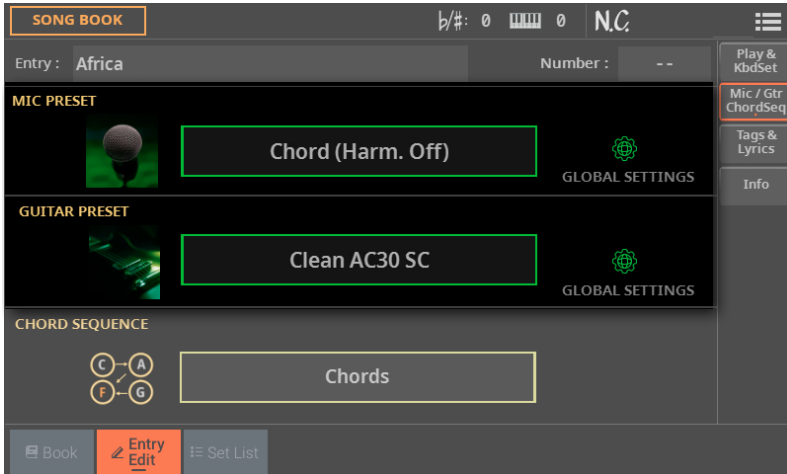

- 2 Touch the **name of the Mic Preset or the Guitar Preset** to open the **Select** window, and choose a preset.
- 3 Select the **Global Settings** checkbox if you want to use the presets chosen in the **Settings > Mic/Guitar Setup > Setup** pages.

Choosing the Chord Sequence

A SongBook Entry may contain a Chord Sequence, to have a sequence or chords good for the song ready.

- 1 Choose the **SongBook Entry** to be edited, then go to the **SongBook > Entry Edit > Mic/Gtr/ChordSeq** page.

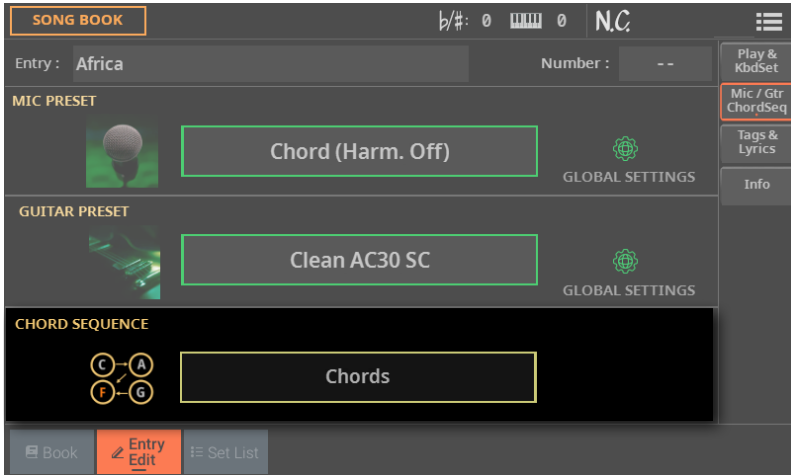

- 2 Touch the **name of the Chord Sequence** to open the **Select** window, and choose a Chord Sequence.

Choosing the Pads

With each SongBook Entry, four Pads are saved. When editing an Entry, you can save or replace the selected Pads.

- 1 Choose the **SongBook Entry** to be edited, and press the **EXIT** button to exit the SongBook. Don't select a different SongBook Entry!
- 2 Go to the **Home > Menu > Pads** page, and touch the **names of the Pads** to choose up to four Pads.

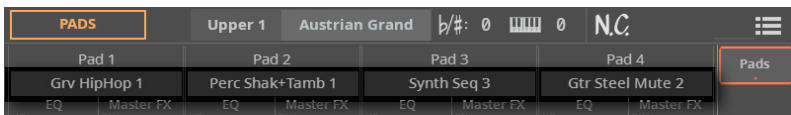

- 3 Press the **BOOK** button to return to the **SongBook** pages.

Editing the Song Selection Number

Each SongBook Entry can have a unique ID number (up to 9,999). You can type them to quickly recall an Entry (see [Choosing the SongBook Entries by Song Number](#) on page 267 for more information).

Assigning a number is not mandatory, but may help in quickly recalling the Entries, and as an alternative way of organizing them. For example, you may use the different 100s to create a different way of categorizing your entries by genre or age.

To help you find a SongBook Entry by ID number, you can export a song list using the **Export as Text File** command from the **page menu** (☰), and print it.

- 1 Choose the **SongBook Entry** to be edited.
- 2 Go to the **SongBook > Tags & Lyrics** page.



- 3 Touch the **Number** parameter to open the virtual numeric keypad, and enter the ID number.

Editing the database tags

The SongBook is a database. You can add to each SongBook Entry special archival data, or tags, that will later help in retrieving specific types of songs by using the **SongBook > Book > Filter** function.

- 1 Choose the **SongBook Entry** to be edited.
- 2 Go to the **SongBook > Tags & Lyrics** page.

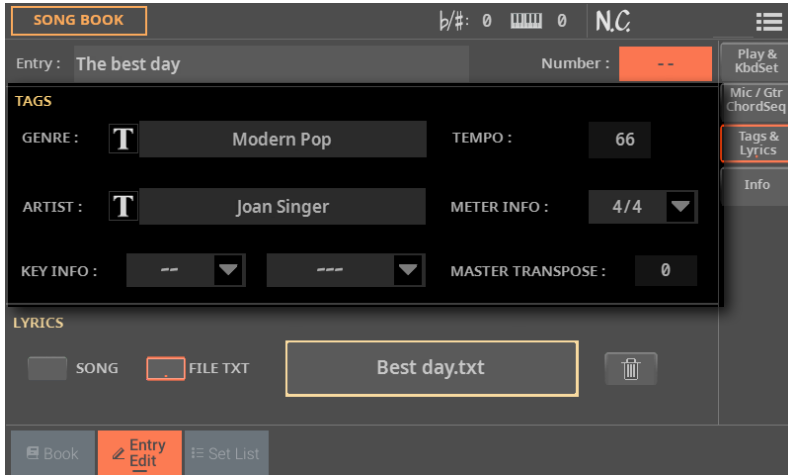

3 Edit the SongBook Entry's **database tags**.

Tag	Style-based Entry	MID-based Entry	MP3-based Entry
Genre	Music genre associated with the Entry.		
Artist	Name of the artist of the song associated with the Entry.		
Key Info	Original key of the Entry. The first field is the Root, the second one is the Major/minor mode.		
Tempo	Entry's Tempo. This may change, if a Tempo Change event is included within the associated resource. You can manually change this value by using the TEMPO buttons on the control panel. Any change will only be shown after saving the Entry.		
	Original Tempo of the Style.	Original starting Tempo of the MID file.	Always zero (original Tempo of the MP3 Song).
Meter Info	Entry's Meter (or 'Time Signature'). This may change, if a Meter Change event is included within the associated resource.		
Master Transpose	Entry's Master Transpose value. When the Entry is selected, the Master Transpose of the whole instrument is automatically changed (unless it is not locked). The Master Transpose value saved in the SongBook Entry overrides any Master Transpose setting contained in the associated resource. You can manually change this value by using the TRANSPOSE buttons on the control panel. Any change will only be shown after saving the Entry.		

Linking a text file to the SongBook Entry

You can add Lyrics to any Entry as a linked TXT file. Since there is no automatic synchronization between this type of Lyrics and the associated Style or Song, you will have to scroll them manually (as explained in [Reading the lyrics and chords loaded as a text file](#) on page 235).

■ Link Lyrics as a TXT file

- 1 Choose the **SongBook Entry** to be edited.
- 2 Go to the **SongBook > Tags & Lyrics** page.

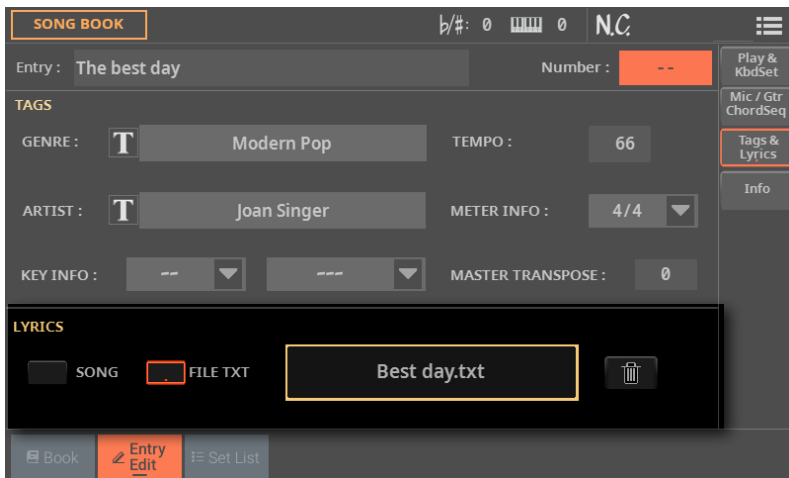

- 3 Touch the **name of the TXT file** to open the file selector, and choose a TXT file to be linked to the current SongBook Entry.

After having been selected, the name of the linked text file will appear.

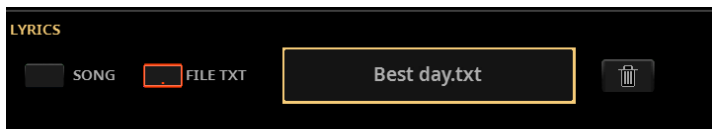

- 4 Use the **Song/File TXT** radio-button to choose whether the Lyrics have to be read from the internal MIDI file data, or from the linked TXT file. This selection is only allowed if both types of Lyrics are available.

■ Unlink the TXT file

- > While in the same page, touch the **Delete** () button.

Checking the Information for the SongBook Entry

You can see some information on the selected SongBook Entry, to check, for example, the name of the Entry, the linked Style or Song, Chord Sequence and TXT file (if any).

- 1 Choose the **SongBook Entry**.
- 2 Go to the **SongBook > Entry Edit > Info** page.

If you selected a **Style-based Entry**:

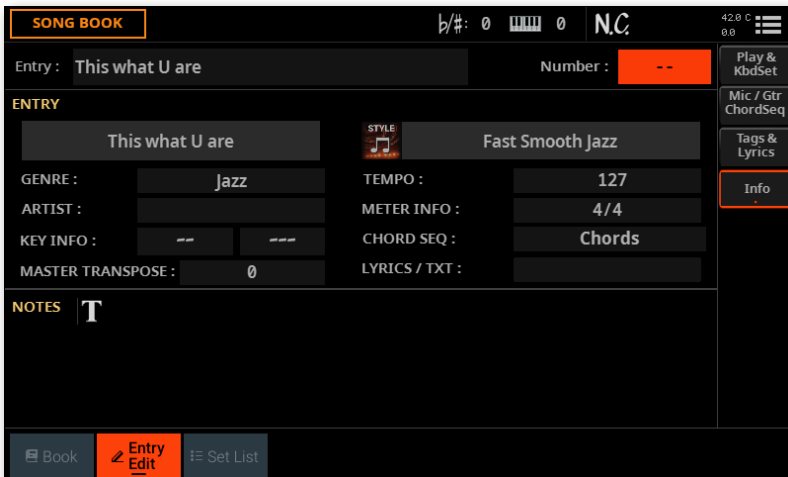

If you selected a **Song-based Entry**:

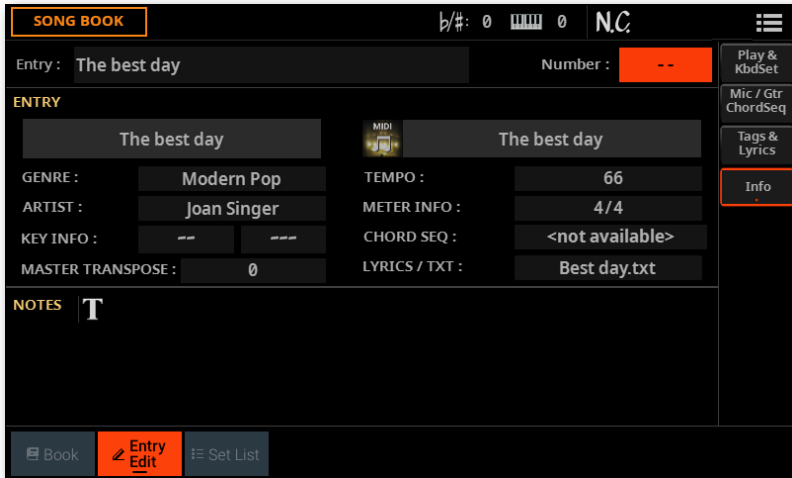

Adding notes to a SongBook Entry

You can add written notes to the entry.

- 1 Choose the **SongBook Entry** to be edited.
- 2 Go to the **SongBook > Entry Edit > Info** page.

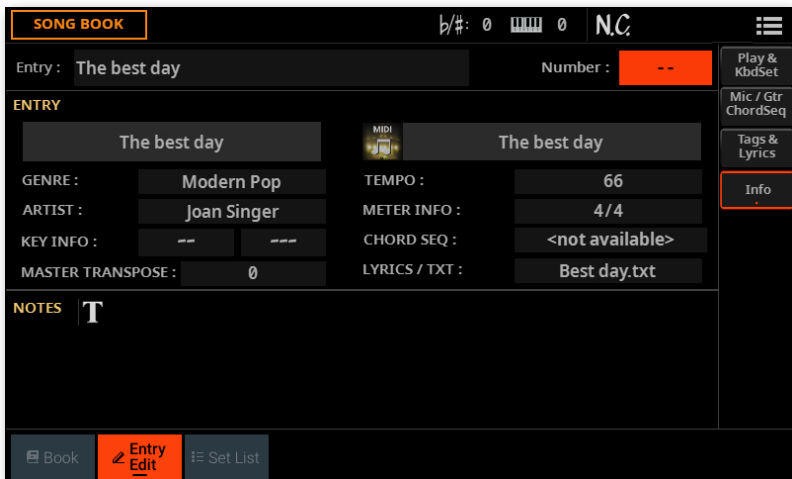

- 3 Touch the **Text Edit (T)** button to add the written note.
- 4 When done, touch the **OK** button to confirm the entered note.

Saving the SongBook Entry

You can save your edits over a new or existing SongBook Entry.

1 Choose the **Save Book Entry** command from the **page menu** (☰). The **Save SongBook Entry** dialog will appear.

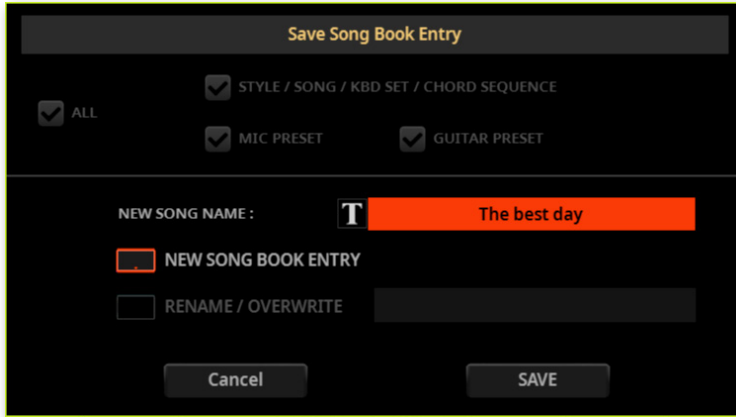

2 Choose whether you want to create a new Entry (**New SongBook Entry**), or overwrite the one you just edited (**Rename/Overwrite**).

3 Touch the **Text Edit (T)** button next to the **New Song Name** parameter, to open the virtual keyboard and edit the name of the Entry.

4 After the virtual keyboard has been closed, touch the **OK** button to save the Entry to the SongBook database.

Managing the SongBook Entries

Selecting the SongBook Entries

Multiple selection of SongBook Entries

While in the **Book** page of the **SongBook**, you can select several Entries at the same time before executing an operation.

■ Set the Select mode

> While in **Book** page, use the **Selection Mode** button to decide either to select the Entries in a consecutive or separate way.

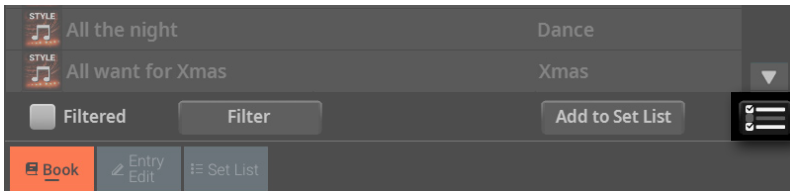

Selection Mode

Meaning



Choose this option to select the target Entries separately (i.e., with other non-selected Entries in the middle).



Choose this option to select the target Entries consecutively (i.e., all in a row).

■ Select multiple Entries separately

- 1 Touch the **Select Mode** button to choose the **SHIFT** function.
- 2 Select the first Entry to be selected.
- 3 Press and keep the **SHIFT** button pressed.
- 4 Select a second Entry to be selected.
- 5 While keeping the **SHIFT** button pressed, continue selecting the other Entries to be selected.
- 6 Release the **SHIFT** button.

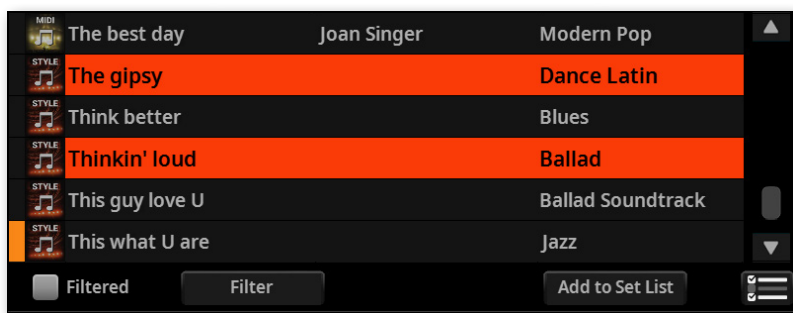

■ Select multiple Entries consecutively

- 1 Touch the **Select Mode** button to choose the **SHIFT** function.
- 2 Select the first Entry to be selected.
- 3 Press and keep the **SHIFT** button pressed.
- 4 Select the last Entry to be selected.
- 5 Release the **SHIFT** button.

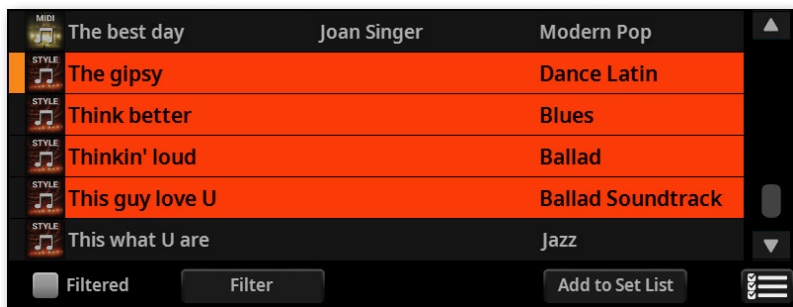

■ Deselect the Entries

- > To deselect one or more Entries, without deselecting everything, keep **SHIFT** pressed and touch the items to be deselected.
- > To deselect everything, select any other Entry. All selected Entries will be deselected.

Selected and active SongBook Entries

In the **Book** and **Set List** pages (**List View** mode), an Entry that is selected in the list and active is shown with a vertical line next to its name. Orange if it is assigned to Player 1, blue if assigned to Player 2.



If you select a different Style or Song, the Entry remains selected in the list, but it is no longer active, since its content has been replaced by a different Style or Song. The vertical line disappears.



If the Entry is still active, but you have deselected it (by keeping the **SHIFT** button pressed and touching the Entry's name), the vertical line is still shown, but the Entry's name is no longer highlighted. Any operation on the list will have no effect on this Entry.



Deleting the SongBook Entries

- 1 While in the **SongBook > Book** page, select the song (or songs) to be deleted.
- 2 Choose the **Delete Book Entry/Entries** command from the **page menu** () , then confirm.

Deleting all the SongBook Entries and Set Lists

You may want to create you own Book list, after removing all the existing Entries and Set Lists.

- 1 Go to any of the **SongBook** pages.
- 2 Choose the **Delete Whole Book** command from the **page menu** () , then confirm.

Please note that this operation will permanently delete all the Entries and the Set Lists. To preserve the data you ware going to delete:

- > A copy of the original factory data is always stored in a protected area of the internal memory. You can recover them by using the **Factory Restore** command in the **File > Menu > Factory Restore** page, and only selecting the **SongBook** as the type of data to restore.
- > You can make a copy of an edited SongBook. For more information, see [Copying and moving data on page 665](#).

Using the Set Lists

What are the Set Lists?

Set Lists are selections from the full Book list. They allow for smaller, customized lists, suitable for a single gig or your own music preferences. We already included some sample lists, that you can use for your own shows.

Choosing the Tile or List View

Set Lists can be used in Tile View or in List View. In **Tile View**, songs are shown as pages of tiles that you can quickly select by touching them. In **List View**, all songs are shown in a plain list, that you might prefer when playing the songs in a list one after the other.

■ Switch between Tile View and List View

1 While in any **SongBook** page, choose the **Preferences** command from the **page menu** (☰) to open the **Preferences** dialog.

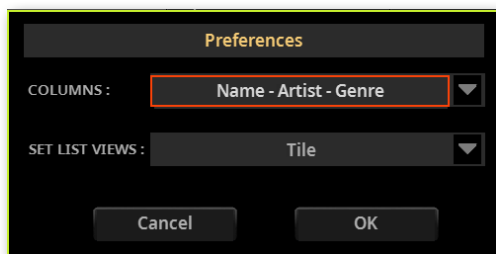

- 2 Use the **Set List Views** menu to switch between the Tile View and List View.
- 3 When done, touch the **OK** button to close the dialog.

Playing a Set List from the Tile View

The **Tile View** shows the selected Set List as a set of songs assigned to the **SET LIST** buttons in the display.

■ Choose the Set List

- 1 Go to the **SongBook > Set List** page. You can press the **SET LIST** button to open this page.
- 2 Be sure you are in **Tile View**, otherwise choose the **Preferences** command from the **page menu** (☰) to open the **Preferences** dialog, and select it.

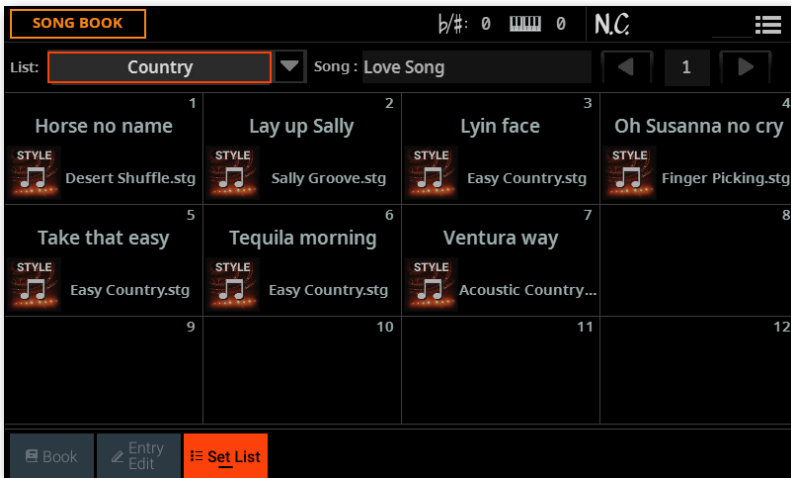

- 3 Use the **List** pop-up menu to select one of the available Set Lists. The songs in the selected set are assigned to the **SET LIST** buttons in the display.

■ Choose a page

The songs in the selected Set List are organized in ‘pages’ of twelve.

- > Use the **page indicator** in the top right corner of the page to go to a different page inside the selected Set List.

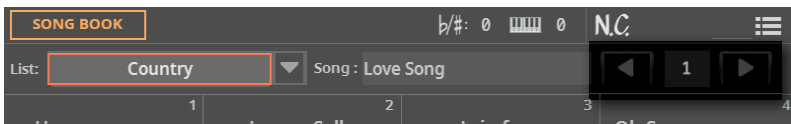

■ Choose a SongBook Entry

- 1 Be sure you are in the **SongBook > Set List** page.
- 2 Touch one of the **tiles** in the display, to choose the corresponding song. The selected song will appear highlighted.

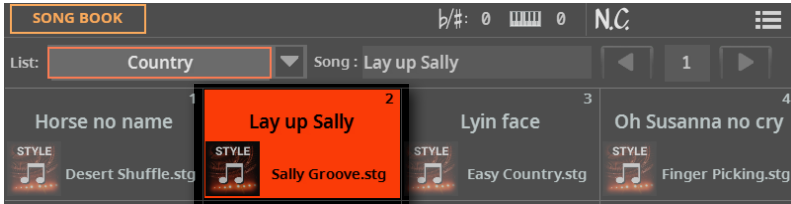

■ Play the Set List

- > Use the **PLAY/STOP** (▶□) button to start and stop playback of the selected Style or Song.
- > Use the standard **Player controls** to start, pause or stop the Styles or Songs.
- > Move to a different song by touching the corresponding **tile**.

Playing a Set List from the List View

The **List View** shows the selected Set List as a plain list of songs.

■ Choose the Set List

- 1 Press the **SET LIST** button to open the **SongBook > Set List** page.
- 2 Be sure you are in **List View**, otherwise choose the **Preferences** command from the **page menu** (☰) to open the **Preferences** dialog, and select it.

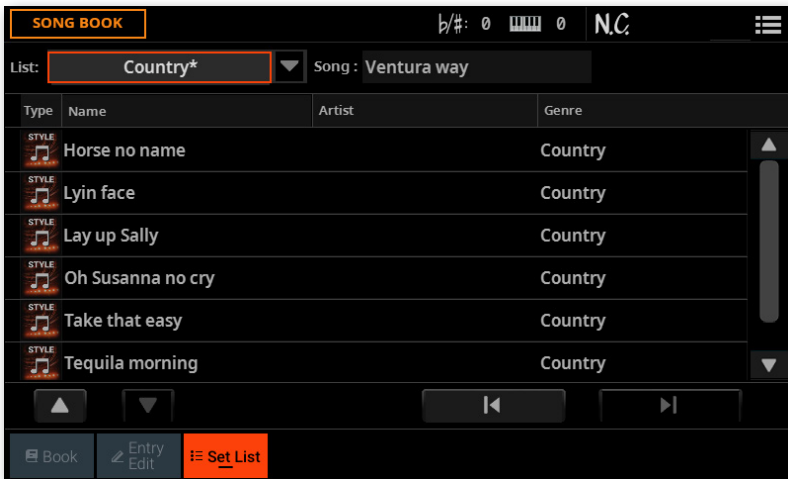

- 3 Use the **List** pop-up menu to select one of the available Set Lists. The list of songs in the selected Set List will appear.

■ Choose a SongBook Entry

- 1 Be sure you are in the **SongBook > Set List** page.
- 2 Browse through the Entries in the list.

3 Touch the **name of the Entry** you want to choose. The selected song will appear highlighted.

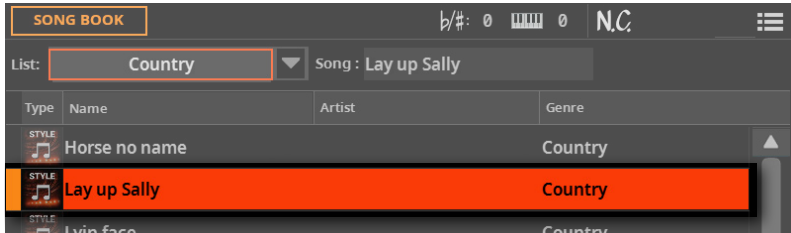

■ Play the Set List

- > Use the **PLAY/STOP** (▶□) button to start and stop playback of the selected Style or Song.
- > Use the standard **Player controls** to start, pause or stop the Styles or Songs.
- > Select a different song by touching the corresponding **name** in the list.
- > If you want to immediately jump to the previous or next song, use the dedicated **Select Previous** and **Select Next** buttons under the list.



The color of the selection will always let you know if the song is assigned to Player 1 (orange) or Player 2 (blue).

Editing the Set Lists

Creating a new Set List

Creating or editing a Set List

> Go to the **SongBook > Set List** page, then choose the **New Set List** command from the **page menu** (☰).

A new, blank list will be created and automatically selected.

Editing the Set Lists

You can add, delete or reorder items from a Set List. The name of a modified Set List shows an asterisk (*) after the name.

Selecting a Set List for editing

- 1 Go to the **SongBook > Set List** page. Choose either the List View or Tile View.
- 2 Use the **List** pop-up menu to select the Set List to edit.

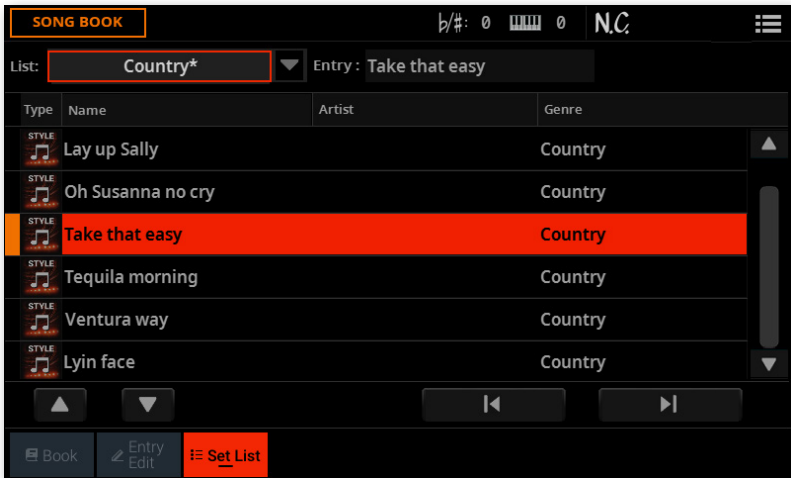

Adding songs to the selected Set List

- 1 Go to the **SongBook > Book** page.
- 2 Browse through the songs in your SongBook database.
- 3 When you see the **song** you are looking for, touch it. If you want to select multiple songs at the same time, keep the **SHIFT** button pressed, and select the songs.

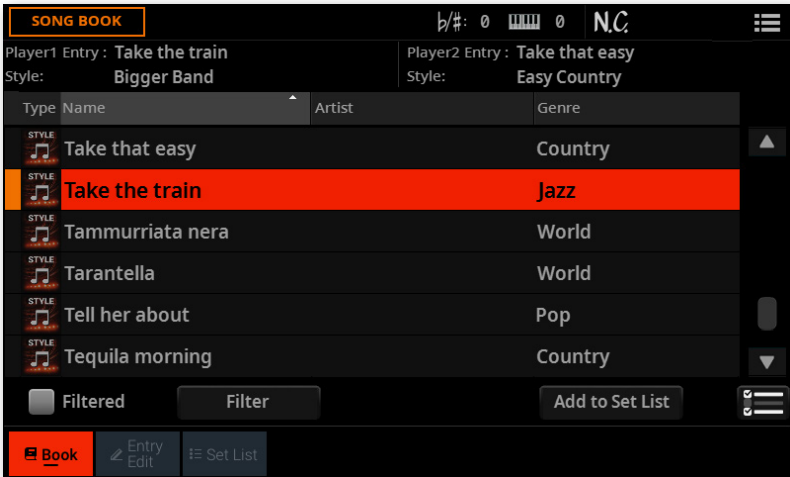

- 4 Touch the **Add to Set List** button to add the selected song(s) to the selected Set List.

Rearranging the songs in the list

If the order of the songs added to the list is not the desired one, rearrange them. This can be done while in List View.

- 1 Go to the **SongBook > Set List** page, and choose the Set List you want to edit.

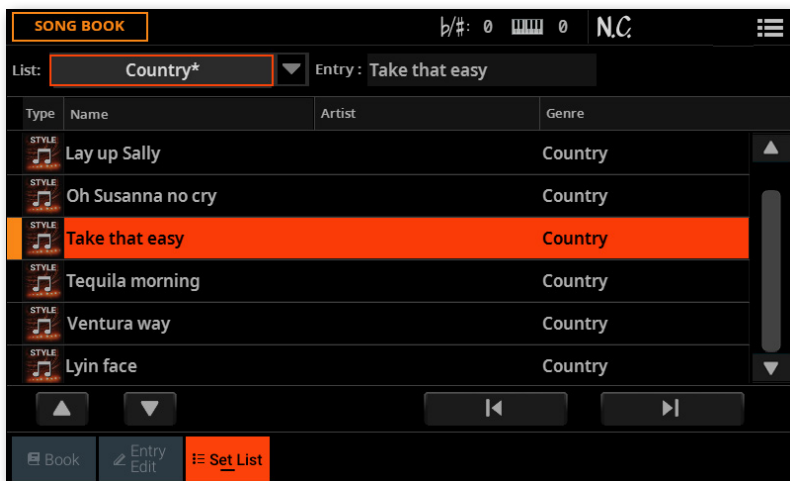

- 2 Touch the **song** you want to move.
- 3 Use the **Move > Up** (▲) and **Move > Down** (▼) buttons on the display to move the selected song to a different position in the list.

Deleting unwanted songs from the list

- 1 Go to the **SongBook > Set List** page, and choose the Set List you want to edit.
- 2 Touch the **song** you want to delete from the list.
- 3 Choose the **Delete Set List Entry** command from the **page menu** (≡), then confirm.

The song will be deleted from the Set List, but it will not be deleted from the Book list.

Saving a Set List

1 While in the **SongBook > Set List** page, choose the **Save Set List** command from the **page menu** (☰) to open the **Save List** dialog.

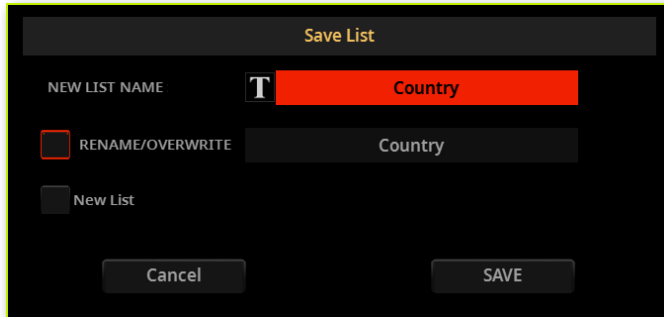

2 Choose the **Rename/Overwrite** option to save over the selected Set List. If you prefer to create a new Set List, choose the **New List** option instead.

3 Touch the **Text Edit (T)** button if you want to assign the Set List a different name. Edit the name and confirm to return to the **Save List** dialog.

4 When done, touch the **OK** button to confirm saving the list.

Deleting a Set List

1 While in the **SongBook > Set List** page, use the **List** pop-up menu to select the Set List to delete.

2 Choose the **Delete Set List** command from the **page menu** (☰), then confirm.

The songs contained in the list will not be deleted from the Book list.

Exporting the Book and Set Lists as a text file

A list of the songs contained inside the Book and Set Lists can be exported, to be used as the playlist of the show.

- 1 While you are in the **SongBook > Book** or **Set List** page, choose the desired list order and filtering.
- 2 Choose the **Export Book/Set List as Text File** command from the **page menu** () to open the **Export as Text File** dialog.

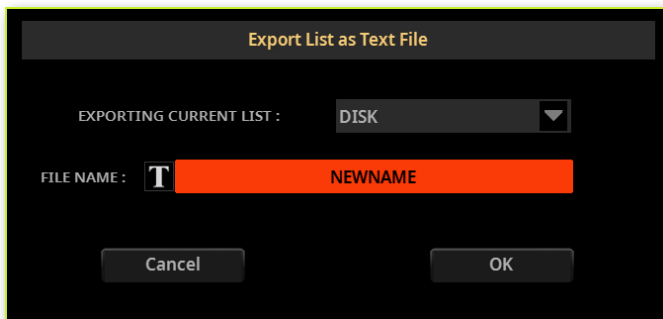
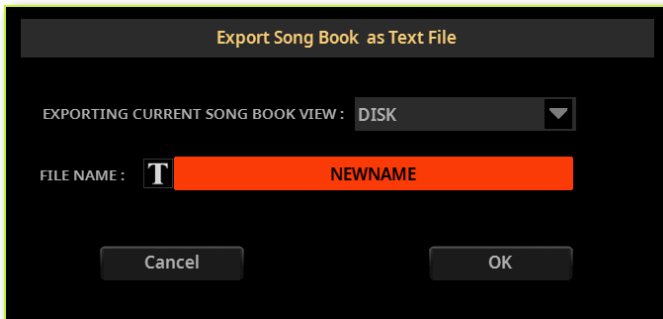

3 Use the **Device** pop-up menu to choose a device where to save the list as a TXT file. The file will be saved in the device's root.

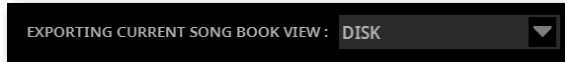

4 You may change the **name** of the list. Touch the **Text Edit (T)** icon to open the **virtual keyboard** and edit the name. When done editing the name, confirm by touching the **OK** button under the virtual keyboard.

5 When back at the **Export as Text File** dialog, confirm exporting by touching the **OK** button.

A TXT file containing the filtered data will be created. If a file with the same name already exists on the target device, it will be overwritten without waiting for confirmation.

To correctly display and print the list on a personal computer, use a fixed width (i.e., non-proportional) character in your text editor.

Using the SongBook with a tablet or personal computer

Choosing the SongBook Entries via MIDI

SongBook Entries can be remotely selected via MIDI. In addition, MIDI messages can be sent via MIDI when choosing a SongBook Entry. This is useful to synchronize Pa5X to a digital music sheet reader (for example, a dedicated app running on a tablet).

When using Pa5X with a tablet, you should also program the app on the tablet. Please refer to the app's user manual for more information. The supplied MIDI Preset is a starting point for setting the various parameters, but you may have to adapt them to the software.

Choosing the Tablet MIDI Preset

The **Tablet** MIDI Preset programs MIDI channel #16, so that it is used to send MIDI messages when selecting the SongBook Entries, or to receive MIDI messages to selecting them from an external device.

> Go to the **Settings > Menu > MIDI > General Controls** page and choose the **Tablet** MIDI Preset.

Editing an existing MIDI Preset

You can program or edit your own MIDI Preset for selecting SongBook Entries. A special MIDI channel used as the Control channel is needed to send MIDI messages to select the SongBook Entries, or to receive MIDI messages when selecting them.

■ Configure the Control channel

- 1** Go to the **Settings > Menu > MIDI > General Controls** page and choose a MIDI Preset to be used as a starting point.
- 2** Go to the **Settings > Menu > MIDI > Midi In Channel** page, and assign the Control option to one of the sixteen available MIDI channels (usually one of the higher-numbered ones, for example #16).
- 3** Go to the **Settings > Menu > MIDI > Midi Out Channel** page, and assign the Control option to one of the sixteen available MIDI channels (the same as on the MIDI IN will work fine).
- 4** Go to the **Settings > Menu > MIDI > Filters** page, and be sure no needed type of data is filtered out.
- 5** When done, save these settings to a new or existing MIDI Preset, by choosing the **Save Midi Preset** command from the **page menu** ()

Selecting the SongBook Entries via MIDI

At this point, Pa5X must receive on the special Control channel the NRPN Control Change messages #99 (MSB, with value 2) and #98 (LSB, with value 64) in fast succession, as an initialization string. This string must be sent only once, unless another NRPN control is sent on the same MIDI channel before selecting a different SongBook Entry.

After the initialization string has been sent, you must send the selection string, made of two Control Change messages: CC#06 (Data Entry MSB) for the thousands and hundreds, and CC#38 (Data Entry LSB) for the tens and units. The range of the Data Entry controls, in this case, is 0~99 (instead of the typical 0~127).

The following examples show some typical situations.

- > Send the following string to select SongBook Entry #77:

Data 1	Data 2	
NRPN MSB	2	Initialization string (CC#99, 98)
NRPN LSB	64	
DataEnt MSB	0	Thousands and hundreds (00xx)
DataEnt LSB	77	Tens and units (xx77)

- > Send the following string to select SongBook Entry #100:

Data 1	Data 2	
NRPN MSB	2	Initialization string (CC#99, 98)
NRPN LSB	64	
DataEnt MSB	1	Thousands and hundreds (01xx)
DataEnt LSB	0	Tens and units (xx00)

- > Send the following string to select SongBook Entry #2563:

Data 1	Data 2	
NRPN MSB	2	Initialization string (CC#99, 98)
NRPN LSB	64	
DataEnt MSB	25	Thousands and hundreds (25xx)
DataEnt LSB	63	Tens and units (xx63)

Sending MIDI messages when selecting SongBook Entries

When the special Control channel is assigned to one of the MIDI OUT channels, MIDI messages are sent on this channel when choosing a SongBook Entry. The messages sent when selecting a SongBook Entry are the following (as seen in the previous section):

- > An initialization string, made of the NRPN Control Change messages #99 (MSB, with value 2) and #98 (LSB, with value 64) in fast succession.
- > A selection string, made of the two Control Change messages CC#06 (Data Entry MSB) for the thousands and hundreds, and CC#38 (Data Entry LSB) for the tens and units. The range of the Data Entry controls, in this case, is 0~99 (instead of the typical 0~127).

12

The Matrix

Using the Matrix

The **Matrix** lets you create up to three sets of **Matrix Pads**, that you can quickly select by choosing one of the **Matrix Presets 1-3**. It also offers a set of **Mute** controls.

The Pads are illuminated according to the color of the current Player (orange for Player 1, blue for Player 2).

Using the Matrix Pads from the control panel

1 While in any of the **Home** pages, press one of the **Matrix Preset 1-3** buttons under the **Matrix Pads**, to select the corresponding set of Pads.

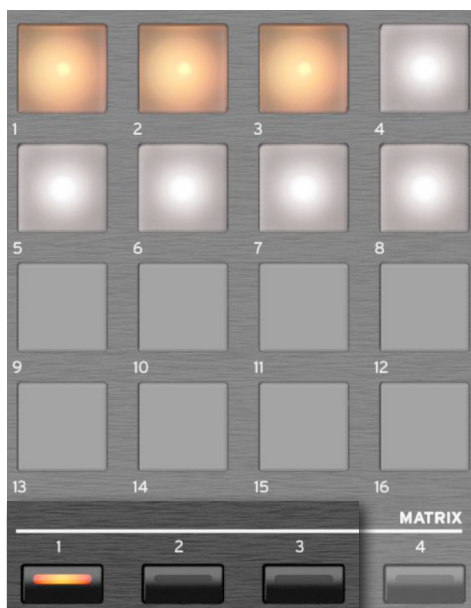

2 Press one of the **Matrix Pads** to trigger the corresponding Pad. If it is a looping sequence, press it again to stop it.

Using the Matrix Pads from the display

- 1 While in the **Home** page, touch the **Matrix** tab to open the corresponding pane.



- 2 Touch one of the **Pads 1-3** buttons to activate the corresponding set of Pads.
- 3 Touch one of the **Matrix Pads** to trigger the corresponding Pad. If it is a looping sequence, press it again to stop it.

Using the Matrix Mute buttons from the control panel

1 While in any of the **Home** pages, press the **Matrix Preset 4** button under the **Matrix Pads**, to select the **Matrix Mute buttons**.

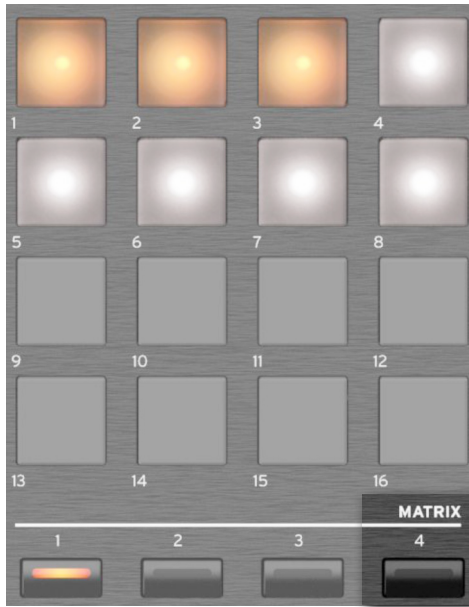

2 Press one of the **Matrix Pads** to enable the corresponding Mute. Press it again to unmute the corresponding track.

You can see the corresponding tracks in the **Home > Control** pane.

Using the Matrix Mute buttons from the display

- 1 While in the **Home** page, touch the **Matrix** tab to open the corresponding pane.

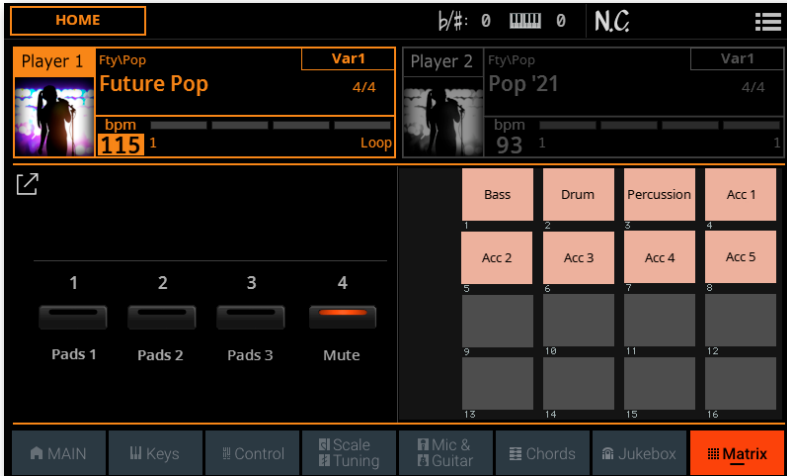

Matrix Mute with a Style selected

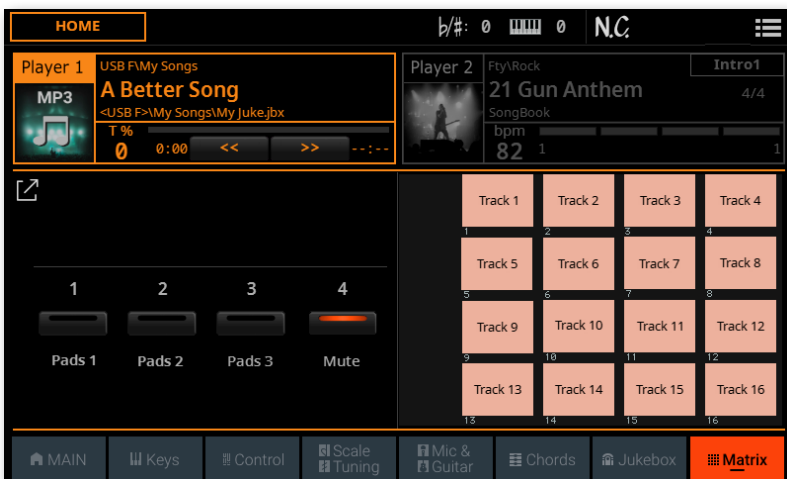

Matrix Mute with a MIDI Song selected

- 2 Touch the **Pads 4** button to activate the **Matrix Mute buttons**.
- 3 Touch one of the **Matrix Pads** to enable the corresponding Mute. Touch it again to unmute the corresponding track.

Programming the Matrix

While the Mute set is fixed, you can program the three Matrix Pad sets.

- 1 While in the **Home** page, touch the **Matrix** tab to open the corresponding pane.
- 2 Choose one of the **Pads 1-3** sets.



- 3 Touch the **Expand** () button to see the Expanded view of the **Matrix** pane.

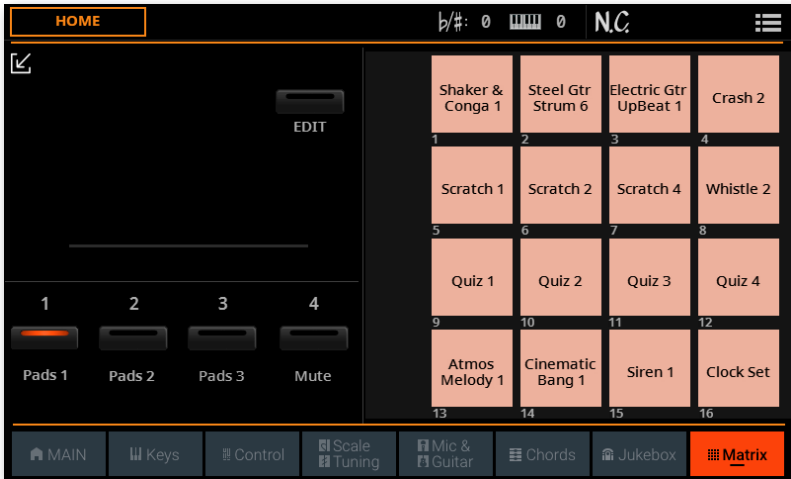

- 4 Touch the **Edit** button to put the set in edit mode.



5 While in edit, you can touch one of the **Matrix Pads** to open the **Pad Select** window.



6 Select the **Pad** to be assigned to the selected **Matrix Pad**, then press the **EXIT** button to return to the **Matrix** pane.



7 If you want to remove one of the Pads, touch the **Delete (X)** button in the top right corner of the Matrix Pad.

8 Touch the **Edit** button again to exit the edit mode.

- 9 Touch the **Collapse** (☐) button to return to the Normal view of the **Matrix** pane.



Changes to your programming will be saved automatically as global settings.

In case you want to restore the original factory settings, use the **Factory Restore** command you can find in the **File > Menu > Restore** page.

WARNING: This operation will overwrite all the User data!

CUSTOMIZE

13

**Editing
and saving
the Sound
combinations**

Editing the Sound combinations

What is a 'Sound combination'?

In Pa5X, Sounds are organized into groups sounding together. To call these group with a collective noun, we call them 'Sound combinations'. They can be saved to a common structure that can later be recalled at once.

The available combinations are the Keyboard Sounds, the Pad Sounds, the Style Sounds, the MIDI Song Sounds. The corresponding structures where you can save them into are the Keyboard Set, the Style, the MIDI Song, the SongBook Entry.

A - Choose a Sound combination

Sound combinations are groups of Sounds that are selected all at the same time. They can be found in the following places. Please note that you can only edit and save User elements (Factory elements are protected).

Sound combination	Type
Keyboard Sets (from the library)	Sounds assigned to the keyboard, saved in the KEYBOARD SET LIBRARY.
Keyboard Sets (from a Style)	Sounds assigned to the keyboard, saved in the KEYBOARD SET section and selected with the Styles.
Keyboard Sets (from a SongBook Entry)	Sounds assigned to the keyboard, saved in the KEYBOARD SET section and selected with a SongBook Entry.
Style Sounds (from a Style)	Sounds of the Style tracks. You can save them with the Style, but they might be automatically changed by the Program Change messages contained inside the Style's MIDI sequences. You can edit and save these messages in Style Edit mode.
Style Sounds (from a SongBook Entry)	Sounds of the Style tracks, selected with a SongBook Entry.
Song Sounds (from a MIDI Song)	Sounds or a MIDI Song tracks. You can save them with the Song, but they might be automatically changed by the Program Change messages contained inside the MIDI Song. You can edit and save these messages in Song Edit mode.

Sound combination	Type
Song Sounds (from a SongBook Entry)	Sounds of a MIDI Song tracks, selected with a SongBook Entry.
Pad Sounds (from the library)	Sounds assigned to the Pads.
Pad Sounds (from a SongBook Entry)	Sounds of the Pad tracks, selected with a SongBook Entry.

Choosing a Keyboard Set from the library

- > Choose from the **KEYBOARD SET LIBRARY** section the **Keyboard Set** whose Sounds you want to edit.

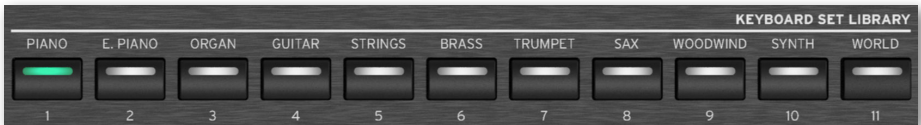

Choosing a Keyboard Set from the current Style

- > Choose a **Style**, then the **Keyboard Set** (from the **KEYBOARD SET** section under the **X-FADER**) whose Sounds you want to edit.



Choosing a Style from the Library

- > Choose the **Style** whose Sounds you want to edit. Please note that you can only save the changes into the User Styles (not the Factory ones).



Choosing a MIDI Song

- > Choose the **MIDI Song** whose Sounds you want to edit.



Choosing a Pad from the library

- > Choose a Pad in the **Home > Menu > Pads** page.

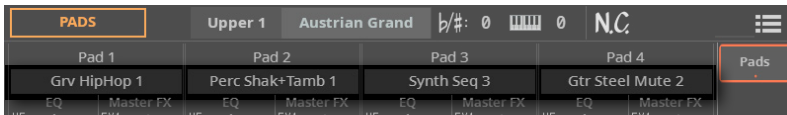

Choosing a Keyboard Set, a Pad, a Style or a MIDI Song by selecting a SongBook Entry

- > Press the **BOOK** or **SET LIST** button, and choose a SongBook Entry containing the Keyboard Set, the Pad, the Style or the MIDI Song whose Sounds you want to edit.



B - Access editing

The edit pages can be accessed by pressing the **MENU** button. They are organized in sections.

- 1 Be sure to be in the **Home** mode (the one appearing when turning the instrument on). If not, press the **EXIT** button to get there.
- 2 Press the **MENU** button to access editing and see the **Home** mode's **edit menu**. You will see the **edit sections** as big buttons.

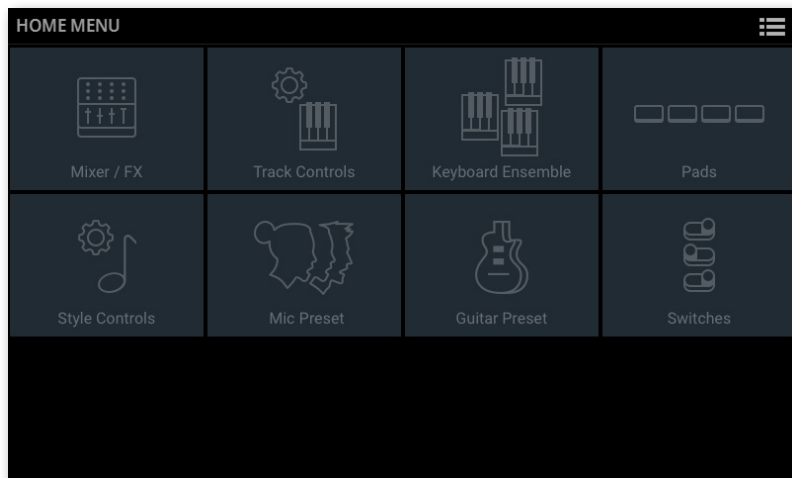

- 3 Choose an **edit section** and **edit page** to access the parameters.

C - Choose a Sound to edit

Most editing is done on the selected Sounds. These can be Sounds playing on the keyboard, or from a Pad, a Style or a MIDI Song.

Switching between the Keyboard, Pad, Style and MIDI Song Sounds

➤ Repeatedly touch the **TRACK SELECT** button in the lower right corner of the page. The display will cycle between the Keyboard and Pad, and the Style or Song Sounds.

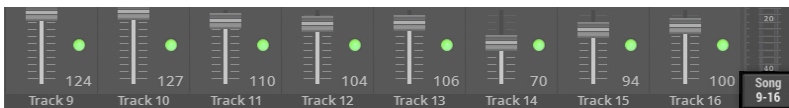
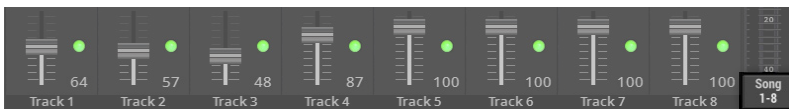
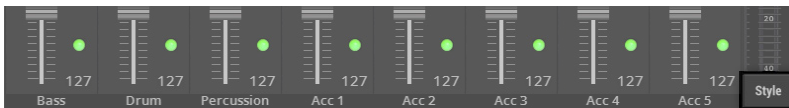
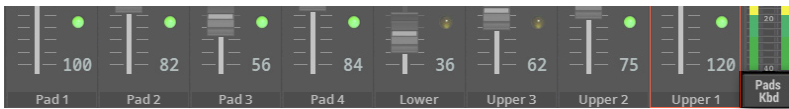

Selecting the track/channel containing the Sound to be edited

- Touch the **individual track/channel** to select it.



D - Save the changes

> When finished editing, save the changes to a Sound combination. It can be a Keyboard Set, a Pad, a Style, a MIDI Song, a SongBook Entry. The following pages will detail how to do.

Saving a Keyboard Set

Keyboard Sets can store the chosen Keyboard Sounds and settings. You can save your Keyboard Sets into the dedicated library, or into the Keyboard Sets inside a User Style.

Saving the Keyboard Sets to the library

The library is where you organize the Keyboard Sets by type and category, independently from a Style or SongBook Entry. You can recall these Keyboard Sets by using the **KEYBOARD SET LIBRARY** buttons, or from the **Home > Main** page.

Factory Keyboard Sets can't be overwritten. If you want to edit and save a Factory Keyboard Set, copy it into the User area.

NOTE: All changes will be lost when choosing a different Keyboard Set, unless you save them.

■ Open the Save dialog from the control panel

1 Switch the **KEYBOARD SET LIBRARY** section to the **CATEGORY** view mode.

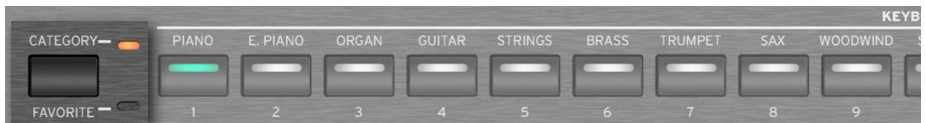

2 Keep **any** of the **KEYBOARD SET LIBRARY** buttons pressed for about one second.

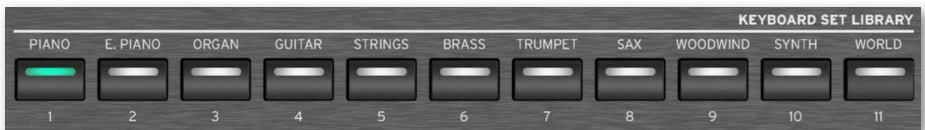

■ **Open the Save dialog from the display**

> Choose the **Save KbdSet (to Library/Style)** command from the **page menu** (☰).

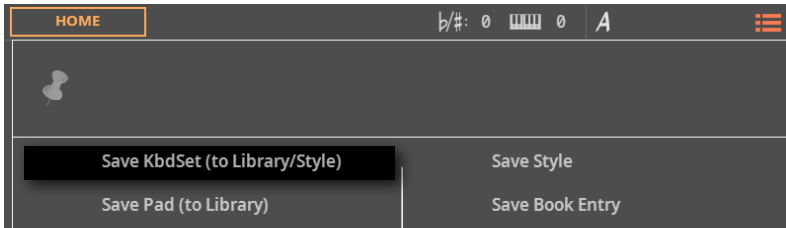

The **Save Keyboard Set** dialog will appear. If the selected Style is a **Factory** one, and you can't save on it, you will only be allowed to save into the **Keyboard Set Library**.

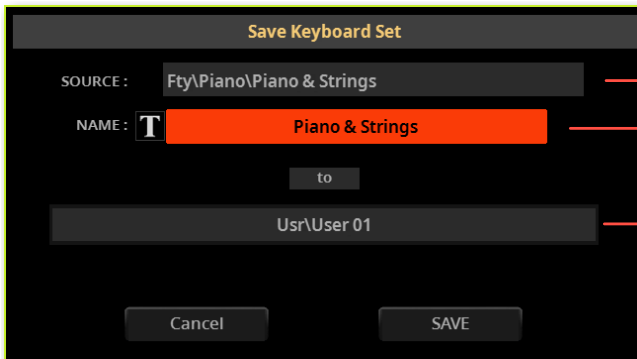

Keyboard Set file path

Keyboard Set name

Touch to open the Select window and choose a target path

If the selected Style is a **User** one, you will be allowed to choose whether to save into one of the **Style's Keyboard Sets** or into the **Keyboard Set Library**.

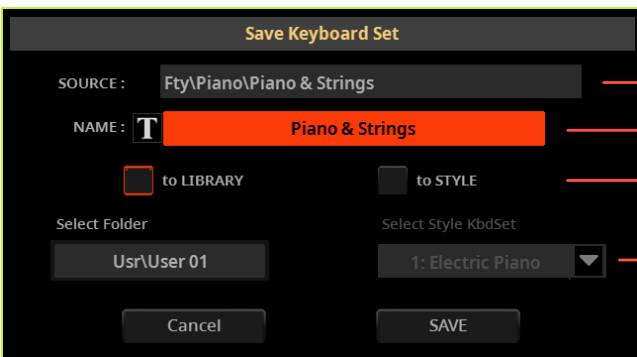

Keyboard Set file path

Keyboard Set name

Library/Style

Touch to open the Select window and choose a target location

■ Save over the same User Keyboard Set

- > If you want to overwrite the current User Keyboard Set, just touch the **Save** button.

■ Rename the Keyboard Set

While in the **Save Keyboard Set** dialog, you may change the **name** of the Keyboard Set.

- 1 Touch the **Text Edit** (**T**) button to open the **virtual keyboard** and edit the name.
- 2 When done editing the name, confirm by touching the **OK** button under the virtual keyboard.

■ Save to a different place

- 1 If you want to save to a different folder, touch the **To (target path)** or **Select Folder** button in the **Save Keyboard Set** dialog, and open the **Save To** window.



2 Touch the **folder** where you want to save the new Keyboard Set.

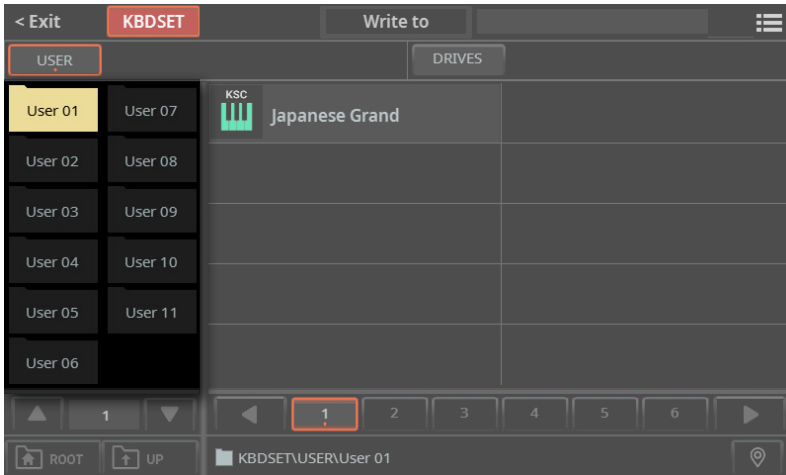

3 To save a new file, don't touch any of the Keyboard Sets in the folder (shown in the right side of the window). On the contrary, if you want to overwrite one of the existing elements, touch it.

4 Press the **EXIT** button to close the **Save To** window and confirm your selection.

5 When back at the **Save Keyboard Set** dialog, confirm the Save operation by touching the **Save** button.

Saving Keyboard Sets into a Style

Styles can contain four Keyboard Sets. When choosing a Style, four Keyboard Sets working well with the selected Style are automatically selected. You can recall these Keyboard Sets by using the **KEYBOARD SET** buttons under the **X-FADER**.

You can save the changes you made to Sound selection, mixing and other settings into a User Style. Factory Styles can't be overwritten. If you want to edit and save a Factory Style, copy it into the User area.

■ Open the Save dialog from the control panel

> Keep any of the **KEYBOARD SET** buttons under the **X-FADER** pressed for about one second.



■ Open the Save dialog from the display

> Choose the **Save KbdSet (to Library/Style)** command from the **page menu** (☰).

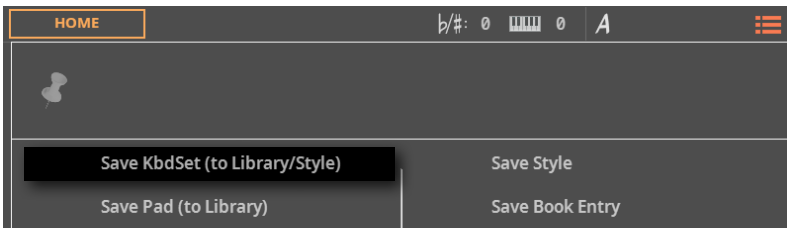

The **Save Keyboard Set** dialog will appear.

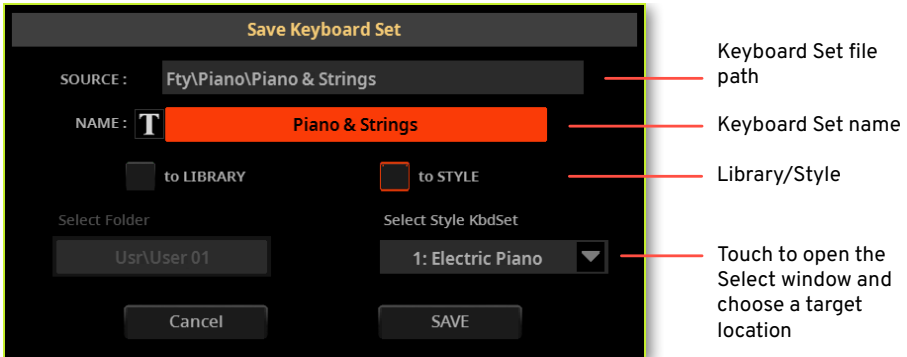

■ Rename the Keyboard Set

While in the **Save Keyboard Set** dialog, you may change the **name** of the Keyboard Set.

- 1 Touch the **Text Edit (T)** button to open the **virtual keyboard** and edit the name.
- 2 When done editing the name, confirm by touching the **OK** button under the virtual keyboard.

■ Save over the Keyboard Set #1

- > Keyboard Set #1 is already selected, so just touch the **Save** button.

■ Save to a different Keyboard Set location

1 If you want to save the Keyboard Set to a different location inside the same Style, touch the arrow next to the **Select Style KbdSet** parameter to open a pop-up menu and choose a different location.

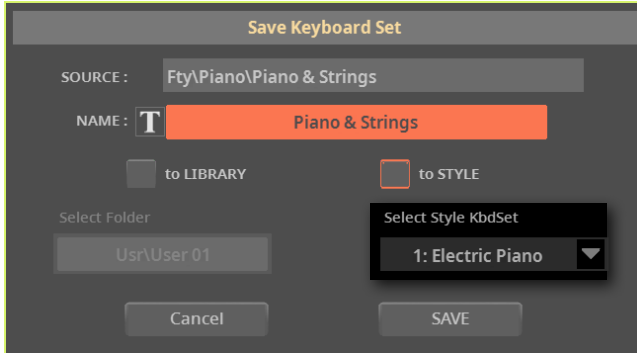

2 Confirm the Save operation by touching the **Save** button.

Saving Keyboard Sets into a SongBook Entry

When choosing a SongBook Entry, four Keyboard Sets matching the selected Entry are automatically selected. You can then recall these Keyboard Sets by using the **KEYBOARD SET** buttons under the **X-FADER**. You can do your changes at these Keyboard Sets as well, and save them in the SongBook Keyboard Sets.

Saving Keyboard Sets to a new SongBook Entry

You can create a new SongBook Entry, and save four Style Keyboard Sets with it. You can later edit the Keyboard Sets saved with the Entry.

- 1 Choose the Style or Song the SongBook Entry will be based on. The Style includes four Keyboard Sets.
- 2 Keep the **BOOK** button pressed for about one second to create a new SongBook Entry. The **Save SongBook Entry** dialog will appear.

As an alternative, go to one of the SongBook pages, and choose the **Save Book Entry** command from the **page menu** (☰).

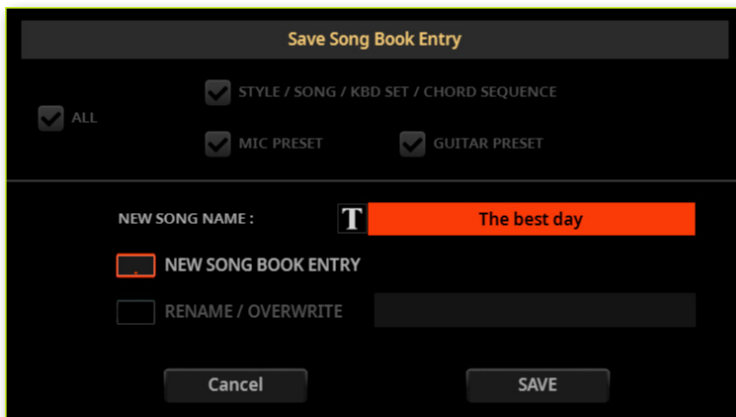

- 3 If both options are offered (because you had selected a SongBook Entry from the list before editing it), decide if you want to create a new Entry (**New SongBook Entry**), or overwrite the selected one (**Rename/Overwrite**).
- 4 While in the **Save SongBook Entry** dialog, touch the **Text Edit (T)** button next to the **New Song Name** parameter, to open the virtual keyboard and edit the name of the Entry.

5 After the virtual keyboard has been closed, touch the **OK** button to save the Entry to the SongBook database.

Together with the Keyboard Sets, the four Style Keyboard Sets have been saved.

Saving the current Style

You can save the changes you made to Sound selection, mixing and other settings into a User Style. Factory Styles can't be overwritten. If you want to edit and save a Factory Style, copy it into the User area.

NOTE: All changes will be lost when choosing a different Style, unless you save them.

- 1 Choose the **Save Style** command from the **page menu** (☰).

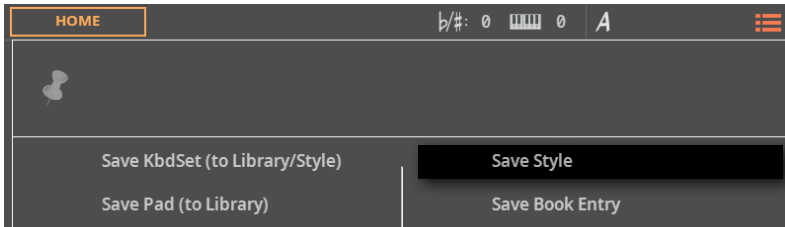

- 2 Confirm saving.

Saving a Pad

You can save the changes you made to EQ, Volume and FX Send into a User Pad. Factory Pads can't be overwritten. If you want to edit and save a Factory Pad, copy it into the User area.

NOTE: All changes will be lost when choosing a different Pad, unless you save them.

- **Open the Save dialog from the display**
- > Choose the **Save Pad (to Library)** command from the **page menu** (☰).

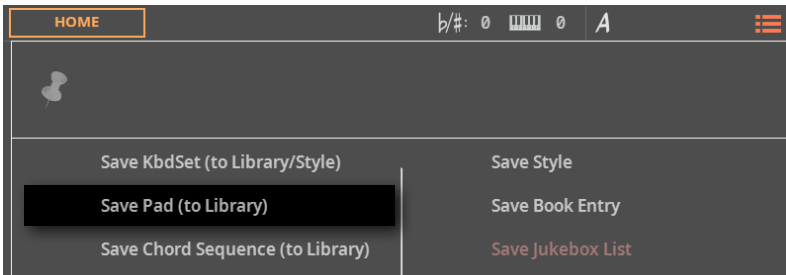

The **Save Pad** dialog will appear.

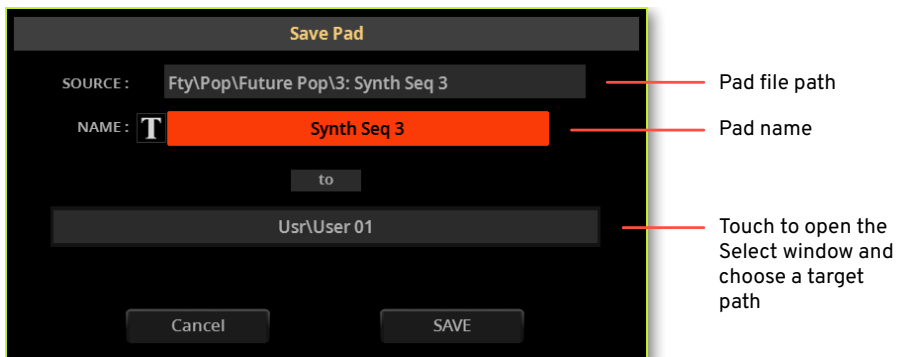

- **Save over the same User Pad**
- > If you want to overwrite the current User Pad, just touch the **Save** button.

■ Rename the Pad

While in the **Save Pad** dialog, you may change the **name** of the Pad.

- 1 Touch the **Text Edit (T)** button to open the **virtual keyboard** and edit the name.
- 2 When done editing the name, confirm by touching the **OK** button under the virtual keyboard.

■ Save to a different place

- 1 If you want to save to a different folder, touch the **To (target path)** button in the **Save Pad** window, and open the **Save To** window.

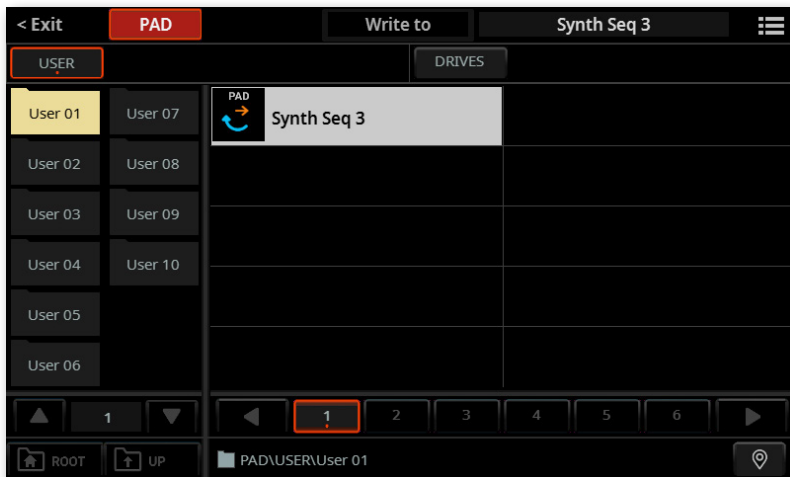

- 2 Touch the **folder** where you want to save the new Pad.

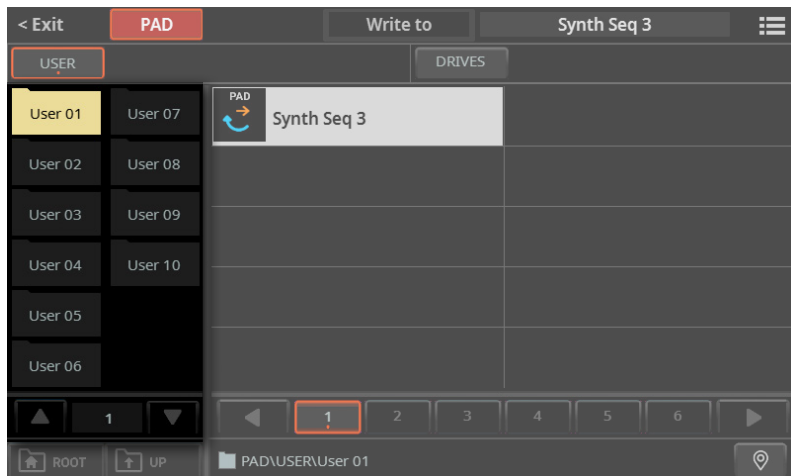

- 3 To save a new file, don't touch any of the Pads in the folder (shown in the right side of the window). On the contrary, if you want to overwrite one of the existing elements, touch it.
- 4 Press the **EXIT** button to close the **Save To** window and confirm your selection.
- 5 When back at the **Save Pad** dialog, confirm the Save operation by touching the **Save** button.

Saving the current MIDI Song

You can save different Sounds into the selected MIDI Song. Please note that any Program Change message contained in the Song can still change the Sounds during playback.

NOTE: All changes will be lost when choosing a different Song, unless you save them.

- 1 Choose the **Save Song** command from the **page menu** (☰).



- 2 Confirm saving.

14

The Mixer

The Mixer

Mixing the Sounds

Mixing from the Home > Control pane

The **Control** pane of the **Home** page contains a selection of mixing controls. Here, you can quickly balance the volume of the Sounds and mute/unmute them.

- > Go to the **Home** page (the one you see when turning the instrument on), and touch the **Control** tab to see the corresponding pane.

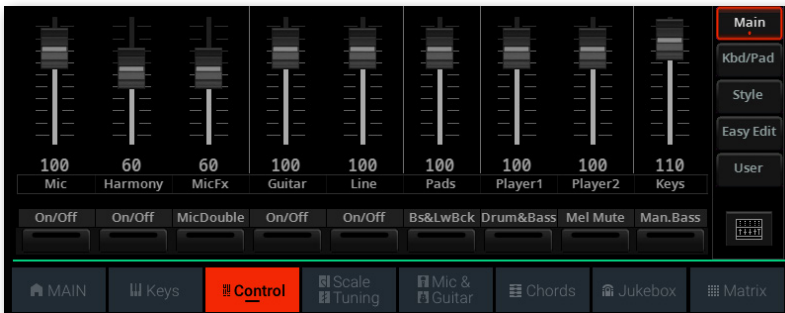

Mixing from the Mixer/FX pages

The **Mixer/FX** edit section is the internal digital mixer of the instrument.

- Go to the **Home > Menu > Mixer/FX** edit section to access the mixing functions. You can also access this section from the **Style/Song Edit > Menu**.

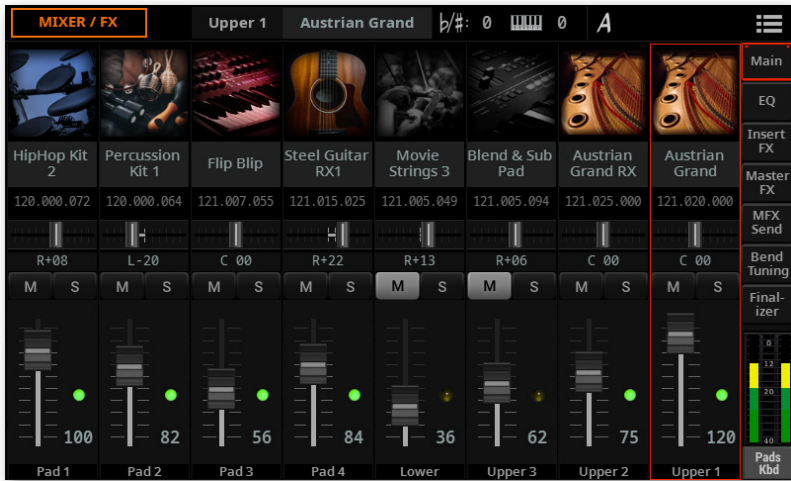

- You can also jump to this page by touching the **Mixer** () button in the **Home > Control** pane.



Checking which Sounds are playing

In the lowest area of various pages, an indicator shows which Sounds are playing.



This lets you see the source of the audio signal. When mixing, you can mute or solo the various channels, and see each Sound's contribution to the overall mix.

Color	Sound
Green	Keyboard or Pad
Orange	Style or Song from Player 1
Blue	Style or Song from Player 2

Metering the audio levels

While in the **Mixer/FX** edit section, a stereo level meter is always visible in the lower right side of the display.



Keep an eye on it while adjusting the volume and EQ levels, or the internal level of the effects. The color of the bars will warn about the risk of overloading and distort the final audio outputs.

Color	Meaning
Green	Audio level is fine.
Yellow	Audio level is fine, but it is running near the maximum. Be careful when increasing the level of the channel volume or an EQ band, or the internal volume of the effects.
Red	The audio output is being overloaded. If this happens occasionally on short peaks (like a percussion hit), it may still be fine. If it remains too long in the red, lower the channel volume, or find the offending EQ band or effect level.

Adjusting the Sounds' Volume and Pan

Adjusting the Volume from the control panel

1 Use the **mode buttons** in the **CONTROL** section to select the groups of Sounds to control. By default, the **MAIN** group is selected, where you can control the audio inputs, the voice effects, and entire groups of Sounds with a single slider. These are the main audio sources of the instrument.



2 If you want to control the individual Sounds of the Style or the MIDI Song, press the **STYLE/SONG** mode button in the **CONTROL** section.



3 Press the **STYLE/SONG** button again to cycle between Song Tracks 1-8 and 9-16.

4 To see which function is assigned to each slider or button, check the **strip display** under the sliders. Press the **VIEW** button on the left to alternate between the sliders and the buttons.

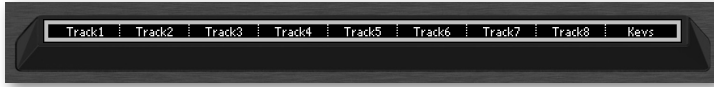

5 Use the **sliders** to adjust the volume.

Volume	Meaning
0...127	Volume level in MIDI values

Adjusting the Volume from the Home page

1 Go to the **Home > Control** pane. By default, the **Main** group is selected, where you can control the audio inputs, the voice effects, and entire groups of Sounds with a single slider.

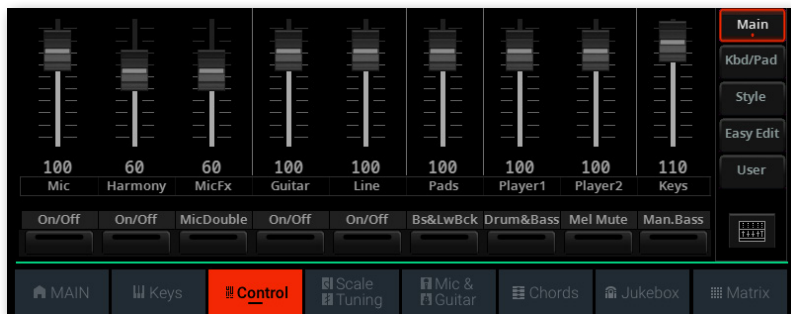

2 If you want to control the individual Sounds of a Style or a MIDI Song, touch the **Style/Song** mode button.

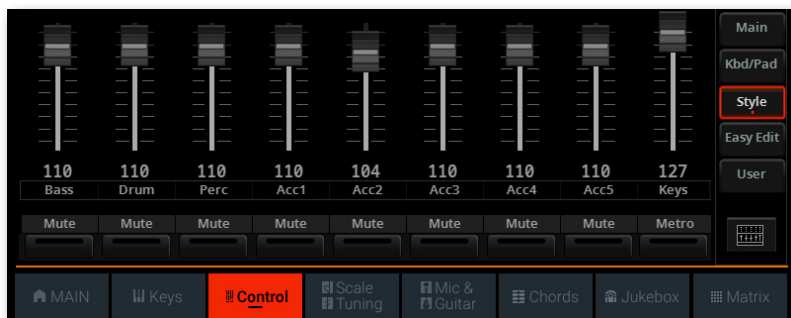

3 If you are editing a MIDI Song, touch the **Song 1-8/9-16** mode button again to cycle between the Song's Tracks 1-8 and 9-16.

- 4 To see which function is assigned to each slider or button, check the **legends** under the sliders.

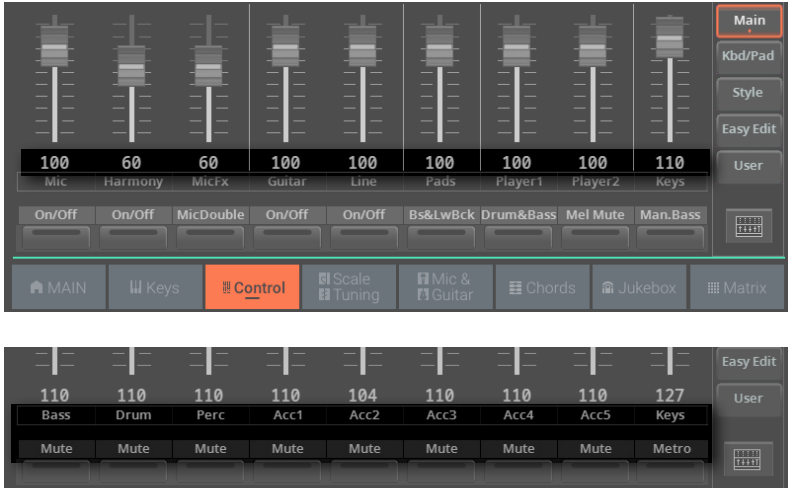

- 5 Use the **virtual sliders** to adjust the volume.

Volume

Meaning

0...127

Volume level in MIDI values

Checking the Volume value

When moving a slider, check the Volume value in the **strip display**, or in the display just **under the slider**. The value in the **strip display** is shown for a short time, before returning to show the slider and button legends.

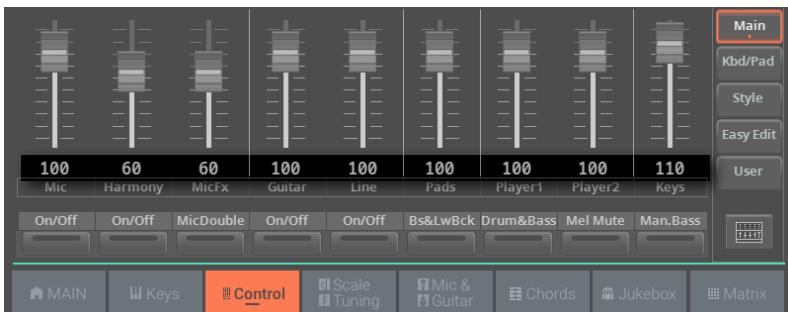

Adjusting Volume and Pan from the Mixer/FX section

1 Go to the **Home > Menu > Mixer/FX > Main** page. You can reach this page by touching the **Mixer** () button in the **Home > Control** pane.

You can also access this section from the **Style/Song Edit > Menu**.



2 Touch the **TRACK SELECT** button to switch between the Sounds of the Keyboard and Pads, and the ones of the Style or the MIDI Song.



3 Use the **vertical sliders** to adjust the Volume.

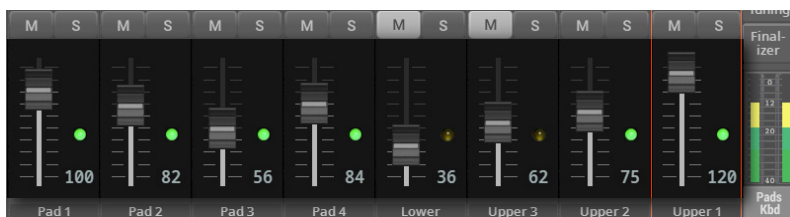

Volume

Meaning

0 .. 127

Volume value from silence to the loudest level

4 Use the **horizontal sliders** to adjust the Pan (short for ‘panorama’, that is the Sound’s position in the stereo field).

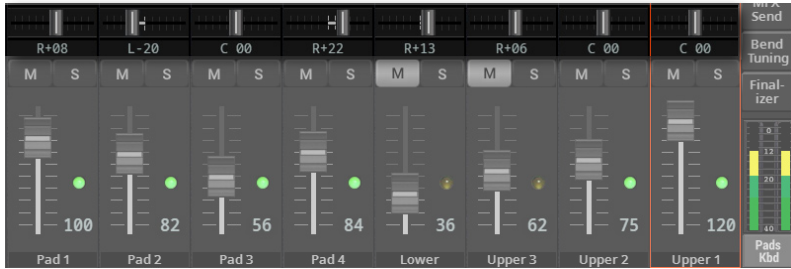

Pan	Meaning
-----	---------

L-64 ... L-1	Left
--------------	------

C 00	Center
------	--------

R+1 ... R+63	Right
--------------	-------

Soloing and muting the Sounds

You can solo or mute the Sounds. **Soloing** can be useful to check how something sounds in isolation. **Muting** can be used to remove a Sound from a mix, either to check the final effect, or to replace it with a live player.

Muting from the control panel

1 Use the **mode buttons** in the **CONTROL** section to select the groups of Sounds to control. By default, the **MAIN** group is selected. Here you can mute the audio inputs and the voice effects, but not the internal Sounds.



2 If you want to mute the Sounds of a Style or a MIDI Song, press the **STYLE/SONG** mode button in the **CONTROL** section.



3 Press the **STYLE/SONG** button again to cycle between Song Tracks 1-8 and 9-16.

- 4 To see which function is assigned to each slider or button, check the **strip display** under the sliders. Press the **VIEW** button to alternate between the sliders and the buttons.



- 5 Use the **buttons** to mute/unmute the corresponding track's Sound.

Muting from the Home page

- 1 Go to the **Home > Control** pane. By default, the **Main** group is selected, and this mode doesn't contain Sound mute controls.

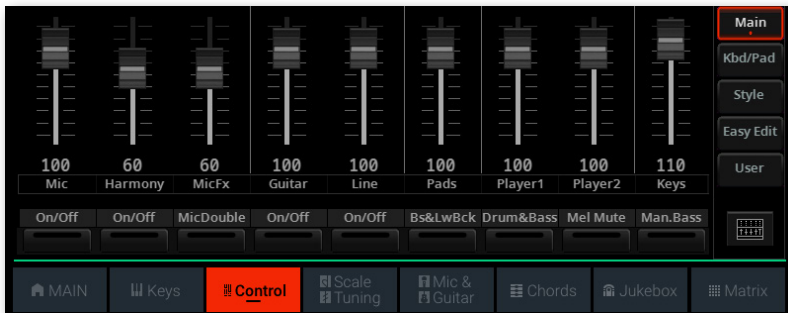

- 2 If you want to control the Sounds of the Style or the MIDI Song, touch the **Style/Song** mode button.



- 3 If you are editing a MIDI Song, touch the **Song 1-8/9-16** mode button again to cycle between the Song's Tracks 1-8 and 9-16.

- 4 To see which function is assigned to each slider or button, check the **legends** under the sliders.



- 5 Use the **virtual buttons** to mute/unmute the corresponding Sound.

Soling and muting from the Mixer/FX section

- 1 Go to the **Home > Menu > Mixer/FX > Main** page. You can reach this page by touching the **Mixer** () button in the **Home > Control** pane.

You can also access this section from the **Style/Song Edit > Menu**.



- 2 Touch the **TRACK SELECT** button to switch between the Sounds of the Keyboard and Pads, and the ones of the Style or the MIDI Song.



- 3 Use the **Mute** (**M**) and **Solo** (**S**) buttons to mute or solo the corresponding Sound.

Viewing and choosing the Sounds

The **Mixer/FX** edit section also allows for choosing Sounds for the Keyboard, Pads, Style and MIDI Songs.

1 Go to the **Home > Menu > Mixer/FX > Main** page. You can reach this page by touching the **Mixer** () button in the **Home > Control** pane.

You can also access this section from the **Style/Song Edit > Menu**.

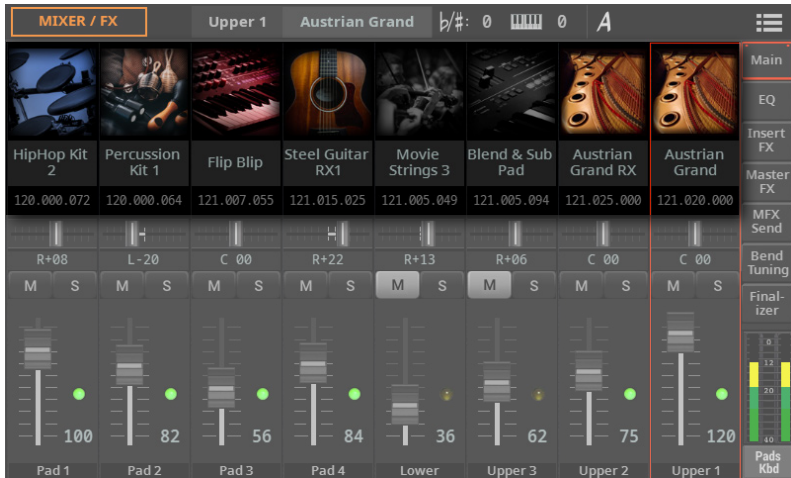

2 Touch the **TRACK SELECT** button to switch between the Sounds of the Keyboard and Pads, and the ones of the Style or the MIDI Song.



3 Touch the **name of the Sound** you want to replace, and choose a different Sound.

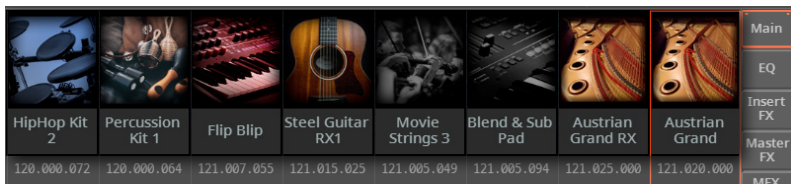

Equalizing the Sounds

Pa5X includes three-band channel equalization (EQ) on each individual mixer channel. Each Sound can be individually equalized.

The equalizer is a powerful tool to shape your sound. Be careful not to overdo, since excessive boost can overload the audio outputs and distort the sound. Sometimes, it is better to attenuate a band instead of boosting it, to make other sounds emerge through the mix.

Adjusting the EQ gain

1 Go to the **Home > Menu > Mixer/FX > EQ** page. You can also access this section from the **Style/Song Edit > Menu**.

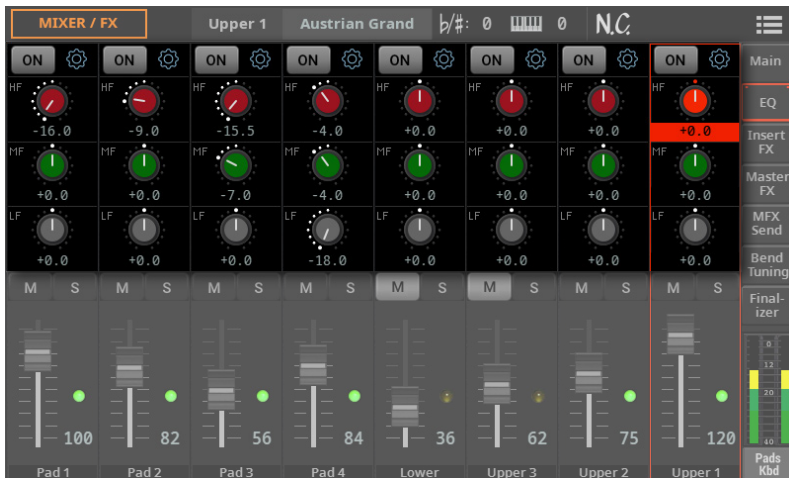

2 Keep the **EQ Gain knob** held on the screen, and move it to the desired level.

As an alternative, use the **DIAL** or **UP/DOWN** controls to change the value of the selected knob.

EQ Gain	Meaning
HF (High Frequency)	
-18 ... +18dB	High frequency equalization. This is a shelving curve filter.
MF (Middle Frequency)	
-18 ... +18dB	Middle frequency equalization. This is a bell curve filter.
LF (Low Frequency)	
-18 ... +18dB	Low frequency equalization. This is a shelving curve filter.

Enabling or disabling the EQ

Each Channel EQ can be turned on or off. This can also be useful to check its effect while editing.

- 1 Go to the **Home > Menu > Mixer/FX > EQ** page. You can also access this section from the **Style/Song Edit > Menu**.



- 2 Use the **On/Off** button on top of the EQ to enable or disable the Channel EQ.

Adjusting the EQ input sensitivity

Extreme equalization gains can overload the audio circuits and lead to distortion. You can, however, trim down the input to avoid overloading.

- 1 Go to the **Home > Menu > Mixer/FX > EQ** page. You can also access this section from the **Style/Song Edit > Menu**.



- 2 Touch the **gear** (⚙️) button to open the **EQ Controls** dialog.

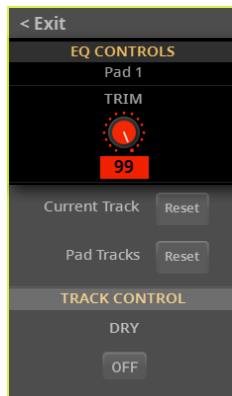

- 3 Use the **Trim** knob to attenuate the level of the signal passing through the equalizer.

Input Trim

Meaning

0 ... 99

Attenuation value

- 4 When done, press the **EXIT** button to close the dialog.

Resetting the EQ

You can reset the EQ to the default (that is, 'flat') status.

- 1 Go to the **Home > Menu > Mixer/FX > EQ** page. You can also access this section from the **Style/Song Edit > Menu**.



- 2 Touch the **gear** (⚙️) button to open the **EQ Controls** dialog.

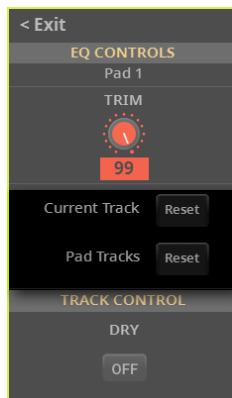

- 3 Reset the current track's EQ, or all the EQs of the group of tracks, as described below.
- 4 When done, press the **EXIT** button to close the dialog.

■ Reset the EQ on the selected track

- > Touch the **Current Track Reset** button.

■ Reset the EQ on a group of tracks

- > Touch the **KbdSet/Pad/Style/Song Tracks Reset** button.

Saving the Mixer settings

You can save the mixer settings into a User Keyboard Set, Pad, Style, a MIDI Song or a SongBook Entry.

- > Choose the **Save Keyboard Set (to Library/Style)** command from the **page menu** (☰) to save the settings to a User Keyboard Set.
- > Choose the **Save Pad** command from the **page menu** (☰) to save the settings to a User Pad.
- > Choose the **Save Style** command from the **page menu** (☰) to save the settings into the current Style. Only User Styles can be overwritten.
- > Choose the **Save Song** command from the **page menu** (☰) to save the settings into the current MIDI Song.
- > Choose the **Save Book Entry** command from the **page menu** (☰) to save the settings into a SongBook Entry.

15

The Effects

The Insert and Master Effects

All the effects of Pa5X

Pa5X includes a powerful multi-effect processor for the internal Sounds. These effects contribute in making the final sound of the instrument, adding vibe and a sense of space. There are up to twenty-three Insert and nine Master Effects, to which the Sounds can be sent from their internal mixer channel.

A separate Finalizer module for each of the Players, with EQ and limiting, takes care of the volume leveling and the sound shaping. The sound coming from a Style or a Song is therefore already perfectly balanced before the final output stage.

The final mastering effects on the audio outputs, making the instrument's sound 'blended' and 'produced', are the result of KORG's long-term cooperation with Waves Audio®, the world reference in studio mastering effects. The included Waves MaxxAudio® suite of effects delivers sound that is louder, clearer, fuller, and more polished.

In addition to the above, Pa5X also includes a multi-effect processor for the microphone and guitar inputs, respectively called the Mic and the Guitar Processor. These incredible effects can be accessed directly from the controls of Pa5X, without having to patch-in any external effect processor.

The FX processors

Pa5X includes Insert and Master Effects ('effect' is often abbreviated as FX).

> **Insert Effects (IFX)** are assigned to a single Sound, and process the whole signal passing through. The most common Insert Effects are amp simulators, chorus, flanger, overdrive and distortion pedals, compressors, etc. Insert Effects are pre-fader, so the volume level of the mixer channel will not change the level of the signal entering the effect.

> **Master Effects (MFX)** are effects shared by several different Sounds, that can be mixed in at different levels (by adjusting the send control). The most common Master Effects are delays and reverbs. Master Effects are post-fader, so the volume level of the mixer channel will change the level of the signal entering the effect.

Each group of Sounds can go to a different group and number of effects.

Sounds	FX Group	Insert FX	Master FX
Keyboard	FX B	Three (3), shared between all the Sounds.	Three (3), common to all the Sounds.
Pad	FX A	-	Three (3), common to all the Sounds.
Player 1	FX A (+B)	Up to ten (10), freely assignable to any Sound. Up to three (3) effects can be assigned to a single Sound.	Three (3), common to all the Sounds. With MIDI Songs, you can also use the ones left unused from Group B.
Player 2	FX A (+B)	Up to ten (10), freely assignable to any Sound. Up to three (3) effects can be assigned to a single Sound.	Three (3), common to all the Sounds. With MIDI Songs, you can also use the ones left unused from Group B.
Drum Families	FX A	Up to seven (7), freely assignable to any Drum Family. Up to two (2) effects can be assigned to a single Drum Family. The individual Drum Families can be processed by their own Insert FXs. The full Drum Kit can then be further processed by its channel Insert FXs.	Three (3), shared between all Sounds. The individual Drum Families have their own send level to the Master FXs. Then, the full Drum Kit has its own general send levels.

You can assign to the Master Effect processors any type of available effects, but we found it convenient to arrange them, most of the times, in the following way:

Master FX	Type of effect
A FX1	Reverb processor for the Pads, Style and MIDI Song Sounds
A FX2	Modulating FX processor for the Pads, Style and MIDI Song Sounds
A FX3	Delay processor for the Pads, Style and MIDI Song Sounds
B FX1	Reverb processor for the Keyboard Sounds
B FX2	Modulating FX processor for the Keyboard Sounds
B FX3	May change

Choosing the FX Group

With the Keyboard, Pad and Style Sounds, the FX Group is fixed and cannot be changed (you can only see it).

With MIDI Songs, you can freely choose between FX Group A and B for each of the Song tracks. Using Group A is usually recommended, to avoid overlapping with the Keyboard Sounds. Also, Group B effects can be changed when choosing a different Keyboard Set, and this would impact on the Song. However, for more advanced programming of MIDI Songs, you are free to use both FX Groups.

1 Go to the **Home > Menu > Mixer/FX > Insert FX** page. You can also access this section from the **Style/Song Edit > Menu**.



Keyboard group shown

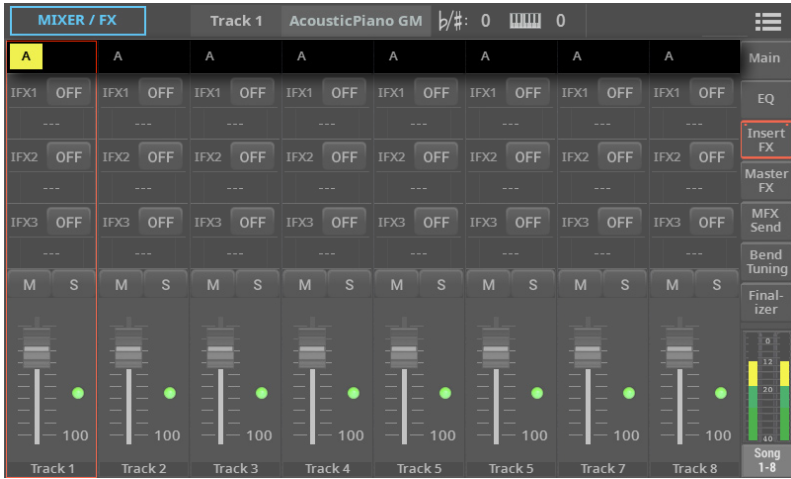

MIDI Song group shown

2 Touch the **TRACK SELECT** button to switch between the Sounds of the Keyboard and Pads, and the ones of the Style or the MIDI Song.

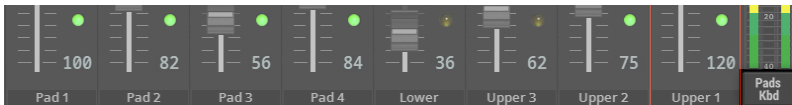

3 If it is allowed, choose an **FX Group** for each of the tracks.

The Insert Effects

Each Sound can go to one or more Insert Effect processors.

Activating the Insert Effects

1 Go to the **Home > Menu > Mixer/FX > Insert FX** page. You can also access this section from the **Style/Song Edit > Menu**.



2 Use the **On/Off** buttons to enable or disable the Insert Effects.

Choosing the Insert Effects

1 Go to the **Home > Menu > Mixer/FX > Insert FX** page. You can also access this section from the **Style/Song Edit > Menu**.



2 Touch the icon of the **effect type** to open the **FX Edit** window.

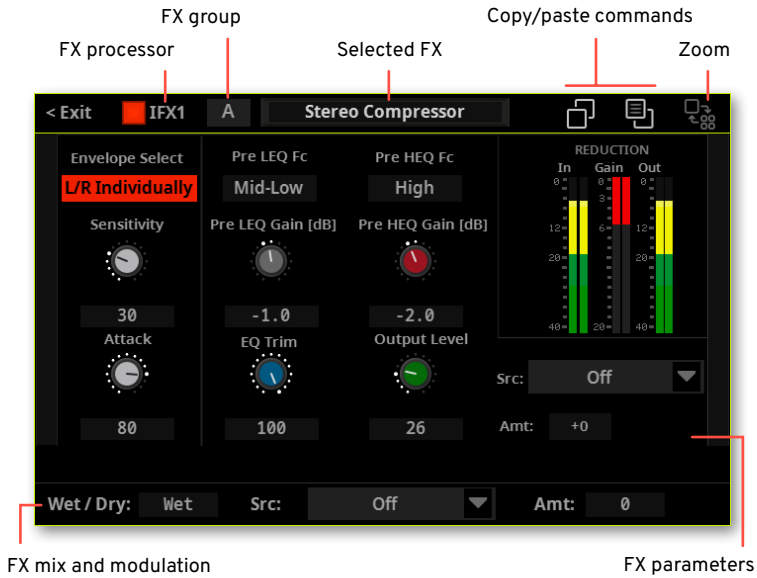

3 Depending on the selected effect, you can touch the **Zoom In** (🔍) button to see the detailed parameters of the effect.

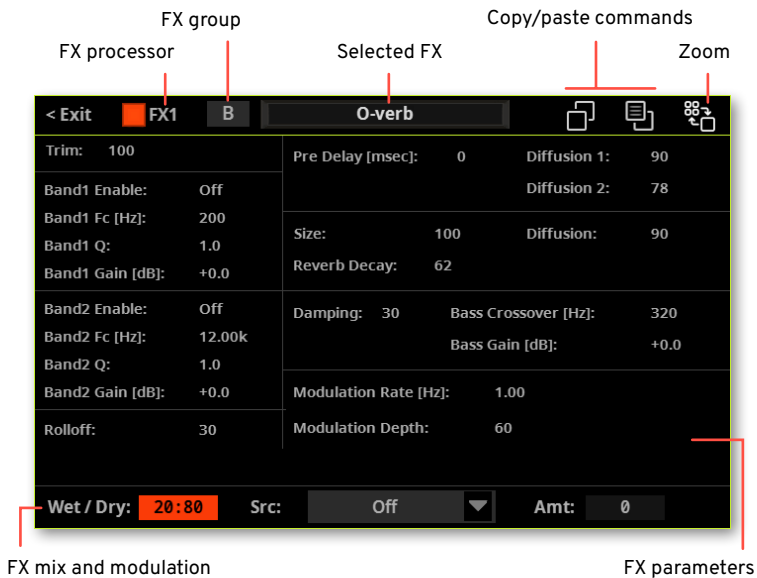

- 4 Touch the **Zoom Out** () button to return to the main parameters of the effect.
- 5 Touch the **name of the selected effect** on top of the dialog to open the **FX Select** window, and choose an effect.
- 6 If needed, edit the various parameters, as described in the part of the User Manual dedicated to the **Effects for the Sounds**.
- 7 You can adjust the **Wet/Dry** mix of the Insert Effects.
- 8 When finished editing, press the **EXIT** button to return to the previous page.

The Insert Effects on the Drum track

On the Drum track, you can access a separate window, and add Insert Effects to each Drum Family. The full Drum Kit is then sent to the Insert Effects of the mixer channel for further processing. This double layer of effects allows for finer shaping of the sound.

- 1 Go to the **Home > Menu > Mixer/FX > Insert FX** page. You can also access this section from the **Style/Song Edit > Menu**.
- 2 Touch the **TRACK SELECT** button to switch between the Sounds of the Keyboard and Pads, and the ones of the Style or the MIDI Song, until you see the Drum track.

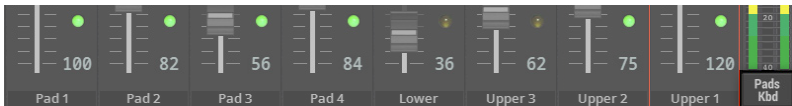

- 3 Locate the Drum track, showing the **Drum Family** button.

Drum Family button

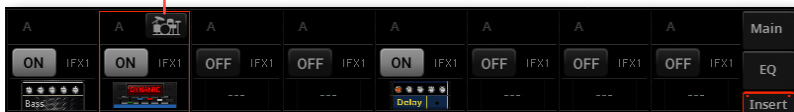

- 4 Touch the **Drum Family** button to access the **Drum Family IFX** window.

IFX 1 and 2 on each Drum Family



Drum Families

- 5 Use the **On/Off** button to enable or disable the Insert Effects.
- 6 Touch the icon of the **effect type** to open the **FX Edit** window.
- 7 When finished editing, press the **EXIT** button to return to the previous page.

The Master Effects

Each Sound can send its audio signal to one or more Master Effects.

Activating the Master Effects

1 Go to the **Home > Menu > Mixer/FX > Master FX** page. You can also access this section from the **Style/Song Edit > Menu**.



2 Use the **On/Off** button to enable or disable the Master Effects.

Please keep in mind that the Master Effects are assigned to all the Sounds of the same group. **FX Group A** is assigned to the Style and MIDI Song Sounds; **FX Group B** is assigned to Keyboard and Pad Sounds (but can also be assigned to selected MIDI Song Sounds).

Choosing the Master Effects

1 Go to the **Home > Menu > Mixer/FX > Master FX** page. You can also access this section from the **Style/Song Edit > Menu**.



2 Touch the icon of the **effect type** to open the **FX Edit** window.

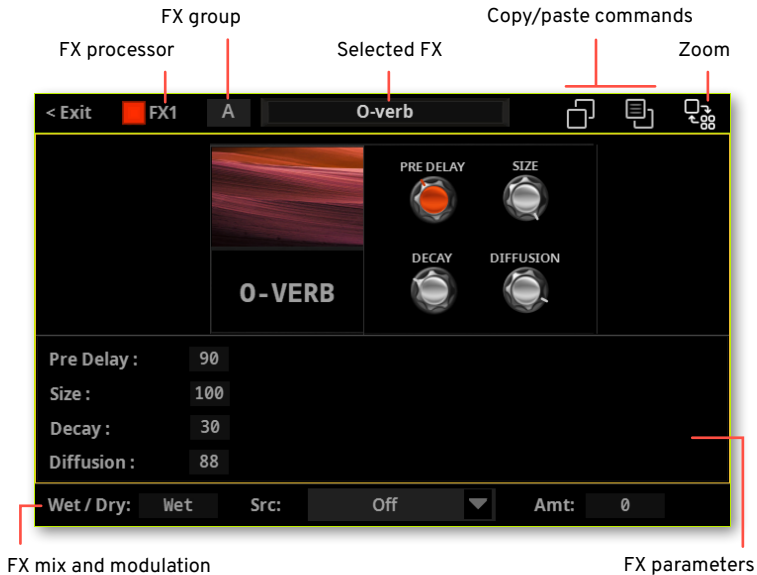

3 Depending on the selected effect, you can touch the **Zoom In** () button to see the detailed parameters of the effect.

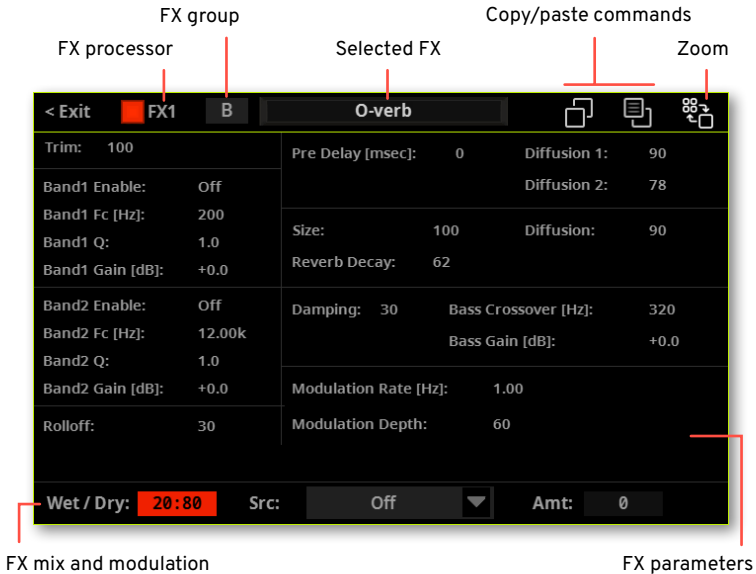

4 Touch the **Zoom Out** () button to return to the main parameters of the effect.

5 Touch the **name of the selected effect** on top of the dialog to open the FX Select window, and choose an effect.

6 If needed, edit the various parameters, as described in the part of the User Manual dedicated to the [Effects for the Sounds](#).

7 You can adjust the **Wet/Dry** mix of the effects. With master effects, it is advisable to leave the mix all Wet, and use the individual mixer channels' send level for mixing the dry and wet signals (as explained below).

8 When finished editing, press the **EXIT** button to return to the previous page.

Checking the effect's resource usage

Pa5X uses high-quality algorithms to generate effects. Some of them may be very heavy on the main processor. Therefore, we added an indicator showing the pressure on the processing resources next to each group of Master Effects.

1 Go to the **Home > Menu > Mixer/FX > Master FX** page. You can also access this section from the **Style/Song Edit > Menu**.



2 Check the resource pressure indicator next to each FX Group.

3 If the resources are starting to get short, or are already overloading, replace the most resource-heavy Insert or Master Effects with nearly equivalent, but lighter ones.

Routing the Master Effects

The Master Effects of each group usually work in parallel. You can, however, set them into a serial chain, with FX2 and FX3 going into FX1.

- 1 Go to the **Home > Menu > Mixer/FX > Master FX** page. You can also access this section from the **Style/Song Edit > Menu**.



- 2 Touch the **Routing** button to open the **Master Effects Routing** window for the corresponding FX Group.



- 3 Use the **FX2** and **FX3** knobs to send their output to the input of **FX1**.
- 4 When finished editing, press the **EXIT** button to return to the previous page.

Adjusting the send level to the Master Effects

You can adjust the level of the direct (dry) signal sent from each Sound to the Master Effects.

1 Go to the **Home > Menu > Mixer/FX > MFX Send** page. You can also access this section from the **Style/Song Edit > Menu**.



2 On each mixer channel, use the **FX** knobs to control the level of the direct (dry) signal sent to the corresponding Master FX processor (inside the selected FX Group, A or B).

Master 1, 2, 3

Meaning

0...127

FX Send level in MIDI values

Adjusting the send level to the Master Effects on Drum-type tracks

On tracks set to Drum mode (usually the Drum and Percussion tracks), you can access a separate mixer, and finely adjust the level of the direct (dry) signal sent from each Drum Family.

The send level of the full Drum or Percussion mixer channel is also adjusted in the main mixer. These are two separate layers of send controls, working together. So, we suggest to lower to zero the Drum and Percussion tracks send level in the main mixer, to avoid overloading the signal on the Master Effects.

- 1 Go to the **Mixer/Tuning > FX Send** page. You can also access this section from the **Style/Song Edit > Menu**.
- 2 Touch the **TRACK SELECT** button to switch between the Sounds of the Keyboard and Pads, and the ones of the Style or the MIDI Song, until you see the Drum and Percussion tracks.



- 3 Locate the Drum track, showing the **Drum Family** button.

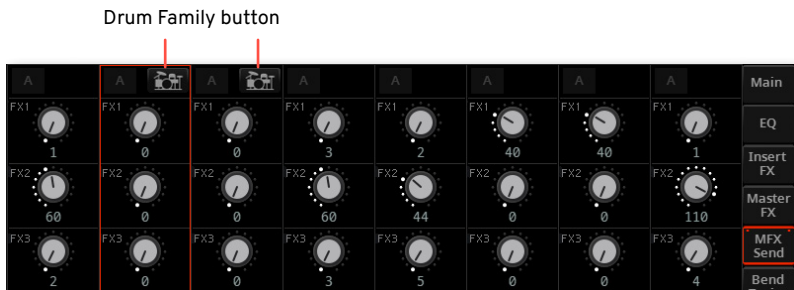

- 4 Touch the **Drum Family** button to access the **Drum Family MFX** window.

MFX 1, 2 and 3 on each Drum Family

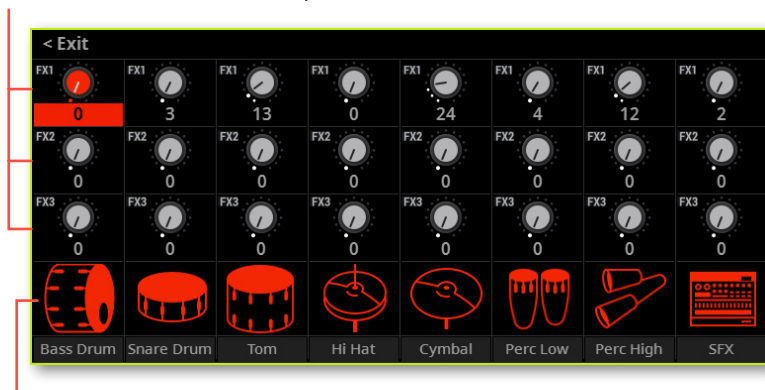

Drum Families

- 5 On each Drum Family strip, use the **FX** knobs to control the level of the direct (dry) signal sent to the corresponding Master FX processor (inside the selected FX Group, A or B).

Master	Meaning
0...127	FX Send level in MIDI values

- 6 When finished editing, press the **EXIT** button to return to the previous page.

Including or excluding the dry (direct) signal in the Master Effects

The dry (or 'direct') signal is the raw sound, without the effects. It should normally be included in the signal coming out from the Master Effects, to give a sense of presence and position of the sound source.

This parameter is not needed for the Insert Effects, since they always include the dry signal.

- 1 Go to the **Home > Menu > Mixer/FX > EQ** page. You can also access this section from the **Style/Song Edit > Menu**.



- 2 Touch the **gear (⚙️)** button to open the **EQ Controls** dialog.

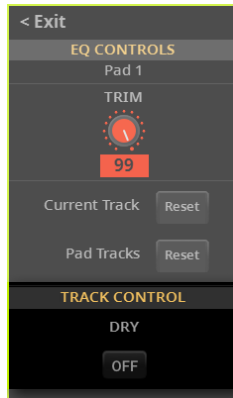

- 3 Use the **On/Off** button to enable or disable the **Dry** signal of the current track.

Dry

Meaning

On The direct signal is sent to the outputs, mixed with the Master Effects.

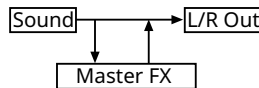

Off

The direct signal is removed from the audio outputs, that will only contain the effected signal. With stereo effects, the effected signal will still be positioned according to the Pan value.

This will work in a way similar to an Insert Effects, where the full dry signal is always processed.

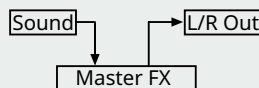

Copying the Insert and Master Effects

To speed up programming, you can copy the individual Insert or Master Effects. You can copy them between different elements (for example, between Styles and Song, or Keyboard Sets and Sounds).

The Copy/Paste operation only copies the parameters contained in the **FX Edit** window.

The **Copy/Paste** commands are contained in the **FX Edit** window itself.



■ Copy the effect

- 1 Select the **source element** (Keyboard Set, Style, Song or Sound).
- 2 Go to the **Mixer/Tuning > Insert FX** page to copy an Insert Effects, or to the **Master FX** page to copy a Master Effects.
- 3 Touch the **name of the effect** to be copied, to open the corresponding **FX Edit** window.
- 4 Touch the **Copy Effect** () button.
- 5 Press the **EXIT** button to exit.

■ Paste the effect

- 1 Select the **target element** (Keyboard Set, Style, Song or Sound).
- 2 Go to the **Mixer/Tuning > Insert FX** page to paste an Insert Effects, or to the **Master FX** page to paste a Master Effects.
- 3 Touch the **name of the effect** to be pasted, to open the corresponding **FX Edit** window.
- 4 Choose the **Paste Effect** () button.
- 5 Press the **EXIT** button to exit.

Saving the Insert and Master Effects settings

You can save the Insert and Master Effects settings into a User Keyboard Set, Pad, Style, a MIDI Song or a SongBook Entry.

- > Choose the **Save Keyboard Set (to Library/Style)** command from the **page menu** (☰) to save the settings to a User Keyboard Set.
- > Choose the **Save Pad** command from the **page menu** (☰) to save the settings to a User Pad.
- > Choose the **Save Style** command from the **page menu** (☰) to save the settings into the current Style. Only User Styles can be overwritten.
- > Choose the **Save Song** command from the **page menu** (☰) to save the settings into the current MIDI Song.
- > Choose the **Save Book Entry** command from the **page menu** (☰) to save the settings into a SongBook Entry.

The Finalizer

Accessing the Finalizer

The Finalizer gives to the sound of a song a clear and punchy finish, before being sent to the mastering effects on the audio outputs. It also warrant a balanced level between all the Styles and Songs you will play.

There is a Finalizer for each of the Players. The Pads are processed according to the selected Player. Keyboard Sounds are not affected by the Finalizer. The settings are saved into each Style or SongBook Entry.

The included effects are a four-band parametric equalizer and a limiter. These are studio-grade mastering effects, with a pleasant, warm analog sound, comparable to the best 'outboard' effects found in professional recording studios.

> Go to the **Home > Menu > Mixer/FX > Finalizer** page. You can also access this section from the **Style/Song Edit > Menu**.



Editing the Equalizer

Standard and expanded view

You can edit the main parameters of the equalizer from the main page.

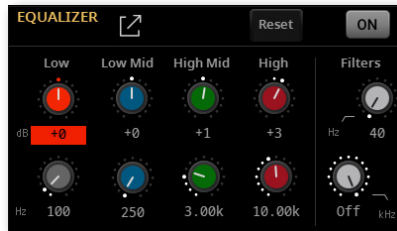

However, you can touch the **Expand** (↗) button to access more parameters.

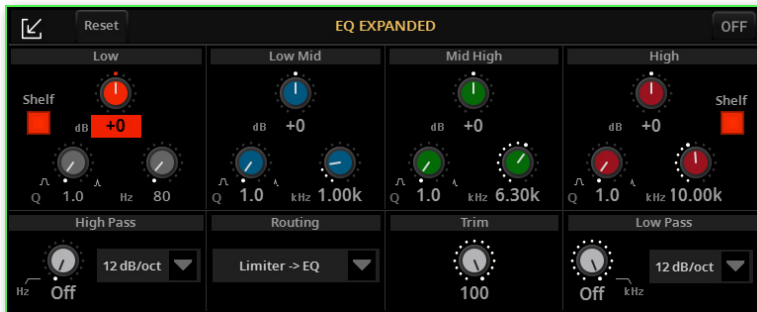

After having edited the parameters, you can go back to the reduced size by touching the **Collapse** (↙) button.

Shelving- or bell-type EQ curves

The **Shelf** button in the Low and High bands is usually enabled, making them low- or high-shelving EQ curves. You can disable it to make them bell/peaking-type EQ curves.



A **Low Shelf EQ** allows for attenuating or boosting the level of the frequency range below the selected frequency. A **High Shelf EQ** allows for attenuating or boosting the level of the frequency range above the selected frequency.

A **Bell/Peaking EQ** allows for cutting or boosting the level of the frequency range around the selected center frequency.

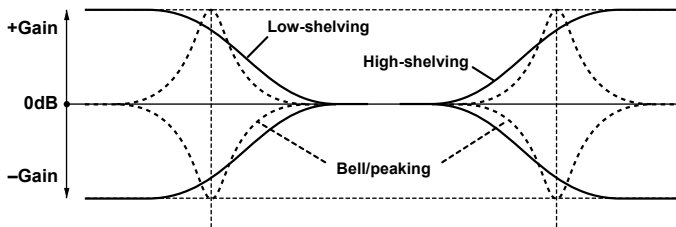

Setting the EQ

Use the **EQ** section to shape the sound.

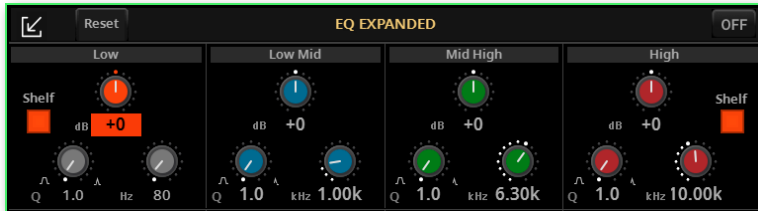

- > Use the **dB** knob to set each EQ band's gain.

dB (Gain)	Meaning	Value
All bands	Cuts or boost the selected EQ band.	-18 ... +18 dB

- > Use the **Q** knob to set each EQ band's 'quality factor' or width.

Q (Width)	Meaning	Value
All bands	Quality factor, or bandwidth. Higher values make the band narrower, therefore the EQ more precise and focused on a single frequency. Lower values make the band larger, 'coloring' a wider range or frequencies.	1 ... 10

- > Use the **Hz** knob to set the center frequency.

Hz (Frequency)	Meaning	Value
Low	Center frequency of the EQ band.	20 Hz ... 1.00 kHz
Low Mid		50 Hz ... 5.00 kHz
Mid High		300 Hz ... 10.00 kHz
High		500 Hz ... 20.00 kHz

Setting the High Pass and Low Pass filters

In addition to the EQ bands, you can set an high-pass and a low-pass filter.

A **High-Pass Filter** cuts out the lower frequencies, letting you remove any rumble or excessive bass that may result from adding many instruments in the lower range.

A **Low-Pass Filter** cuts out the higher frequencies, making the sound somewhat 'softer'. It may also be used to remove any hiss or piercing sound that may be in some samples (like the sound of the violin bow on the strings, or a guitar's feedback), or that may be emphasized when using effects boosting the higher range.



Filter	Meaning	Value
Hz (High-Pass)	Frequency from which the filter starts to cut the sound.	Off, 20Hz ... 1.00kHz
Hz (Low-Pass)		500Hz ... 20.00kHz, Off
dB/octave	The intensity of the filter depends on the attenuation per octave, or 'slope'. With 6 dB/octave, intensity is halved in the octave above the selected frequency. With 12 dB/octave it is reduced four times, and so on.	6 ... 24 dB/octave

Internal routing of the signal

You can choose if the Limiter or the EQ comes first in the Finalizer's effect chain. You can put the Limiter first to tame any signal peak, and then add high-frequency 'shimmer' back to the signal with the EQ. Or you can put the EQ first to cut uneven frequencies, and then let the Limiter smooth out the resulting sound.



Trimming the output gain

Use the **Trim** control to adjust the EQ's output gain. The Finalizer's output goes to the Mastering effects, and too loud a signal may overload their input.



Resetting the EQ parameters

You can reset the EQ parameters by touching the **Reset** button.

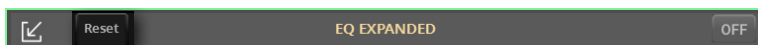

Editing the Limiter

The Limiter

This parametric limiter allows for taming the volume peaks, giving an overall impression of ‘glue’ and ‘blend’ to the sound coming from the Player.



Check if the **In** indicator is going into the red. If it is, the signal before the Limiter is too high. If the EQ comes before the Limiter, try reducing the EQ's **Trim** control. If the Limiter comes first, check the signal chain before the Finalizer to see at which stage the signal is too ‘hot’.

While adjusting the Limiter's parameters, check the **Out** indicator to see if the signal going out of the Limiter is clipping (red). If it is, reducing the **Gain** can solve the issue.

The **Gain Reduction (GR)** indicator shows the amount of limiting going on. Usually, just a hint of limiting may make the signal smoother, without reducing the overall naturalness of the sound. But you may want to limit more aggressively for special effects, and you can do so by lowering the **Threshold** level.

Limiters	Meaning	Value
Ratio	This is the amount of reduction operated by the limiter once the Threshold level has been reached. For example, '2:1' means that the level is halved.	1.0:1 ... 50.0:1, Inf:1
Threshold (dB)	This is the level over which the limiter will start compressing the signal. Lower values mean that the limiter will start working more often.	-40 ... 0 dB
Attack	This is the speed at which the limiter starts operating when the Threshold level is exceeded. Too fast an attack might cut the sound's initial transients. Too slow, it can let 'bursts' of signal pass.	1 ... 100 ms
Release	This is the speed at which the limiter ends operating after the signal is returned again below the Threshold level. Too fast the release might cut the sound's tail, and the sudden release may cause 'pumping'. In EDM music, this may be a desired effect. On the other side, a longer release time may affect parts of the audio that should remain unaffected, for example low-level sounds like reverb tails or mechanical noises.	1 ... 100 ms
Gain Adjust (dB)	Limiting may cause loss of overall volume level, so you may want to 'make-up' the output level with this control.	-Inf, -38 ... +24

Saving the Finalizer settings

You can save the Finalizer settings into a User Style, a MIDI Song, a SongBook Entry.

- > Choose the **Save Style** command from the **page menu** (☰) to save the settings into the current Style. Only User Styles can be overwritten.
- > Choose the **Save Song** command from the **page menu** (☰) to save the settings into the current MIDI Song.
- > Choose the **Save Book Entry** command from the **page menu** (☰) to save the settings into a SongBook Entry.

16

The Track parameters

Tuning

Transpose

You can transpose each Sound by one or more semitones. This can be used, for example, to transpose a Sound when playing with the split keyboard, or to double a Sound by the octave.

- 1 Go to the **Home > Menu > Mixer/FX > Bend/Tuning** page.
- 2 Use the **b/#** knobs to set the semitone transposition for each Sound.



Transpose

Meaning

0

Standard tuning.

-36 ... +36

Transpose value (in semitones). Twelve semitones = one octave.

Fine tuning

You can fine-tune each Sound. This can be useful to create a sense of realism and depth, replicating the slight lack of tuning precision typical of a real performer.

- 1 Go to the **Home > Menu > Mixer/FX > Bend/Tuning** page.
- 2 Use the **Detune** knobs to set the fine tuning for each Sound.

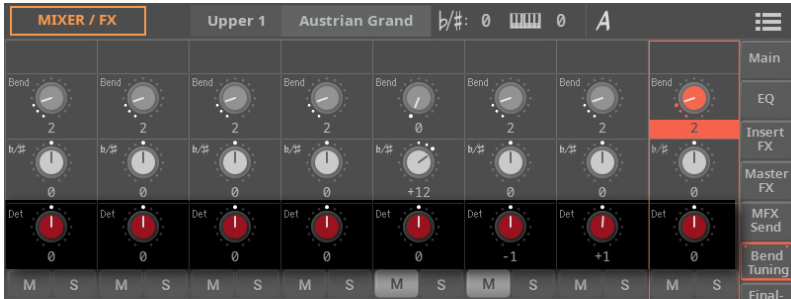

Detune

Meaning

0

Standard tuning.

-64 ... +63

Sound pitch (in cents of a semitone).

Routing and polyphony

Using the internal or external Sounds

Usually, Pa5X plays the Sounds generated by the internal sound engine. However, you can choose to let it play the sounds of an external device (a sound module, a virtual instrument running on a personal computer).

- 1 Go to the **Home > Menu > Track Control > Mode** page.



- 2 Use the **Internal/External** parameter to connect the corresponding track to the internal and/or external sound generation.

Int/Ext	Meaning
Both	The track plays both the internal sounds and an external instrument connected to the MIDI OUT or USB DEVICE port.
Internal	The track only plays the sounds generated by the internal sound generator.

Int/Ext**Meaning**

External

The track only plays an external instrument connected to the MIDI OUT or USB DEVICE port. The connected device must receive data on the MIDI channel associated with this track on Pa5X.

Pa5X can select sounds on the external device; the Program Change bundle is shown in the Home > Menu > Mixer/FX > Main page.

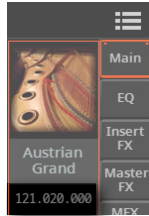

None

The track is not connected to the internal sound generator, nor to an external one.

Choosing the polyphony mode

Sounds can play polyphonically or monophonically, or behave as Drum Kits.

- 1 Go to the **Home > Menu > Track Control > Mode** page.



- 2 Use the **Type** parameter to choose the polyphony mode.

Type	Meaning
Drum	Drum/Percussion track. This is typically assigned to the Drum and Percussion tracks of the Styles and MIDI Songs. Set a Keyboard Sound to Drum mode, if you don't want it to be transposed (it will behave as a Drum Kit, even if it is an ordinary Sound). Also, set it to Drum mode if you wish to separately adjust the volume and set a different output for each percussive family of a Drum Kit. Drum Kits are never transposed, whichever the type of track they are assigned to. This parameter cannot be edited, if the track has already been set to Drum or Percussion mode in Style Edit mode.
Poly	Tracks of this type are polyphonic, meaning they can play more than one note at the same time.
Mono	Tracks of this type are monophonic, meaning each new note stops the previous note.
Mono Right	A Mono track, with priority assigned to the rightmost (highest) note.
Mono Left	A Mono track, with priority assigned to the leftmost (lowest) note.

Quick editing of Sounds and Drum Kits

Quick editing of Sounds

You can edit the main parameters of a Sound. These changes are offset to the original values. They will be saved to a Sound combination (User Keyboard Set, User Style, SongBook, etc.), and not directly into a Sound. For deeper editing, please access Sound Edit.

Editing the Sounds

- 1 Go to the **Home > Menu > Track Controls > Sound Edit** page.
- 2 Select the track containing the Sound to be edited.



- 3 If you like, start the Style or Song to listen to the changes during playback.
- 4 Use the **Mute (M)** and **Solo (S)** buttons to mute or solo the track you are editing, to isolate it from the other tracks.

5 Use the **knobs** to edit the corresponding parameters. All the values are offsets referred to the value of the original Sound.

Sound parameter	Meaning	Value
Attack	Attack time. This is the time during which the sound goes from zero (at the moment when you strike a key) to its maximum level.	
Decay	Decay time. Time to go from the final Attack level to the minimum level.	
Release	Release time. This is the time during which the sound goes from the sustaining phase, to zero. The Release is triggered by releasing a key.	-64 ... +63 (offset)
Cutoff	Filter cutoff. This sets the sound brightness.	
Resonance	Use the Filter Resonance to boost the cutoff frequency.	
LFO Depth	Intensity of the Vibrato (LFO).	
LFO Speed	Speed of the Vibrato (LFO).	
LFO Delay	Delay time before the Vibrato (LFO) begins, after the sound starts.	

Setting Portamento

Portamento is a smooth sliding transition from a note to the following one.

- > Select the **Portamento > On** checkbox to turn portamento on, or uncheck it to turn it off.
- > Use the **Portamento > Time** knob to adjust the speed of portamento.

Resetting the parameters

■ Reset a track

- > Touch the **Reset Current Track** button to reset all changes to the selected track.

■ Reset all tracks

- > Touch the **Reset Keyboard Set Tracks** or **Reset Style Tracks** button to reset all edited values in all the corresponding tracks.

Quick editing of Drum Kits

You can edit the main parameters or a Drum or Percussion Kit. These changes are offset to the original values. They will be saved to a Sound combination (User Keyboard Set, User Style, SongBook Entry, etc.), and not directly into a Drum or Percussion Kit. For deeper editing, please enter Sound Edit.

In this page, you can adjust the volume and edit the main parameters for each family of Drum and Percussion instrument for the selected track. A list of families is shown below.

These parameters can be accessed only on tracks set to the Drum mode in the **Track Controls > Mode** page. Use them on tracks with a Drum Kit assigned, or you will not be able to hear any change.

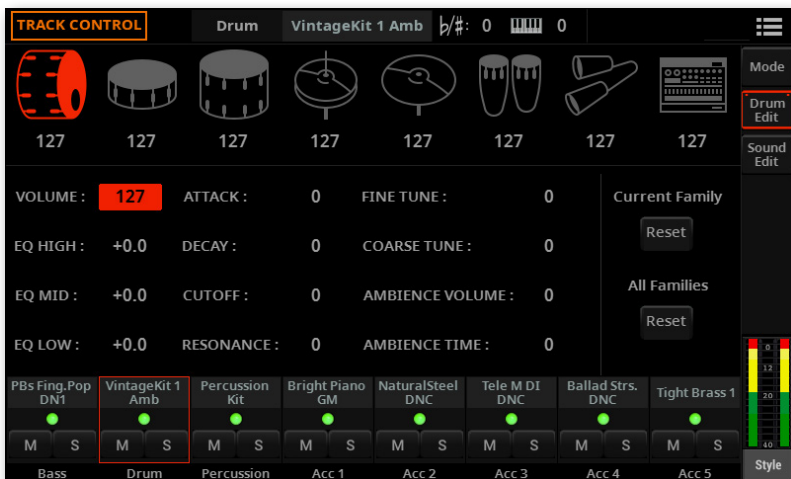

Editing the Drum Kits

- 1 Go to the **Home > Menu > Track Controls > Drum Edit** page. You can also access this section from the **Style Edit > Menu**.
- 2 Select a track set to the Drum mode (usually the **Drum** or **Percussion** track). The **Drum Family** icons on top of the page can now be selected.



- 3 If you like, start the Style or MIDI Song to listen to the changes during playback.
- 4 Use the **Mute** (**M**) and **Solo** (**S**) buttons to mute or solo the track you are editing, to isolate it from the other tracks.

5 Select one of the Drum **Family** icons on top of the page.

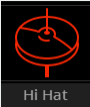
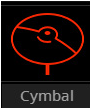
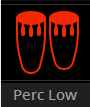
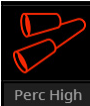
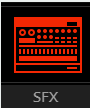
Drum Family icon	Drum family
 Bass Drum	Kick drums
 Snare Drum	Snare drums
 Tom	Toms
 Hi Hat	Hi-Hat cymbals
 Cymbal	Ride, Crash and other cymbals
 Perc Low	Low-pitched percussions
 Perc High	High-pitched percussions
 SFX	Special effects

6 Check the value of the selected parameter for all the Drum families. An overview of the current parameter can be seen under the icons of the Drum Families.

This will let you compare the value of the selected family with all the others. The values appear dimmed (non-editable).



7 Select and edit the parameters. Most of the values are offsets referred to the value of the original Drum Kit.

DK parameter	Meaning	Value
Volume	Instrument's family volume.	0 ... 127
EQ Hi	Equalization, High band.	-18 ... +18
EQ Mid	Equalization, Middle band.	
EQ Low	Equalization, Low band.	
Attack	Attack time. This is the time during which the sound goes from zero (at the moment when you strike a key) to it's maximum level.	
Decay	Decay time. Time to go from the final Attack level to the minimum level.	
Cutoff	Filter cutoff. This sets the sound brightness.	-64 ... +63 (offset)
Resonance	Use the Filter Resonance to boost the cutoff frequency.	
Fine Tune	Fine instrument tuning.	
Coarse Tune	Coarse instrument tuning.	
Ambience Volume	Volume of the Ambience effects (environment and mechanical noise).	
Ambience Time	Length of the Ambience effects (environment and mechanical noise).	

Resetting the parameters

■ Reset a Drum family

> Touch the **Reset Current Family** button to reset all edited values.

■ Resetting a track

> Touch the **Reset All Families** button to reset all changes to the selected track.

Setting the key and velocity range

You can program a key and velocity zone for each of the Keyboard Sounds. These can create separate zones for different Sounds.

Setting the Key Range

Key range is useful to create a set of Keyboard Sounds playing in different zones of the keyboard. For example, you may have French Horns and Woodwinds playing in the center range of the keyboard, while only Woodwinds play on the higher range.

- 1 Go to the **Home > Menu > Keyboard/Ensemble > Range/Velocity** page.
- 2 Select the Keyboard Sound to be edited.

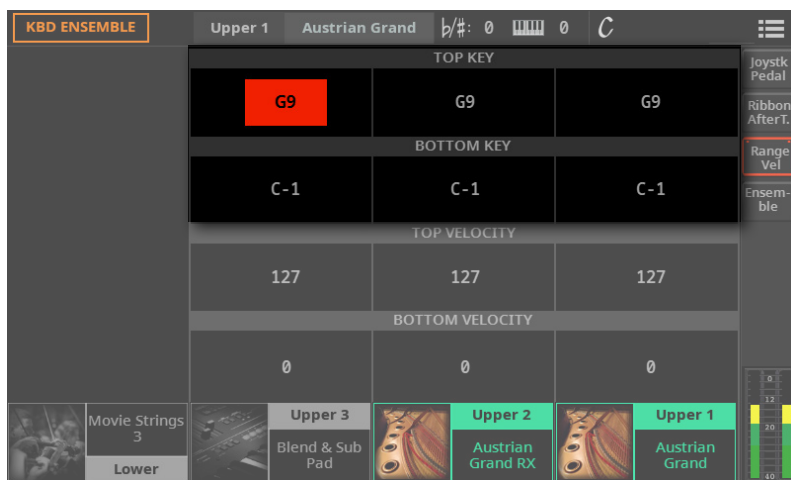

- 3 Use the **Top Key** and **Bottom Key** parameters to set the Top and Bottom limits of the Sound's Key zone.

Key

C-1 ... G9

Meaning

Selected key. The Top value is always higher than the Bottom value.

Setting the Velocity Range

Velocity range is useful to create a sound made of up to three dynamic layers, assigning each of the Upper Sounds to a different velocity zone. As an example, you may choose **MK II Suitcase** as the Upper 1 Sound, and **MK I Dyno** as the Upper 2 Sound. Then, set Upper 1 to Bottom=0, Top=80, and Upper 2 to Bottom=81, Top=127. The **MK II Suitcase** will play when playing softer, the **MK I Dyno** when playing louder.

- 1 Go to the **Home > Menu > Keyboard/Ensemble > Range/Velocity** page.
- 2 Select the Keyboard Sound to be edited.

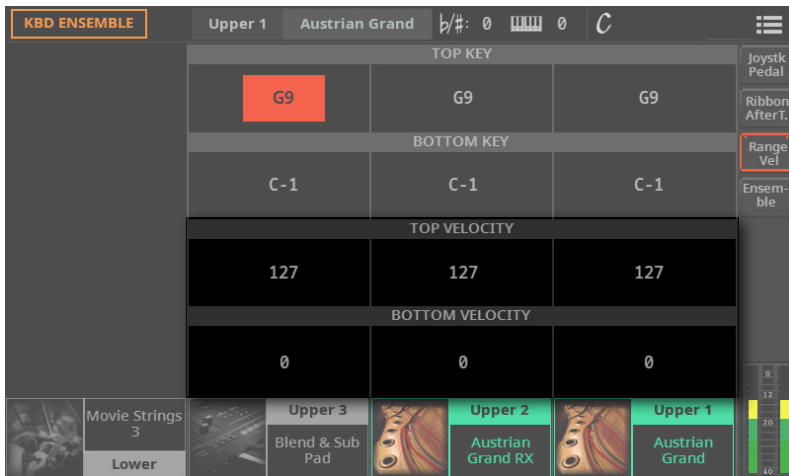

- > Use the **Top Velocity** and **Bottom Velocity** parameters to set the Top and Bottom limits of the Sound's Velocity zone.

Velocity

Meaning

0 ... 127

Velocity value. The Top value is always higher than the Bottom value.

Saving the Track settings

You can save the Track settings into a User Keyboard Set, Pad, Style, a MIDI Song or a SongBook Entry.

- > Choose the **Save Keyboard Set (to Library/Style)** command from the **page menu** (☰) to save the settings to a User Keyboard Set.
- > Choose the **Save Pad** command from the **page menu** (☰) to save the settings to a User Pad.
- > Choose the **Save Style** command from the **page menu** (☰) to save the settings into the current Style. Only User Styles can be overwritten.
- > Choose the **Save Song** command from the **page menu** (☰) to save the settings into the current MIDI Song.
- > Choose the **Save Book Entry** command from the **page menu** (☰) to save the settings into a SongBook Entry.

17

Digital Drawbars

The Digital Drawbars

What are the Digital Drawbars?

Digital Drawbars are special Sounds emulating the classic tonewheel organs. Settings for the Digital Drawbars are memorized in a Keyboard Set, a Style or a MIDI Song, and may be considered the equivalent of an organ's preset.

A single Digital Drawbars Sound can be assigned to the keyboard, and only one to the Style. A single Digital Drawbars Sound can be assigned to Tracks 1-8, and a single one to Tracks 9-16 or a MIDI Song.

You can assign the same Sound to different tracks in the same block (for example, two different Accompaniment tracks in a Style). On the contrary, if you need the different manuals of an organ, you can assign each of them to a different block (for example, the Upper manual to one of the Tracks 1-8, and the Lower manual to one of the Tracks 9-16).

Choosing Digital Drawbars Sounds

By choosing a Keyboard Set

- 1 Open the **Keyboard Set Select** window.
- 2 Open the **Organ** category, and choose a Keyboard Set whose name begins with the 'DWB' (Drawbars) abbreviation.



By choosing a Sound

- 1 Open the **Sound Select** window.
- 2 Open the **Organ** category, and choose the **DRAWBARS** Sound.



When choosing a Digital Drawbars Sound alone, we suggest to check the **Use IFX** option in the **page menu** (☰) of the **Sound Select** window. This will force selection of the effects included with the Sound (for the DRAWBARS, they are Organ Vibrato, CX-3 Amp e CX-3 Rotary Speaker).

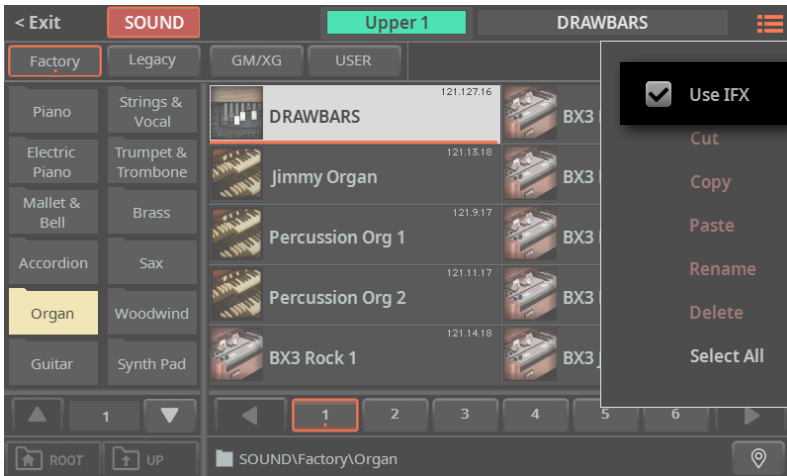

Controlling the Digital Drawbars

Controlling the drawbars from the control panel

- 1 Select a **Digital Drawbars Sound**, or a Keyboard Set marked as **DWB**.
- 2 Press the **EASY EDIT/DWB** button in the **CONTROL** section of the control panel to select the **Drawbars (DWB)** mode.



- 3 To see which function is assigned to each slider or button, check the **strip display** under the sliders. Press the **VIEW** button to alternate between the sliders and the buttons.



- 4 Use the sliders and the buttons to change the drawbars registration and enable or disable the various features.

Controlling the drawbars from the display

- 1 Select a **Digital Drawbars** Sound, or a Keyboard Set marked as **DWB**.
- 2 Go to the **Home > Control** pane, and select the **Drawbars** mode from the side tabs.



- 3 Use the **virtual sliders** and the **buttons** in the display to change the drawbars registration and enable or disable the various features.

Changing the drawbars registration

Drawbars registration is the combination of the drawbars positions, and affects the harmonic content of the organ sound.

To adjust the position of the corresponding drawbars:

- Use the **CONTROL sliders** on the control panel.

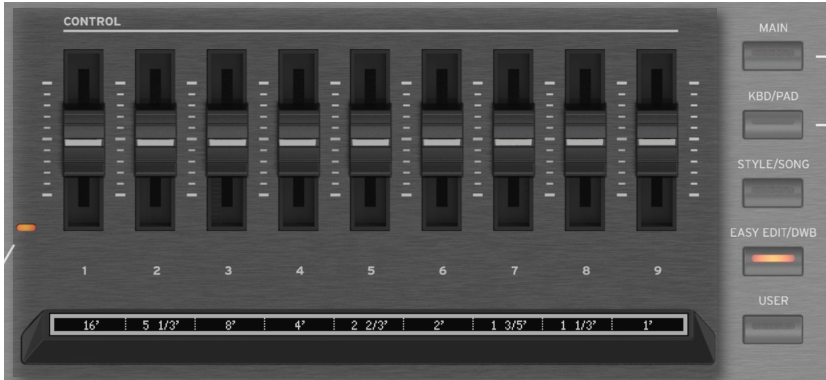

- Drag the **virtual sliders** in the display.

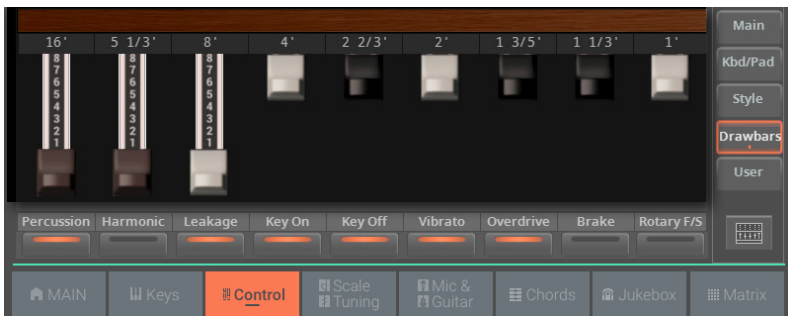

Turning the switches on/off

To enable or disable the sound parameters, or to trigger the controls, do as follows.

- Use the **CONTROL buttons** on the control panel.



- Use the **soft buttons** in the display.

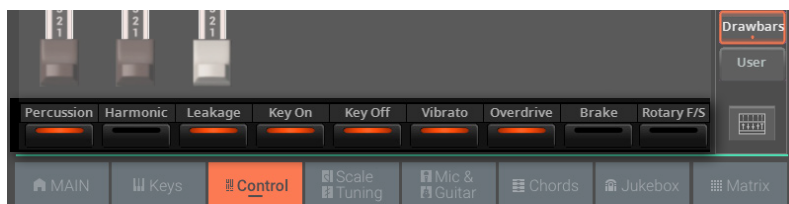

Please note that Vibrato/Chorus, Overdrive, Brake and Rotary Slow/Fast controls will be only working if the following Insert FXs are recalled and enabled for the Digital Drawbars Sound: Organ Vibrato/Chorus, CX-3 Amp, one of the Rotary Speakers.

■ Percussion

Percussion adds a pronounced percussive sound to the attack segment of the organ sound. You can turn it on or off.

■ Harmonic

You can change the harmonic content to the percussive attack. When the indicator is on, the second harmonic is selected. When it is off, the third one is selected.

■ Leakage

Leakage increases the bleed of signal between adjacent tonewheels, with signal from other tonewheel entering an unwanted pickup. This makes the sound 'dirtier', but also richer. You can turn it on or off.

■ Key On and Key Off

The organ keyboard can produce a click noise when pressed (Key On) or released (Key Off). You can turn this noise on or off.

■ Vibrato/Chorus

This is a combined chorus and vibrato effect. How it behaves depends on the selected options in the Sound. You can turn it on or off.

■ Overdrive

The overdrive simulator recreates the amp distortion, increasing realism. You can turn it on or off.

■ Brake

When enabling this control, the rotary speaker gradually slows down, and then stops entirely. When disabling it, the rotary speaker starts rotating again.

■ Rotary Fast/Slow

The rotary speaker can run slow or fast. Turn this button on to make it run fast, turn it off to make it run slow.

Editing the Digital Drawbars

Digital Drawbars and the effects

When editing a Digital Drawbar Organ, we suggest you start from one of the supplied Keyboard Sets and use the effect routing we created for you.

If you prefer to create an entirely new set, please remember that some insert effects must be activated on the same track of the DRAWBARS Sound. To be sure they are automatically selected, check the **Use IFX** option from the **page menu** (☰) of the **Sound Select** window.

DWB FX	IFX
Vibrato	Organ Vib/Chorus
Amplifier/Overdrive	CX-3 Amp
Rotor	Rotary Speaker, Rotary Speaker OD, CX-3 Rotary Speaker

Accessing the Digital Drawbars Edit page

Accessing the edit page from the control panel

- 1 Choose a Keyboard Set containing a Digital Drawbars Sound, or a Digital Drawbars Sound.
- 2 Press the **EASY EDIT/DWB** button in the **CONTROL** section of the control panel, then press it a second time to access editing.



- 3 Press the **EASY EDIT/DWB** button again, or press the **EXIT** button, to exit from the edit page.

Accessing the edit page from the display

- 1 Choose a Keyboard Set containing a Digital Drawbars Sound, or a Digital Drawbars Sound.
- 2 Touch the **Drawbars** button in the **Home > Control** page, then touch it a second time to access editing.

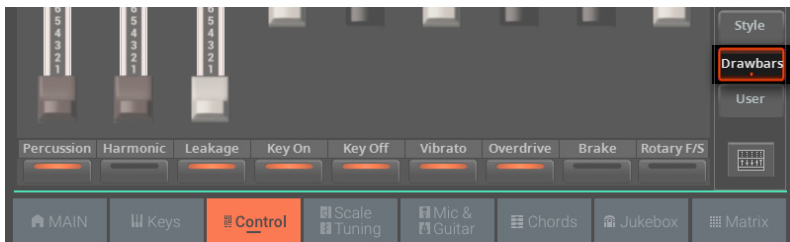

- 3 Touch the **Drawbars** button again, or press the **EXIT** button, to exit from the edit page.

Editing the Digital Drawbars parameters

Editing the parameters

The **Digital Drawbars Edit** page lets you edit in depth the various parameters of the organ's sound.



Please note that Vibrato/Chorus, Overdrive, Brake and Rotary Slow/Fast controls will be only working if the following Insert FXs are recalled and enabled for the Digital Drawbars Sound: Organ Vibrato/Chorus, CX-3 Amp, one of the Rotary Speakers.

Vibrato/Chorus

This effect simulates the vibrato and chorus circuitry (also called the Vibrato Scanner) of a vintage organ.



Parameters

Meaning

On/Off	Use this switch to enable or disable Vibrato/Chorus.
V1, V2, V3	Selects one of the variations of vibrato.
C1, C2, C3	Selects one of the variations of chorus.
Custom	Allows your own programming of the parameters.

Amplifier

This is a detailed model of the amp of a classic tone-wheel organ, producing a warm, fat tone. With the addition of the 3-band EQ, this amp simulation will allow you to create a very versatile distortion.

Please note that these parameters can only be accessed if the CX-3 Amp effect is selected.

HINT: When the Organ amp is select, you should choose Bypass as the cabinet. This would prevent having at the same time the organ’s own cabinet and a guitar cabinet. However, you are free to experiment with any combination.

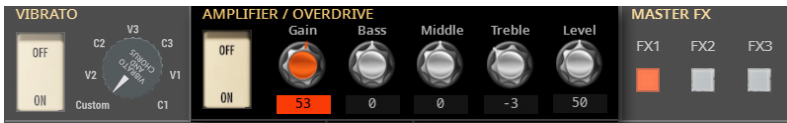

Parameters	Values	Meaning
On/Off	On, Off	Use this switch to enable or disable the Amplifier.
Gain	0...100	This adjusts the preamp gain, therefore the overdrive. With higher Gain values, you can reach heavy distortion; with Gain = 0, the amp will always remain clean. If an Expression pedal is connected, you can use it to control the amount of overdrive and distortion (by assigning it the Drawbars Overdrive function).
Bass	-10...10	Adjusts the bass frequencies.
Middle	-10...10	Adjusts the middle frequencies.
Treble	-10...10	Adjusts the treble frequencies.
Level	0...100	Amp’s output level.

Master Effects (FX1-3)

You can use the **FX1**, **FX2** and **FX3** buttons to enable or disable the corresponding send to the master effects.

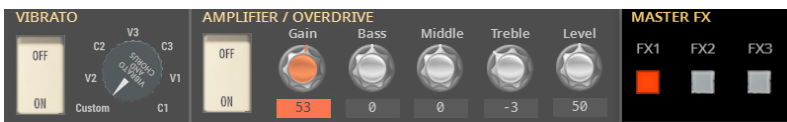

Percussion

Percussion adds a percussive sound to the attack segment of the organ sound.



Parameters	Meaning
On/Off	Use this switch to enable or disable the percussion.
Volume	Volume level of the percussive sound. Soft makes percussion less perceivable.
Decay	Decay speed of the percussive sound (Fast or Slow).
Harmonic	Selects a percussion harmonic between the Second and Third one.
Mode	If All, the percussive attack is played on all notes of a chord. If 1st, the percussive attack is played only on the first note of a chord or a group of held notes. Release all notes to trigger the percussion again.

Tone

Tone is the waveshape of the drawbars, producing the raw timbre.



Tone	Meaning
Mellow	A mellower-sounding wave.
Normal	A harder-sounding wave.

Noise

Here you can enable/disable and set the level of **Leakage**, **Key On** and **Key Off**.



Noise	Meaning
On/Off	Use these switches to enable or disable the corresponding effect.
Leakage	Sets the level of Leakage, increasing the bleed of signal between adjacent tonewheels, with signal from other tonewheel entering an unwanted pickup. This makes the sound 'dirtier', but also richer.
Key On	Set the level of the click noise produced by the organ keyboard when pressed (Key On) or released (Key Off).
Key Off	

Rotor

The Rotary Speaker's rotation speed, and the balance between horn and rotor, can be edited.

Please note the individual parameters can only be accessed if one of the insert effects (IFX) or master effects MFX has the Rotary Speaker effect assigned and activated. In case there isn't, some or all of the parameters in this section might not be accessible.



Rotor	Value	Meaning
Rotor On/Off	On, Off	Use this switch to start or stop the rotating speaker.
Speed	Slow, Fast	Use this slider to switch the rotating speaker's speed (from slow to fast, or vice-versa).
Rotor/Horn Balance	Rotor, 1...99, Horn	Adjusts the balance between the low-frequency rotor and the high-frequency horn.

Drawbars

Drag the drawbars to create the raw sound of the tonewheels. Each drawbar corresponds to an organ's stop, corresponding to a harmonic, as in the following table. Pull a drawbar out to increase its volume, push it in to reduce it.



Stop	Meaning
16'	An octave below the fundamental frequency (sub-octave).
5 1/3'	One third below the fundamental frequency (sub-third).
8'	Fundamental frequency (unison).
4'	An octave over the fundamental frequency (first harmonic).
2 2/3'	One twelfth over the fundamental frequency (third harmonic).
2'	Two octaves over the fundamental frequency (second harmonic).
1 3/5'	One seventeenth over the fundamental frequency (fifth harmonic).
1 1/3'	One nineteenth over the fundamental frequency (sixth harmonic).
1'	Three octaves over the fundamental frequency (eighth harmonic).

18

Global settings and Preferences

Customizing the user interface

Display and control panel preferences

Choosing the chords and alphanumeric keyboard language

You can choose the language used to show chord names and the characters that can be inserted using the alphanumeric virtual keyboard. Please note that some of the characters can only be used when editing SongBook Entry names.

- 1 Go to the **Settings > Menu > General Controls > Interface** page.
- 2 Use the **Language** pop-up menu to select one of the available languages.

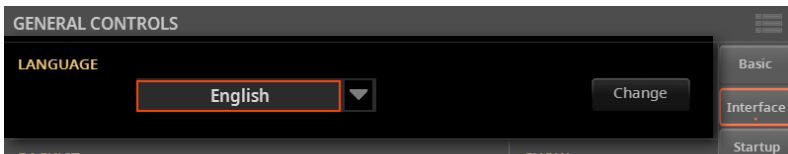

- 3 Touch the **Change** button to apply the selected language.

Control panel and Matrix illumination

You can adjust the brightness of the control panel's button indicators, to adapt the control panel glowing/luminosity to the ambient light. A separate control allows for adjusting the Matrix buttons luminosity.

- 1 Go to the **Settings > Menu > General Controls > Interface** page.
- 2 Use the **Backlit > Panel** and **Matrix** pop-up menus to select one of the available luminosity degrees.

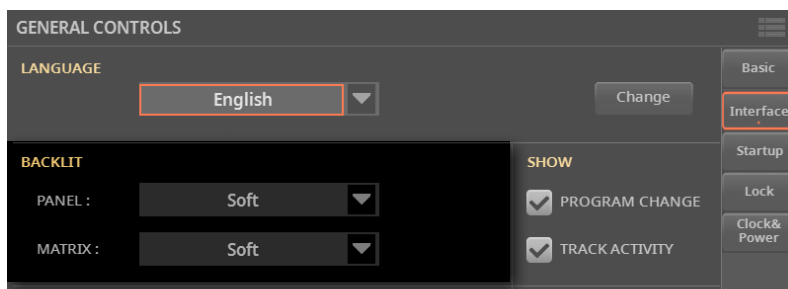

Main display and strip display illumination

You can adjust the luminosity of the main display and strip display.

- 1 Go to the **Settings > Menu > General Controls > Interface** page.
- 2 Use the **Display Brightness > Main** and **Strip** controls to adjust the corresponding luminosity.

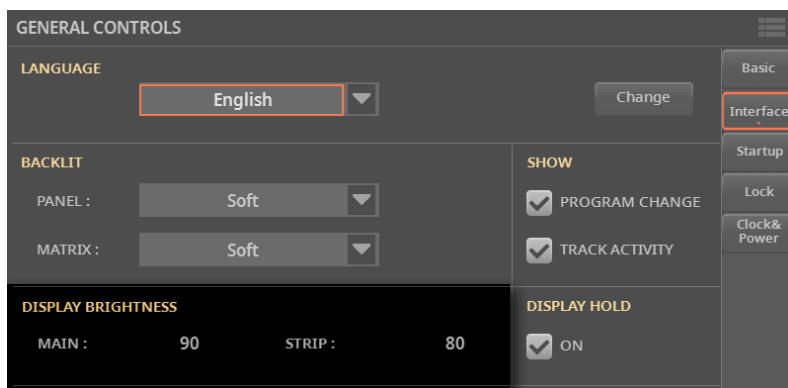

Automatically closing the Select windows

You may prefer to leave a **Select** window open after you have chosen a Sound, Keyboard Set, Style, Song, Pad, Chord Sequence, Mic or Guitar Preset, to continue trying other elements in that window. Or, you may prefer it automatically closes after you have completed your choice. This is determined by the **Display Hold** parameter.

- 1 Go to the **Settings > Menu > General Controls > Interface** page.
- 2 Select the **Display Hold** checkbox to let the Select windows remain open until you press the **EXIT** button. Deselect it to let the Select windows automatically close after you choose an element.

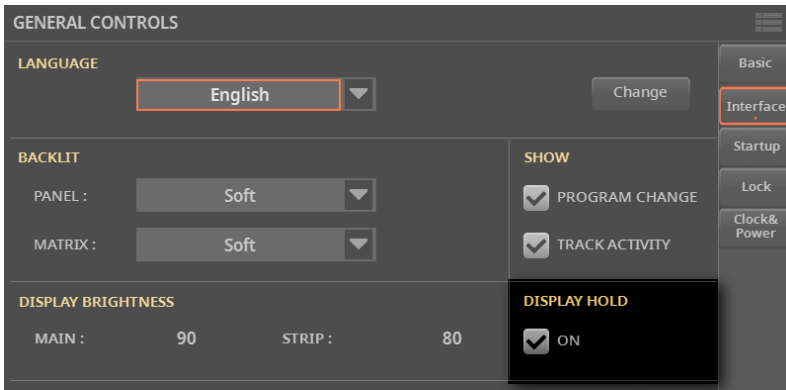

Program Change and activity indicators

Showing/Hiding the Program Change number

You can make Program Change numbers be shown next to Sound names in the **Sound Select** window.

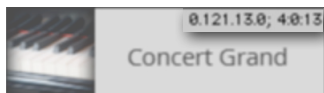

Please note that Program Change numbers are always shown in the **Home > Menu > Mixer/FX > Main** page.

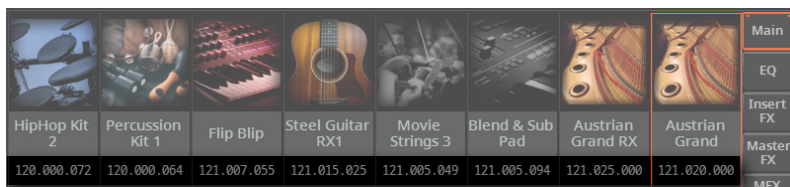

- 1 Go to the **Settings > Menu > General Controls > Interface** page.
- 2 Select/deselect the **Show > Program Change** checkbox.

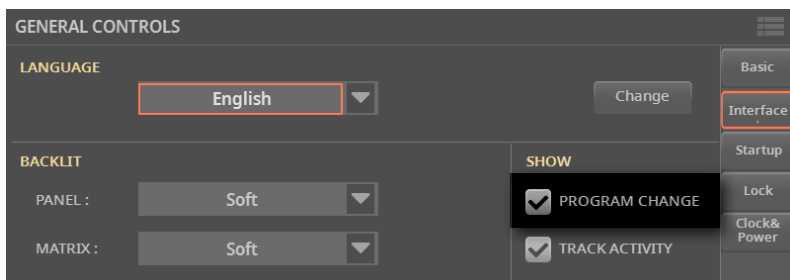

Showing/Hiding the track's activity

You can turn on/off the **Track Activity** display. When it is turned on, you can monitor events coming from the internal Sounds or the MIDI messages. Incoming events are shown by the color changing on each track's label.



This lets you see the source of the audio signal. When mixing, you can mute or solo the various channels, and see each Sound's contribution to the overall mix.

Color	Sound
Green	Keyboard
Orange	Style, Song or Pad from Player 1
Blue	Style, Song or Pad from Player 2

- 1 Go to the **Settings > Menu > General Controls > Interface** page.
- 2 Select/deselect the **Show > Track Activity** checkbox.

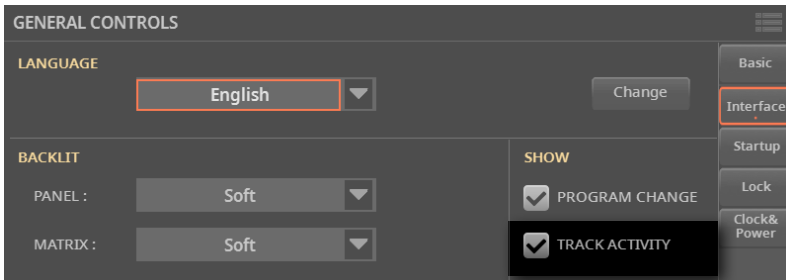

Automatic selection and locking

Automatically choosing Styles and Keyboard Sets

When the **Auto Select** option is activated, the latest Style or Keyboard Set you selected in a category will be automatically chosen when touching the name of that category. If no Style or Keyboard Set has been selected for that category, the first item it contains will be automatically chosen.

This way, you can select a Style or Keyboard Set at the press of a button, or the touch of a single icon.

Automatically selecting the Styles

When the **Auto Select > Style** parameter is activated, touching the **name of a Style category** in the **Select** window will automatically select the Style you latest selected in that category.

The **Select** window will still appear, so that you can select a different item if desired.

- 1 Go to the **Settings > Menu > General Controls > Interface** page.

2 Select the **Auto Select > Style** checkbox.

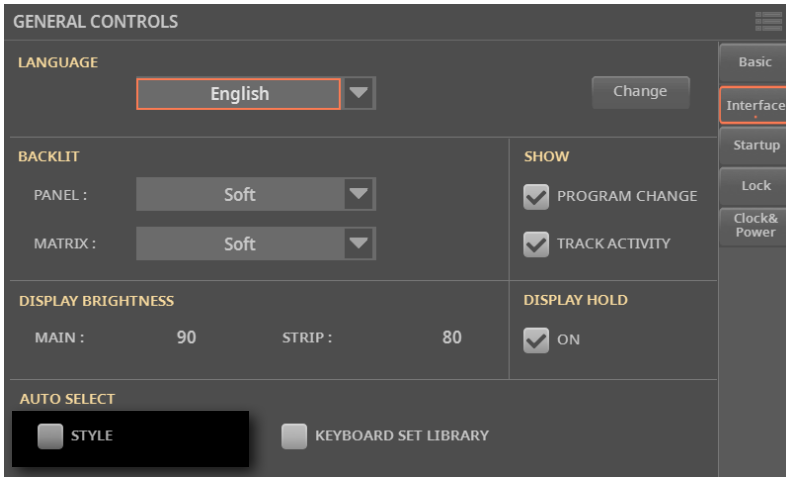

The assigned Styles are memorized when turning the instrument off.

Automatically selecting the Keyboard Sets from the library

When the **Auto Select > Keyboard Set Library** parameter is activated, pressing one of the **KEYBOARD SET LIBRARY** buttons, or touching the **name of a Keyboard Set category** in the **Select** window, will automatically select the Keyboard Set you latest selected in that category.

The **Select** window will still appear, so that you can select a different item if desired.

- 1 Go to the **Settings > Menu > General Controls > Interface** page.
- 2 Select the **Auto Select > Keyboard Set Library** checkbox.

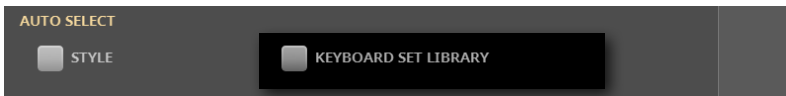

The assigned Keyboard Sets are memorized when turning the instrument off.

Assigning startup elements to the Players

You can assign to the Players a Style or a Song to be automatically selected when turning the instrument on. This way, you will be immediately ready to start your performance.

You can also select a Jukebox (.jbx) file, so that you can have background music playing before the show begins.

- 1 Go to the **Settings > Menu > General Controls > Startup** page.
- 2 Touch the **Select (...)** button corresponding to each of the Players to select a Style or a Song.

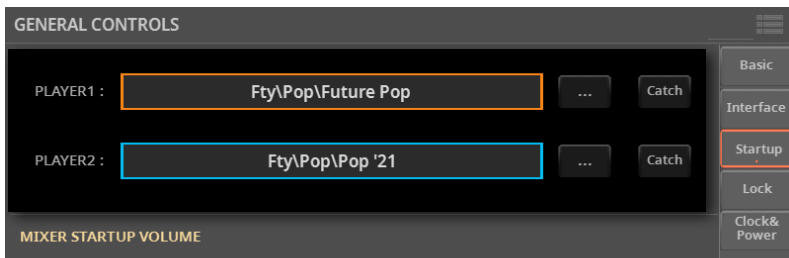

- 3 If you want to choose the Style or Song currently assigned to the Players, touch the corresponding **Catch** button.

Settings a startup level for the audio inputs, the Players and the keyboard

You can assign a startup volume to the audio inputs, the Players and the keyboard when turning the instrument on. This way, you will be sure all the elements are well balanced when beginning your performance.

- 1 Go to the **Settings > Menu > General Controls > Startup** page.
- 2 Use the parameters in the **Mixer Startup Volume** section to set the startup levels.

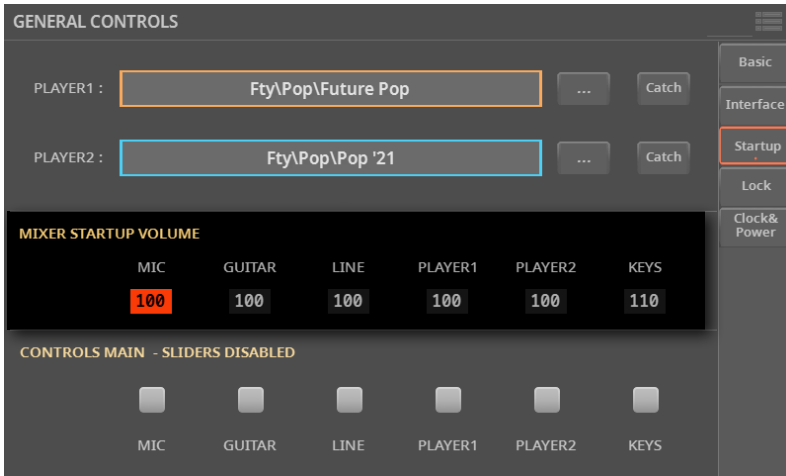

Preventing level change for the audio inputs, the Players and the keyboard

You can prevent the volume of the sensitive controls for the audio inputs, the Players and the keyboard, to be accidentally changed.

- 1 Go to the **Settings > Menu > General Controls > Startup** page.
- 2 Use the checkboxes in the **Controls Main - Sliders Disabled** section to disable the relevant sliders in the **CONTROL** section.

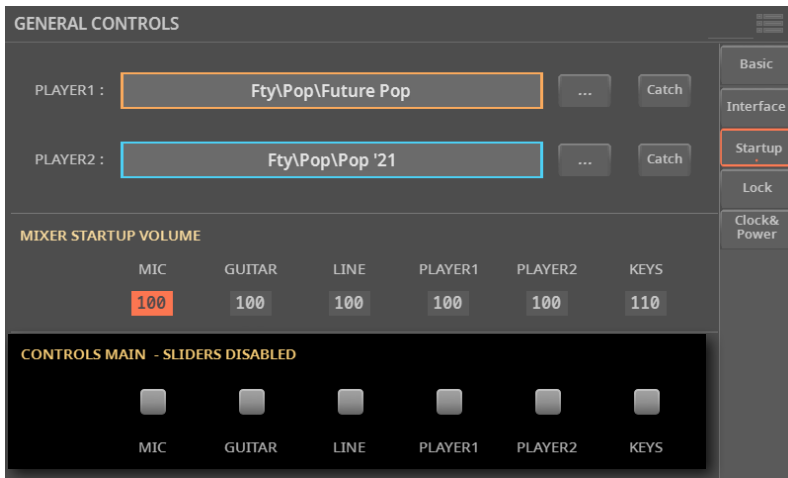

Locking parameters to prevent changes

In various pages, next to some parameters, you can find a lock (🔒) icon. All these locks are collected in the **Settings > Menu > General Controls > Lock** pages for easy access.

Locking the Control parameters

The **Control** section includes the Keyboard Sounds, Pads and Assignable Switches on the control panel.

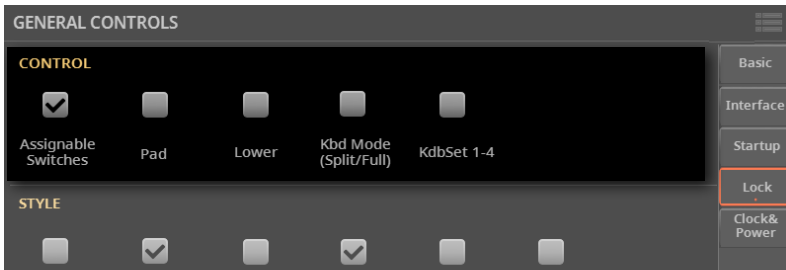

Control lock	Meaning
Assignable Switches	When locked, selecting a Keyboard Set will not change the functions assigned to the Assignable Switches.
Pad	When locked, selecting a Style or SongBook Entry will not change the Pads.
Lower	<p>When this lock is closed, the Lower Sound (and its play/mute status) remains unchanged when a different Keyboard Set or Style is selected. As expected, the Lower Sound will disappear when you switch from the Split to the Full keyboard mode.</p> <p>Hint: If you want the same Lower settings to be used during all your shows, save your preferred Lower settings to the MY SETTING Keyboard Set (automatically selected on startup), and close this lock.</p>
Keyboard Mode (Split/Full)	<p>When this lock is closed, the status of the SPLIT button (therefore of the keyboard mode) remains unchanged when a different Keyboard Set is selected.</p> <p>Hint: If you want the same Lower settings to be used during all your shows, save your preferred Lower settings to the MY SETTING Keyboard Set (automatically selected on startup), and close this lock.</p>
Keyboard Set 1-4	<p>When this lock is closed, the four currently selected Keyboard Sets are preserved, when choosing a different Style or SongBook Entry.</p> <p>With this lock open, selecting a Style or SongBook Entry will select the four Keyboard Sets they contain.</p>

Locking the Style parameters

The **Style** section includes controls for the Styles.

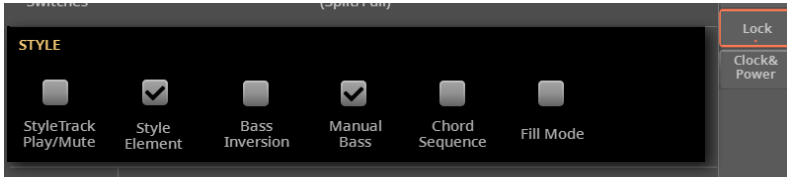

Style locks	Meaning
Style Tracks Play/Mute	When this lock is closed, choosing a Style does not change the Play/Mute status of the Style tracks. This way, you can, for example, turn the bass track off during a whole show, to allow your bassist to play the part live. Also, you could mute all the Acc tracks, to only play with the Drum and Bass tracks.
Style Element	When this lock is closed, choosing a Style does not change the selected Style Element (Variation, Intro...). This lock does not apply to the Fills and Break. This lock has no effect on the Styles that are automatically selected when choosing a SongBook Entry. In this case, the Style Element memorized in the SongBook Entry is always selected.
Bass Inversion	When locked, choosing a Keyboard Set will not change the Bass Inversion status.
Manual Bass	When locked, choosing a Keyboard Set will not change the Manual Bass status.
Chord Sequence	When locked, choosing a Style or SongBook Entry will not change the Chord Sequence in memory.
Fill Mode	When locked, the selected Fill Mode will not change when choosing a different Style or SongBook Entry.

Locking the Songs parameters

The **Song** section includes a single control for the MIDI Songs.



Style locks

Meaning

Song Tracks Play/
Mute

When this lock is closed, choosing a MIDI Song does not change the Play/Mute status of the Song tracks. This way, you can, for example, turn the solo track off during the whole show, to let you play or sing it live.

Locking the Tuning parameters

The **Tuning** section includes controls for Transpose and Scale.

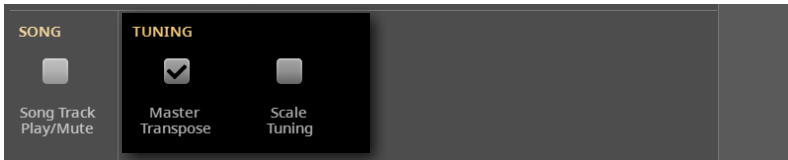

Tuning lock

Meaning

Master Transpose

Prevents Master Transpose from changing when choosing a SongBook Entry. It also prevents transposing when loading a Standard MIDI File created by Pa5X or any instrument of the KORG Pa-Series.

Scale Tuning

Prevents the Scale settings from changing when choosing a Keyboard Set or SongBook Entry.

System preferences

Setting the date and time for the files

Pa5X includes a battery-backed system calendar and clock. This allows for automatically adding a time-stamp to the files, when they are created or edited.

- 1 Go to the **Settings > Menu > General Controls > Clock & Power** page.
- 2 Set the **Time** and **Date**. Input the **Time** as 'hour : minute : second'. Input the **Date** as 'Month / Day / Year'.
- 3 Choose whether you prefer the 12- or 24-hour time format using the **Clock Format** parameter.
- 4 After having edited all the parameters, touch the **Apply** button to apply the changes.

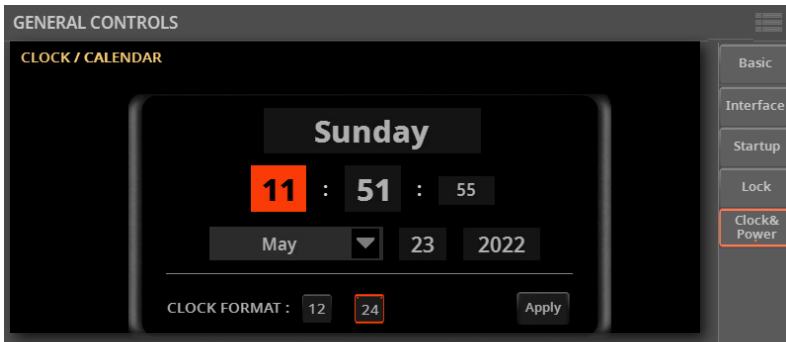

Automatic power off

Pa5X can automatically enter standby after two hours of not being used, to save energy and help preserving the environment.

- 1 Go to the **Settings > Menu > General Controls > Clock & Power** page.
- 2 Select/deselect the **Auto Power Off** checkbox.

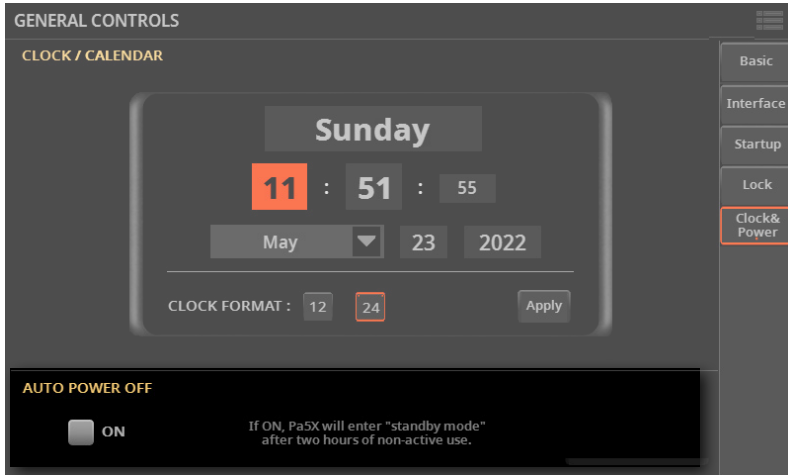

When this parameter is checked, a few minutes before automatic standby a message will warn you that the instrument is going to be put in standby. All unsaved data currently in edit will be lost.

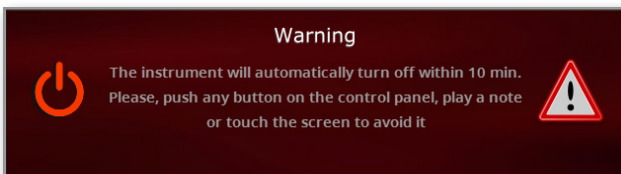

At this message, you can let the instrument enter standby, or you can touch the display, press any button on the display, or play the keyboard to leave it turned on and continue using it.

19

Tuning and Scale

Master Transpose and Tuning

Master Tuning

You can fine tune the instrument (in cents of a semitone), to adapt it to an acoustic instrument that is not possible to tune (for example an acoustic piano without a professional tuner or the right tools, or a period instrument).

1 Go to the **Settings > Menu > Tuning > Master Tuning** page.

As an alternative, keep the **SHIFT** button pressed and press either or the **TRANPOSE** buttons.

2 Use the **Master Tuning** parameter to fine tune the instrument.



Tuning	Meaning
-100 cents	Lowest pitch (half a semitone down)
0 cents	Standard pitch (A4 = 440Hz)
+100 cents	Highest pitch (half a semitone up)

Master Transpose

Transposing the instrument as whole

The instrument's key can be transposed to make singing or playing together with another instrument more comfortable. The transpose value is usually shown in the status bar.



Master Transpose settings are also sent to any GM-compliant instrument connected to the **MIDI OUT** or **USB DEVICE** port.

■ Transpose down from the control panel

> Use the **TRANPOSE > FLAT (b)** button to lower the Master Transpose in steps of one semitone.

■ Transpose up from the control panel

> Use the **TRANPOSE > SHARP (#)** button to raise the Master Transpose in steps of one semitone.

■ Reset transposition

> Press both **TRANPOSE** buttons together.

Choosing where to apply transposition

You can turn on or off the Master Transpose to any of the parts of the instrument.

1 Go to the **Settings > Menu > Tuning > Transpose Control** page.

As an alternative, keep the **SHIFT** button pressed and press either or the **TRANPOSE** buttons.

2 Use the **Master Transpose** section to turn each part on or off.

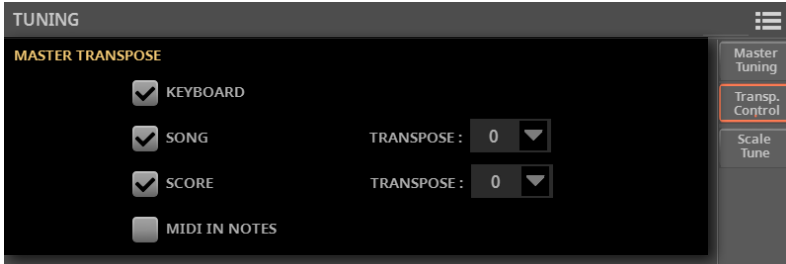

Part	Applies to...
Keyboard	All the Keyboard Sounds.
Song	MIDI and MP3 Songs. You can use the Transpose pop-up menu to choose an additional transpose value.
Score	Music score in the Score page. You can use the Transpose pop-up menu to choose an additional transpose value.
MIDI IN Notes	MIDI notes coming from the MIDI IN and USB HOST ports.

Transposing the Keyboard Sounds

When the **Master Transpose > Keyboard** option is selected in the **Settings > Menu > Tuning > Transpose Control** page, Master Transpose will be applied to the Keyboard Sounds.

Transposing the SongBook Entries

When saving a SongBook Entry, the current Master Transpose value is also saved. Master Transpose might therefore change when choosing a SongBook Entry. To avoid this to happen, you may lock the Master Transpose option in the **Settings > Menu > General Controls > Lock > Tuning**.

Transposing the MP3 Songs

MP3 Songs can be transposed inside a range of -5...+6 semitones. This range is enough to cover all they keys, while avoiding excessive audio degradation. Any further transposing will be reversed to fit the range. So, you might see a +7 transpose value (Just Fifth Up) shown in the display, but the MP3 Song will actually play 5 semitones lower (Just Fourth Down).

Transposing the MIDI Songs

When saving a MIDI Song, the Master Transpose value is saved with the Song. This value is preserved when choosing the Song again.

When choosing a MIDI Song containing Master Transpose data, the instrument's Master Transpose is modified. This may cause problems with other Songs or when playing the Styles. To avoid this to happen, you may lock the Master Transpose in **Settings > Menu General Controls > Lock > Tuning**.

Transposing the notes coming from the MIDI IN

Master Transpose can be applied or prevented on the notes entering the **MIDI IN** or **USB HOST** or **DEVICE** ports.

1 Go to the **Settings > Menu > Tuning > Transpose Control** page.

As an alternative, keep the **SHIFT** button pressed and press either or the **TRANSPOSE** buttons.

2 Use the **MIDI IN Notes** option to activate/deactivate transpose on the incoming MIDI notes.

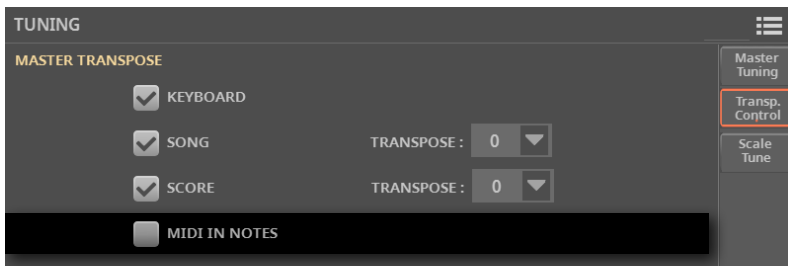

When is Master Transpose applied?

You can decide when the Master Transpose will take effect.

- 1 Go to the **Settings > Menu > Tuning > Transpose Control** page.
- 2 Use the **Transpose Cue Mode** pop-up menu to choose when transposition will be applied.

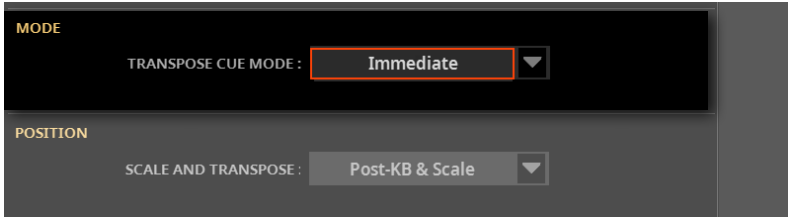

Transpose	Meaning
Next Measure	When you press either of the TRANSPOSE buttons, the new transpose setting will not take effect until the first beat of the next measure is reached.
Immediate	When you press either of the TRANSPOSE buttons, the new transpose setting will immediately occur when the next note is played by the Keyboard or Song, and on the next chord change by the Style. If, for example, you play a note on the keyboard when the Style is still playing a chord, only the Keyboard Sounds will be transposed, and the Style Sounds will only be transposed at the next chord.

Master Transpose and Scale

You can define the relation between the Scale and the Master Transpose.

- 1 Go to the **Settings > Menu > Tuning > Transpose Control** page.
- 2 Use the **Position > Scale and Transpose** pop-up menu to choose where transposition will be applied in relation to the Scale.

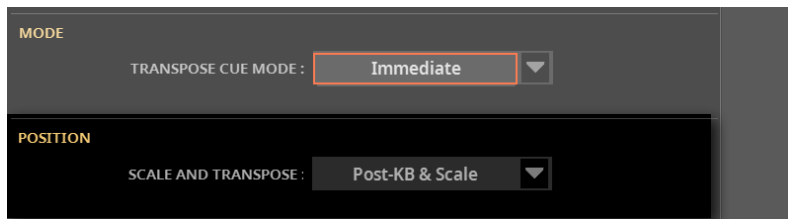

Transpose position	Meaning
Post-KB/Pre-Scale	When this option is selected, notes will be transposed immediately after they leave the keyboard. The Scale will be applied to the transposed notes. For example, if you altered an E, and then set the Master Transpose to +1, the E key will play a real F, and the altered key will still be E (that will play an altered E).
Post-KB & Scale	When this option is selected, all notes are transposed immediately before they enter the internal tone generator, or are sent to the MIDI OUT or USB DEVICE port, and after the Scale. For example, if you altered an E, and set the Master Transpose to +1, the altered key will still be E (that will play an altered F).

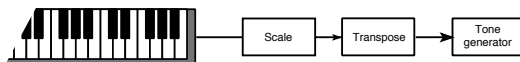

Drum Kits and Master Transpose

Drum Kits are never transposed. If you want an ordinary Sound not to be transposed as well, assign it to a track set to **Drum** mode in the **Home > Menu > Track Controls > Mode** page.

Opening the Master Transpose dialog

You can access most of the Master Transpose settings in the **Master Transpose** dialog.

1 Keep the **SHIFT** button pressed, and press one of the **TRANPOSE** buttons to open the Master Transpose dialog.

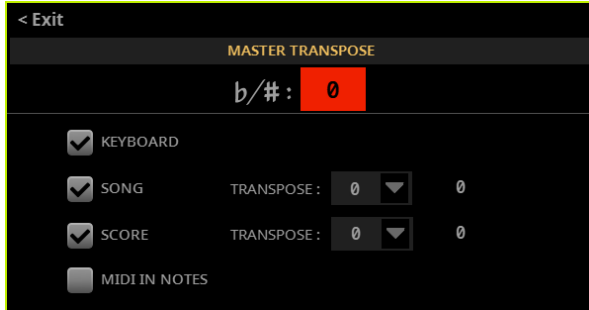

2 After having edited the parameters, press the **EXIT** button to close the dialog.

Transposing the score and the chord symbols

Where is transposition applied?

When using the **TRANPOSE** buttons, the music score and chord symbols may also be transposed in the **Lyrics** and **Score** pages, depending on the Master Transpose settings. You can combine the transpose options in the following three ways. These options are detailed in the following pages.

Transpose options	Score and Chord symbols
A Keyboard: On Song: On Score: Off	Score and Chord symbols are not transposed. The song can be read and played by the keyboard player, but not by a musical partner. The key you will hear is different from the one you will play.
B Keyboard: Off Song: On Score: On	Score and Chord symbols are transposed now. The song can be read and played by both the keyboard player and the musician partner. The key you will hear is the same as the one you will play.
C Keyboard: On Song: Off Score: On	Score and Chord symbols are transposed as well. The song can be read and played by the keyboard player but not by the musician partner. The key you will hear is different from the one you will play.

When no transposition is applied, the score and chord symbols always appear as in the original file.

The image shows two screenshots of a music player interface. The top screenshot shows the 'INTRODUCTION' section with a key signature of C#7 and a tempo of 120 bpm. The bottom screenshot shows a musical score with three chord symbols: D^b7, B^b7, and F^bm.

Score and chord symbols can be read in the internal display and/or an external monitor. They can be useful for you – the keyboard player – and/or your musician partner (a singer, a guitar player, a sax player...).

A) Transposing the Keyboard and Songs, but not the Score and the Chord symbols

Choose this option to let Pa5X transpose what you play live, together with the songs, to a key that is more comfortable for your musician partner. You will be the one to read the (non-transposed) score and chord symbols.

For example you may want to play a song in the original C# Maj key, because you learned it in that key. Your musician partner, on the contrary, prefers to play it in D Maj, that might be more comfortable for her/him.

By choosing a transpose value of +1, the songs will be transposed to D Maj. You will play in C# Maj, but your notes will be transposed to D Maj. This means, as a reference, when playing the keyboard, a C will be transposed to sound as a C#.

The score and chord symbols will not change, so you will still be able to read and play the score in the original key of C#.

1 Go to the **Settings > Menu > Tuning > Transpose Control** page.

As an alternative, keep the **SHIFT** button pressed and press either or the **TRANPOSE** buttons.

2 Select the **Keyboard** and **Song** checkboxes. Leave the **Score** checkbox not selected.

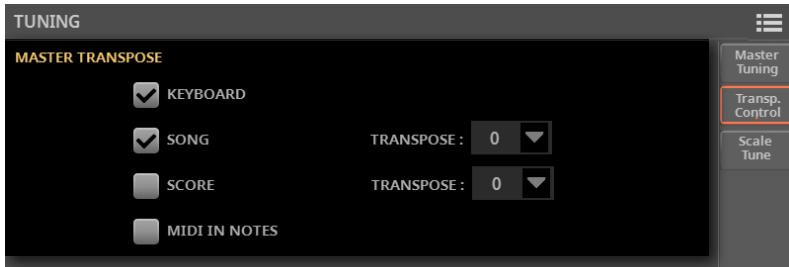

When changing the **Master Transpose** value, the keyboard and the songs will be transposed. The score and chord symbols will NOT be transposed.



B) Transposing the Songs, Score and Chord symbols, but not the Keyboard

Choose this option when you want to let Pa5X transpose the songs to a key that is more comfortable for you and your musician partner. Both of you will play in the transposed key. You and your musician partner will be able to read the (transposed) score and chord symbols.

For example, both you and your musician partner want to play a song, originally in the key of C# Maj, in D Maj, because it is easier for both of you.

By choosing a transpose value of +1, the songs will be transposed to D Maj. The keyboard will not be transposed, so you will play right in D Maj. This means, as a reference, that when playing the keyboard, a C will still be a C.

The score and chord symbols will change, so you will be able to read and play the score in the transposed key of D Maj.

1 Go to the **Settings > Menu > Tuning > Transpose Control** page.

As an alternative, keep the **SHIFT** button pressed and press either or the **TRANPOSE** buttons.

2 Select the **Song** and **Score** checkboxes. Leave the **Keyboard** checkbox not selected.

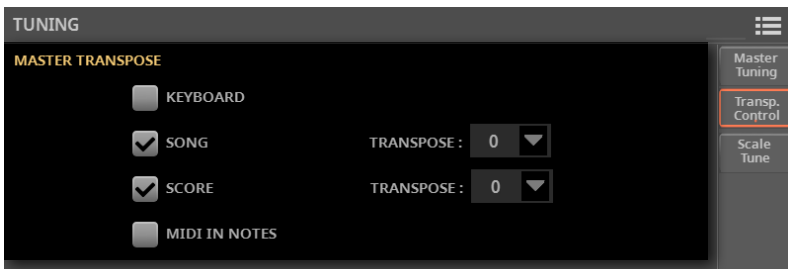

When changing the **Master Transpose** value, the keyboard will NOT be transposed, while the songs, score and chord symbols will be transposed.

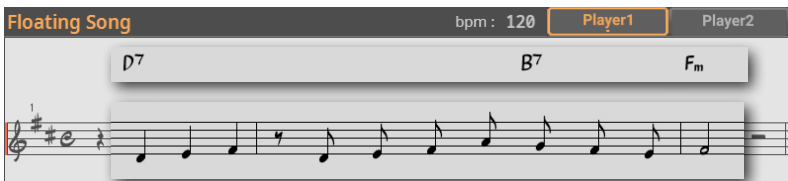
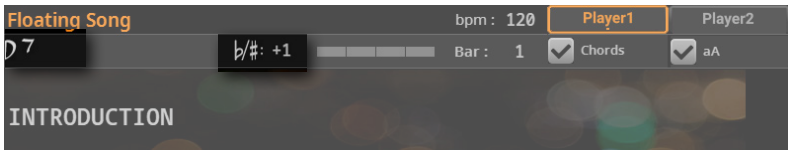

C) Transposing the Keyboard, Score and Chord symbols, but not the Songs

Choose this option to transpose what you play live to a more comfortable key, and let your musician partner play in the original key. You will be the one to read the (transposed) score and chord symbols.

For example, if you find a song in C# Maj too difficult to play, you can play it in C Maj. By choosing a transpose value of +1, what you play on the keyboard will be transposed to C# Maj. This means, as a reference, that when playing the keyboard, a C will be transposed to sound as a C#.

The score and chord symbols will have a transpose value of -2, so that you can read them in the altered key.

The songs will not be transposed, so your musician partner will be in tune with them, but will not be able to read the correct score or the chords, because they are transposed for you, the keyboard player.

1 Go to the **Settings > Menu > Tuning > Transpose Control** page.

As an alternative, keep the **SHIFT** button pressed and press either or the **TRANPOSE** buttons.

2 Select the **Keyboard** and **Score** checkboxes. Leave the **Song** checkbox not selected.

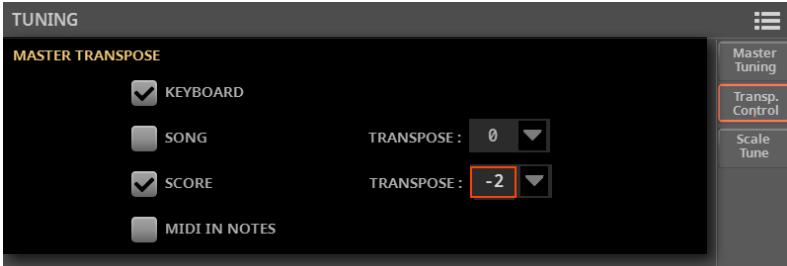

When changing the **Master Transpose** value, the keyboard, score and chord symbols will be transposed. The songs will NOT be transposed.

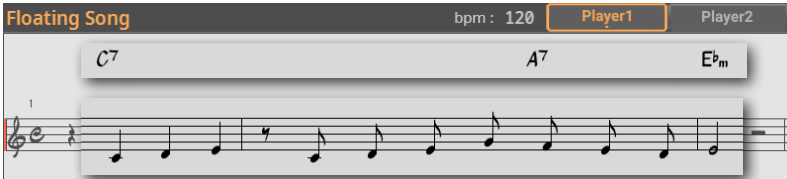
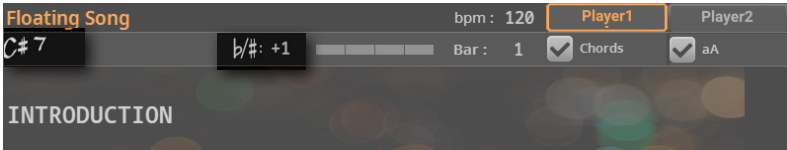

Scale

Choosing the Main Scale

The main scale is usually applied to all or most of the Sounds. Some Sounds may use an alternative sub-scale. Some Style Elements may use alternative sub-scales. The main scale is used wherever there is no sub-scale assigned.

■ Choose the main scale

- 1 Go to the **Settings > Menu > Tuning > Scale/Tune** page.
- 2 Use the **Main Scale/Tune** pop-up menu to choose the main scale of the instrument.

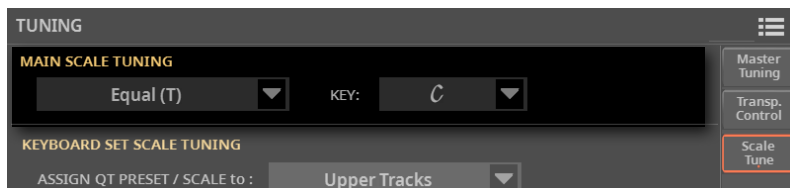

All Sounds, apart for those for which a different sub-scale has been selected when choosing a Keyboard Set, will use this scale.

■ If needed, choose a root key

- > Use the **Key** parameter (needed with some scales) to set the scale root (therefore, the Sound's tuning).

Scales list

Scale	Description
Equal	Equal tuning, the standard scale for modern Western music. It is made of 12 identical semitones.
Pure Major	The main major chords in the selected key are perfectly tuned.
Pure Minor	The main minor chords in the selected key are perfected tuned.
Arabic	An Arabic scale, using quarters of tone. Set the Key parameter as follows: C – for the 'rast C/bayati D' scale D – for the 'rast D/bayati E' scale F – for the 'rast F/bayati G' scale G – for the 'rast G/bayati A' scale A# – for the 'rast Bb/bayati C' scale
Pythagorean	Pythagorean scale, based on the music theories of the great Greek philosopher and mathematician Pythagoras. It is most suitable for melodies with an ancient flavor.
Werckmeister	Late Baroque and early Classic age scale. Very suitable for 18th Century music.
Kirnberger	Harpsichord scale, very common during the 18th Century.
Slendro	Scale of the Indonesian Gamelan. The octave is divided in five notes (C, D, F, G, A). The remaining notes are tuned as in the Equal tuning.
Pelog	Scale of the Indonesian Gamelan. The octave is divided in seven notes (all white keys, when Key is = C). The black keys are tuned as in the Equal tuning.
Stretch	Simulates the 'stretched' tuning of an acoustic piano. Basically an equal tuning, the lowest notes are slightly lower, while the highest notes are slightly higher than the standard.
User	User scale, only available as a sub-scale. The User scale can be saved to a Keyboard Set. You can't select it as the main scale in the Settings.

Choosing a Sub-Scale (Keyboard and Style Sounds)

You can assign a scale different from the main scale (therefore, a sub-scale) to the Keyboard Sounds. This will allow, for example, to play a piano solo with the Stretch tuning, while the backing tracks continue to play in the Equal tuning. A different sub-scale can be saved into each Keyboard Set.

You can also assign a sub-scale to all the Sounds of the Style, separately from the Sounds of a MIDI Song (that will still use the main scale). So, you will be able to play the Styles with a sub-scale, and the Songs with the main scale.

■ Choose a sub-scale

1 Go to the **Home > Scale/Tuning** pane.

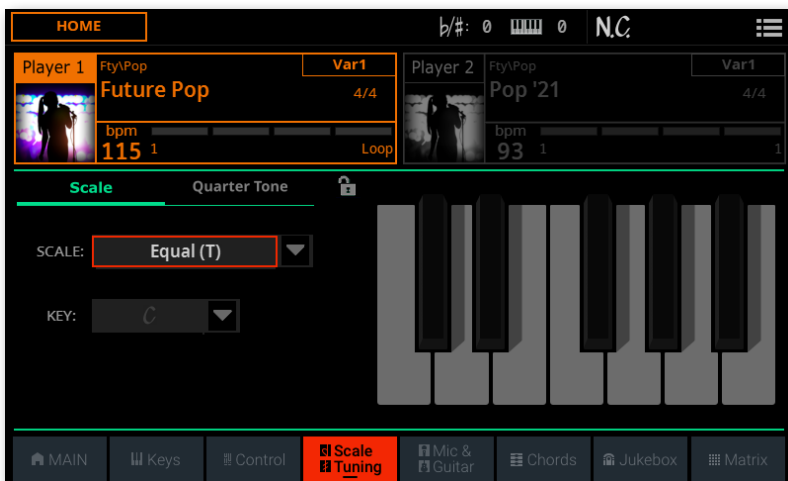

2 Use the **Scale** pop-up menu to choose the sub-scale. See above for a list of the available scales.

> If needed, use the **Key** parameter (requested by some scales) to set the preferred key.

■ Assign the sub-scale to the Keyboard and/or Style Sounds

1 Go to the **Settings > Menu > Tuning > Scale/Tune** page.

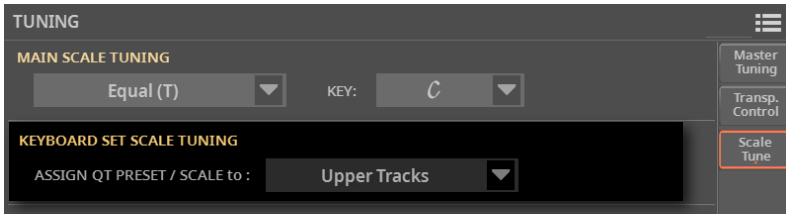

2 Use the **Assign QT Preset/Scale to** pop-up menu to choose the Sounds to which the sub-scale is applied. All the other Sounds will use the main scale.

Scale Mode	Meaning
KbdSet Tracks	The sub-scale will affect all the Keyboard Sounds
Upper Tracks	The sub-scale will only affect the Upper 1-3 Keyboard Sounds
KbdSet+Style Tracks	The sub-scale will affect the Keyboard Sounds and the Style Sounds. It will not affect the MIDI Song Sounds.

Choosing and editing the User Sub-Scale (Keyboard and Style Sounds)

In addition to the supplied scales, you can program your own User sub-scale. The User sub-scale can then be saved to a Keyboard Set or Style, to allow for a different scale fitting that particular musical style.

■ Choose the User sub-scale

- 1 Go to the **Home > Scale/Tuning** pane.

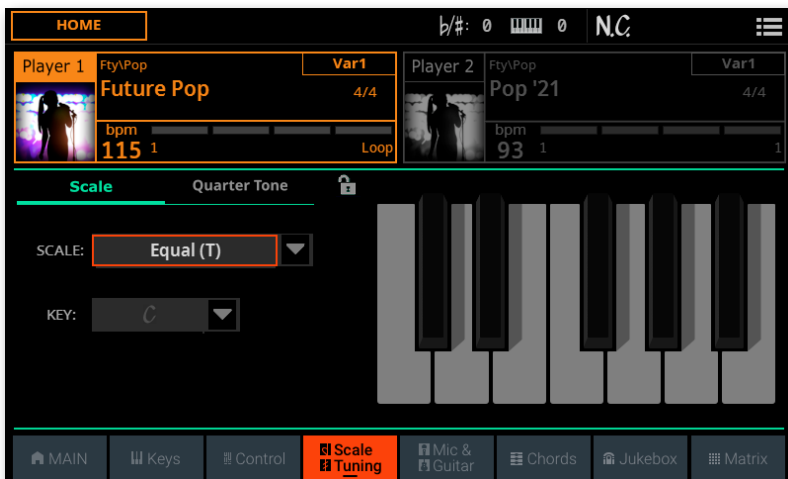

- 2 Use the **Scale** pop-up menu to choose the **User** sub-scale.

■ Edit the User sub-scale

When the **User** sub-scale is selected, the keyboard diagram will become active, letting you program a custom scale.

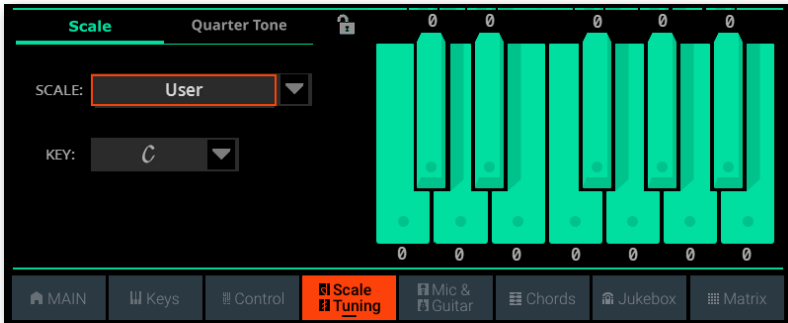

> Use the **numbers** appearing next to each note of the keyboard diagram to fine tune each note pitch. Detuning is referred to Equal tuning considered as ‘zero detune’.

Detuning

-99 ... +99

Meaning

Note detuning in cents or a semitone. Zero is no detuning (Equal tuning), ± 50 is a full quarter tone up or down, ± 99 is nearly one whole semitone up or down.

■ Save the User sub-scal

> Save the changes to a Keyboard Set or a Style.

Using the Scale Presets

Choosing the Scale Presets from the display

You can instantly recall a Quarter Tone sub-scale, by just choosing one of the Scale Presets.

■ Activate the Quarter Tone sub-scale

- 1 Go to the **Home > Scale/Tuning** pane.

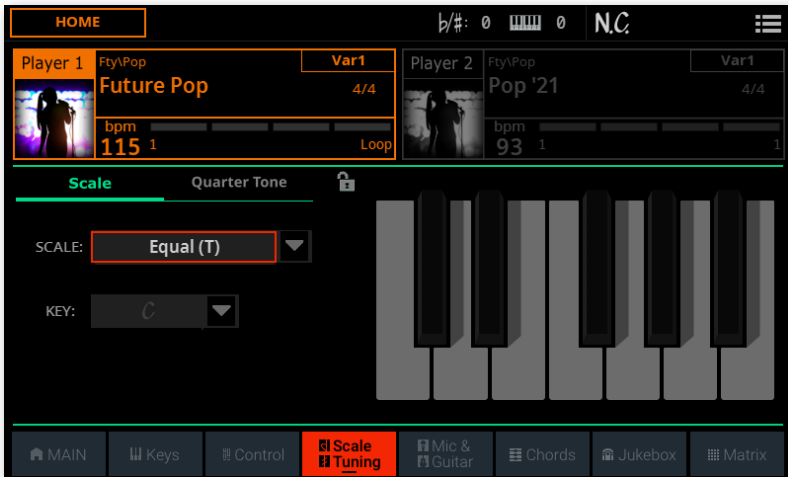

- 2 Touch the **Quarter Tone** tab on top of the pane. The **Scale Preset** buttons will appear.

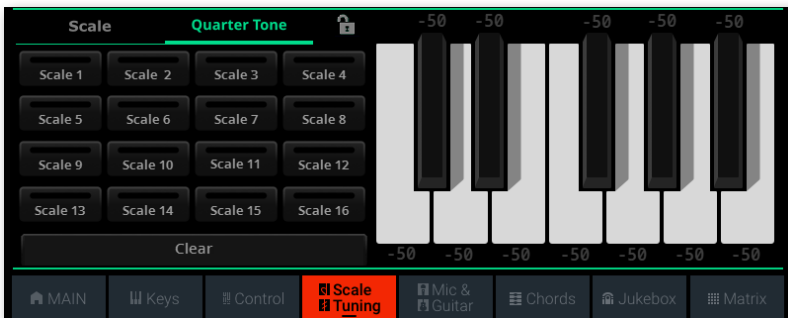

■ Choose a Scale Preset

- > Touch one of the **Scale** buttons to choose the corresponding **Scale Presets**. The saved Quarter Tone sub-scale will be selected.

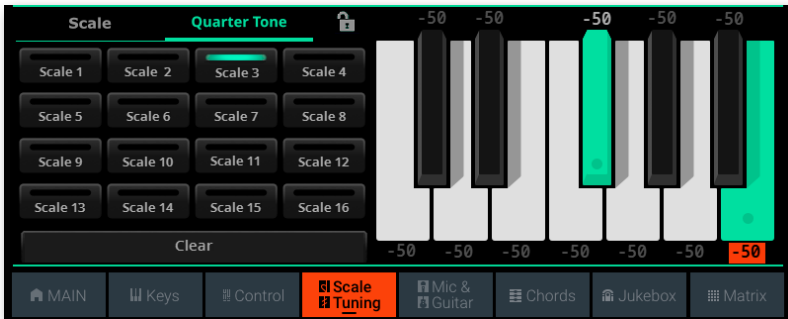

- > Touch the same **Scale** button to deactivate the selected scale.

■ Use the Quarter Tone sub-scale

- > Touch any note in the scale diagram whose pitch you want to lower, making it turn green (selected).
- > Touch the note again to make it return white, and reset to standard tuning.

Scale alterations made in this page are momentary and are not memorized. They is only meant to allow for quick scale alteration while playing.

■ Deactivate the Quarter Tone sub-scale

- > Touch the **Scale** tab on top of the pane. The **Scale Preset** buttons will disappear. The main scale will be in use again.

Choosing a Scale Preset by using a button or footswitch

You can select a Scale Preset by assigning it to a switch or footswitch.

- > Go to the **Settings > Menu > Controllers > Sliders/Buttons** page, and assign the **Quarter Tone** function to one of the **CONTROL** buttons when in User mode.
- > Go to the **Settings > Menu > Controllers > Foot** page, and assign the desired Scale Preset to the footswitch.

Please note that programming an assignable switch will tie the Scale Preset selection to a particular Keyboard Set, Style's Keyboard Set, or SongBook Entry. This means that you can prepare it for a particular song, requiring a particular scale.

On the contrary, programming the footswitch or a Control button will offer a global option, that will not change when choosing a different Keyboard Set, Style or SongBook Entry.

Editing the Scale Presets

Quarter Tone scales (Scale Presets) are custom scales where detuning can be activated or deactivated while playing. Changing note tuning while playing is typical of Turkish and Middle East/Arabic music. The detuned interval is usually next to a quarter tone.

You can save up to sixteen Quarter Tone scales into the Scale Presets. The Scale Presets are global and do not change with Keyboard Sets, Styles or Songs.

■ Program a Quarter Tone scale

- 1 Go to the **Settings > Menu > Tuning > Scale/Tune** page.

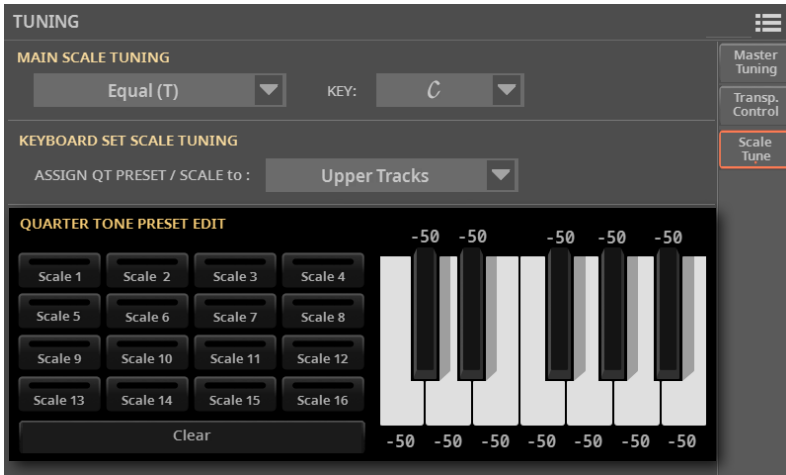

- 2 Touch one of the **Scale** buttons to choose a **Scale Preset** to be edited.

When no preset is selected, a default scale is automatically recalled. This scale assigns a -50 cent value (equivalent to a quarter tone down) to all the notes, and turns all scale degrees off. With no keys pressed, it is equivalent to the Equal tuning.

3 Program the **User Quarter Tone** sub-scale.

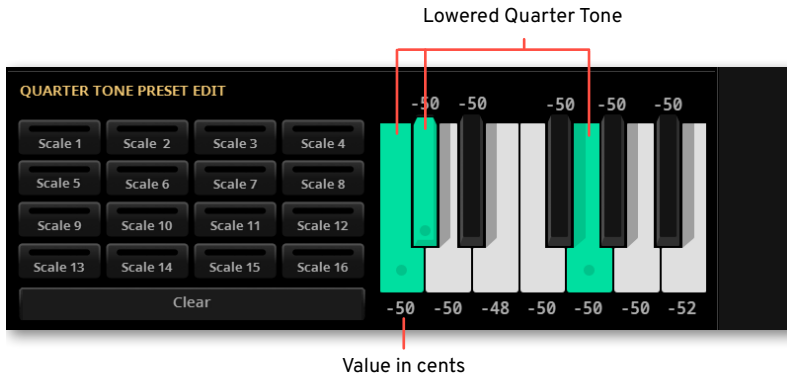

- > Touch one of the **keys** in the scale diagram to lower the corresponding scale degree by -50 cents (equivalent to one quarter tone). Touch it again to return to the standard tuning.
- > Use the **numbers** appearing next to each note of the keyboard diagram to fine tune each note pitch. Detuning is referred to Equal tuning considered as 'zero detune'.

Detuning

Meaning

-99 ... +99

Note detuning in cents or a semitone. Zero is no detuning, ± 50 is a full quarter tone up or down, ± 99 is nearly one whole semitone up or down.

■ Save the new Quarter Tone sub-scale into a Scale Preset

1 Choose the **Save Tuning Preset** command from the **page menu** (☰) to open the **Save Tuning Preset** dialog.

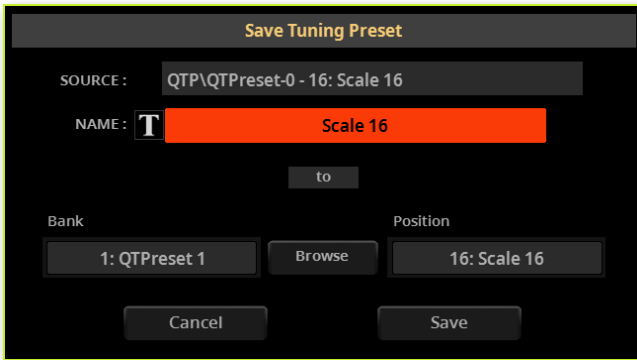

2 Touch the **Text Edit** (T) button if you want to assign the Scale Preset a new name. When done editing the name, confirm by touching the **OK** button under the virtual keyboard.

3 Choose one of the **Scale Preset** locations to save the new scale, then confirm by touching the **OK** button.

Realtime Quarter Tone

To make realtime tuning changes faster, you can assign the Quarter Tone function to an assignable switch, a footswitch, or a Control button. This will make those sudden scale changes, typical of the Turkish and Middle East/Arabic music, quick and easy.

Since these realtime changes are not saved anywhere, the scale is easily ‘wiped-out’ when selecting a different Keyboard Set, or when pressing the Quarter Tone switch again.

Programming a switch, button or footswitch as the Quarter Tone switch

- > Go to the **Home > Menu > Switches > Switches** page, and assign the **Quarter Tone** function to one of the assignable switches.
- > Go to the **Settings > Menu > Controllers > Sliders/Buttons** page, and assign the **Quarter Tone** function to one of the **CONTROL** buttons when in User mode.
- > Go to the **Settings > Menu > Controllers > Foot** page, and assign the **Quarter Tone** function to the footswitch.

Please note that programming an assignable switch will tie the Quarter Tone function to a particular Keyboard Set, Style’s Keyboard Set, or SongBook Entry. This means that you can program them for a particular song, requiring a particular scale.

On the contrary, programming the footswitch or a Control button will offer a global option, that will not change when choosing a different Keyboard Set, Style or SongBook Entry.

Using the Quarter Tone function

1 If you want to check what is happening, go to the **Home > Scale/Tuning** pane, and select the **Quarter Tone** view.

In any case, the Quarter Tone function will be activated even if you are in any other page.

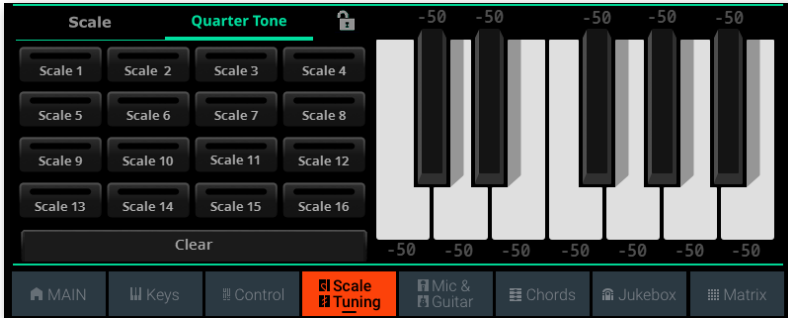

2 Lower some note pitches.

Keep the Quarter Tone switch, button or footswitch pressed. The keyboard will not play at this time. Press the notes whose pitch you want to lower. Release the switch, button or footswitch.

The detuned notes will appear in green in the keyboard diagram.

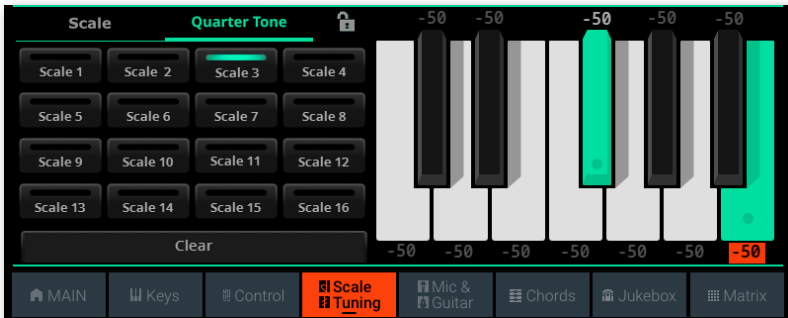

3 Play with your new scale. The pitch of the notes you have pressed are now lowered.

4 Reset the original scale.

Press and release the Quarter Tone switch, button or footswitch again, without playing any note. All the pitches will be reset, and the original scale will be recalled.

20

Controllers

User settings for the Control sliders and buttons

Using the sliders and buttons

The sliders and the buttons in the **CONTROL** section are always accessible, whichever the page you are in.

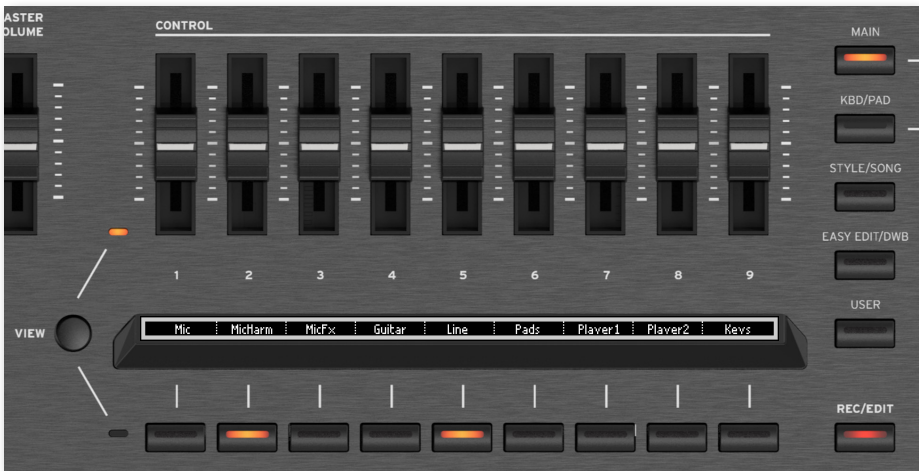

The way they work is chosen via the **mode buttons** on the right of the controls. How they work is explained in the dedicated section at the beginning of the manual. For more information see [The Control section](#) on page 111.

The **User** mode controls the parameters that you are free to assign to the sliders and the buttons. This is a global setting, that is automatically saved.

Programming the sliders and buttons

You can program a set of User Controls, accessed when in **USER** mode.

- 1 Go to the **Settings > Menu > Controllers > Sliders/Buttons** page.

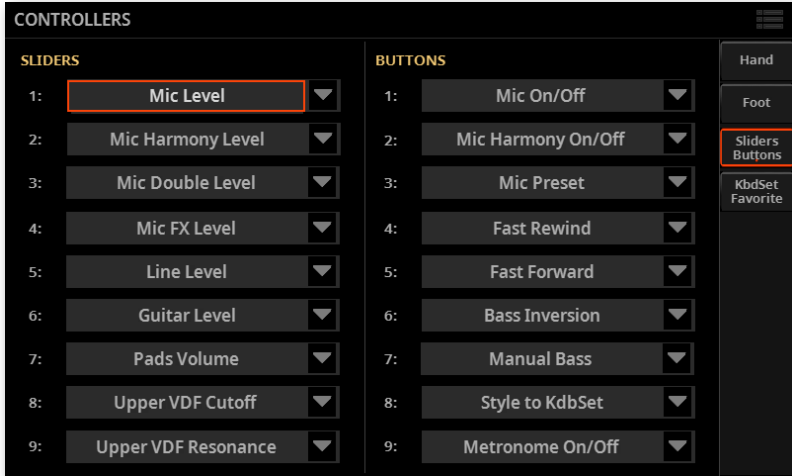

- 2 Use the pop-up menus to program the **Sliders** and the **Buttons**.

For a list of the assignable controls, see [Assignable functions](#) on page 486.

Assignable Switches

Programming the assignable switches

Assigning a function to the assignable switches

You can program the **ASSIGNABLE SWITCHES** in a different way for each Keyboard Set. Choosing a different set of Sounds may therefore also change the controls assigned to these switches, to match the different types of Sounds.

- 1 Go to the **Home > Menu > Switches** page.

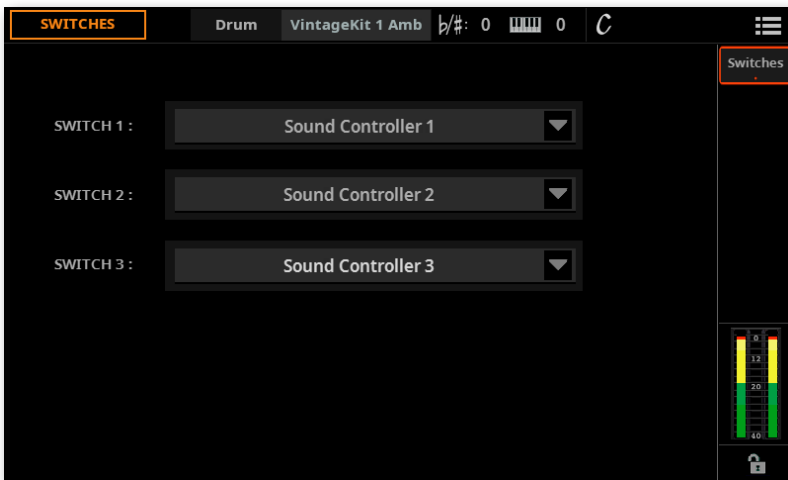

- 2 Use one of the **Switch 1...3** menus to choose a command to be assigned to the corresponding switch.
- 3 Save the changes to a Keyboard Set.
- 4 If you want the programming is not changed when choosing a different Keyboard Set, close the **lock** (🔒) in the lower-right corner of the page.

For a list of the assignable controls, see [Functions assignable to the buttons and footswitches](#) on page 489.

Using the assignable switches

Depending on the chosen Keyboard Set and the assigned functions, these controllers can do different things. With the DNC Sounds, the switches can either 'book' a function, that will be triggered while playing, or enable (or disable) it by pressing the button to 'toggle' it. In other cases, these switches can 'toggle' or 'trigger' the assigned function.

Indicator status	Meaning
Off	No DNC function assigned.
Purple steady	Booking DNC function available.
Purple blinking	Booking DNC function waiting to be executed. Then, it will return steady.
Light green steady	Toggle DNC function available.
Light green blinking	Toggle activated. Press it again to disable it.

Hand controllers

Programming the joystick

Assigning functions to the joystick

The **left/right (X-, X+)** movement of the joystick usually controls **Pitch Bend**. It can, however, control a **Sound parameter**, depending on the Sound programming.

The **up/forward movement (Y+)** is usually **Modulation**, and sometimes a different **Sound parameter**, depending on the Sound programming. The **down/backward movement (Y-)** can be assigned to **various controls**, or is left unused.

Assigning Sound parameters to the joystick can be done in **Sound Edit**.

Assigning the joystick to the Sounds

You can activate/deactivate the Joystick on each Keyboard Sound.

- 1 Go to the **Home > Menu > Keyboard/Ensemble > Joystick/Pedal** page.

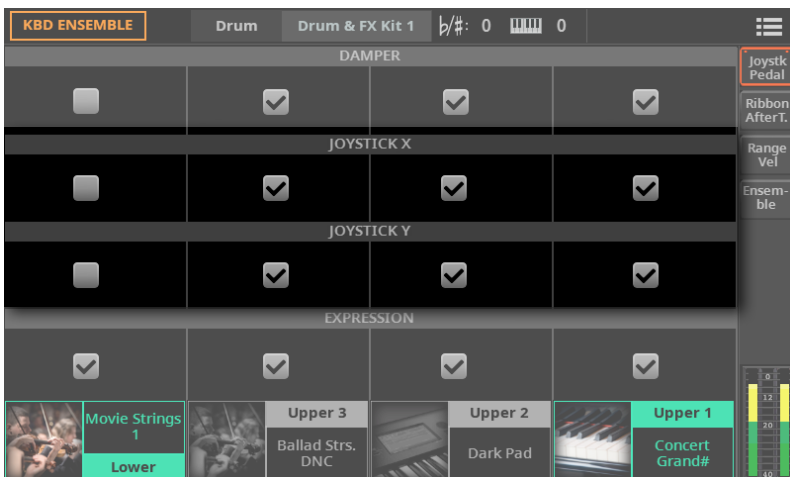

- 2 Use the **Joystick X** checkbox to turn the left/right Joystick movements on/off on each Sound.
- 3 Use the **Joystick Y** checkbox to turn the up/down Joystick movements on/off on each Sound.
- 4 Save the changes to a Keyboard Set.

Setting the Pitch Bend range

The Pitch Bend range is defined for each combination of Sounds, and can change with different Keyboard Sets, Styles, MIDI Songs or SongBook Entries.

- 1 Go to the **Home > Menu > Mixer/FX > Bend/Tuning** page.
- 2 Use the **Bend** knobs to set the Pitch Bend range for each Sound.

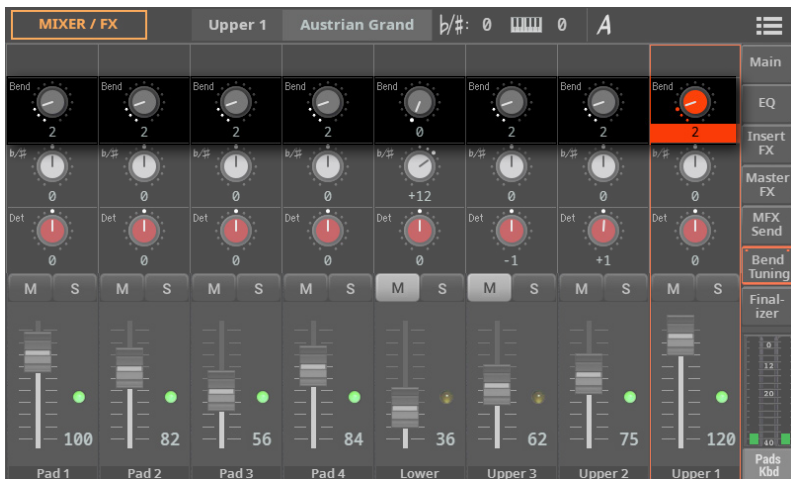

Bend

Meaning

0	No pitch bend allowed.
1 ... 12	Maximum up/down pitch bend range (in semitones). 12 = ± 1 octave.

- 3 Save the changes to a Keyboard Set, a Style, a MIDI Song or a SongBook Entry.

Programming the keyboard's Velocity and After Touch

Assigning functions to Velocity and After Touch

Velocity usually controls the Sound's **loudness**, while **After Touch** controls **modulation**. However, they can be assigned to other roles by each individual Sound. Assigning Sound parameters can be done in **Sound Edit**.

Assigning After Touch to the Sounds

You can activate/deactivate After Touch on each Keyboard Sound.

- 1 Go to the Home > Menu > **Keyboard/Ensemble** > **Ribbon/After Touch** page.

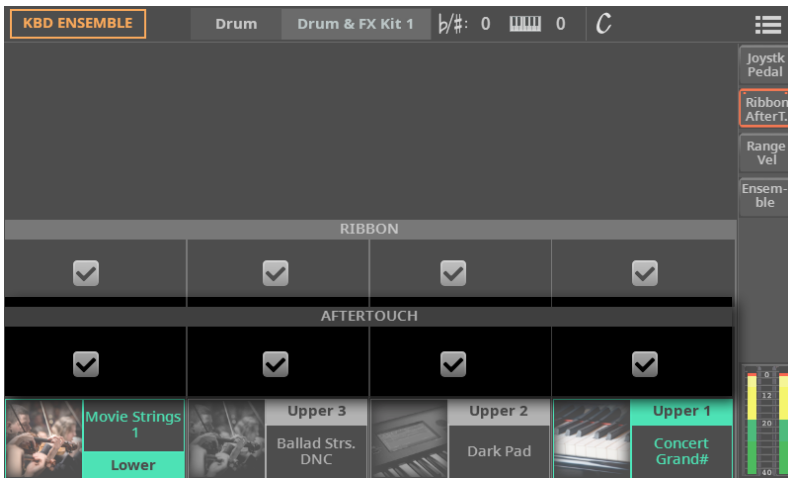

- 2 Use the **After Touch** checkbox to turn the After Touch on/off on each Keyboard Sound.
- 3 Save the changes to a Keyboard Set.

Adjusting the Velocity and After Touch sensitivity

You can define how the keyboard responds to your striking velocity and After Touch pressure.

- 1 Go to the **Settings > Menu > Controllers > Hand** page.
- 2 Use the **Velocity Curve** parameter to set the sensitivity of the keyboard to your playing strength.

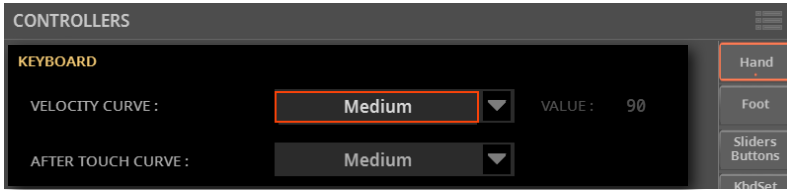

Velocity Curve

Meaning

Fixed	No dynamic control available. Dynamic values are fixed, as in classic organs. When this option is chosen, you can set the fixed velocity value.
Soft3 ... Hard3	Curves, from the lightest one to the hardest one.

- 3 Use the **After Touch Curve** parameter to set the sensitivity of the keyboard to the pressure you apply after playing a key.

After Touch Curve

Meaning

Soft3 ... Hard3	Curves, from the lightest one to the hardest one.
Off	The After Touch is turned off.

Programming the ribbon controller

Assigning functions to the ribbon controller

The function controlled by the ribbon depends on the selected Sounds. Assigning Sound parameters to the ribbon controller can be done in **Sound Edit**.

Assigning the ribbon controller to the Sounds

You can activate/deactivate the ribbon on each Keyboard Sound.

- 1 Go to the **Home > Menu > Keyboard/Ensemble > Ribbon/After Touch** page.

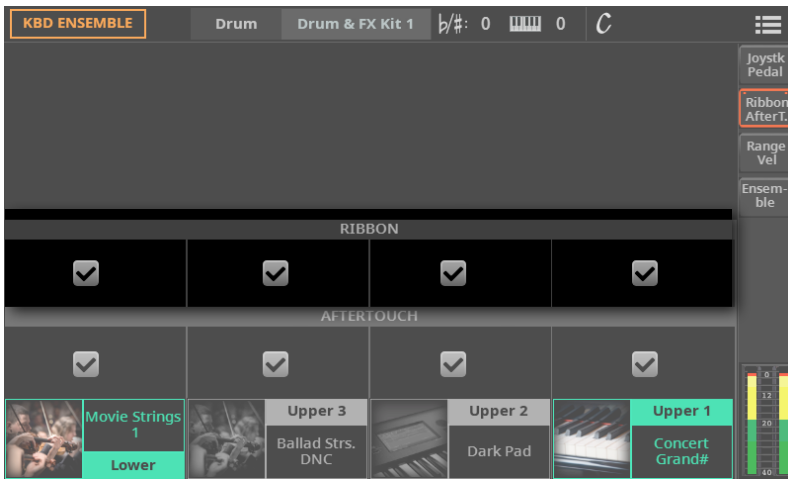

- 2 Use the **Ribbon** checkbox to turn the ribbon on/off on each Sound.
- 3 Save the changes to a Keyboard Set.

Adjusting the ribbon controller's sensitivity

You can define how sensitive is the ribbon controller to your finger's swipe.

- 1 Go to the **Settings > Menu > Controllers > Hand** page.

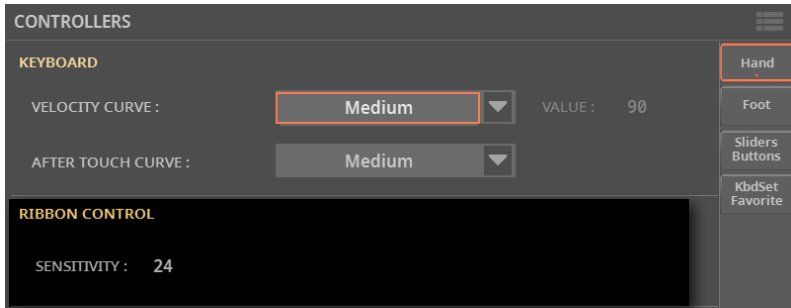

- 2 Use the Ribbon > **Sensitivity** parameter to set the ribbon's response.

Foot controllers

Programming the Damper pedal

You can connect a footswitch, or a dedicated damper pedal, to the **PEDAL > DAMPER** connector on the back of the instrument. This pedal always works as a Damper pedal.

Assigning the Damper pedal to the Sounds

You can activate/deactivate the damper pedal on each Keyboard Sound. This is useful, for example, to only sustain some Upper Sounds and not the others.

- 1 Go to the **Home > Menu > Keyboard/Ensemble > Joystick/Pedal** page.

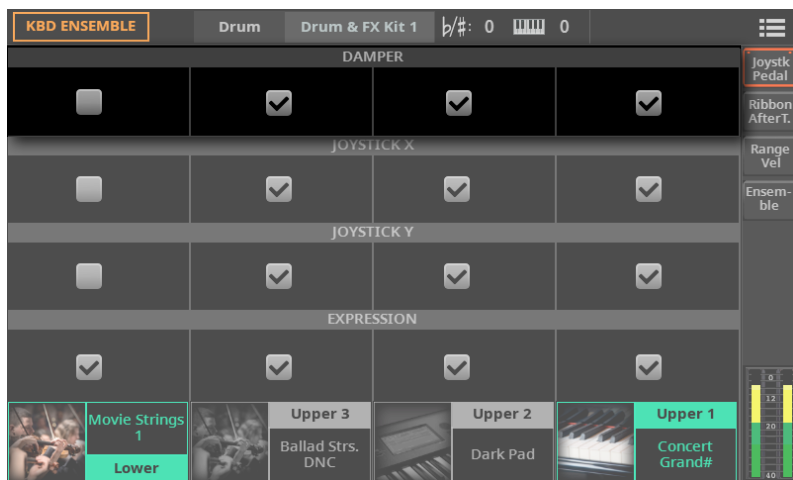

- 2 Use the **Damper** checkbox to turn the Damper pedal on/off on each Keyboard Sound.
- 3 Save the changes to a Keyboard Set.

Programming the pedals/footswitches

Assigning a function to the pedals/footswitches

You can connect a footswitch or expression pedal to each of the two **PEDAL > ASSIGNABLE** connectors on the back of the instrument. Depending on the connected type of pedal, you will choose a suitable function.

- 1 Connect the pedal or footswitch to one of the **PEDAL > ASSIGNABLE** connectors.
- 2 Go to the **Settings > Menu > Controllers > Foot** page.

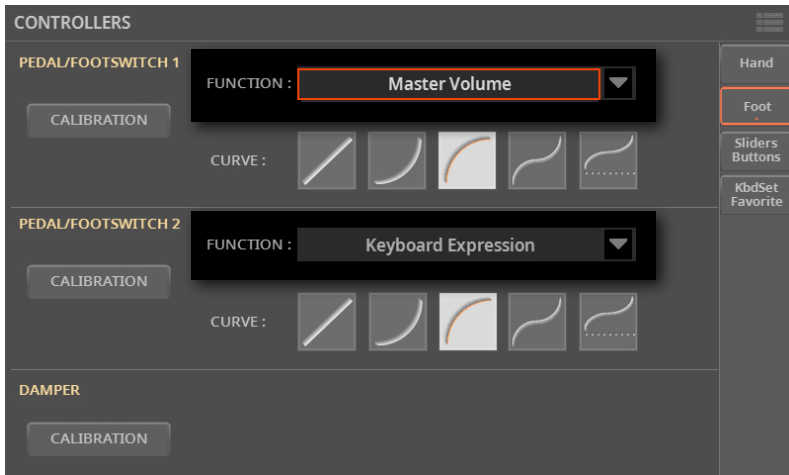

- 3 Use the **Function** pop-up menu to choose a control function.

For a list of the assignable controls, see [Assignable functions](#) on page 486.



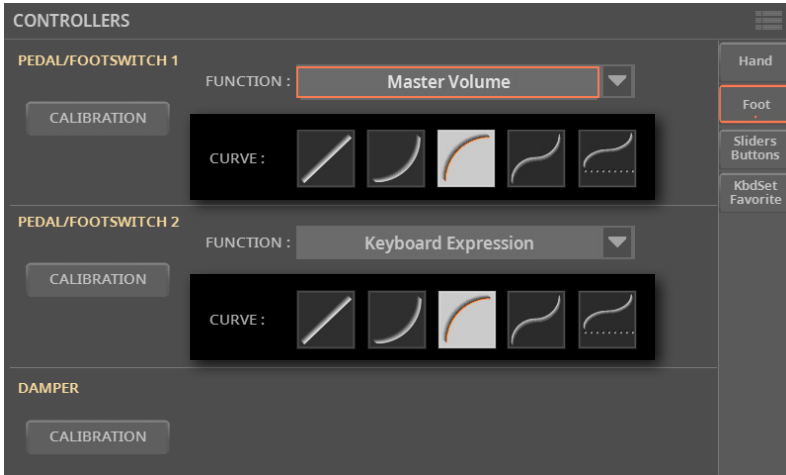

Choosing a curve presets for the expression pedal

With some functions assigned to an expression pedal, you can choose a curve, shaping the response of the function to the pedal.

- 1 Be sure to have connected an expression pedal, calibrated it, and selected a function.
- 2 Go to the **Settings > Menu > Controllers > Foot** page.



- 3 Touch one of the **Curve** buttons to select a curve preset.

Curve	Meaning
	Linear response.
	Exponential response. The function value will change faster toward the top of the pedal range.
	Logarithmic response. The function value will change slower toward the top of the pedal range.
	S-shaped response. The function value will change faster toward the bottom and the top of the pedal range, and will be smoother in the middle.
	S-shaped with offset response. As the previous one, but starting from a value higher than zero.

Assigning the Expression pedal to the Sounds

Expression is a relative level control, always subtracted from the Volume value. It can be assigned to any continuous pedal (also called a Volume/Expression pedal).

As an example, imagine you have a Piano sound assigned to Upper 1, and a Strings sound assigned to Upper 2. If you turn the Expression switch on on Upper 2, and off on Upper 1, you can use a continuous pedal to control only the Strings' volume, while the Piano's volume remains unchanged.

- 1 Go to the **Home > Menu > Keyboard/Ensemble > Joystick/Pedal** page.

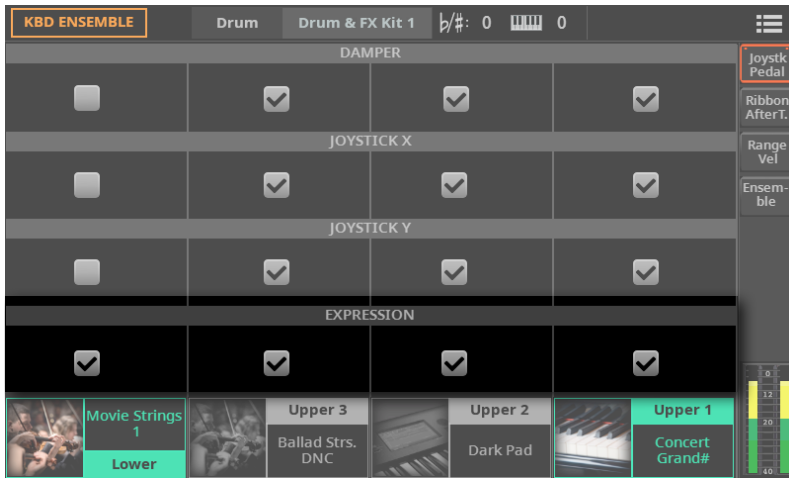

- 2 Use the **Expression** checkbox to turn the Expression pedal on/off on each Keyboard Sound.
- 3 Save the changes to a Keyboard Set.

Calibrating the pedals and setting their polarity

If needed, you might have to calibrate the pedals to use their full range of values, without any ‘dead spot’. Also, this procedure allows to choose a pedal’s polarity, in case you are using a pedal working in reverse.

- 1 Go to the **Settings > Menu > Controllers > Foot** page.

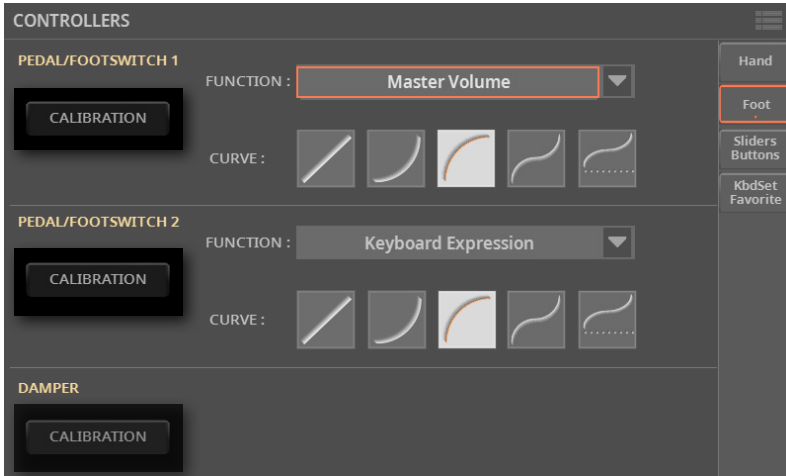

- 2 Touch the **Calibration** button in the area of the pedal to calibrate, to make the **Pedal/Footswitch Calibration** dialog appear.

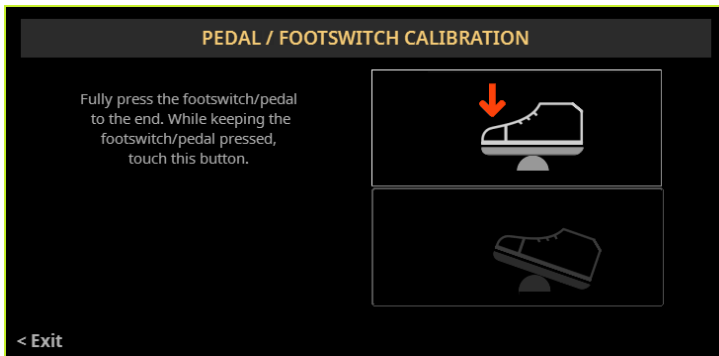

- 3 Fully press the pedal down, and while continuing to press touch the **top** (highlighted) button to confirm the maximum value.

- 4 When the following dialog appears, release the pedal.

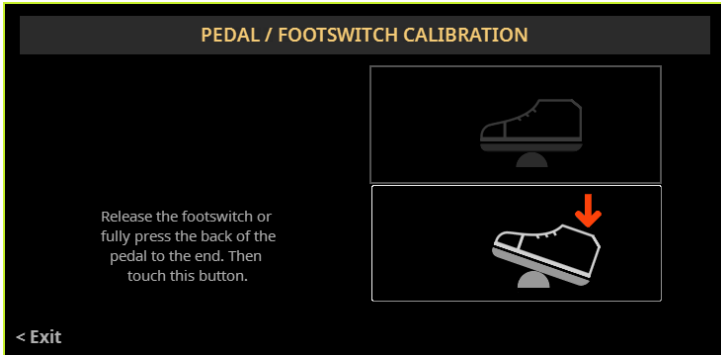

- 5 Touch the **lower** (now highlighted) button in the display to confirm the minimum value. Check if the pedal is working properly. In case it isn't, repeat the procedure.
- 6 Press the **EXIT** button to return to the previous page.

Assignable functions

Functions assignable to the sliders and continuous pedals

The following are the functions assignable to the **sliders** of the **CONTROL** section (**CTL**) and to the **volume/expression pedals** (**PDL**).

Continuous function	Meaning	CTL	PDL
Off	No function assigned.	✓	✓
Volume			
Master Volume	Master Volume control.	✓	✓
Keyboard Expression	Volume of the Keyboard Sounds relative to the general volume.	✓	✓
KbdSet Volume	Volume of all the Keyboard Sounds.	✓	
Kbd Upper 1...3 Volume	Volume of the corresponding Keyboard Sound.	✓	
Kbd Lower Volume		✓	
Player 1 Volume	Volume of Player 1.	✓	✓
Player 2 Volume	Volume of Player 2.	✓	✓
Pads Volume	Volume of the Pads.	✓	✓
Pad 1..4 Volume	Volume of the corresponding Pad.	✓	
Style Drum&Perc.Vol. (Gbl)	Volume of the Style's Drum & Percussion tracks.	✓	
Style Bass Vol. (Gbl)	Volume of the Style's Bass tracks.	✓	
Style Accomp.Vol. (Gbl)	Volume of the Style's Accompaniment tracks.	✓	✓
Track 1...8 Volume	Volume of the corresponding MIDI Song track.	✓	

Continuous function	Meaning	CTL	PDL	
Track 9/Sty Bass Volume	Volume of the corresponding MIDI Song or Style track.	✓		
Track 10/Sty Drum Volume		✓		
Track 11/Sty Perc Volume		✓		
Track 12/Sty Acc 1 Volume		✓		
Track 13/Sty Acc 2 Volume		✓		
Track 14/Sty Acc 3 Volume		✓		
Track 15/Sty Acc 4 Volume		✓		
Track 16/Sty Acc 5 Volume		✓		
Audio In controls				
Mic Level	Main Volume of the Mic input.	✓	✓	
Mic Lead Level	Level of the Lead Voice.	✓	✓	
Mic Delay/Reverb Level	Level controls for the Mic FXs.		✓	
Mic FX Level			✓	
Mic Harmony Level	Level of the Harmony effect.	✓	✓	
Mic Double Level	Level controls for the Mic FXs.	✓	✓	
Mic Filter Level		✓	✓	
Mic Mod Level		✓	✓	
Mic Delay Level		✓	✓	
Mic Reverb Level		✓	✓	
Mic EQ Gain Low		Mic EQ controls.	✓	
Mic EQ Gain Mid			✓	
Mic EQ Gain High			✓	
Guitar Level	Continuous controls assigned to the Guitar Processor.	✓	✓	
Guitar Preset FX1 Level		✓	✓	
Guitar Preset FX2 Level		✓	✓	
Guitar Preset FX3 Level		✓	✓	
Guitar Preset FX4 Level		✓	✓	
Line Level	Volume of the Line Input.	✓	✓	

Continuous function	Meaning	CTL	PDL
Joystick simulation			
Joystick X+	Replicates the joystick movement to the right.		✓
Joystick X-	Replicates the joystick movement to the left.		✓
Joystick Y+	Replicates the joystick forward movement.		✓
Joystick Y-	Replicates the joystick backward movement.		✓
Sound parameters			
Upper VDF Cutoff	Filter cutoff (for the Upper Sounds).	✓	✓
Upper VDF Resonance	Filter resonance (for the Upper Sounds).	✓	✓
FX parameters			
FX CC12 Ctrl	Standard FX controllers, used as DMS modulations.	✓	✓
FX CC13 Ctrl	How they work depends on the Effects programming.	✓	✓

Functions assignable to the buttons and footswitches

The following are the functions assignable to the **buttons** of the **CONTROL** section (**CTL**), to the **ASSIGNABLE SWITCHES (ASW)** and to the **footswitches (FSW)**.

Switch function	Meaning	CTL	ASW	FSW
Off	No function assigned	✓	✓	✓
Keyboard				
Split	Turns the Split on/off.			✓
Memory	Turns the Memory function on/off.			✓
Ensemble	Turns the Ensemble function on/off.			✓
Kbd Set 1...4	Selects the corresponding Keyboard Set from the KEYBOARD SET section under the X-FADER.			✓
Kbd Set Up	Selects the next Style's Keyboard Set from the KEYBOARD SET section under the X-FADER.			✓
Kbd Set Down	Selects the previous Style's Keyboard Set from the KEYBOARD SET section under the X-FADER.			✓
Style to Kbd Set	Makes the first Keyboard Set be selected when choosing a Style.	✓	✓	✓
Upper 1...3 Sound Sel	Opens the Sound Select window for the corresponding Upper Sound.	✓	✓	✓
Lower Sound Sel	Opens the Sound Select window for the Lower Sound.	✓	✓	✓
Sound Up	When a Sound is selected, chooses the next one in the list.	✓	✓	✓
Sound Down	When a Sound is selected, chooses the previous one in the list.	✓	✓	✓
Players				
Play Player 1	Starts the Style or Song assigned to Player 1.			✓
Play Player 2	Starts the Style or Song assigned to Player 2.			✓
Stop Player 1	Stops the Style or Song assigned to Player 1. The Song returns to the beginning.			✓
Stop Player 2	Stops the Style or Song assigned to Player 2. The Song returns to the beginning.			✓
Synchro Start	Make the Player start or stop when playing something on the keyboard.			✓
Synchro Stop				✓
Fade In/Out	Starts or stops the Player(s) with a smooth fade.			✓

Switch function	Meaning	CTL	ASW	FSW
Fast Forward	Moves forward the selected song.	✓	✓	
Fast Rewind	Moves backward the selected song.	✓	✓	
Jukebox Previous	Selects the previous Jukebox entry.	✓	✓	
Jukebox Next	Selects the next Jukebox entry.	✓	✓	
Style				
Intro 1...3/Count In	Selects the corresponding Intro.			✓
Ending 1...3	Selects the corresponding Ending.			✓
Fill 1...4	Selects the corresponding Fill.			✓
Break	Selects the Break.			✓
Variation 1...4	Selects the corresponding Variation.			✓
Variation Up	Selects the next Variation.			✓
Variation Down	Selects the previous Variation.			✓
Manual Bass	Let's you freely play the bass on the keyboard.	✓	✓	✓
Bass Inversion	Makes the bass note be recognized when you play an inverted chord.	✓	✓	✓
Bass&Lower Backing	When the Style is not playing and the keyboard is in Split mode, you can play the Lower Sound with your left hand, while the Bass still plays the chord root.	✓	✓	✓
Chord Latch	Holds the recognized chord until the pedal is released.			✓
Chord Sequence				
Chord Seq. Record	Starts recording a Chord Sequence.			✓
Chord Seq. Play	Starts playing a Chord Sequence.			✓
Pads				
Pad 1...4 Sel	Opens the Pad Select window for the corresponding Pad.	✓	✓	✓
All Pads On/Off	Starts/Stops all the Pads.	✓	✓	✓
Pad 1..4	Starts/Stops the corresponding Pad.			✓
Tempo and Metronome				
Tap Tempo/Reset	Sets the Tempo value by 'tapping' it on the assigned controller.			✓
Tempo Lock	Prevents the Tempo value from changing.			✓
Tempo Up	Change the Tempo value.			✓
Tempo Down				✓

Switch function	Meaning	CTL	ASW	FSW
Ritardando	Slowing down or making the Tempo faster, according to the curves programmed in the Settings > General Controls > Basic page.	✓	✓	✓
Accelerando		✓	✓	✓
Metronome On/Off	Turns the Metronome on/off.	✓	✓	✓
Transpose				
Transpose (#)	Transposes the instrument one semitone down or up.			✓
Transpose (b)				✓
Upper Octave Up	Transposes the Upper Sounds one octave down or up.			✓
Upper Octave Down				✓
Scale and Tuning				
Quarter Tone	Turns Quarter Tone function on/off.	✓	✓	✓
Quarter Tone Preset 1...16	Selects one of the presets shown in the Home > Scale/Tuning > Quarter Tone pane.			✓
Mixer				
Track Select	While in a page where all the tracks are shown, switches between the Pads/Kbd and the Style view, and between the Pads/Kbd, Song 1-8 and Song 9-16 view.	✓	✓	
Tracks Mute and Solo				
Kbd Upper 1...3 Mute	Mute/unmute the corresponding Sound.			✓
Kbd Lower Mute				✓
Track 1...8 Mute	Mute/Unmute the corresponding MIDI Song track.	✓	✓	✓
Track 9/Sty Bass Mute	Mute/Unmute the corresponding MIDI Song or Style track.	✓	✓	✓
Track 10/Sty Drum Mute		✓	✓	✓
Track 11/Sty Perc Mute		✓	✓	✓
Track 12/Sty Acc 1 Mute		✓	✓	✓
Track 13/Sty Acc 2 Mute		✓	✓	✓
Track 14/Sty Acc 3 Mute		✓	✓	✓
Track 15/Sty Acc 4 Mute		✓	✓	✓
Track 16/Sty Acc 5 Mute		✓	✓	✓
Drum&Bass Mode	Mutes all the Style or MIDI Song tracks, except for the Bass and Drum tracks (as set in the Settings > Preference > Song page). It doesn't work on MP3 Songs.	✓	✓	✓
Solo Selected Track	Turns track solo on/off.	✓	✓	✓

Switch function	Meaning	CTL	ASW	FSW
Melody/Voice Remover	Mutes the melody track in a MIDI Song, or removes the lead voice from a MP3 Song. (A track can be set as the Melody track in the Settings > Preferences > Song page).	✓	✓	✓
Lyrics				
Text Page Up	These options let you move to the previous or next page, when reading a text file automatically loaded with a Song or SongBook Entry, or manually loaded from the Lyrics page.	✓	✓	✓
Text Page Down		✓	✓	✓
SongBook				
Set List Next	Selects the next SongBook Entry in the selected Set List.	✓	✓	✓
Set List Prev	Selects the previous SongBook Entry in the selected Set List.	✓	✓	✓
Pedals				
Damper Pedal	Damper function. Corresponds to the right pedal of an acoustic piano. It holds the notes played when the pedal is pressed down.			✓
Soft Pedal	Soft function. Corresponds to the 'una corda' pedal of an acoustic piano. Makes the sound softer.			✓
Sostenuto Pedal	Sostenuto function. Corresponds to the left pedal of a grand piano. It holds the notes already held when pressing the pedal down.			✓
Glide	When the pedal is pressed, affected notes on Upper tracks are bent down, according to settings for the Pitch Bend on the same tracks. When the pedal is released, notes return to the normal pitch, at the speed defined in the Settings > General Controls > Basic page.			✓
Audio In On/Off and FX				
Mic On/Off	Turns the Microphone input on/off.	✓	✓	✓
Mic Lead Mute	Mutes the Lead voice.	✓	✓	✓
Mic Talkover	Turns the Mic Talkover function on/off.	✓	✓	✓
Mic Filter On/Off	Turns the Mic Processor Filter section on/off.	✓	✓	✓
Mic Mod On/Off	Turns the Mic Processor Mod section on/off.	✓	✓	✓
Mic Delay On/Off	Turns the Mic Processor Delay section on/off.	✓	✓	✓
Mic Harmony On/Off	Turns the Mic Processor Harmony section on/off.	✓	✓	✓
Mic Double On/Off	Turns the Mic Processor Double section on/off.	✓	✓	✓
Mic Reverb On/Off	Turns the Mic Processor Reverb section on/off.	✓	✓	✓

Switch function	Meaning	CTL	ASW	FSW
Guitar On/Off	Turns the Guitar input on/off.	✓	✓	✓
Guitar FX1 On/Off	Turns the Guitar Processor FX1 section on/off.	✓	✓	✓
Guitar FX2 On/Off	Turns the Guitar Processor FX2 section on/off.	✓	✓	✓
Guitar FX3 On/Off	Turns the Guitar Processor FX3 section on/off.	✓	✓	✓
Guitar FX4 On/Off	Turns the Guitar Processor FX4 section on/off.	✓	✓	✓
Line In On/Off	Turns the Lin input on/off.	✓	✓	✓
Mic and Guitar Presets				
Mic Preset	Opens the Mic Preset Select window.	✓	✓	✓
Guitar Preset	Opens the Guitar Preset Select window.	✓	✓	✓
Drawbars				
Rotor Brake On/Off	Triggers the Rotary Speaker's Brake (rotary speaker stopping).	✓	✓	✓
Rotary Spkr Fast/Slow	Switches between the Rotary Speaker's Fast and Slow rotation speed.	✓	✓	✓
Drawbars Perc On/Off	Turns the Drawbar Percussion on/off.	✓	✓	✓
Drawbars Perc Harmonic	Turns the Drawbar Percussion Harmonic on/off.	✓	✓	✓
Drawbars Leakage	Turns the Drawbar Leakage on/off.	✓	✓	✓
Drawbars Key On	Turns the Drawbar Key On noise on/off.	✓	✓	✓
Drawbars Key Off	Turns the Drawbar Key Off noise on/off.	✓	✓	✓
Drawbars Overdrive	Turns the Drawbar Overdrive on/off.	✓	✓	✓
Sound and FX parameters				
Sound Controller 1...3	DNC Sound Controllers (CC#80, CC#81 and CC#82). They control the function assigned in Sound Edit in DNC Sounds.	✓	✓	✓
FX CC12 Switch	Standard FX switches. How they work depends on the Effects programming.	✓	✓	✓
FX CC13 Switch		✓	✓	✓

Additional programming

Setting the Accelerando/Ritardando times

Accelerando and Ritardando are controls you can assign to an assignable switch or footswitch. When the switch is pressed, Tempo will start gradually speeding up or down.

- 1 Go to the **Settings > Menu > General Controls > Basic** page.

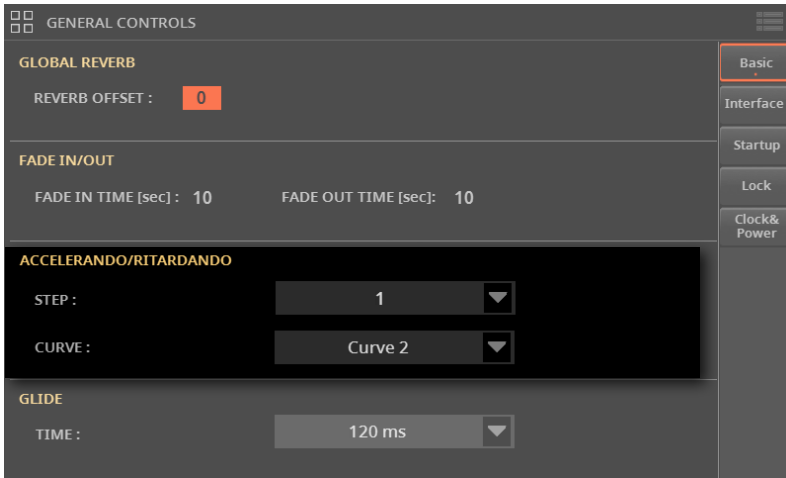

- 2 Use the **Accelerando/Ritardando > Step** parameter to set the speed of Tempo change (from 1 to 6).

With higher values, the step change will be greater, and the speed will change faster. With lower values, the step change will be smaller, and the speed will change more slowly.

- 3 Use the **Accelerando/Ritardando > Curve** parameter to set the curve of Tempo change (from 1 to 3).

Experiment the various options, to see the one that best fits your taste.

Setting the Glide time

Glide is a control you can assign to a footswitch. When the footswitch is pressed, affected notes on the Upper parts are bent down, according to the Pitch Bend settings. When the footswitch is released, the notes return to the normal pitch, at the speed defined by the **Glide Time** parameter.

■ Change the Pitch Bend values

- 1 Go to the **Home > Menu > Mixer/FX > Bend/Tuning** page.

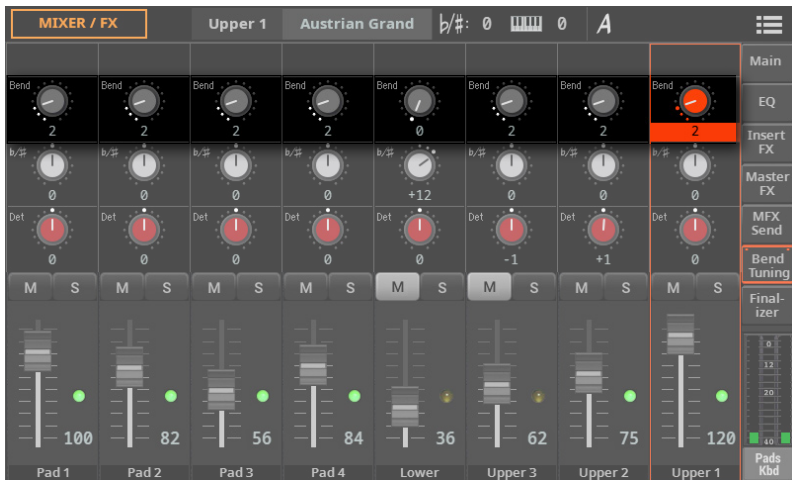

- 2 Use the **Bend** parameter to set the Pitch Bend range (in semitones).
- 3 Save the changes to a Keyboard Set.

■ Change the Glide time

- 1 Go to the **Settings > Menu > General Controls > Basic** page.

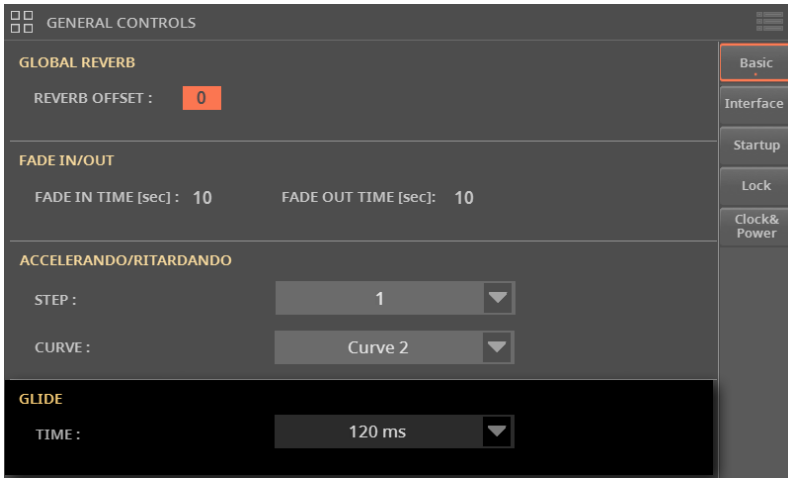

- 2 Use the **Glide > Time** parameter to set the time needed to return to the standard pitch.

21

MIDI

Introduction to MIDI

Ports, channels, messages

What is MIDI?

MIDI stands for **Musical Instruments Digital Interface**. This interface lets you connect two (or more) musical instruments, or a computer and various musical instruments.

From a software point of view, MIDI is a protocol that describes messages for playing notes and controlling them. It is sort of a grammar to let different instruments and computers speak the same language, and let the one tell the other what to do.

From a physical point of view, MIDI messages travel across the classic **MIDI interface** or the **USB** port, a connector replacing the MIDI ports with a single port and cable. Personal computers, tablets and external controllers can be connected with a single USB cable.

Pa5X can be connected to a personal computer with no need of special software. However, for full and easy use of all its MIDI features, we suggest that you install the **KORG USB-MIDI Driver**, a special software that you can download from our web site (www.korg.com).

No audio signal is transmitted through MIDI. MIDI only consists of control messages.

Channels and messages

Basically, a MIDI or USB cable transmits **16 channels** of data. Think to each MIDI channel as a TV channel: the receiver must be set on the same channel of the transmitter. The same happens with MIDI messages: when you send a Note On message on channel #1, it will be received on channel #1 only. This allows the instruments to be multitimbral: you can have more than one sound playing on the same MIDI instrument – one for each MIDI channel.

There are various messages, but here are the most commonly used ones:

MIDI Message	CC#	Meaning
Note On		This message instructs an instrument to play a note on a specific channel. Notes have both a name (C4 standing for the center C) and a number (60 being the equivalent for C4). A Note Off message is used to say the note has been released. Together with the Note On message, a Velocity value is always sent. This value tells the instrument how loud the note must play.
Pitch Bend (PB)		You can generate this message acting on the joystick (X direction). The pitch is 'bent' up or down.
Program Change (PC)		When you select a Sound, a Program Change message is generated on the channel. Use this message, together with Control Change #00 and #32, to remotely select Pa5X data from a sequencer or a master keyboard.
Control Change (CC)		This is a wide array of messages, controlling most of the instrument parameters. Some examples:
Bank Select MSB	00	This message pair is used to select a Sound Bank. Together with the Program Change message, they are used to select a Sound.
Bank Select LSB	32	
Modulation	01	This is the equivalent of pressing up the joystick. A vibrato effect is usually triggered on.
Volume	07	Use this controller to set the channel's volume.
Pan	10	This one sets the channel's position on the stereo front.
Expression	11	Use this controller to set the relative volume of a track, with the maximum value matching the current setting of the CC07 control.
Damper Pedal	64	Use this control to simulate the Damper pedal.

Tempo

Tempo is a global MIDI message, that is not tied to a particular channel. Each MIDI Song includes Tempo data.

Lyrics

Lyric Meta Events are intended to display text together with the music. Pa5X can read many of the available Lyrics format on the market.

MIDI standards

Standard MIDI Files

Standard MIDI Files (abbreviated as SMF) are a practical way of exchanging songs between different instruments and computers. Pa5X uses the SMF format as its default MIDI Song format, so reading a song from a computer, or saving a song that a computer software can read, is not a problem at all.

The internal Players are compatible with SMFs format 0 (all data in one track; it is the most common format) and 1 (multitrack). Pa5X can read SMFs from the Home page, and modify/save them in Song Edit mode. Songs are saved in SMF format 0.

Pa5X can also display SMF lyrics and chord abbreviations in various formats available on the market.

Standard MIDI Files usually have the .mid or .kar filename extension.

The General MIDI standard

In addition to the Standard MIDI File (SMF) format, the General MIDI Standard (GM) allows further standardization between musical instruments. This extension of the basic MIDI standard sets some basic rules for compatibility between instruments:

- > A minimum of 16 MIDI channels is required.
- > A basic set of 128 Sounds, correctly ordered, is mandatory.
- > The Drum Kit must follow a standard note configuration.
- > Channel 10 has to be devoted to the Drum Kit.

Pa5X is compatible with the GM1 and GM2 standards.

The XG™ standard

Pa5X is compatible with the Sounds and Drum Kits of the XG standard.

Global, Control and Chord channels

The Control channel

You can set a MIDI IN channel as the Control channel (in the **Settings > Menu > MIDI > MIDI IN Channels** page), to select Styles, Keyboard Sets and SongBook Entries from an external device (see the [Appendix](#) for a list of messages corresponding to the internal data of Pa5X). On this channel you can also send controls to start/stop the Players, and select the Style Elements (see later in this part).

A MIDI OUT channel set as the Control channel (set in the **Settings > Menu > MIDI > MIDI OUT Channels** page) can be used to send messages when selecting SongBook Entries.

The Global channel

Any MIDI channel can be set as a Global channel (in the **Settings > Menu > MIDI > MIDI IN Channels** page), and can simulate the Pa5X integrated keyboard. When Pa5X is connected to a master keyboard, transmission should usually take place over the Global channel of Pa5X.

MIDI messages received over a Global channel are affected by the status of the **SPLIT** button, as well as by the split point. Therefore, if the **SPLIT** button's indicator is lit up, notes arriving to Pa5X over this channel will be divided by the split point into the Upper (above the split point) and Lower (below the split point) parts.

Notes received on a Global channel are used for the chord recognition of the automatic accompaniment. If the **SPLIT** indicator is turned on, only the notes below (Lower scan mode) or above (Upper scan mode) the split point will be used.

The Chord 1 and Chord 2 channels

Two Chord channels (programmed in the **Settings > Menu > MIDI > MIDI IN Control** page) can be used to receive notes for the chord recognition. These notes will be combined with the notes received on the Global channel.

Contrary to the Global channel, the Chord channels are not affected by the split point. However, the status of the **SPLIT** button will change the way chords are recognized on the Chord channels:

Split status	Chord Recognition mode
On	Decided by the Chord Recognition parameter of the Settings > Menu > Preferences > Style page. You can play a single note to play a Major chord.
Off	Always Fingered or Expert, depending on the previous situation. You have to play at least three notes in order for the chord to be detected.

These two channels are especially useful for accordion players, that want to use a separate Chord channel for the chords, and another one for the bass played with the left hand. This way, chords and bass will both contribute to the chord recognition for the automatic accompaniment.

Connecting MIDI devices

Connecting to another device: an overview

You can use either the **MIDI** or **USB** ports to connect Pa5X to other devices. When a USB port is available, it is the easier (therefore preferred) connection.

After connecting to the other device, you can quickly configure Pa5X by choosing one of the supplied MIDI Presets. Or you can manually program all the MIDI parameters, and maybe save them into a new custom MIDI Preset.

Connecting Pa5X to a personal computer or tablet

You can use the **USB DEVICE** port to connect Pa5X to a personal computer or tablet. As an alternative, connect them through the **MIDI IN** and **OUT** connectors and a dedicated MIDI interface on the computer.

Connecting Pa5X to an external controller

You can use the **MIDI IN** port to connect external controllers (master keyboard, MIDI guitar, wind controller, MIDI accordion...) to Pa5X. You can also use the **USB HOST** port for a simpler connection to an external controller, like the KORG **nano** or **micro** series.

Connecting Pa5X to additional musical instruments

You can use the **MIDI OUT** port to connect additional musical instruments (for example, your preferred vintage sound expander) to be controlled from Pa5X.

What are the various connectors used for

- > Use the **USB DEVICE** port to communicate with a computer or tablet. Connect it to the other device's USB port (Type-A, sometimes named **TO DEVICE**).
- > Use the **USB HOST** port to receive data from an external controller. Connect it to the controller's USB port (Type-B, sometimes named **TO HOST**).
- > Use the **MIDI OUT** port to send MIDI data to another musical instrument or computer. Connect it to the other device's **MIDI IN** port.
- > Use the **MIDI IN** port to receive MIDI data from a controller or computer. Connect it to the other device's **MIDI OUT** port.

To know how to match Sounds and MIDI channels, see [Programming the MIDI channels](#) on page 533.

Connecting Pa5X to a personal computer or tablet

You can program a new song on a personal computer or tablet connected to Pa5X. The computer has to run sequencing or notation software. When a song is ready, you can transfer it to the internal drive of Pa5X, and read it with the internal Players.

Connection and settings

- 1 Install the KORG USB MIDI Driver, as explained in the following pages.
- 2 Connect Pa5X and the computer or tablet via the **USB DEVICE** port.



- 3 On the computer, activate the **MIDI Thru** function (please refer to the software's user manual).
- 4 In Pa5X, go to the **Settings > Menu > MIDI > General Controls** page and choose one of the **Player** or **Tablet** MIDI Preset.

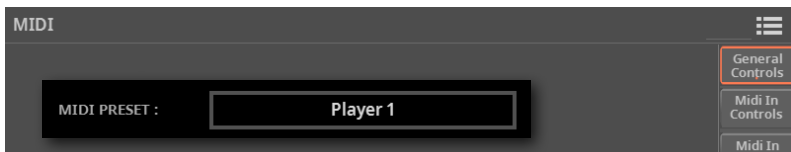

5 Still in the **Settings > Menu > MIDI > General Controls** page, deselect the **Local Control** checkbox to put the instrument in the **Local Off** status.

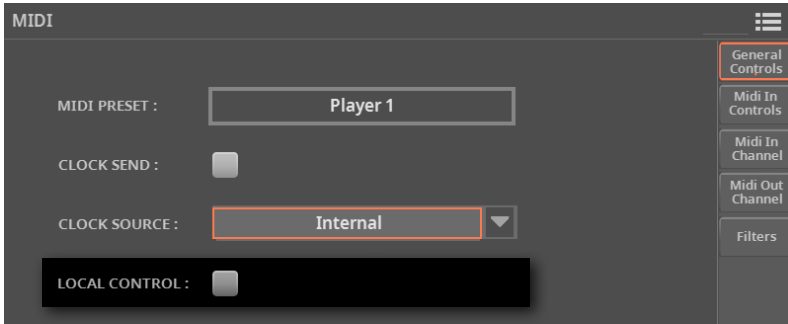

6 Press the **EXIT** button to return to the **Home** page.

7 Play the keyboard.

Notes played on the keyboard will go from the USB port of Pa5X to the USB port of the computer or tablet. Notes generated by the computer are sent from the USB port of the computer to the USB port of Pa5X.

The Sounds

The song that is played back by the external sequencer can select Pa5X Sounds through the MIDI messages Bank Select MSB, Bank Select LSB (bank selection, two messages), and Program Change (Sound selection). See the list of Sounds and corresponding MIDI values in the [Appendix](#).

As a hint for people programming songs on a computer: even through this is not mandatory, for maximum compatibility you should set Bass on channel #2, Melody on channel #4, Drum Kit on channel #10, controls for the Harmonizer on channel #5.

Connecting Pa5X to an external controller

You can control Pa5X with an external master controller, like a KORG synthesizer, a controller of the KORG *micro* or *nano* series, a digital piano, a wind or breath controller, a MIDI pedalboard, guitar or accordion. These devices allow for complete replacement of the internal keyboard, or for adding new controllers to play some of the Sounds while still using the internal keyboard. Some of the controllers allow for easier mixing, or for playing percussions and special effects on a dedicated device.

Connection through the USB HOST port

If your controller has a USB port, you can use it to connect it to Pa5X.

- > Connect the **USB HOST** port (Type-A) of Pa5X to the **USB** port of the master controller (Type-B, sometimes named **TO HOST**).

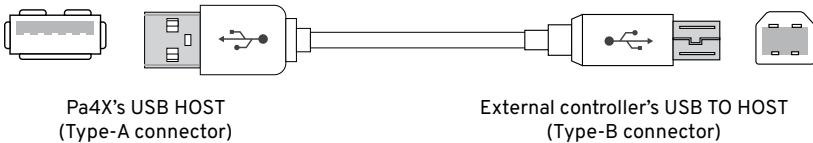

Connection through the MIDI ports

If your controller has a MIDI interface, you can use it to connect it to Pa5X.

> Connect the **MIDI OUT** port of the master controller to the **MIDI IN** port of Pa5X.

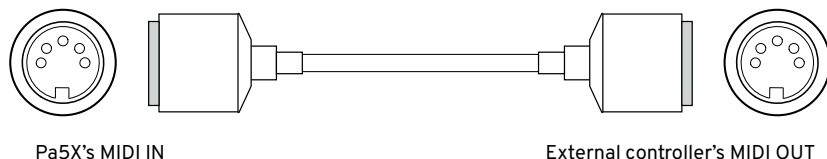

Setting the MIDI channels

■ Program the master controller

Match the MIDI channel(s) on which the master controller will send data with those on which Pa5X will receive data.

- 1 In the master controller, set the MIDI channel(s) on which data will be transmitted. Usually, channel #1 is the default setting.
- 2 If the master controller also includes a sound generator, set it to the Local Off status, to prevent it from sounding its own sounds and Pa5X's sounds at the same time on the same channel(s).

■ Program Pa5X

Configure the MIDI channels on Pa5X.

- 1 Go to the **Settings > Menu > MIDI** pages.
- 2 Either choose a MIDI Preset, or manually program the MIDI IN channels.
 - > If a MIDI Preset matching your type of connection exists, go to the **Settings > Menu > MIDI > General Controls** page and use the **MIDI Preset** pop-up menu to choose the MIDI Preset.

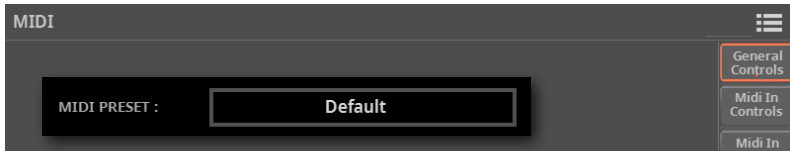

- > If no MIDI Preset matches your type of connection, go to the **Settings > Menu > MIDI > MIDI IN Channel** page and set the MIDI channels to match the incoming data. You can start from an existing MIDI Preset with some of the programming already set to your needs.

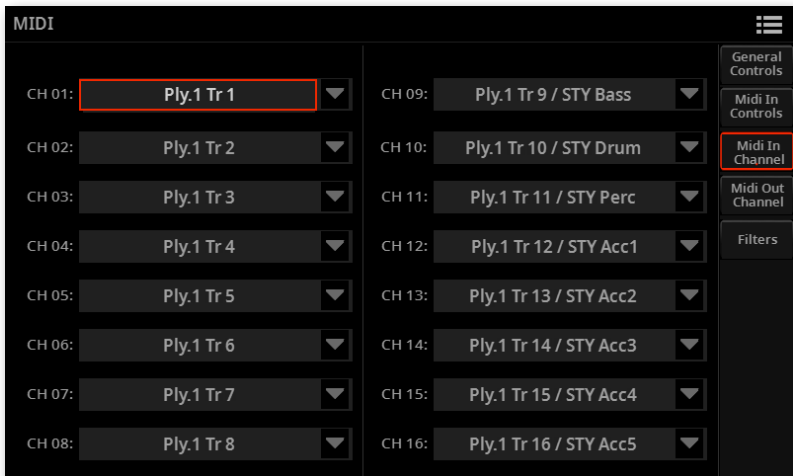

> If needed, go to the **Settings > Menu > MIDI > Filters** page and set the MIDI filters. Some MIDI Presets may include filters that you have to deactivate, or you may need to filter out some types of data.

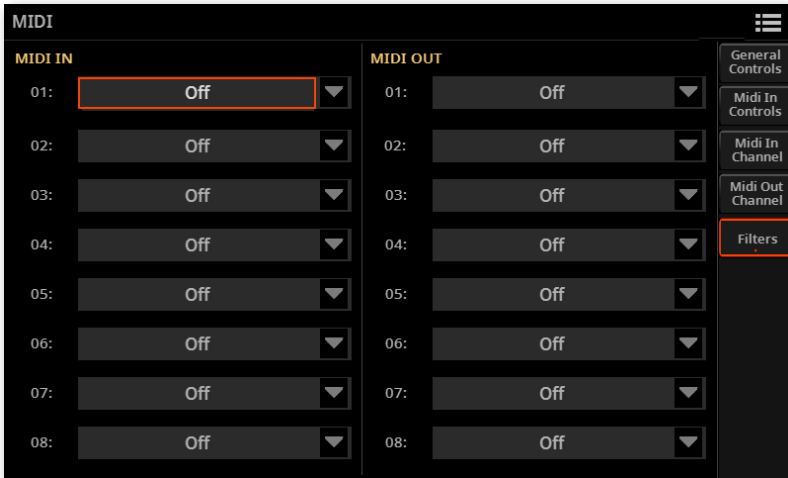

> You might also want to check the parameters in the **Settings > Menu > MIDI > General Controls** and **MIDI IN Controls** pages, to set things like MIDI Clock or transposition.

3 After having set the MIDI channels, the filters and any other data, you can save the new configuration into a new MIDI Preset, by choosing the **Save MIDI Preset** command from the **page menu** (☰).

Installing the KORG USB-MIDI Driver

The **USB DEVICE** port can be used for MIDI communication between Pa5X and a personal computer or tablet. Use a standard A-to-B USB cable to connect your instrument and computer. A dedicated software driver can be found in the Support area of our web site (www.korg.com).

KORG USB-MIDI Driver system requirements

Be sure your personal computer meets the requirements, as described in the documents accompanying the driver.

Copyright notice

Copyright to all software included in this product is the property of KORG Inc. The license agreement for this software is provided separately. You must read this license agreement before you install this software. Your installation of this software will be taken to indicate your acceptance of this agreement.

Installing the KORG USB-MIDI Driver on a Windows PC

Please connect Pa5X to the computer via a USB cable only after having installed the **KORG USB-MIDI Driver Tools**.

- 1 Double-click on **KORG USB-MIDI Driver Tools Setup v.n.nn.exe** to run the installer ('n.nn' meaning the version number).
- 2 Follow the instructions appearing on the screen. At the end, the tools will be installed.
- 3 When installation is completed, connect the **USB DEVICE** port of your Pa5X to one of the USB ports of your Windows PC by using a standard A-to-B USB cable. The Auto Installer will immediately start. Complete the installation procedure, and confirm (if needed).
- 4 When finished, Pa5X will be able to communicate with your computer via USB. You can access the tools and manuals from the **Start** menu.

Installing the KORG USB-MIDI Driver on a Mac

- 1 Double-click on **KORG USB- MIDI Driver v.n.n.n.dmg** to open a virtual drive in the Finder ('n.n.n.' meaning the version number).
- 2 Double-click on **KORG USB-MIDI Driver.pkg** to run the installer.
- 3 Follow the instructions appearing on the screen.
- 4 When installation is completed, eject the virtual drive, and connect the **USB DEVICE** port of your Pa5X to one of the USB ports of your Mac by using a standard A-to-B USB cable.

How Pa5X is seen from a MIDI application

After installation, the following ports will be shown in your MIDI application among the other MIDI devices:

Device	Meaning
Pa5X KEYBOARD	This allows for reception of MIDI messages from Pa5X (keyboard and controllers) to the MIDI application running on the computer.
Pa5X SOUND	This allows for transmission of MIDI messages from the MIDI application running on the computer, to the internal tone generator of Pa5X.

Quick setup using the MIDI Presets

Choosing a MIDI Preset

Connecting an instrument to a master keyboard, an external controller, a personal computer or a tablet, usually requires some programming. To help you configure the MIDI channels, we have provided some MIDI Presets, that will automatically configure the MIDI parameters according to your needs.

- 1 Go to the **Settings > Menu > MIDI > General Controls** page.

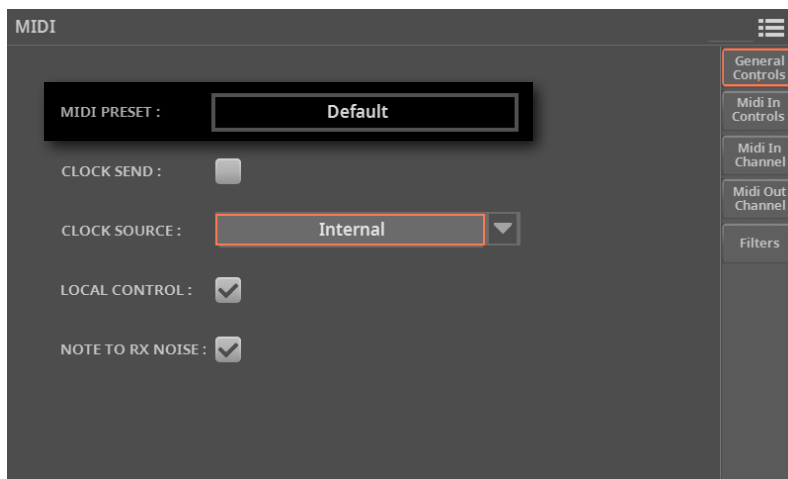

2 Touch the **MIDI Preset** button to open the **Select** window.

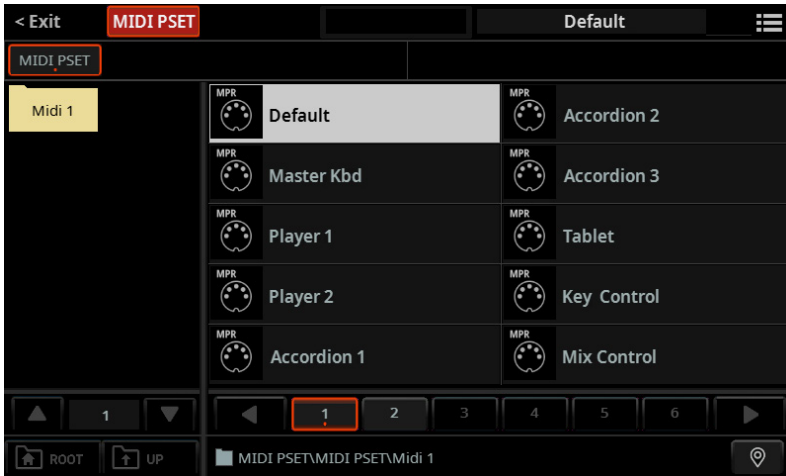

3 Browse through the files and folders, and choose one of the available **MIDI Presets**.

4 If you want to close the **Select** window (and it does not close by itself), press the **EXIT** button.

HINT: When a window does not close by itself, it means the **Display Hold** is turned on. See **Display Hold** on page 67.

5 The name of the selected preset will appear in the **MIDI Preset** field, and all the MIDI parameters will be automatically configured.

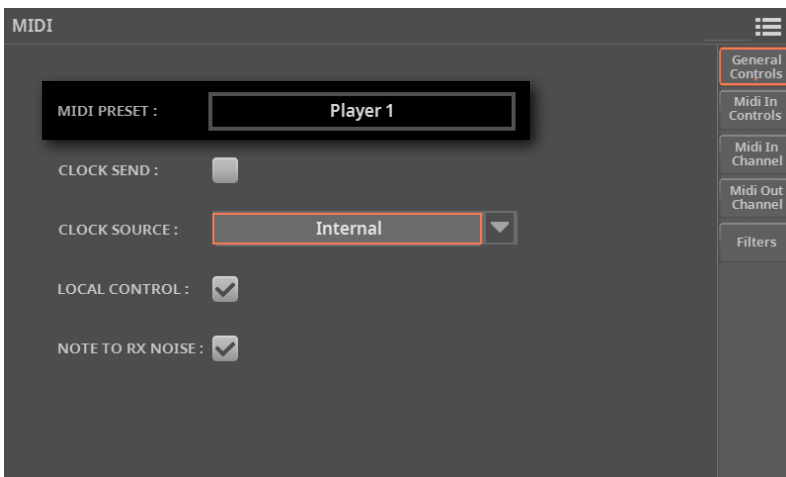

The MIDI Presets in detail

You will use the supplied MIDI Presets in the following cases:

MIDI Preset	Use
Default	Generic settings, good for most situations
Master Kbd	When connecting to an external master keyboard
Player 1	When using an external sound generator (an expander or a virtual instrument) driven by either Player 1 or Player 2. When programming a song on an external sequencer and Pa5X's Song Edit mode, and you want to use the much better sounds of Pa5X instead of the ones of the computer's internal generator.
Player 2	
Accordion 1	Play all the Upper parts with the right hand, the Lower part with the chord section, the Bass part with the bass section. Chords to the Style are sent with the chord+bass sections combined. If the selected Chord Scan mode is Upper or Upper+Lower, you can also play chords with the right hand.
Accordion 2	Play the Upper 1 part with the right hand, the Lower part with the chord section. Chords to the Style are sent with the chord+bass sections combined.
Accordion 3	Play the Upper 1 part with the right hand, the Lower part with the chord section, the Bass part with the bass section. Chords to the Style are sent from a single MIDI channel.
Tablet	When connecting to a tablet, to remotely select SongBook Entries, or send MIDI messages when selecting them.
Key Control	To play the Upper 3 Sound with an external keyboard.
Mix Control	To control the Volume and Pan of each Sound with an external controller.
Pad Control	To play percussive sounds or special effects (on the Upper 3) from an external set of pads. You can also use it to send chords to the internal arranger.
X/Y Control	To control two separate sound parameters on the Upper 1 with an external X/Y controller.
Studio Ctrl	To connect various controllers at the same time.
Breath Ctrl	To control one or more sound parameters on the Upper 1 with a breath controller.

Parameter	Default	Master Kbd	Tablet
MIDI IN Channel	1 Ply 1 Tr 1	Global	-
	2 Ply 1 Tr 2	Control	-
	3 Ply 1 Tr 3	-	-
	4 Ply 1 Tr 4	-	-
	5 Ply 1 Tr 5	-	-
	6 Ply 1 Tr 6	-	-
	7 Ply 1 Tr 7	-	-
	8 Ply 1 Tr 8	-	-
	9 Ply 1 Tr 9/Sty Bass	-	-
	10 Ply 1 Tr 10/Sty Drum	-	-
	11 Ply 1 Tr 11/Sty Perc	-	-
	12 Ply 1 Tr 12/Sty Acc1	-	-
	13 Ply 1 Tr 13/Sty Acc2	-	-
	14 Ply 1 Tr 14/Sty Acc3	-	-
	15 Ply 1 Tr 15/Sty Acc4	-	-
	16 Ply 1 Tr 16/Sty Acc5	-	Control
MIDI OUT Channel	1 Upper 1	Upper 1	-
	2 Upper 2	Upper 2	-
	3 Upper 3	Upper 3	-
	4 Lower	Lower	-
	5 -	-	-
	6 -	-	-
	7 -	-	-
	8 -	-	-
	9 -	-	-
	10 -	-	-
	11 -	-	-
	12 -	-	-
	13 -	-	-
	14 -	-	-
	15 -	-	-
	16 -	-	Control
Chord 1 Ch.	Off	1	Off
Chord 2 Ch.	Off	Off	Off
Mic Processor Ch.	5	5	5
Mic Processor Oct. Trp.	0	0	0
MIDI IN Up/Low Oct. Trp.	On	On	On
MIDI IN Velocity	Normal	Normal	Normal
MIDI IN Track Mute Active	-	On	On
MIDI Filters	All Off	SysEx In/Out	All Off

Parameter	Player 1	Player 2
MIDI IN Channel	1 Ply 1 Tr 1	Ply 2 Tr 1
	2 Ply 1 Tr 2	Ply 2 Tr 2
	3 Ply 1 Tr 3	Ply 2 Tr 3
	4 Ply 1 Tr 4	Ply 2 Tr 4
	5 Ply 1 Tr 5	Ply 2 Tr 5
	6 Ply 1 Tr 6	Ply 2 Tr 6
	7 Ply 1 Tr 7	Ply 2 Tr 7
	8 Ply 1 Tr 8	Ply 2 Tr 8
	9 Ply 1 Tr 9/Sty Bass	Ply 2 Tr 9/Sty Bass
	10 Ply 1 Tr 10/Sty Drum	Ply 2 Tr 10/Sty Drum
	11 Ply 1 Tr 11/Sty Perc	Ply 2 Tr 11/Sty Perc
	12 Ply 1 Tr 12/Sty Acc1	Ply 2 Tr 12/Sty Acc1
	13 Ply 1 Tr 13/Sty Acc2	Ply 2 Tr 13/Sty Acc2
	14 Ply 1 Tr 14/Sty Acc3	Ply 2 Tr 14/Sty Acc3
	15 Ply 1 Tr 15/Sty Acc4	Ply 2 Tr 15/Sty Acc4
	16 Ply 1 Tr 16/Sty Acc5	Ply 2 Tr 16/Sty Acc5
MIDI OUT Channel	1 Ply 1 Tr 1	Ply 2 Tr 1
	2 Ply 1 Tr 2	Ply 2 Tr 2
	3 Ply 1 Tr 3	Ply 2 Tr 3
	4 Ply 1 Tr 4	Ply 2 Tr 4
	5 Ply 1 Tr 5	Ply 2 Tr 5
	6 Ply 1 Tr 6	Ply 2 Tr 6
	7 Ply 1 Tr 7	Ply 2 Tr 7
	8 Ply 1 Tr 8	Ply 2 Tr 8
	9 Ply 1 Tr 9/Sty Bass	Ply 2 Tr 9/Sty Bass
	10 Ply 1 Tr 10/Sty Drum	Ply 2 Tr 10/Sty Drum
	11 Ply 1 Tr 11/Sty Perc	Ply 2 Tr 11/Sty Perc
	12 Ply 1 Tr 12/Sty Acc1	Ply 2 Tr 12/Sty Acc1
	13 Ply 1 Tr 13/Sty Acc2	Ply 2 Tr 13/Sty Acc2
	14 Ply 1 Tr 14/Sty Acc3	Ply 2 Tr 14/Sty Acc3
	15 Ply 1 Tr 15/Sty Acc4	Ply 2 Tr 15/Sty Acc4
	16 Ply 1 Tr 16/Sty Acc5	Ply 2 Tr 16/Sty Acc5
Chord 1 Ch.	Off	Off
Chord 2 Ch.	Off	Off
Mic Processor Ch.	5	5
Mic Processor Oct. Trp.	0	0
MIDI IN Up/Low Oct. Trp.	On	On
MIDI IN Velocity	Normal	Normal
MIDI IN Track Mute Active	-	-
MIDI Filters	All Off	All Off

Parameter	Accordion 1	Accordion 2	Accordion 3
MIDI IN Channel	1 Global	Upper 1	Upper 1
	2 Lower	Lower	Lower
	3 Ply 1 Tr 9/Sty Bass	-	Ply 1 Tr 9/Sty Bass
	4 -	Upper 2	Upper 2
	5 -	Upper 3	Upper 3
	6 -	-	-
	7 -	-	-
	8 -	-	-
	9 -	Ply 1 Tr 9/Sty Bass	-
	10 Ply 1 Tr 10/Sty Drum	Ply 1 Tr 10/Sty Drum	Ply 1 Tr 10/Sty Drum
	11 Ply 1 Tr 11/Sty Perc	Ply 1 Tr 11/Sty Perc	Ply 1 Tr 11/Sty Perc
	12 Ply 1 Tr 12/Sty Acc1	Ply 1 Tr 12/Sty Acc1	Ply 1 Tr 12/Sty Acc1
	13 Ply 1 Tr 13/Sty Acc2	Ply 1 Tr 13/Sty Acc2	Ply 1 Tr 13/Sty Acc2
	14 Ply 1 Tr 14/Sty Acc3	Ply 1 Tr 14/Sty Acc3	Ply 1 Tr 14/Sty Acc3
	15 Ply 1 Tr 15/Sty Acc4	Ply 1 Tr 15/Sty Acc4	Ply 1 Tr 15/Sty Acc4
	16 Ply 1 Tr 16/Sty Acc5	Ply 1 Tr 16/Sty Acc5	Ply 1 Tr 16/Sty Acc5
MIDI OUT Channel	1 Upper 1	Ply 1 Tr 1	Ply 1 Tr 1
	2 Upper 2	Ply 1 Tr 2	Ply 1 Tr 2
	3 Upper 3	Ply 1 Tr 3	Ply 1 Tr 3
	4 Lower	Ply 1 Tr 4	Ply 1 Tr 4
	5 -	Ply 1 Tr 5	Ply 1 Tr 5
	6 -	Ply 1 Tr 6	Ply 1 Tr 6
	7 -	Ply 1 Tr 7	Ply 1 Tr 7
	8 -	Ply 1 Tr 8	Ply 1 Tr 8
	9 -	Ply 1 Tr 9/Sty Bass	Ply 1 Tr 9/Sty Bass
	10 -	Ply 1 Tr 10/Sty Drum	Ply 1 Tr 10/Sty Drum
	11 -	Ply 1 Tr 11/Sty Perc	Ply 1 Tr 11/Sty Perc
	12 -	Ply 1 Tr 12/Sty Acc1	Ply 1 Tr 12/Sty Acc1
	13 -	Ply 1 Tr 13/Sty Acc2	Ply 1 Tr 13/Sty Acc2
	14 -	Ply 1 Tr 14/Sty Acc3	Ply 1 Tr 14/Sty Acc3
	15 -	Ply 1 Tr 15/Sty Acc4	Ply 1 Tr 15/Sty Acc4
	16 -	Ply 1 Tr 16/Sty Acc5	Ply 1 Tr 16/Sty Acc5
Chord 1 Ch.	2	2	2
Chord 2 Ch.	3	3	Off
Mic Processor Ch.	5	5	5
Mic Processor Oct. Trp.	0	0	0
MIDI IN Up/Low Oct. Trp.	On	On	On
MIDI IN Velocity	110	110	Normal
MIDI IN Track Mute Active	-	-	-
MIDI Filters	SysEx In/Out	SysEx In/Out	SysEx In/Out

Parameter	Key Control	Mix Control	Pad Control	
MIDI IN Channel	1	Upper 3	Ply 1 Pad 1	Upper 3
	2	-	Ply 1 Pad 2	-
	3	-	Ply 1 Pad 3	-
	4	-	Ply 1 Pad 4	-
	5	-	Lower	-
	6	-	Upper 3	-
	7	-	Upper 2	-
	8	-	Upper 1	-
	9	-	Ply 1 Tr9/Sty Bass	-
	10	-	Ply 1 Tr 10/Sty Drum	-
	11	-	Ply 1 Tr 11/Sty Perc	-
	12	-	Ply 1 Tr 12/Sty Acc1	-
	13	-	Ply 1 Tr 13/Sty Acc2	-
	14	-	Ply 1 Tr 14/Sty Acc3	-
	15	-	Ply 1 Tr 15/Sty Acc4	-
	16	-	Ply 1 Tr 16/Sty Acc5	-
MIDI OUT Channel	1	-	-	-
	2	-	-	-
	3	-	-	-
	4	-	-	-
	5	-	-	-
	6	-	-	-
	7	-	-	-
	8	-	-	-
	9	-	-	-
	10	-	-	-
	11	-	-	-
	12	-	-	-
	13	-	-	-
	14	-	-	-
	15	-	-	-
	16	-	-	-
Chord 1 Ch.	Off	Off	16	
Chord 2 Ch.	Off	Off	Off	
Mic Processor Ch.	5	5	5	
Mic Processor Oct. Trp.	0	0	0	
MIDI IN Up/Low Oct. Trp.	On	On	On	
MIDI IN Velocity	Normal	Normal	Normal	
MIDI IN Track Mute Active	-	-	-	
MIDI Filters	All Off	All Off	All Off	

Parameter	X/Y Control	Studio Control	Breath Control
MIDI IN Channel	1	Upper 1	Upper 1
	2	-	Upper 2
	3	-	Upper 3
	4	-	Lower
	5	-	Pad 1
	6	-	Pad 2
	7	-	Pad 3
	8	-	Pad 4
	9	-	Drum
	10	-	Percussion
	11	-	Bass
	12	-	Acc 1
	13	-	Acc 2
	14	-	Acc 3
	15	-	Acc 4
	16	-	Acc 5
MIDI OUT Channel	1	-	-
	2	-	-
	3	-	-
	4	-	-
	5	-	-
	6	-	-
	7	-	-
	8	-	-
	9	-	-
	10	-	-
	11	-	-
	12	-	-
	13	-	-
	14	-	-
	15	-	-
	16	-	-
Chord 1 Ch.	Off	Off	Off
Chord 2 Ch.	Off	Off	Off
Mic Processor Ch.	5	5	5
Mic Processor Oct. Trp.	0	0	0
MIDI IN Up/Low Oct. Trp.	On	On	On
MIDI IN Velocity	Normal	Normal	Normal
MIDI IN Track Mute Active	-	-	-
MIDI Filters	All Off	All Off	All Off

Editing the MIDI Presets

- 1 Choose a **MIDI Preset** containing programming similar to what you want to achieve.
- 2 While in the **Settings > Menu > MIDI** pages, edit the various parameters.

MIDI Presets can be considered as a starting point that can be freely tweaked. Once you have selected the most appropriate MIDI Preset for the connection to be made, you can modify the parameters as needed.

The parameters that will be saved to a MIDI Preset are the ones shown in the above table.

Saving a MIDI Preset

You can save a MIDI Preset, to create a library of quick settings for the different setups.

■ Open the Save MIDI Preset dialog

- 1 Go to the any page of the **Settings > MIDI** section.
- 2 Choose the **Save MIDI Preset** command from the **page menu** (☰). The **Save MIDI Preset** dialog will appear.

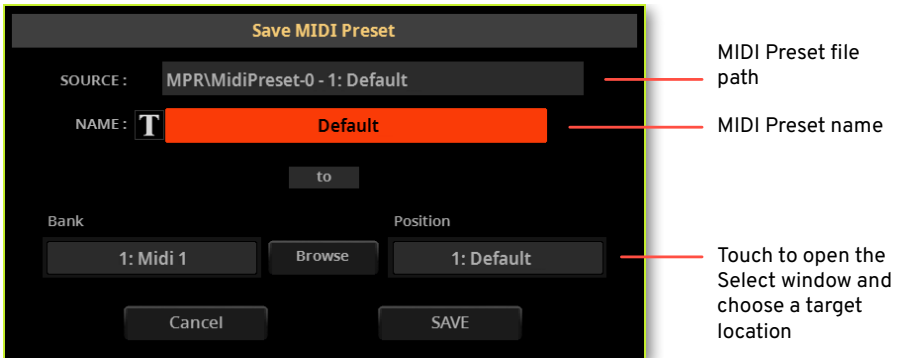

■ Rename the MIDI Preset

While in the **Save MIDI Preset** dialog, you may change the **name** of the MIDI Preset.

- 1 Touch the **Text Edit** (T) button to open the **virtual keyboard** and edit the name.
- 2 When done editing the name, confirm by touching the **OK** button under the virtual keyboard.

■ Save over the same MIDI Preset

- > If you want to overwrite the current MIDI Preset, just touch the **Save** button.

■ Save to a different MIDI Preset location

- 1 If you want to save to a different location, touch the **Browse** button to open the **Select** window.
- 2 Touch the folder where you want to save the new MIDI Preset. Don't touch any of the existing MIDI Preset names, unless you want to overwrite them!

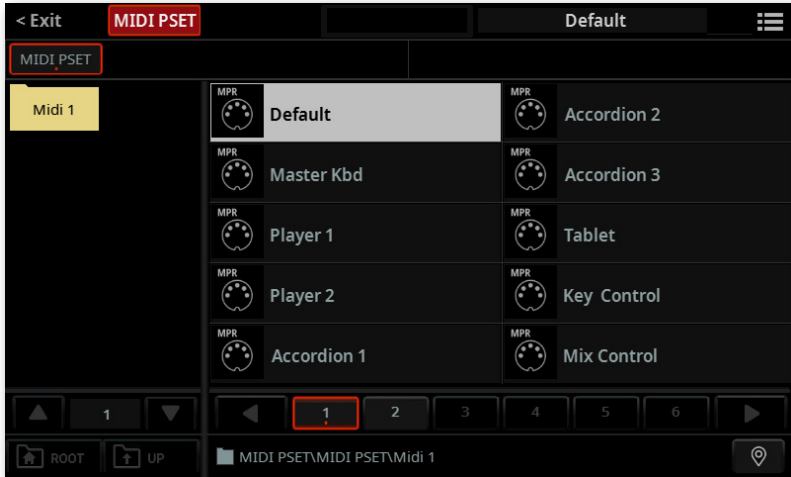

- 3 Find an empty location, shown as three hyphens ('---'), and touch it.

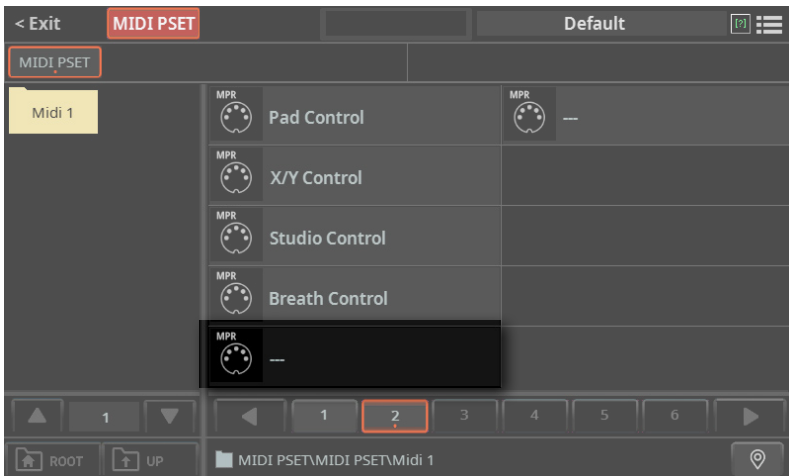

- 4 Press the **EXIT** button to close the **Select** window and confirm your selection.
- 5 When back at the **Save MIDI Preset** dialog, confirm the Save operation by touching the **Save** button.

Synchronizing with other instruments

Sending the MIDI Clock

The selected Player can send a MIDI Clock (Tempo synchronization) message to the other devices.

- 1 Go to the **Settings > Menu > MIDI > General Controls** page.

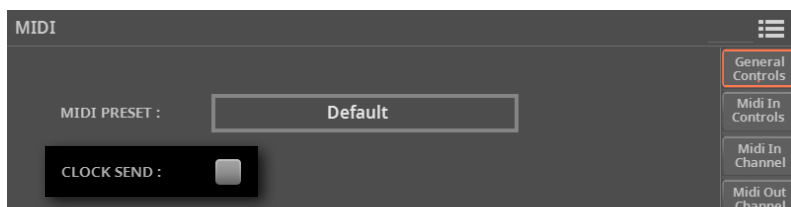

- 2 Select the **Clock Send** checkbox to send the internal MIDI Clock to the **MIDI IN** and **USB** ports.

When the MIDI Clock signal is sent, you can make another instrument play at the same Tempo of Pa5X, and be controlled by its Play/Stop commands.

Receiving the MIDI Clock

The Players can receive MIDI Clock (Tempo synchronization) messages from an external device.

- 1 Go to the **Settings > Menu > MIDI > General Controls** page.

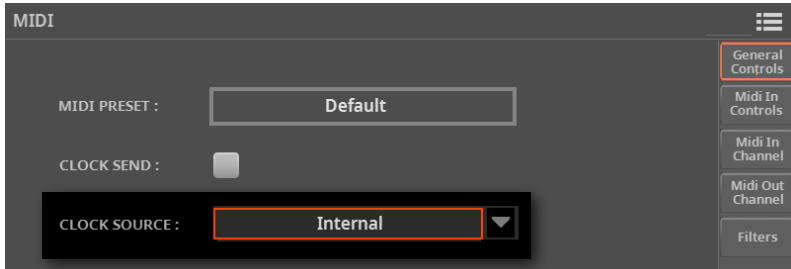

- 2 Use the **Clock Source** pop-up menu to choose a MIDI Clock source for the internal Players.

Clock Source	Meaning
Internal	MIDI Clock is generated by Pa5X's internal Players.
External MIDI	MIDI Clock is received from the MIDI IN or USB port.
External USB	

This parameter is automatically set to **Internal** each time the instrument is turned on.

Routing, processing and transposing

Connecting the keyboard to the internal or external sounds

The 'local' controls (keyboard, physical controllers) can be connected to the internal sounds directly, or echoed back from an external device.

- 1 Go to the **Settings > Menu > MIDI > General Controls** page.

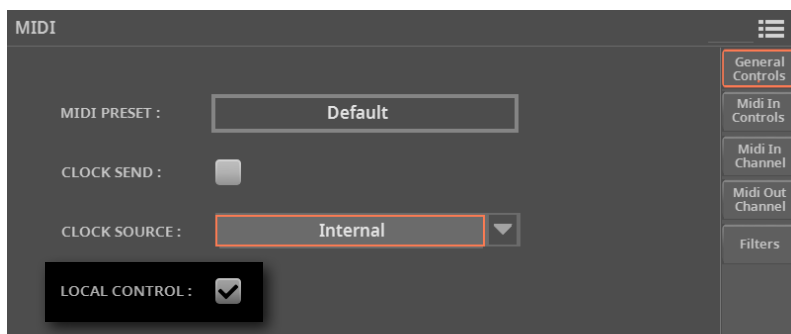

- 2 Use the **Local Control** parameter to connect or disconnect the keyboard and controllers to the internal sounds.

Local Control	Meaning
On	When you play the keyboard, MIDI data are sent to the internal sound generator. If Sounds are assigned to a MIDI OUT channel, data are also sent to the MIDI OUT and USB ports.
Off	The keyboard is connected to the MIDI OUT and USB ports, but cannot play the internal sound generator. This is very useful when working with an external sequencer, to send notes and various MIDI messages from the integrated keyboard and controllers to the external sequencer, and then let the sequencer send them back to the sound generator, without overlapping and MIDI echo effects.

This parameter is automatically activated each time the instrument is turned on.

Converting notes to RX Noises

RX Noises are special ambience or mechanical sounds that allow Sounds to be more realistic. They are usually located above C7, depending on the Sound.

- 1 Go to the **Settings > Menu > MIDI > General Controls** page.
- 2 Select the **Note to RX Noise** checkbox to convert incoming notes to RX Noises.

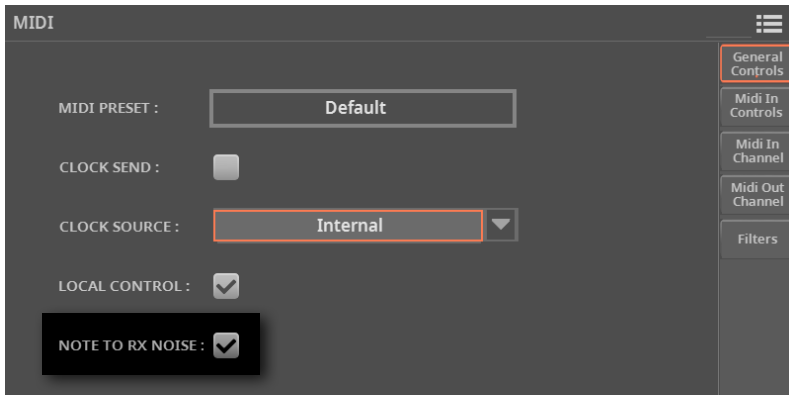

When this parameter is turned on, notes received from the **MIDI IN** or **USB** ports, or performed by the internal Players, in the RX Noises range, are recognized and converted to RX Noises.

This parameter is automatically activated each time the instrument is turned on.

Transposing the notes received

Applying master and octave transposition to the notes received

- 1 Go to the **Settings > Menu > Tuning > Transpose Control** page.
- 2 Use the **Master Transpose > MIDI IN Notes** checkbox to choose if notes received on the **MIDI IN** and **USB** ports have to be transposed.

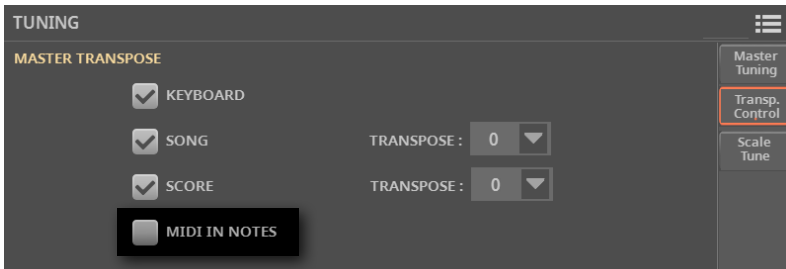

Midi In Transpose

Meaning

On

Notes received on the MIDI IN and USB ports are transposed according to the Master Transpose settings.

Off

Data received on the MIDI IN and USB ports are not transposed.

Applying octave transposition to the notes received

The **Upper/Lower Octave Transpose** parameter activates/deactivates the Octave Transpose values for the Upper and Lower Sounds.

- 1 Go to the **Settings > Menu > MIDI > MIDI IN Controls** page.
- 2 Use the **Upper/Lower Octave Transpose** checkbox to choose if notes received on the **MIDI IN** and **USB** ports have to be transposed when octave transposition is engaged.

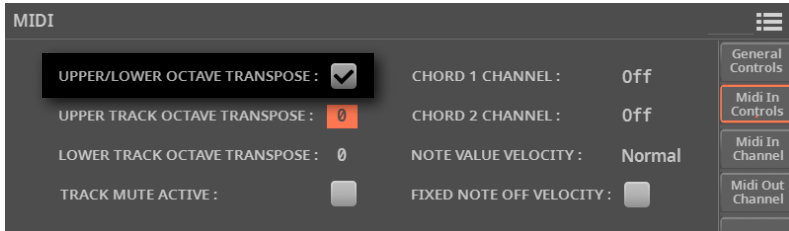

Midi In Octave	Meaning
On	Notes received on the MIDI IN and USB ports are transposed according to the Octave Transpose setting for each Sound.
Off	Data received on the MIDI IN and USB ports are not transposed.

Applying octave transposition to the Keyboard Sounds

- 1 Go to the **Settings > Menu > MIDI > MIDI IN Controls** page.
- 2 Use the **Upper Track Octave Transpose** and **Lower Track Octave Transpose** parameters to transpose the MIDI notes received on the Upper and Lower Sounds.

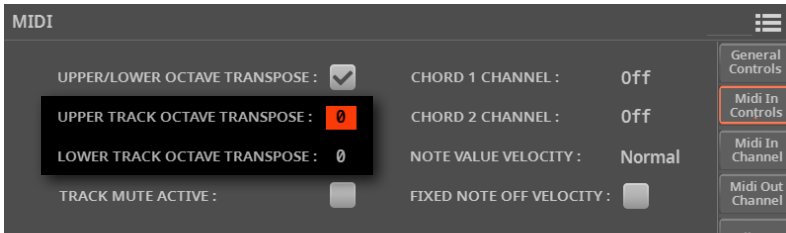

Upper/Lower Octave Meaning

-2...0...+2

Notes received on the MIDI IN and USB ports are transposed by the number of selected octaves. For example, if you select the +1 value, a C4 received via MIDI will play a C5 in Pa5X.

These parameters may be useful to many MIDI accordion players, whose MIDI interface may be transmitting on an unexpected octave.

Playing muted tracks via MIDI

You can mute the internal Sounds when playing the internal keyboard. You can, however, still use these Sounds from an external controller (like a KORG **microKEY**). This will let you play one of the internal Sounds from an external keyboard, with no need for an additional sound generator and a mixer.

- 1 Go to the **Settings > Menu > MIDI > MIDI IN Controls** page.
- 2 Use the **Track Mute Active** checkbox to choose if notes received on the **USB** port will play on muted tracks.

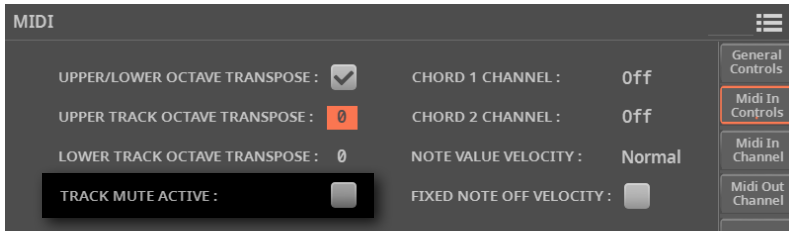

Track Mute Active

Meaning

On	No received MIDI data can play on muted tracks.
Off	Received MIDI data can play on muted tracks.

Choosing a fixed velocity value for the incoming notes

You can set a fixed velocity value for the notes received from MIDI.

- 1 Go to the **Settings > Menu > MIDI > MIDI IN Controls** page.

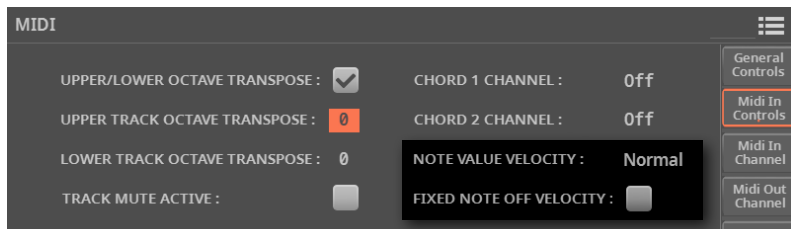

- 2 Use the **Note Velocity Value** parameter to set a fixed Note On velocity value for all the notes received via MIDI. This is useful when playing Pa5X with a MIDI accordion, often sending a fixed velocity value.

Depending on the status of the **Fixed Note Off Velocity** parameter, this may also affect the Note Off Velocity value.

Note Velocity Value	Effect on the received Note On Velocity values
Normal	Received velocity values are left unchanged.
40 ... 127	All received velocity values are converted to the selected value.

- 3 Use the **Fixed Note Off Velocity** parameter to set a fixed Note Off velocity value for all the notes received via MIDI. This is useful when playing with a controller sending too high a Note Off velocity value, that may cause issues with the sounds of Pa5X.

The effect of this parameter also depends on the status of the **Note Velocity Value** parameter.

Fixed Note Off Velocity	Note Velocity Value	Effect on received Note Off Velocity values
On	Any value	All Note Off Velocity values are set to 25.
Off	Normal	All values are left unchanged.
	40 ... 127	All values are set to the value specified by the Note Velocity Value parameter.

Programming the MIDI channels

Programming the MIDI IN channels

- 1 Go to the **Settings > Menu > MIDI > MIDI IN Channels** page.

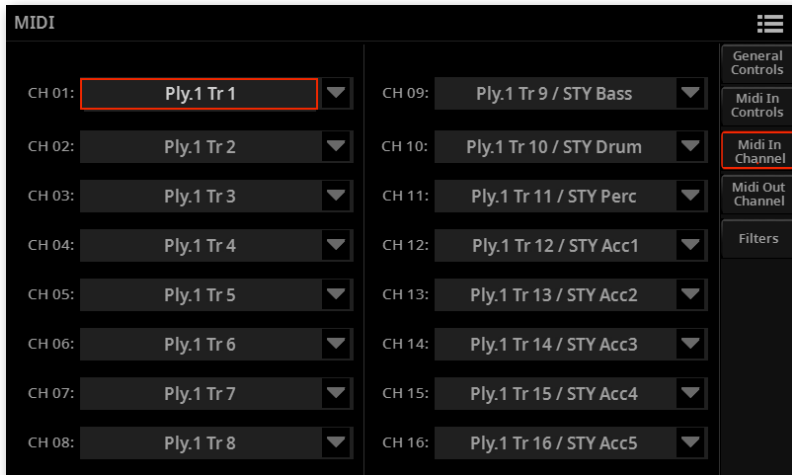

- 2 Use the **Channel** pop-up menus to assign an instrument's track to each MIDI channel. Please note that MIDI Song and Style tracks are combined.

Track	Meaning
Off	Nothing assigned
Lower	Keyboard's Lower Sound
Upper 1...3	One of the Keyboard's Upper Sounds
Sty Drum	Style's Drum Sound
Sty Percussion	Style's Percussion Sound
Sty Bass	Style's Bass Sound
Sty Acc 1...5	One of the Style's Accompaniment Sounds
Ply 1/2 Tr 01...16	One of the Players' tracks (Sounds).

Track	Meaning
Ply 1/2 Pad 1...4	One of the Pad Sounds
Global	Channel used to simulate Pa5X's integrated controllers (keyboard, pedals, joystick) with an external keyboard or controller. MIDI messages coming on this channel are seen as if they were generated by Pa5X's integrated controllers.
Control	On this channel, Pa5X receives MIDI messages to remotely select Keyboard Sets, Styles, Style Elements and SongBook Entries. See the tables in the Appendix, and later in this chapter, for more information about the data received.

Programming the MIDI OUT Channels

- 1 Go to the **Settings > Menu > MIDI > MIDI OUT Channels** page.

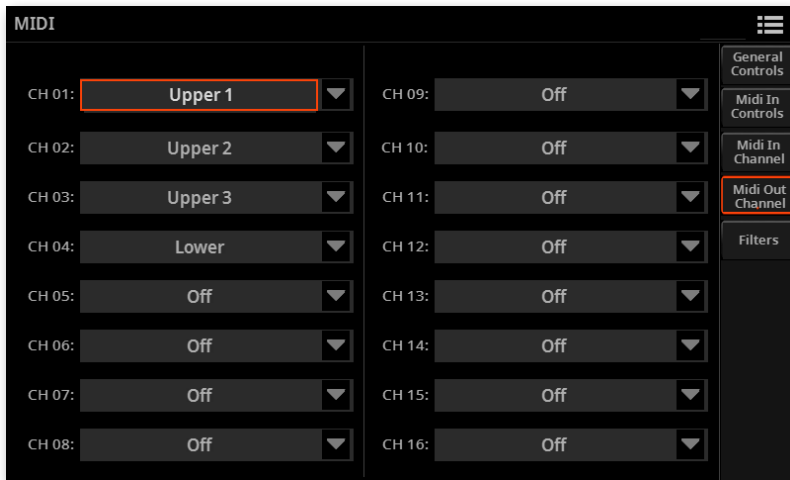

- 2 Use the **Channel** pop-up menus to assign an instrument's track to each MIDI channel. Please note that MIDI Song and Style tracks are combined.

Track	Meaning
Off	Nothing assigned
Lower	Keyboard's Lower Sound
Upper 1...3	One of the Keyboard's Upper Sounds
Sty Drum	Style's Drum Sound
Sty Percussion	Style's Percussion Sound
Sty Bass	Style's Bass Sound
Sty Acc 1...5	One of the Style's Accompaniment Sounds
Ply 1/2 Tr 01...16	One of the Players' tracks (Sounds).
Ply 1/2 Pad 1...4	One of the Pad Sounds
Chord	Use this channel to send notes recognized by the Chord Recognition engine to the MIDI OUT or USB port. This is useful, for example, to control an external Harmonizer playing on the Lower part (even if the part is muted).
Control	On this channel, Pa5X sends messages corresponding to the selected SongBook Entry.

Filtering out MIDI messages

You can set up to eight filters for the MIDI data received or sent. Filters are applied to all MIDI channels at the same time.

- 1 Go to the **Settings > Menu > MIDI > Filters** page.

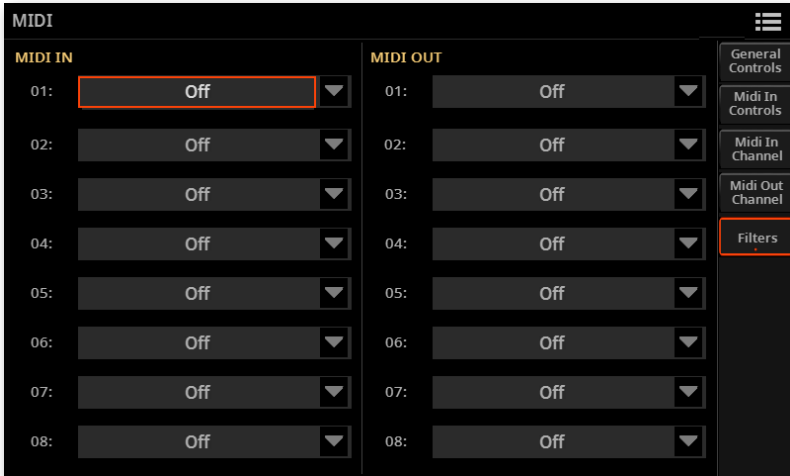

- 2 Use the **MIDI IN Filters** pop-up menus to choose filters on the data received.
- 3 Use the **MIDI OUT Filters** pop-up menus to choose filters on the data sent.

Filter	Meaning
Off	No filter
Pitch Bend	Pitch Bend
Mono Touch	Mono (or Channel) After Touch
Poly Touch	Poly After Touch
Prg. Change	Program Change
Sys. Exclusive	System Exclusive
All Ctrl. Ch.	All Control Change messages
0 ... 127	Control Change message #0...127. See the following pages for a list of the available Control Change messages.
Notes	Note events

Programming the Chord channels

- 1 Go to the **Settings > Menu > MIDI > MIDI IN Controls** page.
- 2 Use the **Chord 1 Channel** and **Chord 2 Channel** parameters to assign the Chord channels to a MIDI channel.

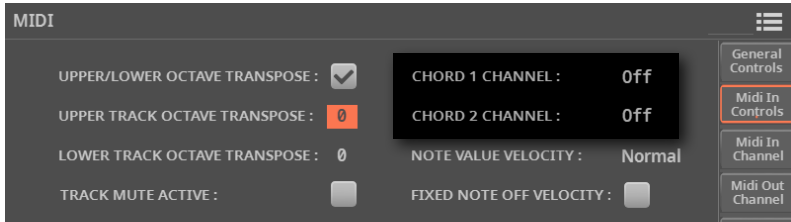

Chord channel

Meaning

Off

Chord channel not activated.

1...16

Assigned Chord channel. Two Chord channels can be used to receive notes for chord recognition. These notes will be combined with the notes that go through the channel set as Global (depending on the Chord Scan settings, Global notes may be recognized only under or above the split point, if the SPLIT indicator is lit up).

Control Change messages

The following is a table including all Control Change messages, and their effect on various functions of the instrument.

CC#	CC Name	Pa5X Function
0	Bank Select MSB	Sound selection
1	Modulation 1 (Y+)	Joystick forward
2	Modulation 2 (Y-)	Joystick backward
3	Undefined Controller	
4	Foot Controller	CC#04
5	Portamento Time	Portamento Time
6	Data entry MSB	Data entry MSB
7	Volume	Sound/Track Volume
8	Balance	
9	Undefined Controller	
10	Pan	Sound/Track Panning
11	Expression	Expression
12	FX Controller 1	CC#12
13	FX Controller 2	CC#13
14-15	Undefined Controller	
16	General Purpose 1	Ribbon controller
17	General Purpose 2	CC#17
18	General Purpose 3	CC#18
19	General Purpose 4	CC#19
20	Undefined controller	CC#20
21	Undefined controller	CC#21
22-31	Undefined controller	
Control Change #32-63 are the LSB (Least Significant Byte) of Control Change #0-31, i.e. the MSB (Most Significant Byte), and are changed according to their MSB counterparts.		
64	Damper	Damper pedal
65	Portamento On/Off	Portamento On/Off

CC#	CC Name	Pa5X Function
66	Sostenuto	Sostenuto pedal
67	Soft	Soft pedal
68	Legato	
69	Hold 2	
70	Sound Controller 1	
71	Sound Controller 2	Filter resonance
72	Sound Controller 3	Release time
73	Sound Controller 4	Attack time
74	Sound Controller 5	Brightness (Filter cutoff)
75	Sound Controller 6	Decay time
76	Sound Controller 7	Vibrato speed
77	Sound Controller 8	Vibrato depth
78	Sound Controller 9	Vibrato initial delay
79	Sound Controller 10	
80	General Purpose 5	Pa5X Sound Controller 1
81	General Purpose 6	Pa5X Sound Controller 2
82	General Purpose 7	Pa5X Sound Controller 3
83	General Purpose 8	CC#83
84	Portamento Control	
85-90	Undefined Controller	
91	FX 1 Depth	A/B Master FX 1 (reverb) send level
92	FX 2 Depth	
93	FX 3 Depth	A/B Master FX 2 (modulation) send level
94	FX 4 Depth	A/B Master FX 3 (free) send level
95	FX 5 Depth	
96	Data Increment	
97	Data Decrement	
98	NRPN LSB*	See table below(*)
99	NRPN MSB*	See table below(*)
100	RPN LSB	See MIDI Implementation Chart
101	RPN MSB	See MIDI Implementation Chart
102-119	Undefined Controller	
120	All Sound Off	All Sound Off
121	Reset All Controllers	Reset All Controllers

CC#	CC Name	Pa5X Function
122	Local Control On/Off	
123	All Notes Off	All Notes Off
124	Omni Off	
125	Omni On	
126	Mono On	
127	Poly On	

(*) The following NRPN messages are used to control the Sound and Drum Kit parameters.

NRPN	CC#99 (MSB)	CC#98 (LSB)	CC#06 (Data Entry)
Vibrato Rate	1	8	0...127
Vibrato Depth	1	9	0...127 ^(a)
Vibrato Decay	1	10	0...127 ^(a)
Filter Cutoff	1	32	0...127 ^(a)
Resonance	1	33	0...127 ^(a)
EG Attack Time	1	99	0...127 ^(a)
EG Decay Time	1	100	0...127 ^(a)
EG Release Time	1	102	0...127 ^(a)
Drum Filter Cutoff	20	dd	0...127 ^(a)
Drum Filter Resonance	21	dd ^(b)	0...127 ^(a)
Drum EG Attack Time	22	dd ^(b)	0...127 ^(a)
Drum EG Decay Time	23	dd ^(b)	0...127 ^(a)
Drum Coarse Tune	24	dd ^(b)	0...127 ^(a)
Drum Fine Tune	25	dd ^(b)	0...127 ^(a)
Drum Volume	26	dd ^(b)	0...127
Drum Panpot	28	dd ^(b)	0...127 ^(a)
Drum Rev Send (FX 1)	29	dd ^(b)	0...127 ^(a)
Drum Mod Send (FX 2)	30	dd ^(b)	0...127 ^(a)
Drum Send #3 (FX 3)	31	dd ^(b)	0...127 ^(a)

(a). 64 = No change to the original parameter's value

(b). dd = Drum Instrument No. 0...127 (C0...C8)

(*) The following NRPN messages are used to remotely select the SongBook Entries with their assigned ID number.

NRPN	CC#99 (MSB)	CC#98 (LSB)	CC#06 (Data Entry MSB)	CC#38 (Data Entry LSB)
SongBook Entry	2	64	0...99	0...99

The Song Book Entry number is selected by combining the Data Entry MSB (CC#06) and LSB (CC#38) messages. You may think to SongBook Entries as organized in banks of 100 entries each, selected using the Data Entry MSB message. Then, you can use the Data Entry LSB message to select a SongBook Entry within the selected bank.

Controlling the Styles and Songs via MIDI

You can remotely control the Players via MIDI. Please note that the Program Change and Control Change numbers shown in this page follow the 0-127 numbering system.

Selecting the Style Elements

You can remotely select the various Style Elements, by sending Program Change messages on the Control channel.

PC	Style Element	PC	Style Element	PC	Style Element	PC	Style Element
80	Intro 1	81	Intro 2	82	Intro 3/Count In	83	Variation 1
84	Variation 2	85	Variation 3	86	Variation 4	87	Fill 1
88	Fill 2	89	Fill 3	90	Fill 4	91	Break
92	Ending 1	93	Ending 2	94	Ending 3	-	

Selecting the Player controls

You can remotely send various commands to the Players, by sending them Program Change messages on the Control channel.

PC	Control	PC	Control	PC	Control
95	Fade In/Out	96	Style to Kbd Set	97	Auto Fill
98	Memory	99	Bass Inversion	100	Manual Bass
101	Tempo Lock	103	-	104	Play/Stop (Player 1)
105	Play/Stop (Player 2)	106	Synchro Start	107	Synchro Stop

Selecting the Keyboard Sets (from a Style or SongBook Entry)

You can remotely select the Keyboard Sets of a Style or SongBook Entry (four buttons under the X-FADER).

After having selected a Style or a SongBook Entry, send a Program Change messages corresponding to the Keyboard Set (on the Control channel).

SongBook Entry	PC	SongBook Entry	PC
KbdSet #1	64	KbdSet #2	65
KbdSet #3	66	KbdSet #4	67

Controlling the Mic and Guitar Processors via MIDI

You can control the Mic and Guitar Processors via MIDI, for example by connecting a MIDI pedalboard to the **MIDI IN** port of Pa5X.

You can choose a **MIDI Preset** to automatically configure the MIDI parameters according to the connected controlling device, but you may also want to customize them.

Programming MIDI IN for the Mic Processor

You can choose the input channel, transposition and the note range.

- 1 Go to the **Settings > Menu > MIDI > MIDI IN Controls** page.

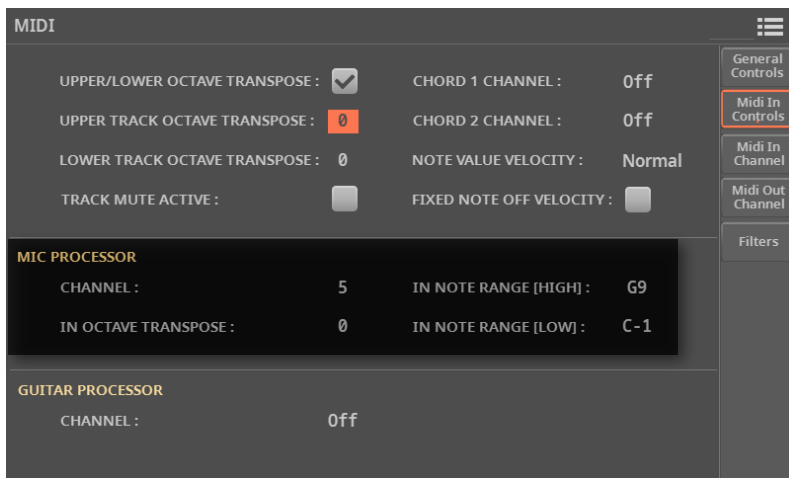

- 2 Use the **Mic Processor > Channel** parameter to choose a MIDI channel on which to receive chords or notes for the harmonizer.

- 3 Use the **Mic Processor > In Octave Transpose** parameter to transpose the chords or the notes received.

- 4 Use the **Mic Processor > In Note Range High/Low** parameters to set a range or notes to be sent to the Harmony section of the Mic Processor.

Programming MIDI IN for the Guitar Processor

You can choose the input channel.

- 1 Go to the **Settings > Menu > MIDI > MIDI IN Controls** page.

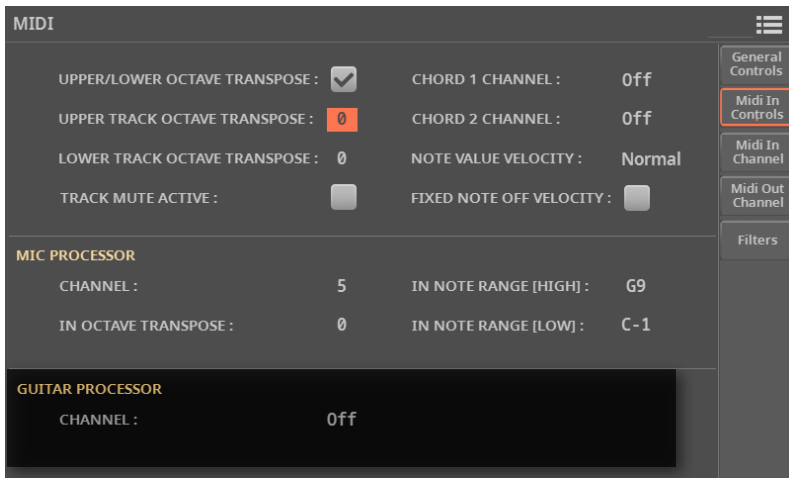

- 2 Use the **Guitar Processor > Channel** parameter to choose a MIDI channel on which to receive control messages for the various effects.

Choosing a Mic or Guitar Preset via MIDI

Mic and Guitar Presets can be selected by sending a series of messages on the MIDI channel assigned to the Mic/Guitar Processor.

- > Control Change #00 (Bank Select MSB) message with value '0'.
- > Control Change #32 (Bank Select LSB) message to choose the type of preset.

Type of Preset	CC32 Value
Factory	0
User	1
Local	2

- > Program Change message to choose the preset.

Preset	PC Number
Preset 1...112	0...111

Controlling the Guitar Processors volume

You can control the level of the Guitar Processors by using the Control Change #07 (Volume) message on the assigned MIDI channel.

Turning the Guitar effects on/off

Each of the effects in a Guitar Preset can be turned on or off, by sending a Control Change message on the Guitar Processor MIDI channel. (This does not work with the Mic Presets).

FX On/Off	CC Number
FX1	80
FX2	81
FX3	82
FX4	83

Receiving chords or notes for the voice harmonizer

If you are using an external device (sequencer, master keyboard, MIDI accordion...) to send chords or notes to the Mic Harmony section, you may want to set some MIDI parameters.

■ Choose an appropriate MIDI Preset

First of all, check if there is an appropriate MIDI Preset. You can learn more about the available presets in the chapter dedicated to MIDI (see [Quick setup using the MIDI Presets](#) on page 513).

- 1 Go to the **Settings > Menu > MIDI > General Controls** page.

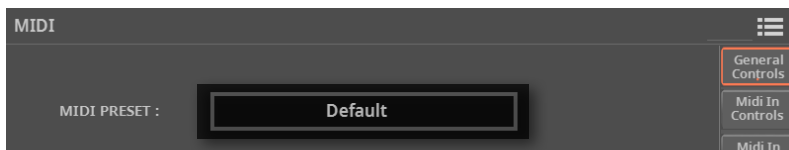

- 2 Choose a **MIDI Preset** matching your MIDI configuration.

■ Program the MIDI parameters

If you want to make your own custom settings, change some parameters.

- 1 Go to the **Settings > Menu > MIDI > MIDI IN Controls** page.
- 2 Use the **Mic Processor > Channel** parameter to choose a MIDI channel on which to receive chords or notes.
- 3 Use the **Mic Processor > In Octave Transpose** parameter to transpose the chords or the notes received.
- 4 Use the **Mic Processor > In Note Range High/Low** parameters to set a range or notes to be sent to the Harmony section of the Mic Processor.

Controlling other musical resources via MIDI

The SongBook can be deeply integrated with a tablet or personal computer. For detailed instructions see [Using the SongBook with a tablet or personal computer](#) on page 299.

22

Audio Outputs

Routing the internal Sounds to the outputs

Connecting the audio outputs

Connect the audio outputs as described in [Connecting the audio outputs](#) on page 18. If installed, the (optional) **PaAS** amplification system will work in parallel with the main audio outputs.

Choosing the audio outputs for the Sounds

Sounds from the Keyboard, the Styles or the MIDI Songs can be sent to separate audio outputs. This routing is global, and will not change when choosing a different Keyboard Set, Style or Song.

- 1 Go to the **Settings > Menu > Audio/Video > Keyboard** page, and select the audio output for each of the Keyboard Sounds.

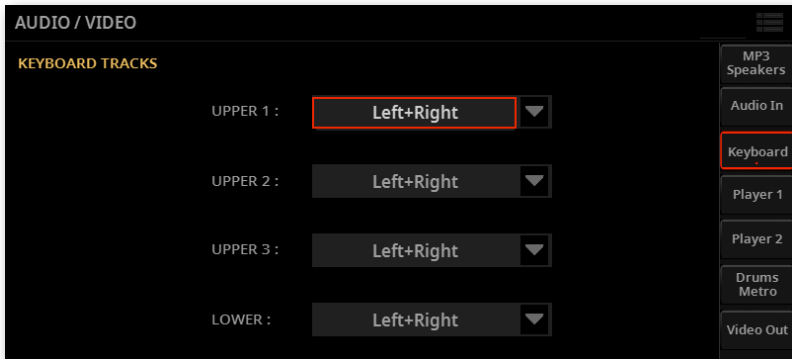

- 2 Go to the **Settings > Menu > Audio/Video > Player 1** page, and select the audio output for each of the Style, MIDI Song and Pad Sounds assigned to Player 1.

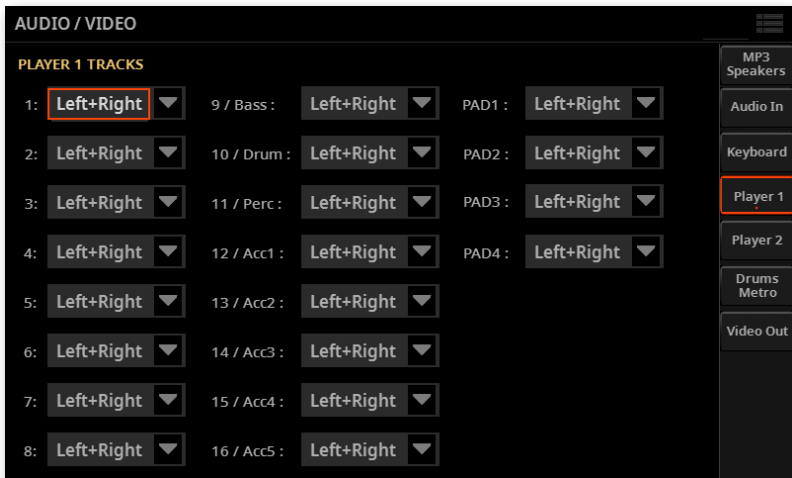

3 Go to the **Settings > Menu > Audio/Video > Player 2** page, and select the audio output for each of the Style, MIDI Song and Pad Sounds assigned to Player 2.

Audio Output	Meaning
Left+Right	The Sound is sent to the Left & Right outs, in stereo. It is also sent to the PaAS Amplification System, if installed. The Sound is also sent to the internal FX processors. You can use the MASTER VOLUME slider to adjust the volume.
Out 1+2, Out 3+4	The Sound is sent to the 1 & 2 or 3 & 4 sub-outs, in stereo. It is sent to the internal Insert FXs, but not to the Master FXs and the MaxxAudio FXs. The MASTER VOLUME slider has no effect on it.
Out 1 ... Out 4	The Sound is sent to one of the 1-4 sub-outs. It is mixed to mono. It is sent to the internal Insert FXs, but not to the Master FXs and the MaxxAudio FXs. The MASTER VOLUME slider has no effect on it.

Choosing the audio outputs for the Drum Kits

Sounds from each Drum family, can be sent to a separate audio output. This routing is global, and will not change when choosing a different Keyboard Set, Style or Song.

Drum Kits can be treated as a whole as ordinary Sounds, or as sets of separate percussive families that can be routed to different audio outputs.

Drum Kits treated as ordinary Sounds

You can send the Drum Kit to an audio output (or output pair) as an ordinary Sound. All the Drum families will be sent to the output chosen for the track the Drum Kit is assigned to.

- > Go to the **Settings > Menu > Audio/Video > Drum/Metro** page, and choose the **Drum Kit Output > As Track** option.

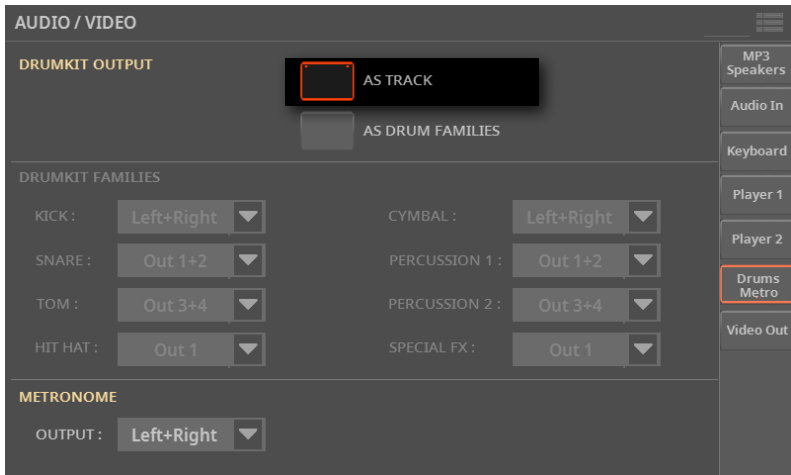

Drum Kits treated as separate Drum Families

Each Drum family can be sent to a separate audio output (or output pair). This is useful if you want, for example, to separately send the bass drum to an external compressor and sub-bass amplifier.

1 Go to the **Settings > Menu > Audio/Video > Drum/Metro** page, and choose the **Drum Kit Output > As Drum Families** option.

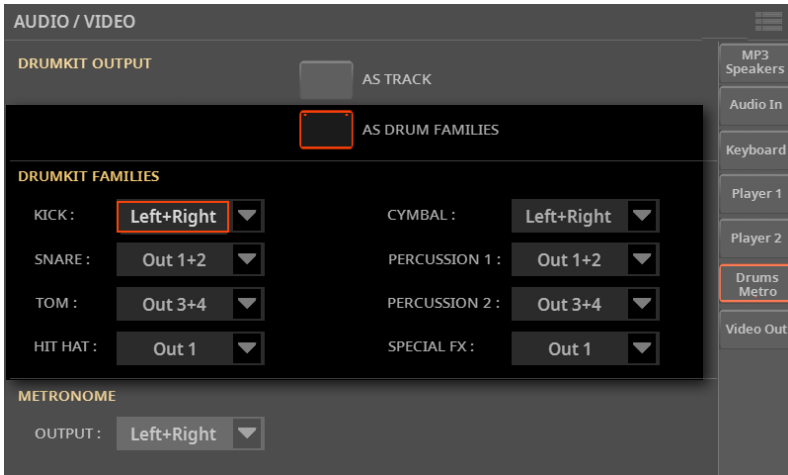

2 Use the parameters in the **Drum Kit Families** section to choose a separate output (or output pair) for each percussive family of instruments. The options are the same seen above for the ordinary Sounds.

Routing the MP3 Songs to the outputs

Choosing the audio outputs for the MP3 Songs

You can send the MP3 Songs to a separate audio output (or output pair), for separate mixing.

- 1 Go to the **Settings > Menu > MP3/Speakers** page.

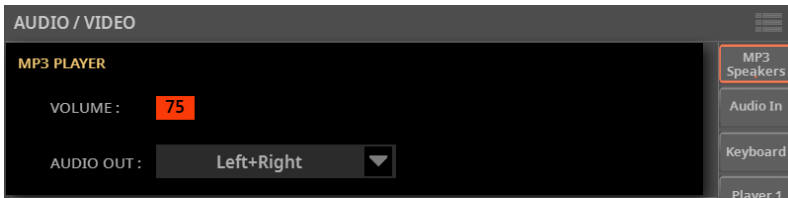

- 2 Use the **MP3 Player > Audio Out** pop-up menu to choose an audio output (or output pair) for the MP3 Songs.

Audio Output	Meaning
Left+Right	The MP3 Songs are sent to the Left & Right outs, in stereo. They are also sent to the PaAS Amplification System, if installed. You can use the MASTER VOLUME slider to adjust the volume.
Out 1+2, Out 3+4	The MP3 Songs are sent to the 1 & 2 or 3 & 4 sub-outs, in stereo. The MASTER VOLUME slider has no effect on them.

Setting the general volume of the MP3 Songs

You can balance the volume of MP3 Songs against that of the MIDI Songs and the Styles.

- 1 Go to the **Settings > Menu > Audio/Video > MP3/Speakers** page.

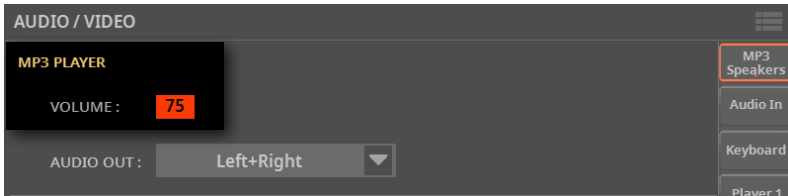

- 2 Use the **MP3 Player > Volume** parameter to set the maximum volume of the MP3 Player.

MP3 Volume	Meaning
0 ... 100	Max volume in percentage.

Controlling the volume of the MP3 Songs

You can adjust the volume of the MP3 Songs during playback.

- 1 Be sure the selected **CONTROL** mode is **MAIN**.
- 2 Depending on the Player the MP3 Song is assigned to, use either **SLIDER #7** (Player 1) or **SLIDER #8** (Player 2) to adjust the Song volume.

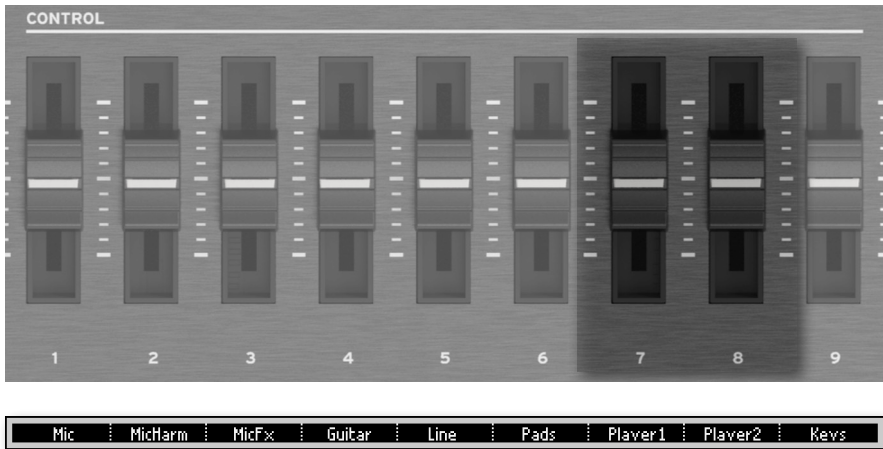

As an alternative, use the **Player 1/2 Volume** controls you can find in the **Home > Control** page (with the **Main** view mode selected).

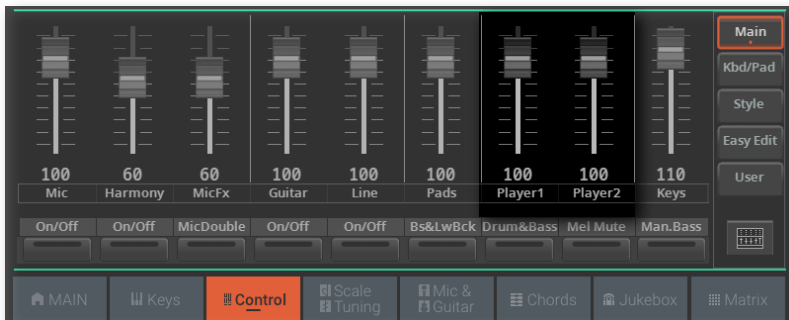

Routing the metronome to the outputs

You can send the metronome click to any of the separate audio outputs (or output pairs). This will allow, for example, to send the click to the drummer's headphone amplifier only.

- 1 Go to the **Settings > Menu > Drum/Metro** page.

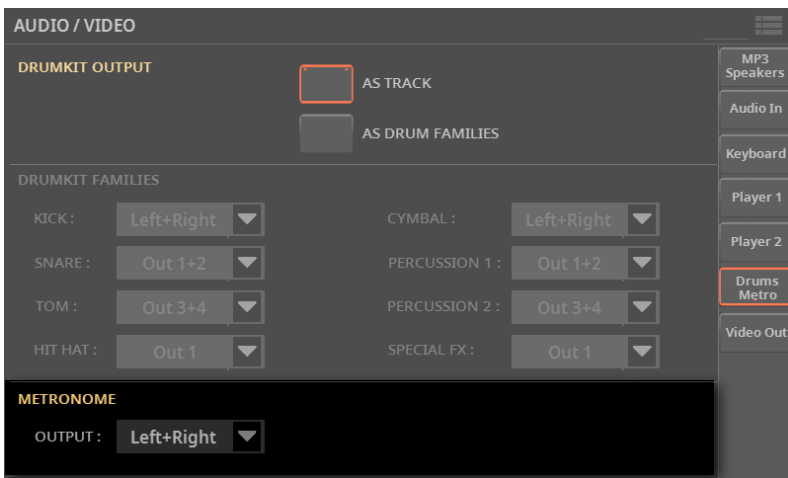

- 2 Use the **Metronome > Output** pop-up menu to choose an audio output (or output pair) for the metronome click.

Audio Output	Meaning
Left+Right	The Metronome click is sent to the Left & Right outs, in stereo. It is also sent to the PaAS Amplification System, if installed. The click is also sent to the internal FX processors. You can use the MASTER VOLUME slider to adjust the volume.
Out 1+2, Out 3+4	The Metronome click is sent to the 1 & 2 or 3 & 4 sub-outs, in stereo. It is not sent to the internal FX processors. The MASTER VOLUME slider has no effect on it.
Out 1 ... Out 4	The Metronome click is sent to one of the 1-4 sub-outs, in mono. It is not sent to the internal FX processors. The MASTER VOLUME slider has no effect on it.

Setting the mastering effects on the audio outputs

Turning the MaxxAudio on/off

You can turn the MaxxAudio® effects on or off, to experiment with the results of the processing.

- 1 Go to any page of the **Settings > Menu > Waves** section.
- 2 Use the **On/Off** button on top of the page to turn the MaxxAudio® effects on or off.



Please note that MP3 Songs are always recorded without the MaxxAudio® effects. This will avoid adding final processing to the processing already applied to the MP3 files.

Choosing a Maxx Preset

The result of KORГ's long-term cooperation with Waves Audio, the MaxxAudio® suite helps making the sound louder, clearer, fuller, and more polished. These effects apply to the final stage of the audio path, just before the audio outputs.

You can quickly program the EQ and Master parameters by choosing a Maxx Preset.

- 1 Go to any page of the **Settings > Menu > Waves** section.
- 2 Touch the **Maxx Preset** name on top of the page.



As soon as you press the button or touch the display, the **Maxx Preset Select** window appears.

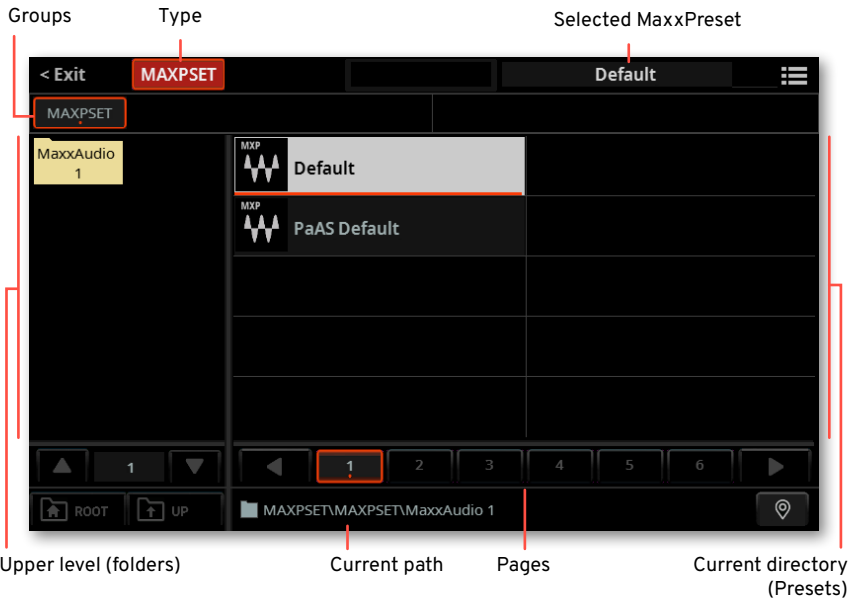

Choosing a default Maxx Preset

Pa5X can automatically select a Maxx Preset depending on the type of audio output. You can choose the default presets that will be automatically selected.

- 1 Go to the **Settings > Menu > Waves > Default Preset** page.

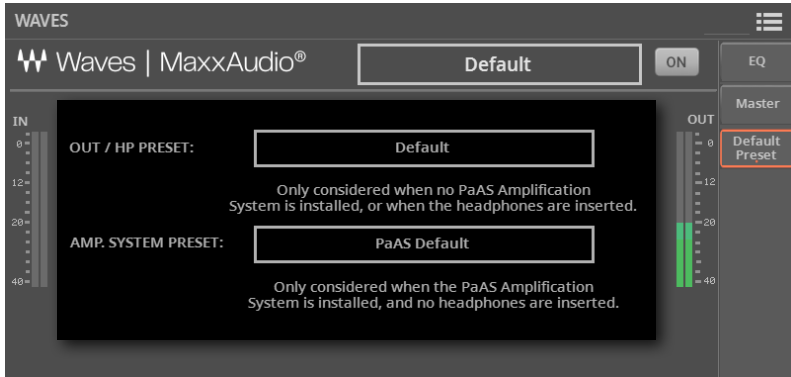

- 2 Touch the **Maxx Preset** names to open the **Select** window and choose a Maxx Preset.

Maxx Preset	Meaning
Out / HP Preset	Audio Outputs or Headphones. Only considered when no PaAS Amplification System is installed, or when the headphones are inserted.
Amp. System Preset	Amplification System. Only considered when the PaAS Amplification System is installed and no headphones are inserted.

Editing the MaxxAudio® EQ

The MaxxAudio® EQ is a full-spectrum frequency equalization, positioned at the end of the signal chain, just before the main audio outputs. It gives you the power to design EQ curves and shape your sound. Based on Waves professional audio equalizers, this EQ features seven fully programmable bands with fully adjustable gain, frequency, and Q parameters.

Accessing the MaxxAudio® EQ

- > Go to the **Settings > Menu > Waves > EQ** page.

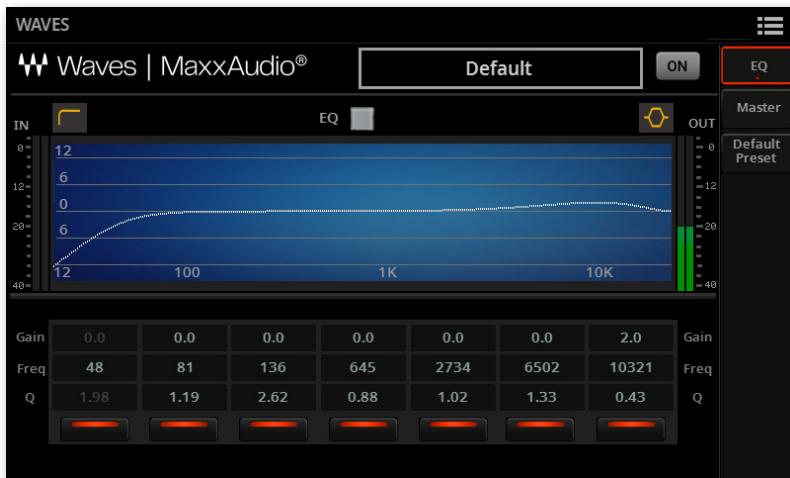

Turning the MaxxAudio® EQ on/off

- > Use the **EQ** checkbox to turn the EQ on/off.

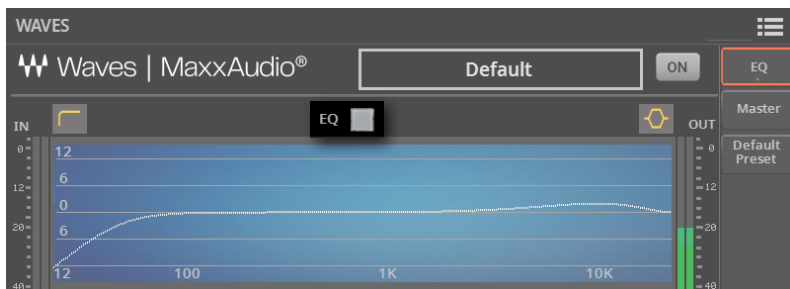

Programming the EQ

- > Look at the results of any edit in the **diagram**. The diagram shows the EQ curve. Its shape changes depending on the various parameter values.

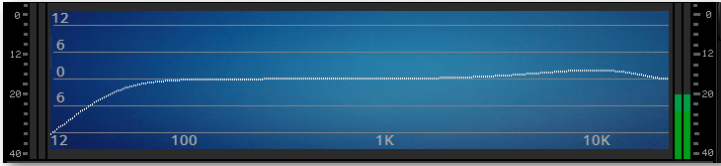

- > Touch the **curve shape** on the top-left or top-right corner of the EQ diagram, and choose between the different types of curve for the lowest and highest bands.

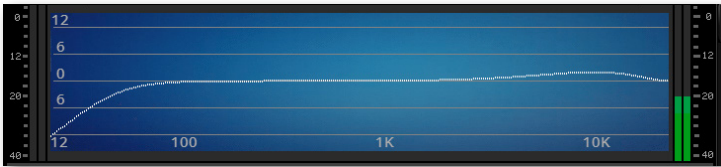

EQ Shape

Meaning



Bell-shape curve, allowing for detailed correction of a specific range of frequencies. The selected frequency is at the center of the EQ band.



Low-shelving curve, allowing for smoothly cutting or boosting the lowest frequencies. This will let you add more body to the sound (boost), or remove boomy frequencies (cut).



High-shelving curve, allowing for smoothly cutting or boosting the highest frequencies. This can help adding 'air' to the mix (boost), or remove sibilance (cut).



Low-cut (or high-pass) curve, letting you cut the lowest frequencies. Drastically removing the very low frequencies helps getting rid of bass frequencies out of the useful musical range, but stealing energy to the mix.



High-cut (or low-pass) curve, letting you cut the highest frequencies. Drastically removing the very high frequencies helps removing unwanted noise out of the useful musical range.

- > Use the **IN/OUT** indicators to check the level of the audio entering and coming out of the MaxxAudio® processor. Be sure the indicators never go to the red area (since this means distortion).
- > Use the **Gain** parameter to change the emphasis or attenuation of the corresponding band. Use it to make the frequencies stronger or weaker.
- > Use the **Freq** parameter to change the center frequency of the corresponding band. Center it on the problematic frequency, or the harmonics you want to emphasize or attenuate.

- > Use the **Q** parameter to adjust the ‘quality factor’ of the EQ filter; higher values correspond to narrower, more accurate filters. Use higher values for near-surgical correction on isolated frequencies, lower values for more musical, softer equalization.
- > Use the **On/Off** buttons under each band to turn the corresponding bands on or off.

Editing the MaxxAudio® Master

The MaxxAudio® Master controls the MaxxBass, MaxxTreble, MaxxStereo and MaxxVolume effects. It is positioned at the end of the signal chain, just before the audio outputs, adds to the sound deeper, richer bass, and cleaner, warmer, more articulate treble with no loss of RMS (that is, average perceived volume). Processing also results in a stereo image that's wider and more accurate.

Please keep in mind that summing-up all levels could cause distortion in the PaAS Amplification System or in external amplification systems. Be careful not to max-out all sliders.

Accessing the MaxxAudio® Master

- > Go to the **Settings > Menu > Waves > Master** page.

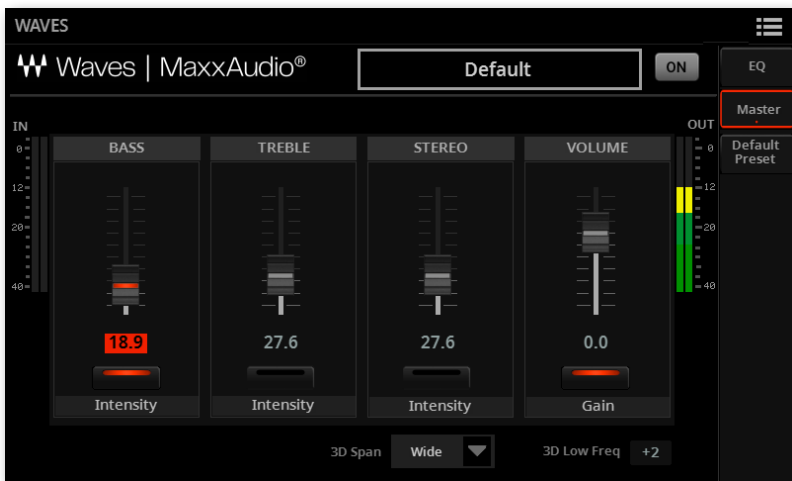

Turning the separate effects on/off

- > Use the **On/Off** buttons under each slider to turn the corresponding effect on/off.

Programming the Master effects

- > Use the **IN/OUT** indicators to check the level of the audio entering and coming out of the MaxxAudio® processor. Be sure the indicators never go to the red area (since this means distortion).
- > Use the **virtual sliders** to increase or decrease the level of the corresponding parameter.

If the input level is too high, decrease the level of the Sounds, Styles, Songs that are playing. Check the level of the **Finalizer** effect in the **Home > Menu > Mixer/FX** section.

If the output level is too high, decrease the level of the various MaxxAudio® controls (in particular, the Volume control).

MaxxBass

MaxxBass is for low frequency response beyond what your loudspeakers can deliver. You will hear low frequencies as much as 1.5 octaves below the limits of your loudspeakers.

MaxxBass isolates the low bass frequencies that can't be reproduced by the loudspeakers. The low frequencies are analyzed to create a complex set of higher frequency harmonics, which the loudspeakers can reproduce.

These harmonics are added back to the rest of the audio, replacing the original low frequencies. Your loudspeakers then reproduce the harmonic series, which are perceived by the brain as the original low frequencies. Finally, MaxxBass uses dynamic compression to focus and clarify the lower frequencies.

The result is a larger, more powerful sound, with extended bass response up to 1.5 octaves below the roll-off frequency of the loudspeaker.

MaxxTreble

MaxxTreble is for enhanced high frequencies; it is ideal for one-way driver systems.

Using technologies originally developed for Waves own audio plug-ins, MaxxTreble is a non-linear dynamic processor that enhances high frequency response, delivering a clean and pleasant high end, while minimizing distortion.

Using MaxxTreble technology you will be able to deliver louder, crisper and better defined high end without having to worry about clipping or peak-limiting.

MaxxStereo

MaxxStereo is for more realistic, wider stereo imaging. You will hear a wide, exciting stereo image, similar to what you'd hear in a modern movie theater.

MaxxStereo spatial imaging technology improves the stereo separation of closely placed loudspeakers. With loudspeakers that are very close to the other (like in the optional PaAS Amplification System), MaxxStereo increases perceived separation for optimal imaging, with natural sound and a generous listening position.

MaxxVolume

MaxxVolume is for dynamics compensation. It increases (or decreases) RMS levels, delivering louder sound with no audible distortion.

It relies on Peak Limiting, that increases volume without clipping or audible distortion; Low Level Compression, that increases the clarity of soft sounds, especially in noisy environments and at quiet volumes; and Noise Gating, that eliminates background signal and system noise.

Saving a Maxx Preset

You can save a Maxx Preset, to create a library of settings for the different performing situations (for example, for playing at rehearsals or on stage).

■ Open the Save dialog

- 1 Go to the any page of the **Settings > Waves** section.
- 2 Choose the **Save Maxx Preset** command from the **page menu** (☰). The **Save Maxx Preset** dialog will appear.

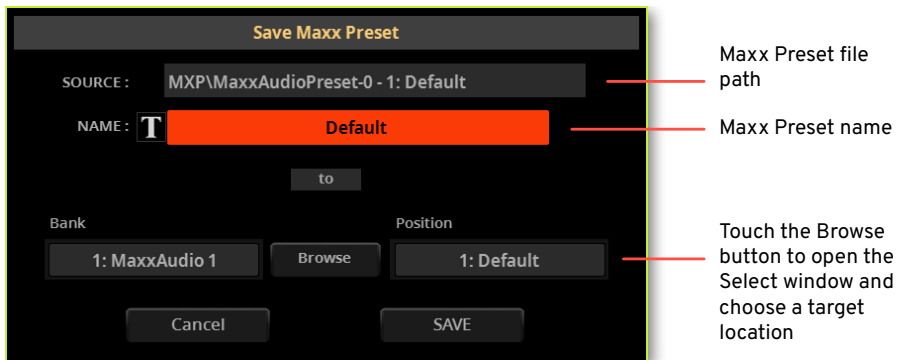

■ Rename the Maxx Preset

While in the **Save Maxx Preset** dialog, you may change the **name** of the Maxx Preset.

- 1 Touch the **Text Edit** (T) button to open the **virtual keyboard** and edit the name.
- 2 When done editing the name, confirm by touching the **OK** button under the virtual keyboard.

■ Save over the same Maxx Preset

- > If you want to overwrite the current Preset, just touch the **Save** button.

■ Save to a different Maxx Preset location

- 1 If you want to save to a different location, touch the **Browse** button and open the **Maxx Preset Select** window.

- 2 Touch the folder where you want to save the new Maxx Preset. Don't touch any of the existing Maxx Preset names, unless you want to overwrite them!

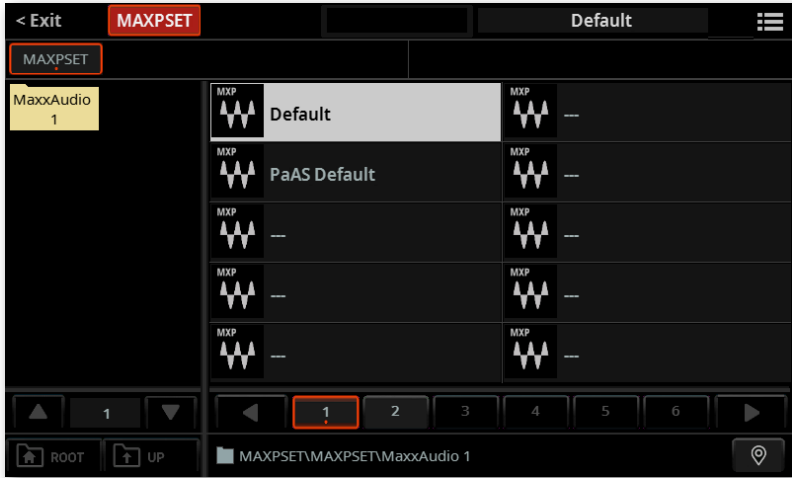

- 3 Find an empty location, shown as three hyphens ('---'), and touch it.

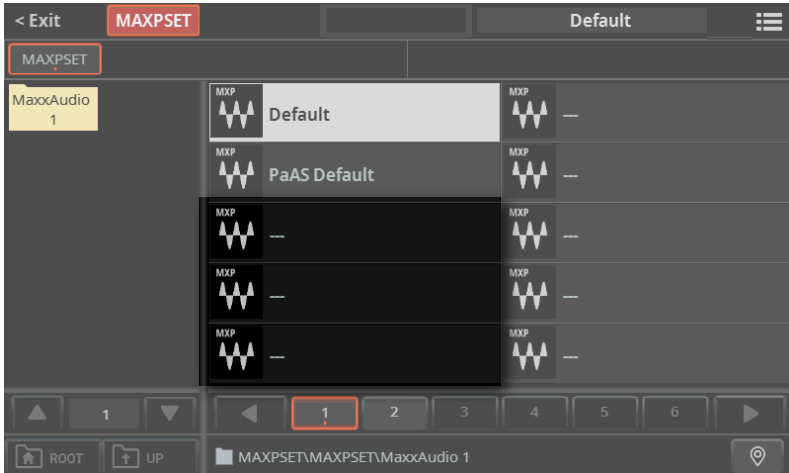

- 4 Press the **EXIT** button to close the **Select** window and confirm your selection.
- 5 When back at the **Save Maxx Preset** dialog, confirm the Save operation by touching the **Save** button.

23

Microphone Input

Connecting a microphone

WARNING: Lower the master volume!

Before connecting or disconnecting something to one of the audio inputs, lower the **Master Volume** to zero. Preventing from doing it may damage the speakers and cause harm to your hearing!

Connecting and activating the microphone

Microphone types

There are two main types of microphones that you can connect to your Pa5X: dynamic and condenser.

Dynamic microphones don't require powering. They are usually conceived for live use, and have a narrow cardioid or hypercardioid pattern for better rejection of stage noise.

Condenser microphones require phantom powering supplied by Pa5X. More commonly found in the studio, these microphones usually come with a wider cardioid pattern, capturing more ambience and deeper basses. Large-diaphragm condenser microphones are the preferred ones for studio voice applications.

Connecting the microphone

Use the **MIC INPUT** connector to connect a microphone. This is a combo connector, featuring an XLR and a balanced (TRS) 1/4" (6.35 mm) jack on the same socket. We suggest to use the XLR jack to connect any microphone.

The 1/4" jack may be used to connect a dynamic microphone, if you don't have a cable with an XLR connector. Please note there is no phantom power on it, so you can't use it to connect a condenser microphone.

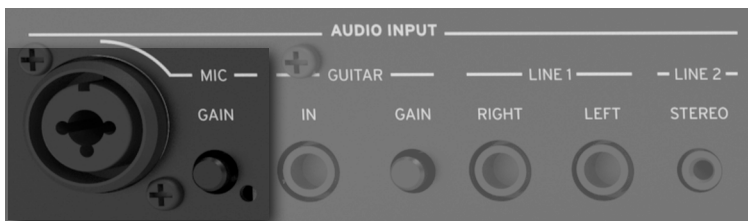

Turning on/off the microphone channel

- 1 Be sure the selected **CONTROL** mode is **MAIN**.
- 2 Use **BUTTON #1 (Mic On/Off)** to turn the microphone channel on or off.

Please note that, for safety reasons, the input is always switched off when turning the instrument on.



As an alternative, use the **Mic On/Off** command you can find in the **Home > Control** pane (with the **Main** control mode selected).



Routing the microphone to one of the audio outputs

By default, the microphone is sent to the main Left and Right audio outputs. You can change the output routing and send it to any other output pair.

- > Go to the **Settings > Menu > Audio/Video > Audio In** page.
- > Set the **Microphone In > Audio Out** parameter to the desired audio output.

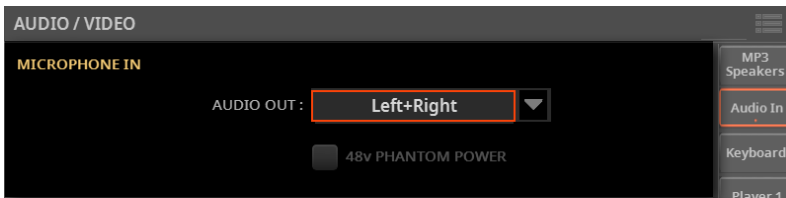

Audio Out	Meaning
Left+Right	Main LEFT and RIGHT outputs
Out 1+2	Separate sub-outputs 1-2
Out 3+4	Separate sub-outputs 3-4

Powering a condenser microphone

Condenser microphones require powering, supplied as a +48V phantom power current on the **XLR MIC** input.

■ Turn on the phantom power

1 Go to the **Settings > Menu > Audio/Video > Audio In** page, and select the **+48V Phantom Power** checkbox.

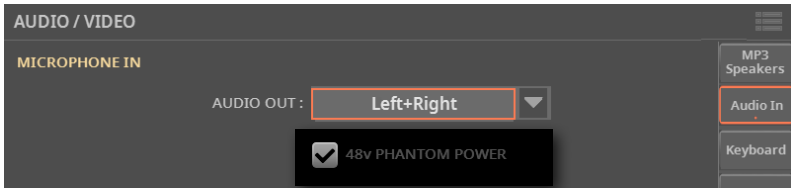

2 If it is off, turn on the **Mic** channel.

3 Sing into the microphone to check if the microphone is powered and working.

■ Turn off the phantom power

When disconnecting a microphone from the XLR jack, the phantom power is automatically turned off. Phantom power is also automatically turned off each time you turn the Pa5X off.

As an alternative, you can go to the **Settings > Menu > Audio/Video > Audio In** page, and deselect the **+48V Phantom Power** checkbox.

Adjusting the level of the microphone

Adjusting the microphone input gain

After having connected a microphone, adjust the input gain, to be sure it will not distort.

■ Preparation before starting adjusting the gain

- 1 Be sure the selected **CONTROL** mode is **MAIN**.
- 2 Use **BUTTON #1 (Mic On/Off)** to turn on the microphone channel.
- 3 Use **BUTTONS #2 (Mic Harmony On/Off)** and **#3 (Mic Double On/Off)** to turn off the Harmony and Double effects. If on, they would interfere with the adjustments.



As an alternative, use the **Harmony On/Off** and **Mic Double On/Off** commands you can find in the **Home > Control** pane (with the **Main** view mode selected).



■ Adjust the gain

1 Use the **GAIN** knob next to the **MIC INPUT** connector to adjust the input gain (from +20 to +55 dB).

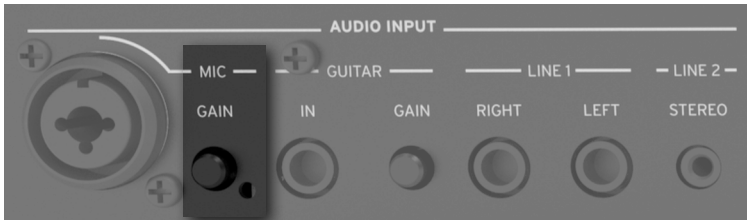

2 Sing into the microphone.

3 Check the input level in the **Settings > Menu > Mic Setup > EQ/Dynamics** page.

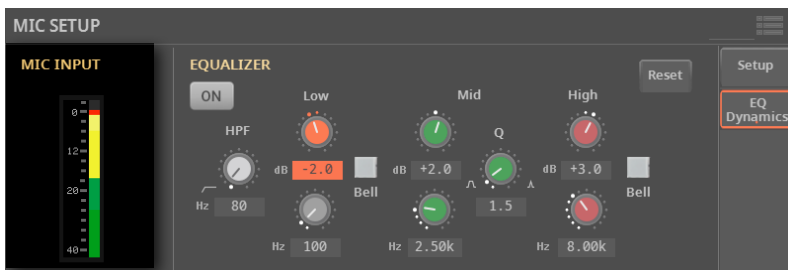

AUDIO IN color	Meaning
Off	No signal entering.
Green	Low- to mid-level signal entering. If the indicator turns off too often, the input gain is too low. Use the GAIN control to increase the input level.
Yellow	Slight overload in the signal path. This is fine if it turns on only on signal peaks.
Red	Clipping is occurring in the signal path. Use the GAIN control to lower the input level.

Keep the level so that this indicator remains green most of the time, with yellow appearing at signal peaks. Never go to red.

Adjusting the microphone volume

The microphone can be quickly turned on or off, and its volume in the mix adjusted, right from the control panel or from the main page.

- 1 Be sure the **Mic** channel is turned on.
- 2 Be sure the selected **CONTROL** mode is **MAIN**.
- 3 Use **SLIDER #1 (Mic)** to adjust the microphone channel volume.

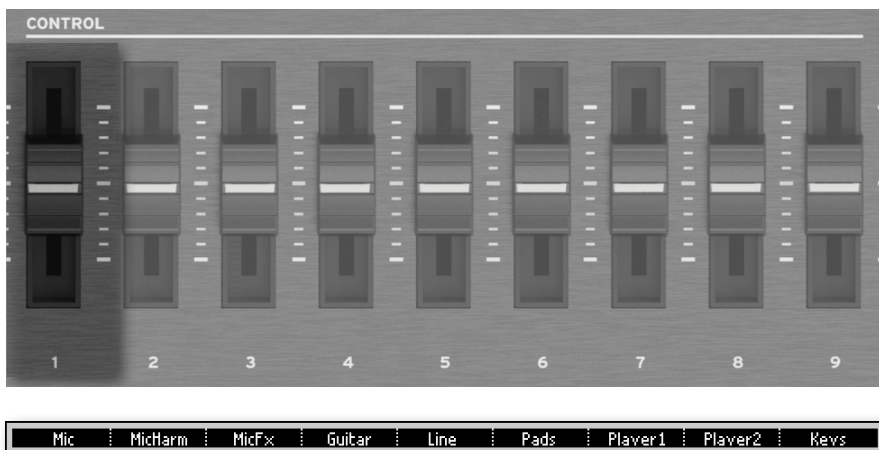

As an alternative, use the **Mic Volume** control you can find in the **Home > Control** pane (with the **Main** view mode selected).



- 4 Start a Style or a Song to balance your voice against the Sounds.
- 5 Check that the audio is well balanced and is not distorting.

Shaping the microphone input

Choosing a global Mic Preset

You can choose a global Mic Preset that will be automatically selected when turning the instrument on.

- 1 Go to the **Settings > Menu > Mic Setup > Setup** page.

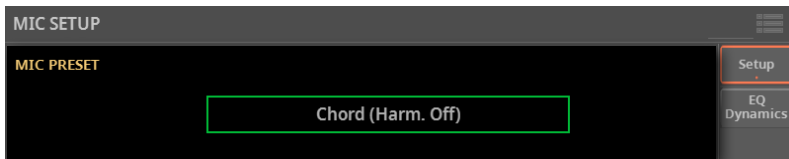

- 2 Touch the name of the selected **Mic Preset** to open the **Mic Preset Select** window.

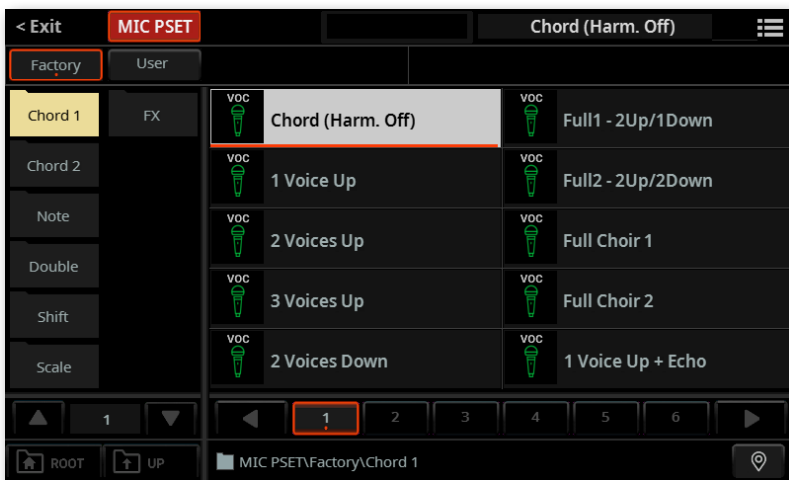

- 3 Choose one of the presets. For more details, see [Choosing a Mic Preset](#) on page 589.
- 4 Press the **EXIT** button to close the **Select** window and confirm your selection.

Basic settings for the lead voice

The lead voice is your voice, or the one of your singer, entering the microphone input. You can apply the effects, before sending it to the Mic Processor.

- > Go to the **Settings > Menu > Mic Setup > Setup** page to set the controls for the lead voice.

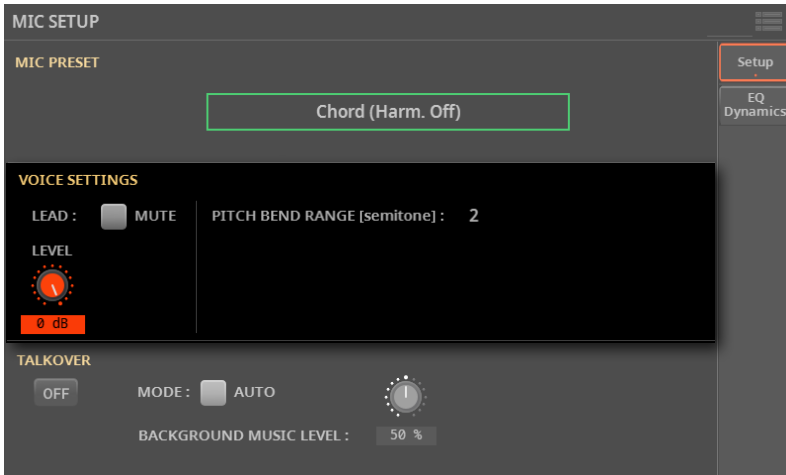

Muting the lead voice

When the lead voice is muted, you will only listen to the harmony voices and effects. You will sing in the choir generated by Pa5X.

- > While in the **Settings > Menu > Mic Setup > Setup** page, use the **Lead > Mute** checkbox to make the lead voice appear or disappear from the mix.

Adjusting the level of the lead voice

You can adjust the level of the lead voice in the mix.

- > Go to the **Settings > Menu > Mic Setup > Setup** page, and use the **Level** knob to adjust the level of the lead voice.

Parameter	Meaning	Value
Level	Level of the Lead Voice	Off, -60dB...0dB

Setting the Pitch Bend range

You can set the bending range (in semitones) applied to the harmony voices after receiving a Pitch Bend message.

- > While in the **Settings > Menu > Mic Setup > Setup** page, use the **Pitch Bend Range** parameter to set the range.

Adding EQ, compression and gate to the lead voice

You can program equalization, compression and gate for the lead voice.

- Go to the **Settings > Menu > Mic Setup > EQ/Dynamics** page.

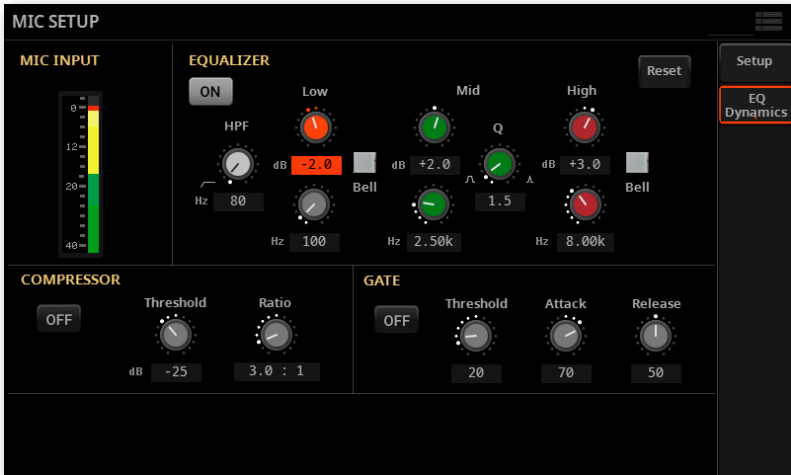

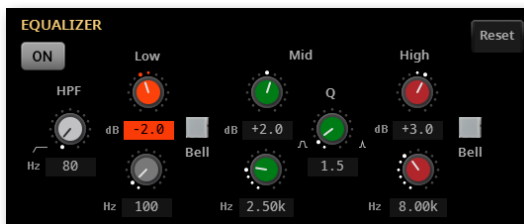

Programming the Equalizer

Use the **Equalizer** to make the sound brighter or darker, reduce sibilance or boominess, give more body to the voice. This is a 3-band Semi-Parametric EQ, including a High-Pass Filter.



The **High-Pass Filter (HPF)** cuts all the frequencies below the selected frequency (from 20 to 1000 Hz). This is useful to reduce plosive consonants or rumbling noise.

The two **Low** and **High** EQ bands boost or cut all frequencies below or above the frequencies set by the **Frequency (Hz)** controls. They can be set either as Bell- or Shelving-shaped curves by using the **Bell** buttons.

EQ Shape	Meaning
Bell On (Bell) 	Bell-shape curve, allowing for detailed correction of a specific range of frequencies. The selected frequency is at the center of the EQ band.
Bell Off (Low Shelving) 	Low-Shelving curve, allowing for smoothly cutting or boosting the lowest frequencies. This will let you add more body to the sound (boost), or remove boomy frequencies (cut).
Bell Off (High Shelving) 	High-shelving curve, allowing for smoothly cutting or boosting the highest frequencies. This can help adding 'air' (boost), or remove sibilance (cut).

The **Mid** Parametric EQ boosts or cuts the frequencies within a selected band, that is defined by a center frequency selected with the **Frequency (Hz)** knob, and a width selected with the **Q** knob (the 'Quality' control).

The three **Gain (dB)** controls allow +/-18 dB of adjustment. The three **Frequency (Hz)** controls range from 20 Hz to 20 kHz.

Programming the Compressor

Use the **Compressor** to reduce the range between louder and softer singing to produce more even-sounding vocals.

We typically sing dynamically, like this (capitals are used to show louder dynamics):

I LOVE to watch you WALK down the STREET

At acoustic singing levels with no, or very quiet instrumentation, this would sound fine. When amplified, however, the loud words become strident and even worse, quiet words can be lost in the instrument sounds. The louder the amplification system and band the more pronounced the loud parts become. Compression seeks to do the following to your dynamics:

I LOVE to watch you WALK down the STREET

Applied appropriately, the difference between loud and soft is reduced without killing the interesting dynamics in your performance.



The **Threshold** control sets the singing level at and above which the amount of gain reduction (compression) specified by the Ratio control will occur. The range is 0 dB to -40 dB: 0 dB being the loudest input signal the Voice Processor can accept without distortion and -40 dB being a very quiet signal. If you sing consistently more quietly than the Threshold, you will not hear any compression. A good setting for experimentation is -10 dB.

The **Ratio** control sets how much gain reduction you prefer when your voice level goes above the threshold. The range is from 1.0 : 1 (no gain reduction) to 50.0 : 1 and then Inf : 1 (maximum vocal gain reduction). A good setting where to start from for Ratio is 4.0 : 1.

The number on the left side of the : (colon) symbol is how loud the peaks in your singing have to be in order to achieve a 1 dB gain increase. A brief example of how adjusting the ratio of the compressor works is this: say a word you sang went 4 dB over the threshold when the Ratio was set to 4.0 : 1. The compressor would only allow it to go 1 dB louder.

Note that the **Ratio** control has to be set above 1.0 : 1 to apply any compression regardless of the setting of the **Threshold**.

Programing the Gate

Use the **Gate** if you hear feedback or there are other sounds entering the mic other than your voice.

A typical, fixed gate works by shutting off, or reducing the level of any signal below a threshold that you set. When you sing louder than that threshold, the gate will open and your vocal will come through the amplification system. When you aren't singing, the gate will close and block sounds around you.

You can also turn the gate to **Off** with good results if you are in a quiet, low volume musical environment.



Use the **Threshold** knob (ranging from 0 to 100) to define the minimum singing level you need to reach in order for the Gate to open and let your voice sound. The factory default setting is very sensitive to allow a wide range of singing levels but it may also allow more nearby instrumental sounds through when you are not singing. In this case, further adjustment from there and upward may be needed.

The factory setting is gentle enough that if your voice strays below the threshold, it is not cut off completely. If you are in a feedback-prone environment (loud monitors plus EQ and Compress on) you can increase this to reduce more. A setting of '0' offers no gain reduction on your lead voice at all.

The **Attack** control sets how fast the Gate enters, and the **Release** control how fast it exits after the signal has exceeded the threshold or has fallen below. Experiment with them to see how effective the Gate may be in a particular situation.

Talking with your audience

Soloing your voice (TalkOver)

During a show, you can lower the background music, so that you can be clearly heard by your audience.

Activating the TalkOver from the Home page

- 1 Go to the **Home > Mic & Guitar** pane.

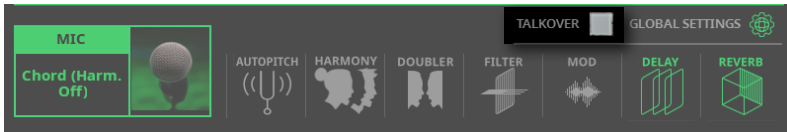

- 2 Select the **TalkOver** checkbox to lower the background music and talk to your audience.
- 3 When done, touch the **TalkOver** checkbox again to deselect it, and make the music return to the normal volume.

Activating the TalkOver from the Settings page

1 Go to the **Settings > Menu > Mic Setup > Setup** page to set the TalkOver parameters.

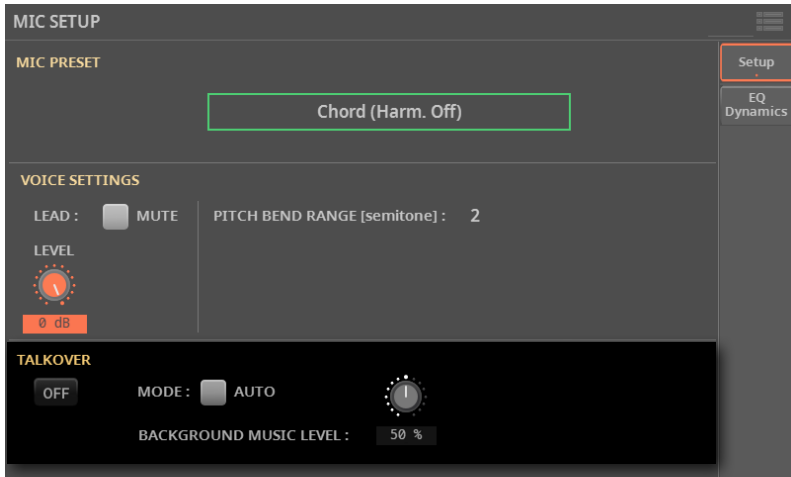

2 Use the **On/Off** button to turn the TalkOver function on/off.

Activating the TalkOver from a switch

You can assign the Mic TalkOver function to a **CONTROL** button, an **assignable switch** or a **footswitch**. See the relevant chapters for instructions on how to program them.

Setting the TalkOver mode and level

1 Go to the **Settings > Menu > Mic Setup > Setup** page to set the TalkOver parameters.

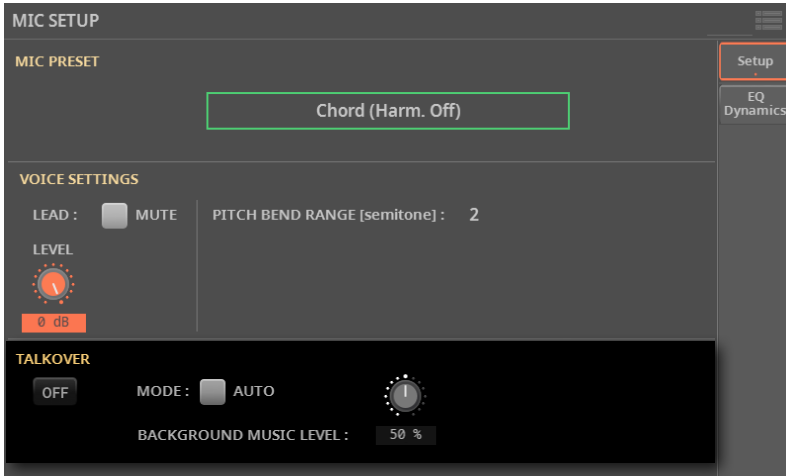

2 While in this page, use the **Mode > Auto** checkbox to choose between Manual and Auto TalkOver.

When in **Auto** mode, TalkOver will be automatically engaged when the Players are stopped. This way, you can talk to the audience between two songs, without having to touch the TalkOver **On/Off** button.

Use the **Background Music Level** control to set the level to which the volume of all Sounds (Keyboard, Players, Pad...) will be reduced when TalkOver is engaged. 100% corresponds to no level reduction.

Using the microphone effects and harmonization

The Mic Presets

The Mic effects can be saved into a **Mic Preset**. You can then select the preset, either by choosing them from the library, or by choosing a different SongBook Entry.

Choosing a Mic Preset

Choosing a Mic Preset from the library

- 1 Go to the **Home > Mic & Guitar** pane.

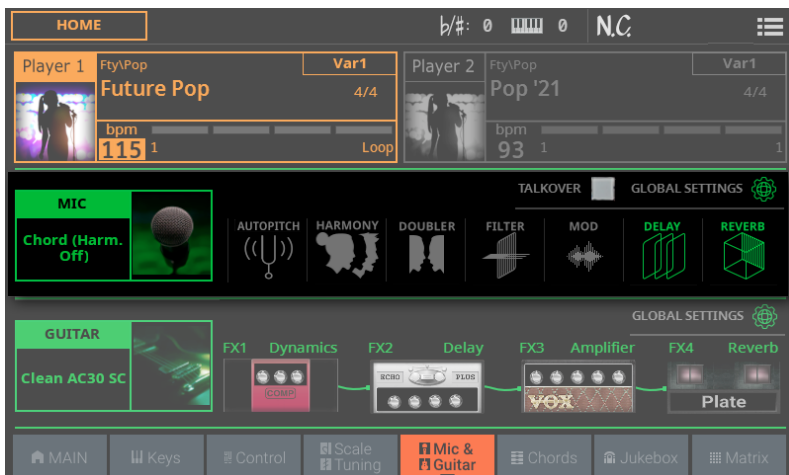

2 Touch the name of the Mic Preset to open the Mic Preset Select window.

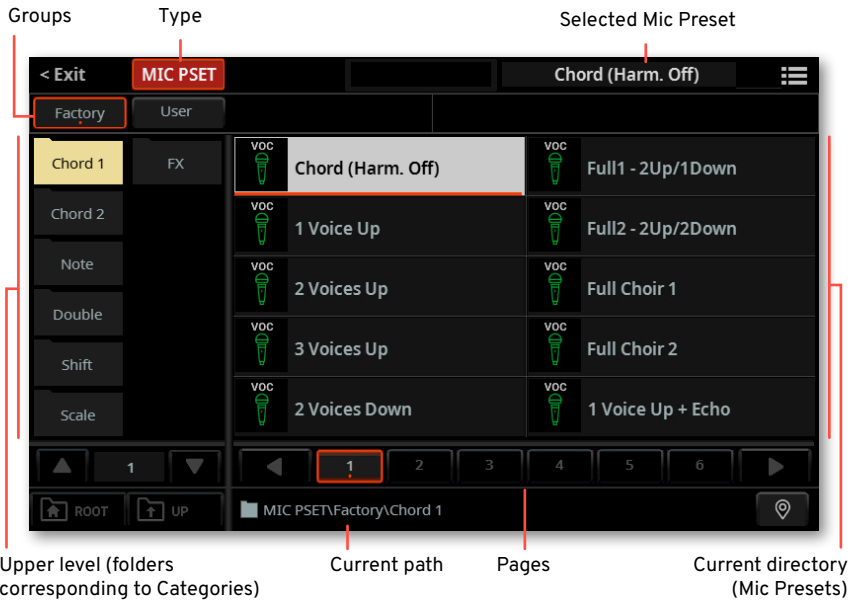

■ Choose a Mic Preset

1 To choose one of the available groups from which to choose a Mic Preset, touch the **buttons** in the second line at the top of the window.



Group	Meaning
Factory	Mic Presets included at the factory, that can't be modified.
User	Internal memory area where you can save new or edited Mic Presets, or where you can load or copy Mic Presets from an external storage device.

2 In case you want to choose a different category, touch one of the category folders in the left side of the **Mic Preset Select** window.

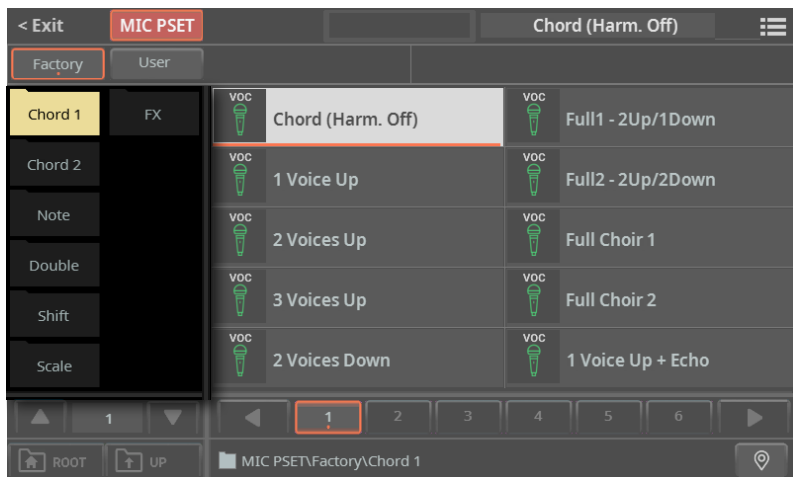

3 If not all the category folders can be seen in the current page, scroll through the page numbers to access the other folders.

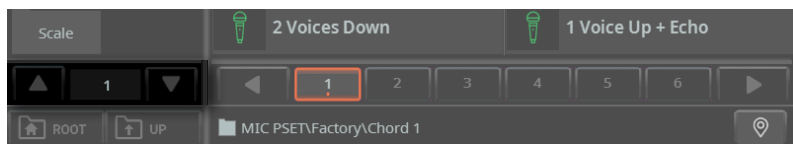

4 The Mic Presets contained in the selected folder appear in the right side of the window.

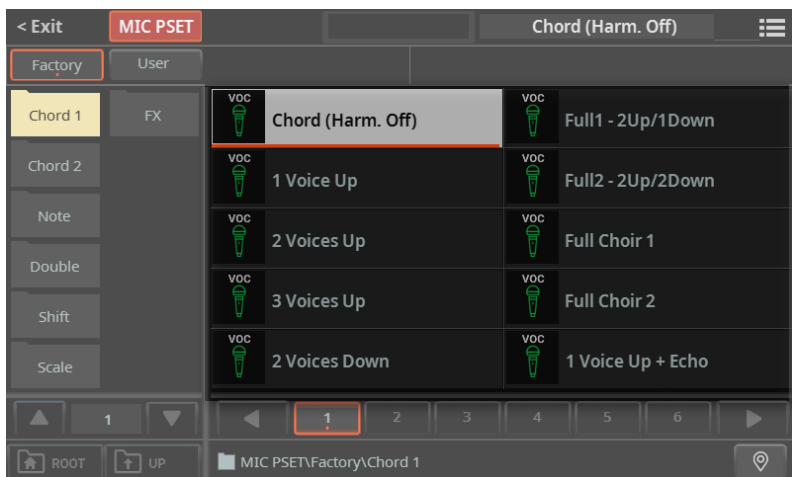

5 If the selected category folder contains more elements than the ones that can be seen in a page, browse through the pages. You can touch a **page number** to select it. Or use the **DIAL** or **UP/DOWN** buttons to move between the pages. If the pages are more than the ones that can be contained in the list, use the **left/right arrows** to scroll them in the display.



6 If you are lost while browsing through the data, you can return to the folder containing the selected element by touching the **Locate** (📍) button.

7 Touch the **name of the Mic Preset** you want to choose.

8 If you want to close the **Select** window (and it does not close by itself), press the **EXIT** button.

HINT: When a window does not close by itself, it means the **Display Hold** option is turned on. See [Display Hold](#) on page 67.

In the end, you will see the name of the selected Mic Preset in the dedicated area of the **Mic & Guitar** pane. The effects will change.

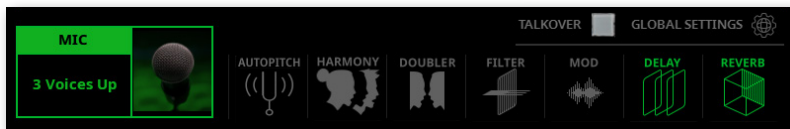

The **Global Settings** indicator will turn off, meaning that the current preset is the one you selected in the **Mic & Guitar** pane.

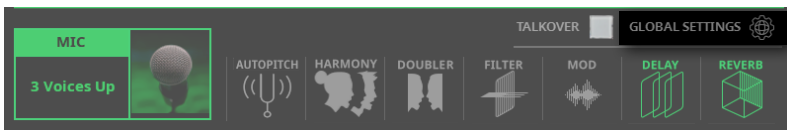

Choosing a Mic Preset with a SongBook Entry

When choosing a SongBook Entry, the Mic Preset might change. This will happen if the **Global Settings** checkbox in the **Home > Mic & Guitar** pane is not selected. The status of this parameter is saved in the SongBook Entry. If it is turned on, the global Mic Preset will be used.

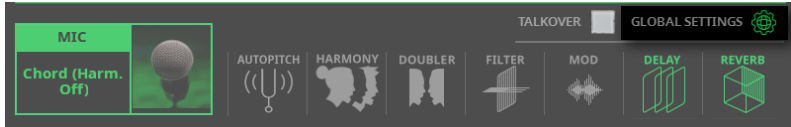

How to choose a global Mic Preset is described in [Choosing a global Mic Preset](#) on page 579.

Turning the effect modules on/off

A Mic Preset is made of several modules, each one specialized in a type of effect. You can turn each of the modules on off from the main page.

- 1 Go to the **Home > Mic & Guitar** pane.

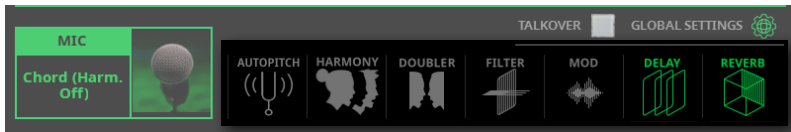

- 2 Touch each of the **modules** to turn them on or off. A deactivated module appears dimmed.

Mic Presets

Chord 1

Chord (Harm. Off)
 1 Voice Up
 2 Voice Up
 3 Voice Up
 2 Voice Down
 Full1-2Up/1Down
 Full2-2Up/2Down
 Full Choir 1
 Full Choir 2
 1 Voice Up+Echo

Chord 2

Wide Choir
 Higher Choir
 Gospel 1 (Male)
 Gospel 2 (Mixed)

Gospel 3 (Female)
 Close Choir
 Simple 2nd Voice
 2 Octaves Only
 Cathedral Choir
 2VoicesUp+Echo

Note

Notes Natural
 Notes Nat. Female
 Notes Nat. Male
 Notes Wide
 Notes No Lead

Double

2 x Double
 4 x Double

HighChoir+Doubl
 LowChoir+Doubl
 Doubler+Octave

Shift

Opera Octave Up
 Opera Octave Down
 Mixed Octaves
 Crazy Choir
 Unison Choir

Scale

Scale (3) C Maj
 Scale (3/5) C Maj
 Scale Full C Maj
 Scale (3) C min
 Scale (3/5) C min

FX

1 Up+Autopitch
 Another Brick
 Octave Child
 Octave Male
 Octave Female
 Panning+Delay
 Distorted Voice
 Chorus Voice
 Wah Vox
 Crazy Bot

'Global' and 'local' (or temporary) Mic Preset

You can choose a 'global' Mic Preset that does not change when choosing a different SongBook Entry. Or you can choose a 'local' Mic Preset that is better suited to the individual SongBook Entry.

You can choose a Mic Preset from the library (**Home > Mic & Guitar** pane). This 'local' Mic Preset is just temporary, and only becomes permanent when you save a SongBook Entry.

To change the type of Mic Preset, select or deselect the **Global** parameter in the **Home > Mic & Guitar** pane. This parameter is saved with each SongBook Entry.

GLOBAL SETTINGS 

Correcting your voice intonation

The Autopitch is optimized to produce corrective pitch correction as well as obvious effects made popular by a number of artists.

Choosing a Mic Preset with autopitch

All the Mic Presets include Autopitch. You may have to turn it on.

Turning autopitch on or off

- > Touch the **Autopitch** button in the **Home > Mic & Guitar** pane to turn it on/off.

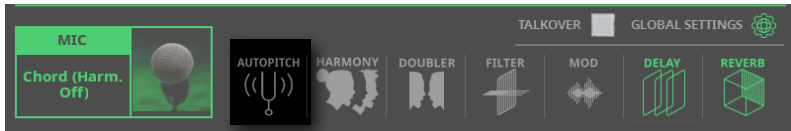

Harmonizing your voice

Harmonization adds a choir of voices to your lead voice.

Choosing a Mic Preset with harmony voices

> Choose a **Mic Preset** containing the desired harmony type, as described in the previous pages.

By default, these are some useful presets to test harmonization:

Mic Preset	Harmonization Type
Chord (Harm. Off)	Chordal harmonization, especially meant for Styles. You are expected to play chords on the keyboard (the recognition zone depends on the Chord Scan section). Chords are also received from the Chord Sequence.
Notes Natural	Polyphonic harmonization, especially meant for MIDI Songs. Notes are expected from the keyboard and/or from a track of the active MIDI Song (by default, Track #5).

Turning harmonization on or off

- > Use **BUTTON #2 (Mic Harmony On/Off)** to turn on/off the Harmony effect.



As an alternative, use the **Harmony On/Off** command you can find in the **Home > Control** page (with the **Main** view mode selected).

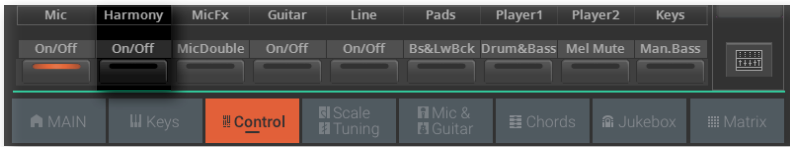

You can also turn it on/off from the **Home > Mic & Guitar** pane.

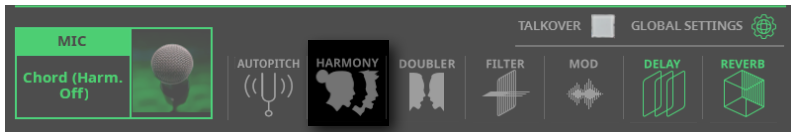

Adjusting the harmonization level

- Use **SLIDER #2 (Mic Harmony)** to adjust the harmony voices level.

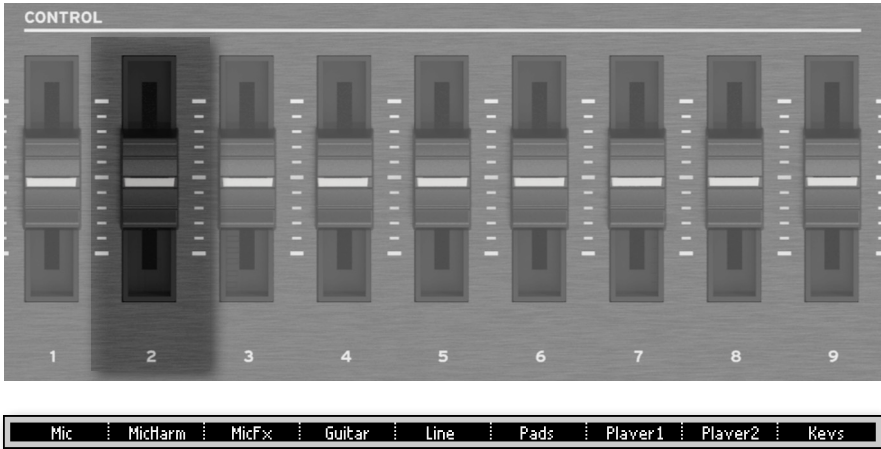

As an alternative, use the **Mic Harmony** control you can find in the **Home > Control** page (with the **Main** view mode selected).

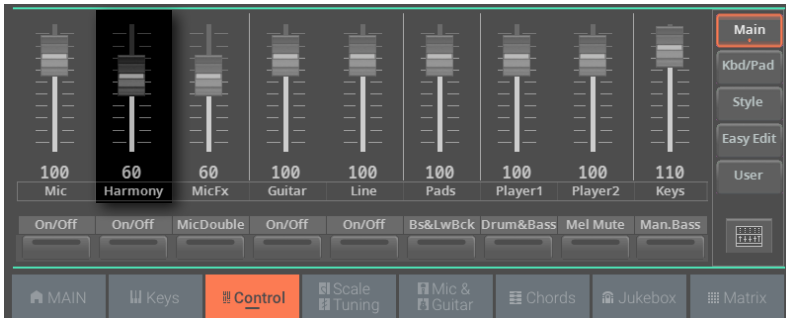

Playing harmony

- 1 Play the keyboard. Depending on the chosen harmonization type, you will play chords or separate melody lines.
- 2 Sing along with the chords and melody lines you play on the keyboard.

Where do chords and notes come from?

Each Mic Preset contains settings to choose the source of the chords or notes. Depending on the preset, you will play on the keyboard, and/or let the MIDI Song send notes from a track selected from the preset.

You can find more information in the section dedicated to programming the Mic Presets (see [Choosing a global Mic Preset](#) on page 579).

Doubling your voice

Doubling adds a second, subtly modified voice to your lead voice, making it thicker and stronger.

Choosing a Mic Preset with doubling

- Choose a **Mic Preset** containing the desired doubling type, as described in the previous pages.

Turning doubling on or off

- Use **BUTTON #3 (Mic Double On/Off)** to turn on/off the Double effect.



As an alternative, use the **Mic Double On/Off** command you can find in the **Home > Control** page (with the **Main** view mode selected).



You can also turn it on/off from the **Home > Mic & Guitar** pane.

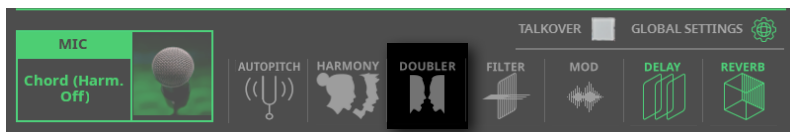

Playing the doubling voice

- Just sing to hear your voice and the doubling voice.

Using the effects

Effects can add modulation, ambience, improve or transform your lead voice and the added voices.

Effect module	Meaning
Filter	Steep filters emulating the sound of radios, phones and devices that generally degrade the audio signal.
Mod	Subtle thickening of the voice. This effect does a faithful job of emulating classic detune, chorus, flanger and thickening sounds.
Delay	Delay effect. The delay is similar to an echo, and can have short or long repetitions depending on the selected Mic Preset.
Reverb	Reverb effect. This adds ambience to the voices, smoothing and blending them.

Choosing a Mic Preset with the desired effects

- > Choose a **Mic Preset** containing the desired effects, as described in the previous pages.

Turning the effects on or off

- > Touch the buttons in the **Home > Mic & Guitar** pane to turn each module on/off.

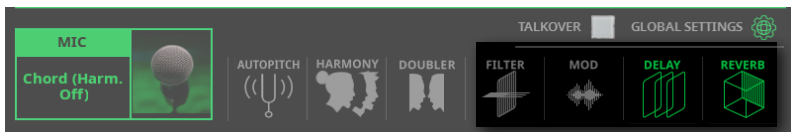

Adjusting the effects level

- > Use **SLIDER #3 (Mic FX)** to adjust the effects level.

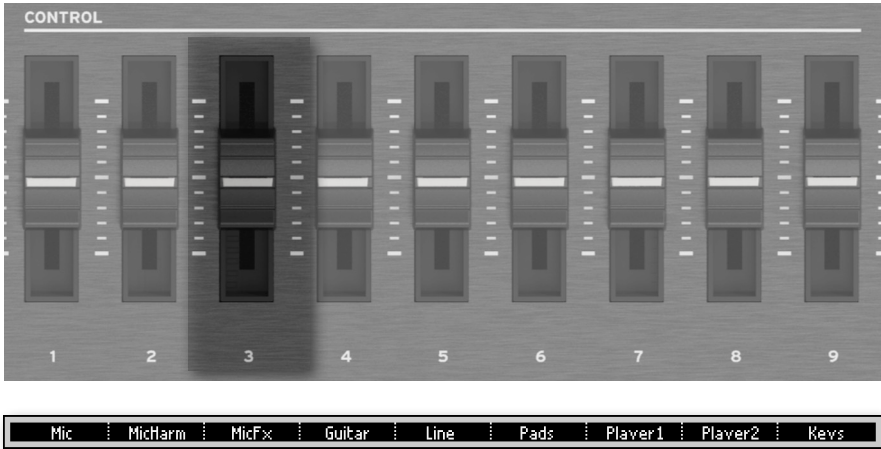

As an alternative, use the **Mic FX** control you can find in the **Home > Control** page (with the **Main** view mode selected).

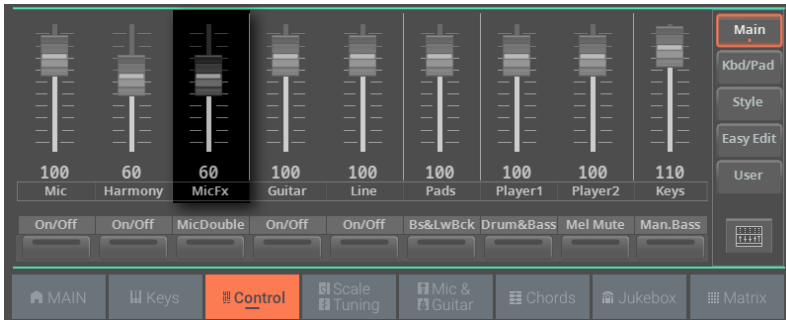

24

Guitar Input

Connecting a guitar

WARNING: Lower the master volume!

Before connecting or disconnecting something to one of the audio inputs, lower the **Master Volume** to zero. Preventing from doing it may damage the speakers and cause harm to your hearing!

Connecting a guitar and activating the guitar input

Connecting the guitar

Use the **GUITAR INPUT** connector to connect a guitar. This input can also be used for compatible instruments, like a bass guitar, or an acoustic guitar or oud equipped with a pickup. This is an unbalanced (TS) 1/4" (6.35 mm) jack connector.

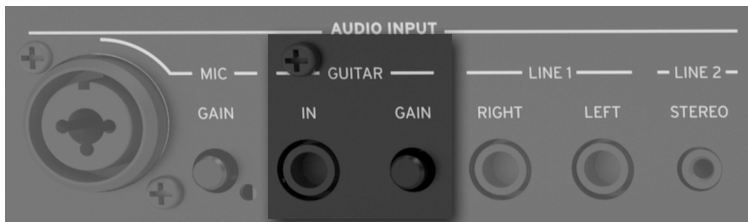

Turning on/off the guitar channel

- 1 Be sure the selected **CONTROL** mode is **MAIN**.
- 2 Use **BUTTON #4 (Guitar On/Off)** to turn the guitar channel on or off.

Please note that, for safety reasons, the input is always switched off when turning the instrument on.



As an alternative, use the **Guitar On/Off** command you can find in the **Home > Control** pane (with the **Main** view mode selected).



Routing the guitar to one of the audio outputs

By default, the guitar input is sent to the main Left and Right audio outputs. You can change the output routing to send it to any other output pair.

- > Go to the **Settings > Menu > Audio/Video > Audio In** page.
- > Set the **Guitar In > Audio Out** parameter to the desired audio output.

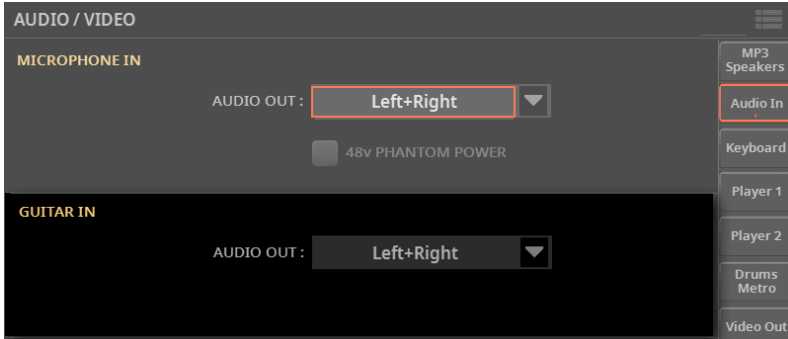

Audio Out	Meaning
Left+Right	Main LEFT and RIGHT outputs
Out 1+2	Separate sub-outputs 1-2
Out 3+4	Separate sub-outputs 3-4

Adjusting the guitar input gain

After having connected a guitar, adjust the input gain, to be sure it will not distort.

■ Preparation before starting adjusting the gain

- 1 Be sure the selected **CONTROL** mode is **MAIN**.
- 2 Use **BUTTON #4 (Guitar On/Off)** to turn on the guitar channel.

■ Adjust the gain

- 1 Use the **GAIN** knob next to the **GUITAR INPUT** connector to adjust the input gain (from 0 to +43 dB).



- 2 Play the guitar.
- 3 Check the input level in the **Settings > Menu > Guitar Setup > Setup** page.

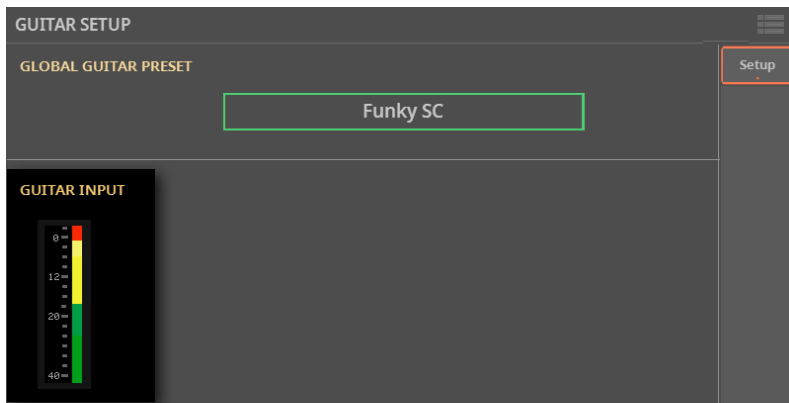

AUDIO IN color	Meaning
Off	No signal entering.
Green	Low- to mid-level signal entering. If the indicator turns off too often, the input gain is too low. Use the GAIN control to increase the input level.
Yellow	Slight overload in the signal path. This is fine if it turns on only on signal peaks.
Red	Clipping is occurring in the signal path. Use the GAIN control to lower the input level.

Keep the level so that this indicator remains green most of the time (even at signal peaks). For best results, keep the input level low (not exceeding -20 dB, as shown in the input meter). Guitars with a higher output level may overdrive more easily. Experiment with your own guitar.

Adjusting the guitar volume

The guitar input can be quickly turned on or off, and its volume in the mix adjusted, right from the control panel or from the main page.

- 1 Be sure the **Guitar** channel is turned on.
- 2 Be sure the selected **CONTROL** mode is **MAIN**.
- 3 Use **SLIDER #4 (Guitar)** to adjust the guitar channel volume.

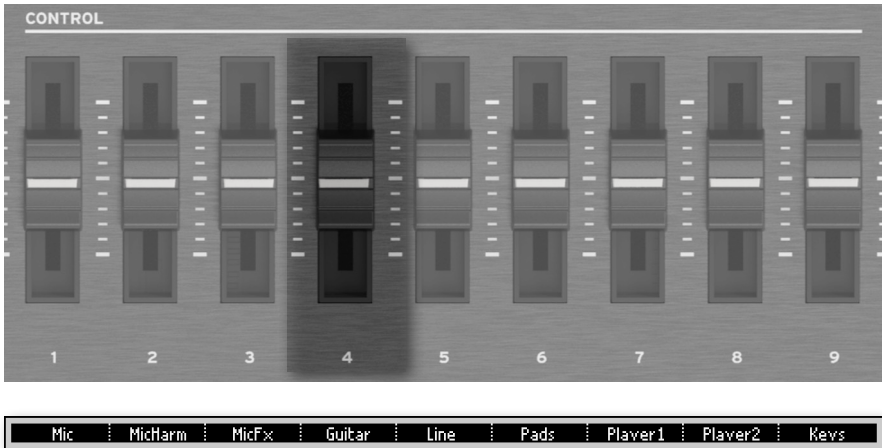

As an alternative, use the **Guitar Volume** control you can find in the **Home > Control** pane (with the **Main** view mode selected).

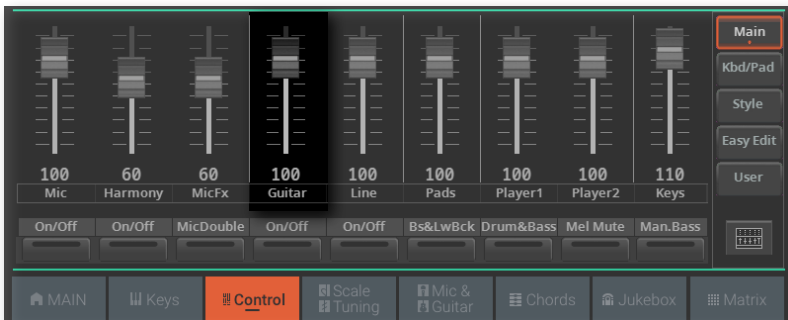

- 4 Start a Style or a Song to balance the guitar against the Sounds.
- 5 You can also adjust the input gain again, by using the **GAIN** knob next to the **GUITAR INPUT** connector.
- 6 Check that the audio is well balanced and is not distorting.

Shaping the guitar input

Choosing a global Guitar Preset

You can choose a global Guitar Preset that will be automatically selected when turning the instrument on.

- 1 Go to the **Settings > Menu > Guitar Setup > Setup** page.

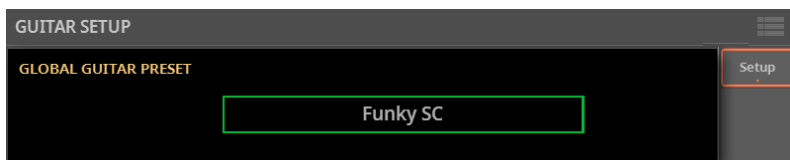

- 2 Touch the name of the selected **Guitar Preset** to open the **Guitar Preset Select** window.

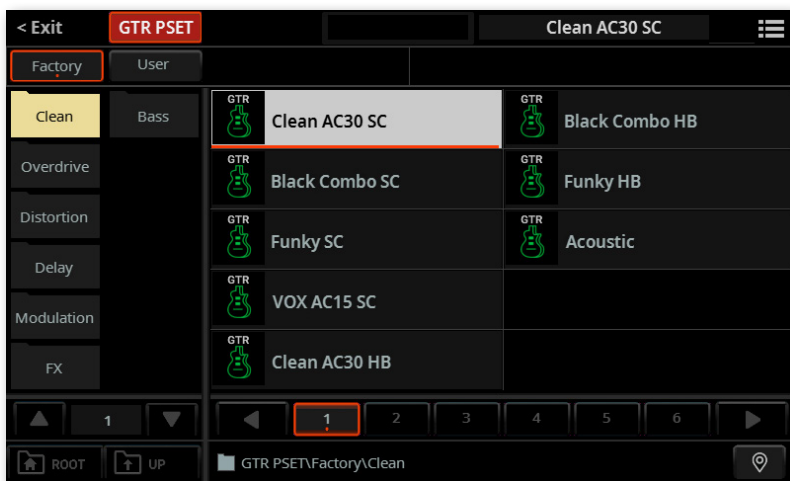

- 3 Choose one of the presets. For more details, see [Choosing a Guitar Preset](#) on page 611.
- 4 Press the **EXIT** button to close the **Select** window and confirm your selection.

Using the guitar effects

The Guitar Presets

The Guitar effects can be saved into a **Guitar Preset**. You can then select the preset, either by choosing them from the library, or by choosing a different SongBook Entry.

Choosing a Guitar Preset

Choosing a Guitar Preset from the library

- 1 Go to the **Home > Mic & Guitar** pane.



2 Touch the name of the Guitar Preset to open the **Guitar Preset Select** window.

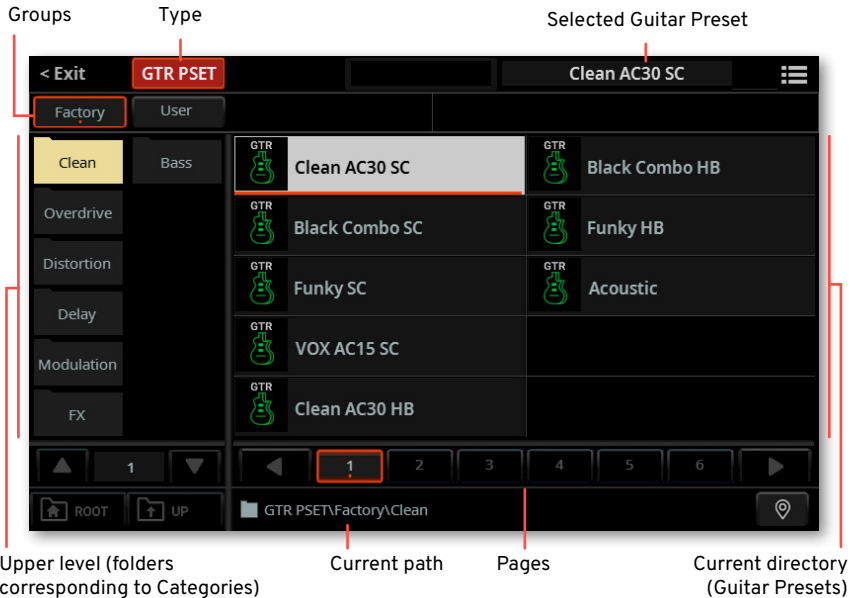

■ **Choose a Guitar Preset**

1 To choose one of the available groups from which to choose a Guitar Preset, touch the **buttons** in the second line at the top of the window.



Group	Meaning
Factory	Guitar Presets included at the factory, that can't be modified.
User	Internal memory area where you can save new or edited Guitar Presets, or where you can load or copy Guitar Presets from an external storage device.

2 In case you want to choose a different category, touch one of the category folders in the left side of the **Guitar Preset Select** window.

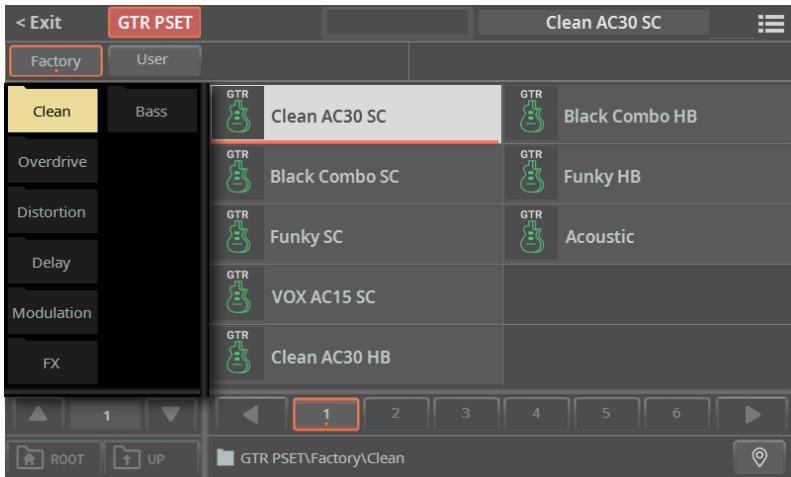

3 If not all the category folders can be seen in the current page, scroll through the page numbers to access the other folders.

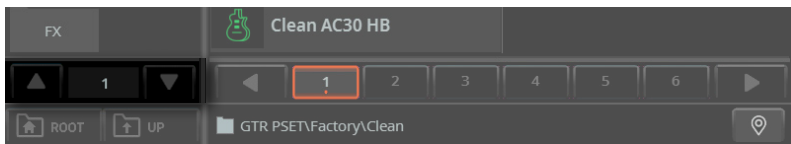

4 The Guitar Presets contained in the selected folder appear in the right side of the window.

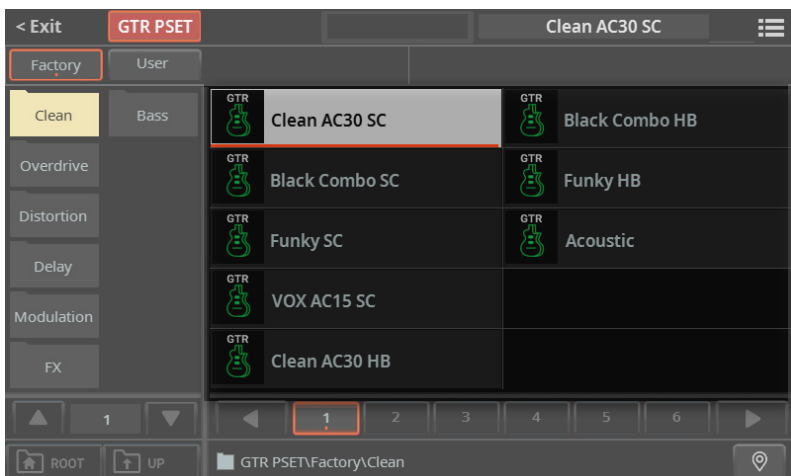

5 If the selected category folder contains more elements than the ones that can be seen in a page, browse through them. You can touch a **page number** to select it. Or use the **DIAL** or **UP/DOWN** buttons to move between the pages. If the pages are more than the ones that can be contained in the list, use the **left/right arrows** to scroll them in the display.

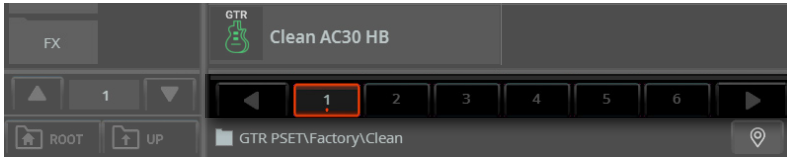

6 If you are lost while browsing through the data, you can return to the folder containing the selected element by touching the **Locate** (📍) button.

7 Touch the **name of the Guitar Preset** you want to choose.

8 If you want to close the **Select** window (and it does not close by itself), press the **EXIT** button.

HINT: When a window does not close by itself, it means the **Display Hold** option is turned on. See [Display Hold](#) on page 67.

In the end, you will see the name of the selected Guitar Preset in the dedicated area of the **Mic & Guitar** pane. The effects will change.

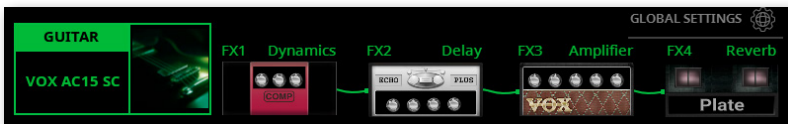

The **Global Settings** indicator will turn off, meaning that the current preset is the one you selected in the **Mic & Guitar** pane.

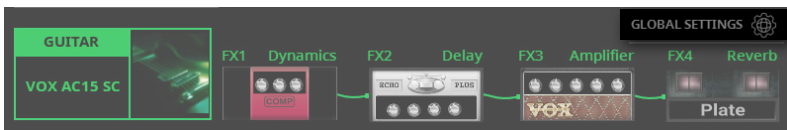

Choosing a Guitar Preset with a SongBook Entry

When choosing a SongBook Entry, the Guitar Preset might change. This will happen if the **Global Settings** checkbox in the **Home > Mic & Guitar** pane is not selected. The status of this parameter is saved in the SongBook Entry. If it is turned on, the global Mic Preset will be used.

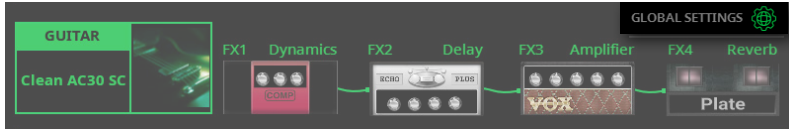

How to choose a global Mic Preset is described in [Choosing a Guitar Preset](#) on page 611.

Turning the effect modules on/off

A Guitar Preset is made of several modules, each one specialized in a type of effect. You can turn each of the modules on off from the main page.

- 1 Go to the **Home > Mic & Guitar** pane.

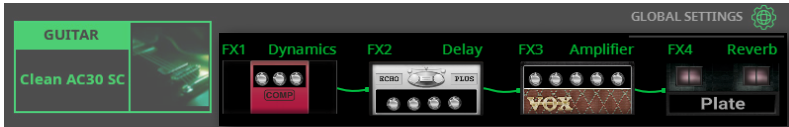

- 2 Touch each of the **modules** to turn them on or off. A deactivated module appears dimmed.

Guitar Presets

Clean

Clean AC30 SC
Black Combo SC
Funky SC
VOX AC15 SC
Clean AC30 HB
Black Combo HB
Funky HB
Acoustic

Overdrive

Overd AC30 SC
VOX AC15TB SC
UK Blues SC

Stone Combo
Overd AC30 HB

Distortion

Dist AC30TB SC
High Voltage
UK 80s HB
UK 90s HB
Dist AC30TB HB
Modded OD HB
Boutique HB
Big Lead

Delay

You2 Delay
Streets Name
Wall Delay
Clean BPM Delay
Ambient Tape Dly

Modulation

Combo Trem SC
Rotary
Stereo Chorus
Floyd Vibe
Orange Phaser
Classic Flanger

Classic Chorus
Pitch Shift Mod

FX

VOX Wah
Guitar Octaver
5th Below
Auto Reverse
Swell Delay
Pad Guitar

Note:

SC = Single Coil,
HB = Humbucker

'Global' and 'local' (or temporary) Guitar Preset

You can choose a 'global' Guitar Preset that does not change when choosing a different SongBook Entry. Or you can choose a 'local' Guitar Preset that is better suited to the individual SongBook Entry.

You can choose a Guitar Preset from the library (**Home > Mic & Guitar** pane). This 'local' Guitar Preset is just temporary, and only becomes permanent when you save a SongBook Entry.

To change the type of Guitar Preset, select or deselect the **Global** parameter in the **Home > Mic & Guitar** pane. This parameter is saved with each SongBook Entry.

GLOBAL SETTINGS 

Using the effects

A Guitar Preset is made of four effect modules. Each preset can include different types of effects.

Choosing a Guitar Preset with the desired effects

> Choose a **Guitar Preset** containing the desired effects, as described in the previous pages.

Turning the effects on or off

> Touch the buttons in the **Home > Mic & Guitar** pane to turn each module on/off.

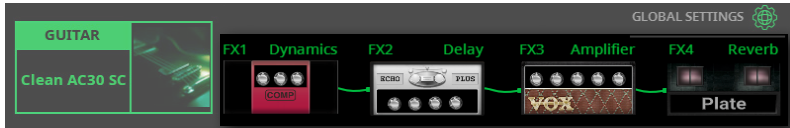

Controlling the effects via MIDI

You can control the guitar effects via MIDI, for example by connecting a MIDI pedalboard to the MIDI IN port of Pa5X.

■ Choose an appropriate MIDI Preset

First of all, check if there is an appropriate MIDI Preset. You can learn more about the available presets in the chapter dedicated to MIDI (see [Quick setup using the MIDI Presets](#) on page 513).

- 1 Go to the **Settings > Menu > MIDI > General Controls** page.

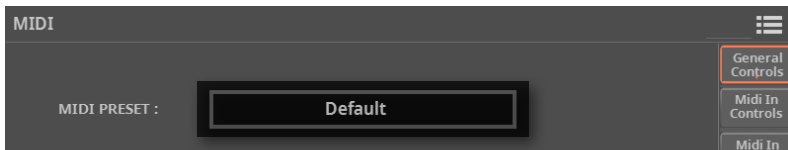

- 2 Choose a **MIDI Preset** matching your MIDI configuration.

■ Program the MIDI parameters

If you want to make your own custom settings, change some parameters.

- 1 Go to the **Settings > Menu > MIDI > MIDI IN Controls** page.

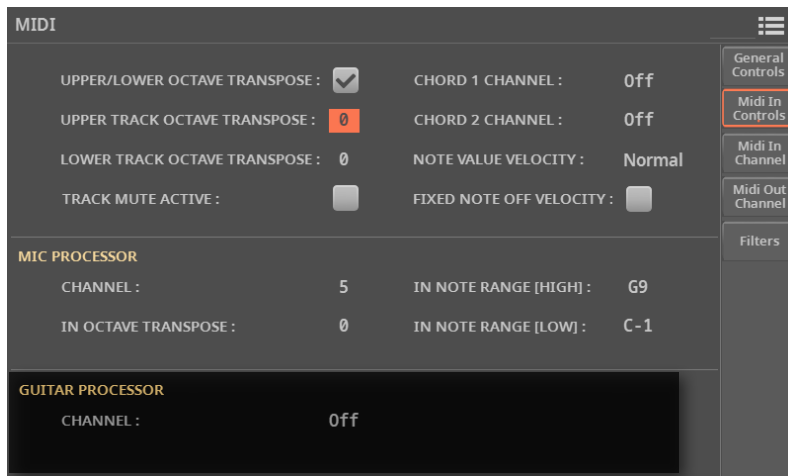

- 2 Use the **Guitar Processor > Channel** parameter to choose a MIDI channel on which to receive the control data.

25

Line Audio Inputs

Connecting a line audio device

WARNING: Lower the master volume!

Before connecting or disconnecting something to one of the audio inputs, lower the **Master Volume** to zero. Preventing from doing it may damage the speakers and cause harm to your hearing!

Connecting the line audio device

Use the **LINE INPUT** connectors to receive audio from an external device. These inputs are all line-level. Do not directly connect guitars, microphones or power amplifiers.

Warning: Connecting a power amplifier to these inputs will damage the instrument!

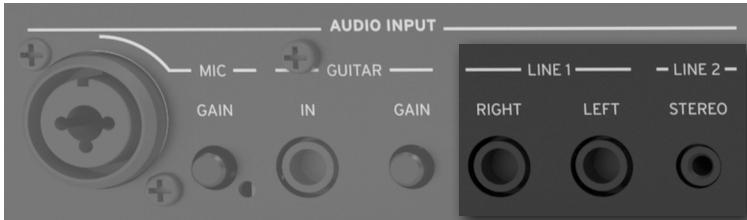

- > Use the **LINE 1 > LEFT** and/or **RIGHT** connectors to connect the audio outputs of another keyboard, the outputs of a voice or guitar effect processor, or the line outs of a stage mixer. Connect either of them to receive a mono signal. These are balanced (TRS) 6.35 mm, or 1/4", jack connectors.
- > Use the **LINE 2 > STEREO** mini-jack (3.5 mm, or 1/8") connector to connect an external media player (including a smartphone or a tablet).

Turning the line channel on/off

- 1 Be sure the selected **CONTROL** mode is **MAIN**.
- 2 Use **BUTTON #5 (Line On/Off)** to turn the line input channel on or off.

Please note that, for safety reasons, the input is always switched off when turning the instrument on.



As an alternative, use the **Line On/Off** command you can find in the **Home > Control** pane (with the **Main** view mode selected).



Routing the line input to one of the audio outputs

By default, the line input is sent to the main Left and Right audio outputs. You can change the output routing to send it to any other output pair.

- > Go to the **Settings > Menu > Audio/Video > Audio In** page.
- > Set the **Line In > Audio Out** parameter to the desired audio output.

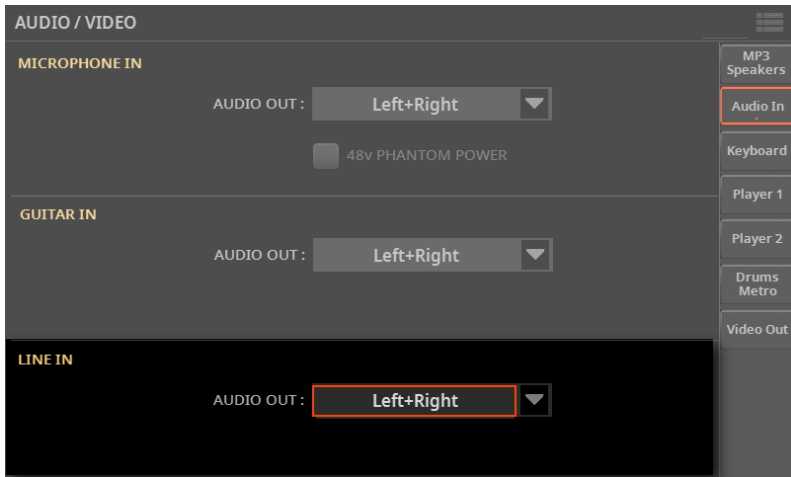

Audio Out	Meaning
Left+Right	Main LEFT and RIGHT outputs
Out 1+2	Separate sub-outputs 1-2
Out 3+4	Separate sub-outputs 3-4

Keep the level so that this indicator remains green most of the time, with orange appearing at signal peaks. Never go to red.

Adjusting the line channel volume

The line input can be quickly turned on or off, and its volume in the mix adjusted, right from the control panel or from the main page.

- 1 Be sure the **Line** channel is turned on.
- 2 Be sure the selected **CONTROL** mode is **MAIN**.
- 3 Use **SLIDER #5 (Line)** to adjust the Line channel volume.

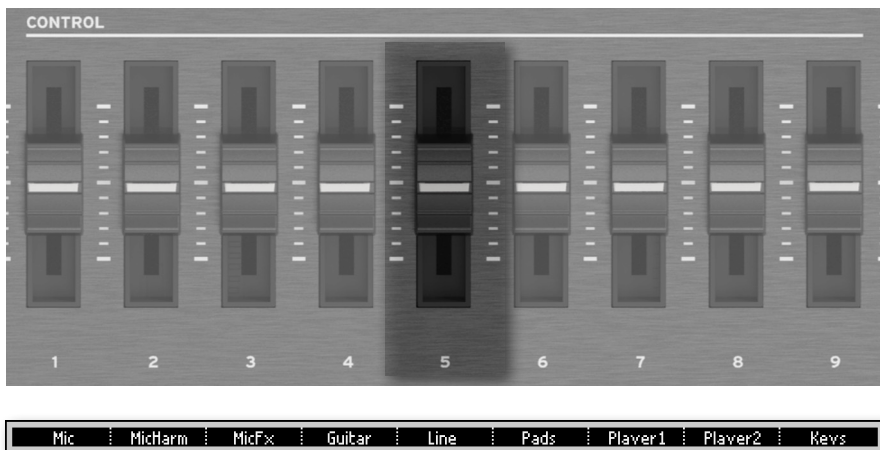

As an alternative, use the **Line Volume** control you can find in the **Home > Control** pane (with the **Main** view mode selected).

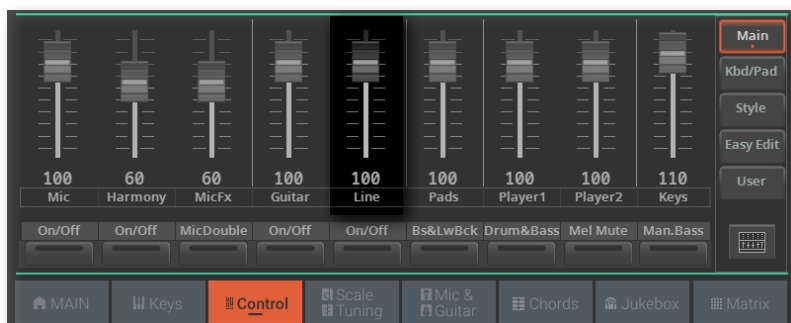

- 4 Start a Style or a Song to balance the audio input against the Sounds.
- 5 Check that the audio is well balanced and is not distorting. If needed, lower the output level of the Line source.

26

File, Search and Drives

Searching for files and other elements

Using the Search function

Depending on the page, you can search for different types of data. For example, while in the **File** pages you can only search for files, while in the **Home** pages you can search for several different types of data (Styles, Songs, Lyrics...).

The Search function is also available while a Select window is open. It is not available in all pages, since sometimes there are no relevant data to search for a particular page (for example, the **Settings** pages).

- **Access the Search window**
- > Press the **SEARCH** button to open the **Search** window.



■ Choose the type of data to look for

- > If needed, use the **What** menu to choose the type of item you are looking for.

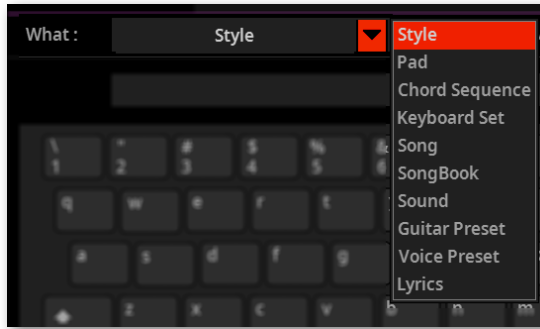

■ Choose a storage device and folder

When searching for some types of data, you can choose a storage device and folder where to do your search. When one of the allowed types of data is chosen, the **Browse** button will be enabled.

Searching in a storage device other than the internal memory is not allowed for Sounds, SongBook Entries, Microphone and Guitar Presets.

- 1 While in the **Search** window, touch the **Browse** button to open the **File Browser**.

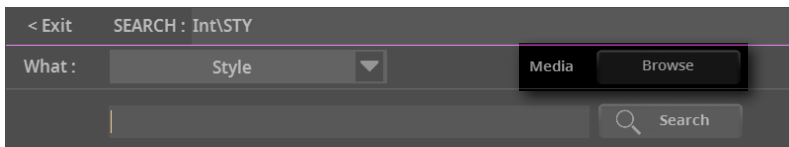

2 While in the **File** browser, touch the **storage device** on the left, and browse through the folders on the right. Touch a **folder** to open it. Touch the **Up** button to close the current folder and go to a higher level in the directory. Touch the **Root** button to return to the top level of the device.



3 When you have opened the **folder** containing the file you are looking for, press the **EXIT** button to close the **File** browser and return to the **Search** window. The name of the selected folder will be shown in the **title bar** of the **Search** window.



■ Type a text string and start searching

1 Type the **name of the item** you are looking for. There is no difference between upper and lower cases (“LOVE” is the same as “Love” or “love”).

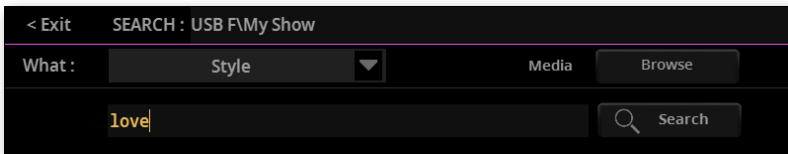

2 If you want to delete the full string, keep the **Backspace** button pressed.

- 3 When finished entering the name, touch the **Search** button. After a while, the list of items found in the selected place(s) will start showing on the display.

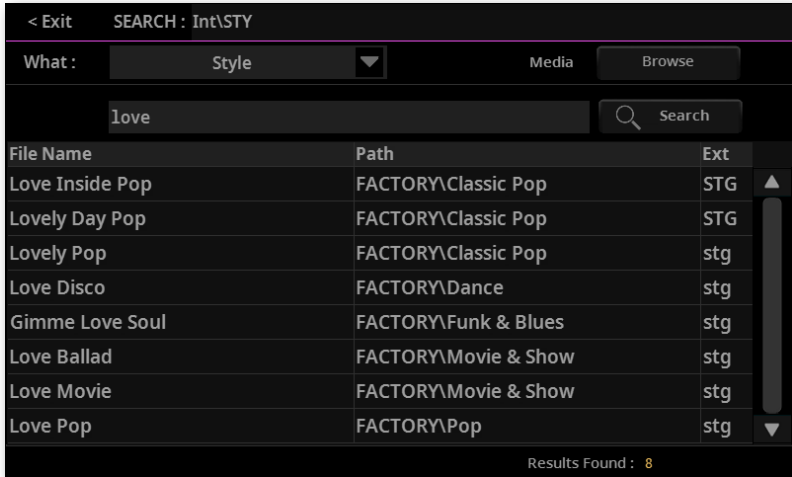

The time needed to complete a search depends on the type and size of the device(s) and the number of items.

Please wait for the current search to be completed, or touch the **Stop** button to stop the current search and do a new one.

■ Searching for a different text strings

- 1 Enter the new search string in the text field.
- 2 Touch the **Search** button again.

■ Select the item found and assign it to a Player

- 1 If you have found what you were looking for, touch its name in the list.
- 2 When choosing a Style, Song, Pad or Chord Sequence, a dialog will ask you to choose the target Player.



- 3 Choose the target **Player**. If you want to close this dialog without selecting anything, press the **EXIT** button instead.

Using musical resources directly from the drives

The Drive musical resources

You can choose Keyboard Sets, Styles, Pads and Chord Sequences from any internal or external drive. You can organize them inside ordinary folders, to create libraries of favorite resources directly read, for example, from an USB pendrive. There is no need to first copy them to the User area of the internal memory.

Creating your libraries in the drives

To put your musical resources into an ordinary folder, you can use either a personal computer or the dedicated functions of Pa5X. In Pa5X, you can find the **Copy and Paste** commands in the **page menu** (☰) of the **File** pages and the **Select** windows. (See [Copying and moving data](#) on page 665).

Choosing the musical resources in the drives

You can choose the Drive musical resources from any internal or external drive.

- 1 If you are reading from an external device, connect the device to one of the **USB HOST** ports.
- 2 Open the Select window for the resource you want to choose. While in the **Home > Main** page, touch the **name of the Style or Song** assigned to one of the Players. While in the **Home > Chord** page, touch the **name of the Chord Sequence**. While in the **Home > Menu > Pads** page, touch the **name of a Pad**.
- 3 In the **Select** windows, be sure the correct type of data is selected. For example, if you need the Styles, choose the Style type.



- 4 Touch the **Drives** button to select the corresponding group.

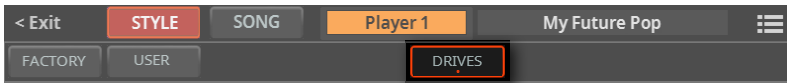

- 5 Select the **drive** containing the elements in the left side of the display.
- 6 Browse through the files and folders inside the selected drive.

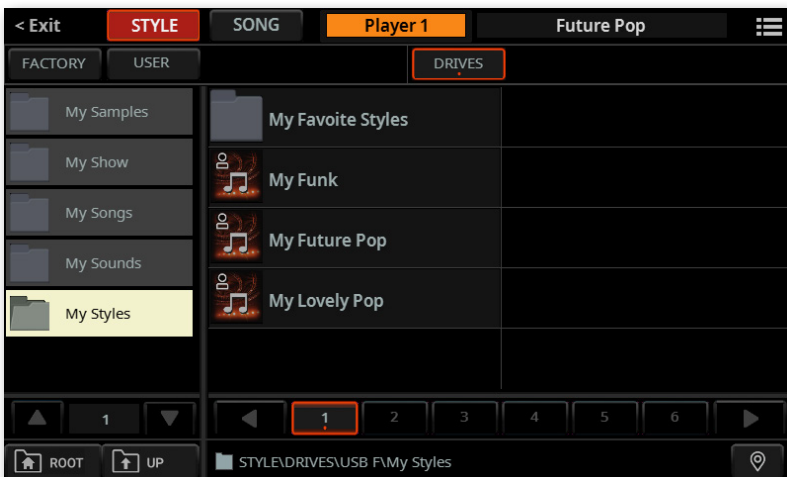

Overview on file management

You can access the **File** pages by pressing the **FILE** button. **File** pages are where you manage files and drives.

The File page structure

Most **File** pages share some basic elements.

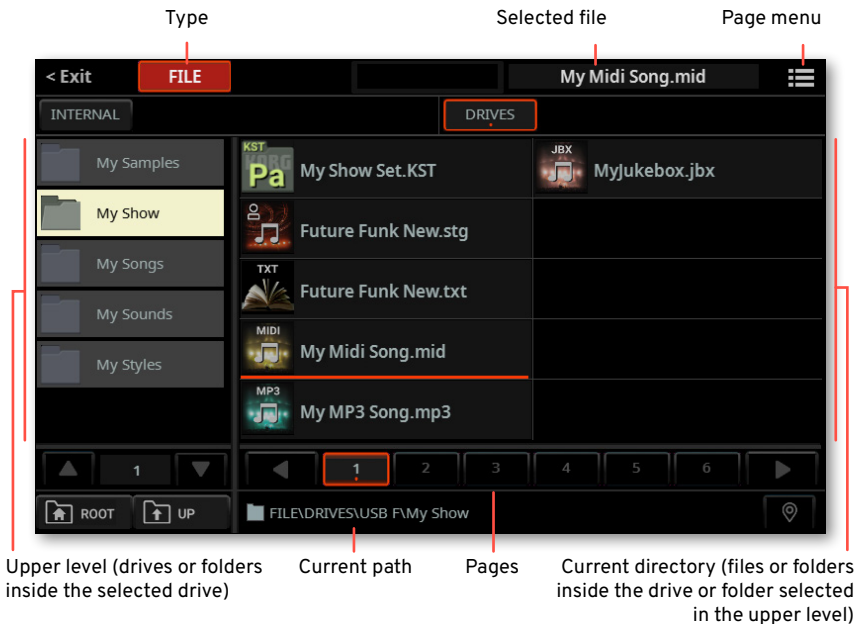

The drives and the internal memory

Choosing between the User area and the Drives

The **User area** of the **internal memory** is a space where Pa5X keeps the custom data that can be saved into a **KST folder**. These are, for example, the User Styles, Pads, Keyboard Sets, Sounds, SongBook Entries, Microphone or Guitar Presets, and other types of data.

The **Drives** are the storage devices where you can save data from the User area of the internal memory. Data will be saved into a KST folder. Among the drives is included the internal one called the **KORG DISK**, the drives connected to the **USB HOST** ports, and the **SD card**.

Data can also be directly used from the **Drives**, without first having to load them. You can play a Keyboard Set, a Style, a Pad or a Chord Sequence after having selected it from an ordinary folder inside one of the drives.

- > In a **File** page, touch the **Internal** button to see the content of the internal memory (the **User** area).
- > In a **Select** window, touch the **User** button to see the content of the internal memory.
- > Touch the **Drives** button to see the drives' content, and manage the data from the **KST folders** or from **ordinary folders**.



Selecting a drive

The first thing you see in the left side of the display, when choosing the **Drive** type of source, is a **list of the available drives**.

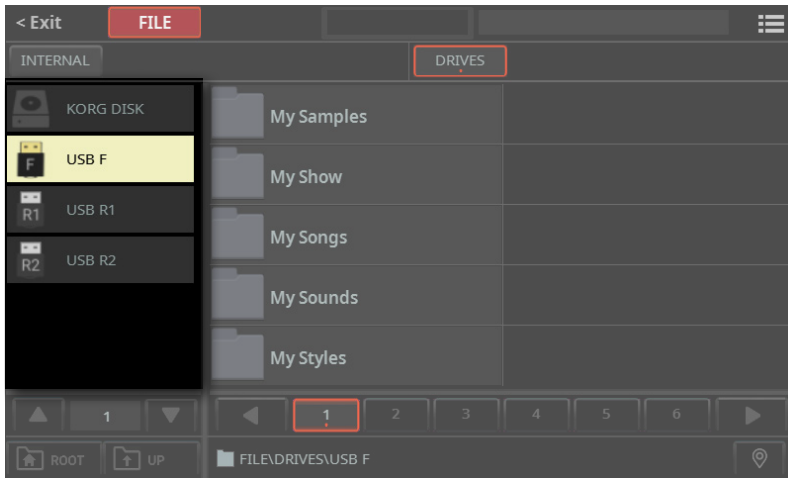

If not all of them can be seen in the current page, scroll through the page numbers to access the other drives.

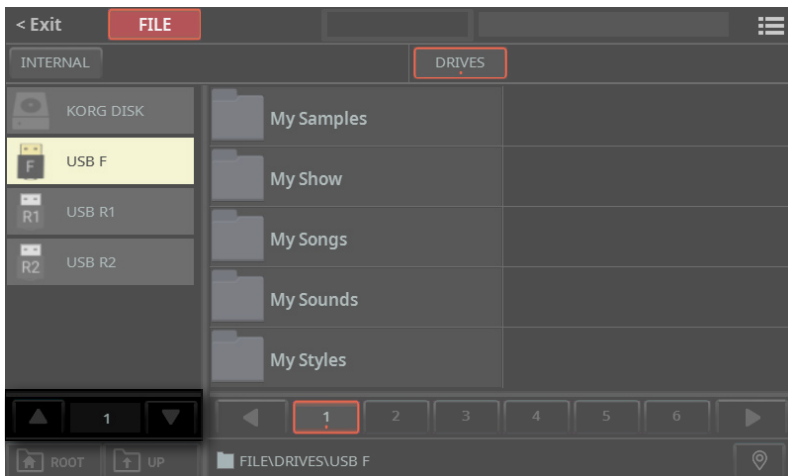

- > Touch the **name of the drive** to select it, and see its content in the right side of the display.
- > You can return to this list, after having gone deep into the folder hierarchy, by touching the **Root** button, or going up one step a time by touching the **Up** button.
- > You can return to the folder containing the latest selected file by touching the **Locate** (📍) button.

Supported device

Pa5X supports external devices, like hard disk drives or USB memory sticks, formatted FAT32 or FAT16 with long file names.

For maximum compatibility, we recommend to format an external device before saving data on it the first time (see [Formatting a drive](#) on page 680).

You can access the following storage devices:

Drive	Meaning
KORG DISK	Storage space inside the internal drive (separate from the User area)
SD USER	Storage space inside the (optional) SD card
USB F	Storage device connected to the front USB HOST port
USB R1	Storage device connected to the rear USB HOST 1 port
USB R2	Storage device connected to the rear USB HOST 2 port

Files, folders, directories

Browsing through the files and folders

You can see the files and folders on the right side of the **File** pages.

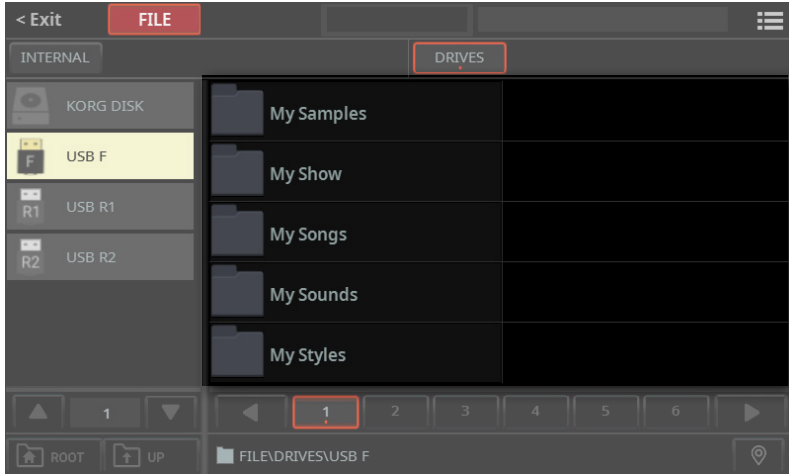

Under the elements, you can see the **page number selector**. Scroll through the different pages, if the elements are too many to fit in a single page. You can touch a **page number** to select it. If the pages are more than the ones that can be contained in the list, use the **left/right arrows** to scroll them in the display. Or use the **DIAL** or **UP/DOWN** buttons to move through the pages.

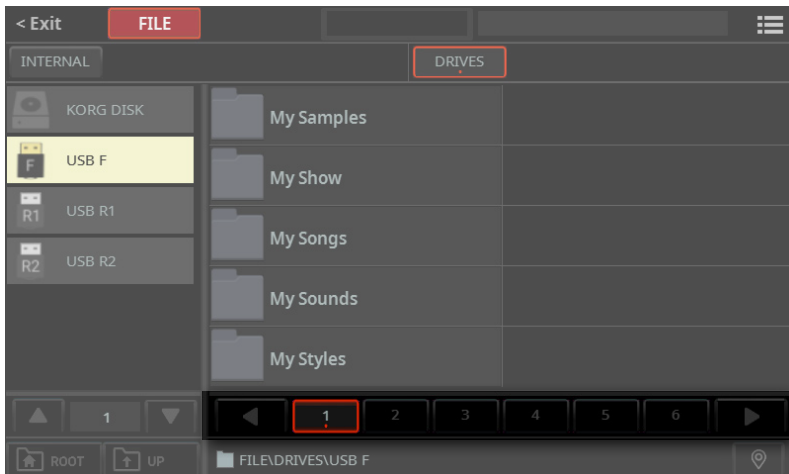

Current file path

The place in the drive you are currently exploring is always shown under the file list. This is called the **file path**.



Closing a folder and returning up

The two buttons next to the directory path allow for closing the current folder and going up in the drive hierarchy.



- > Go up one step by touching the **Up** button.
- > Return to the top level by touching the **Root** button.

Returning to the folder containing the latest select element

If you are lost through the folders while searching for a file, you can immediately return to the folder containing the latest selected file.



- > Return to the folder by touching the **Locate** (📍) button.

The files

Selecting and deselecting files

- Select a file or folder by touching it.

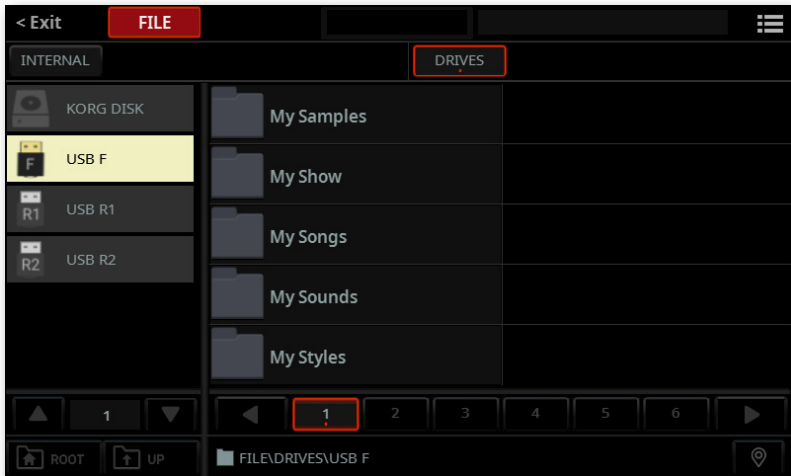

Selected drive (USB-F)

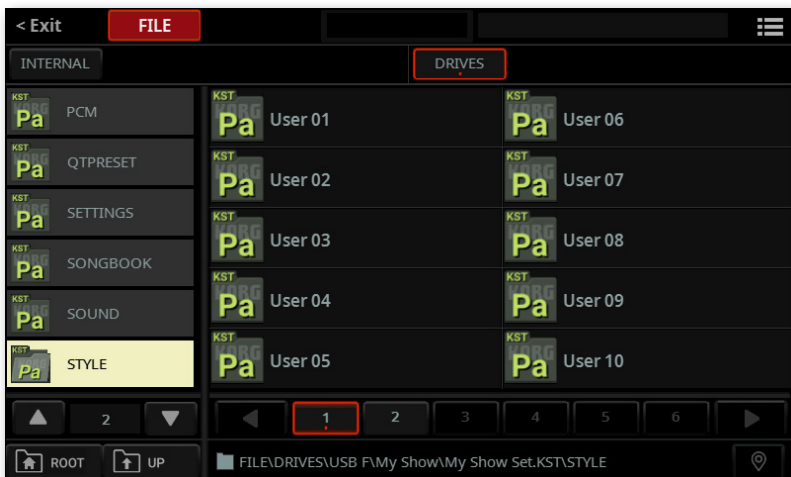

Selected folder (Style)

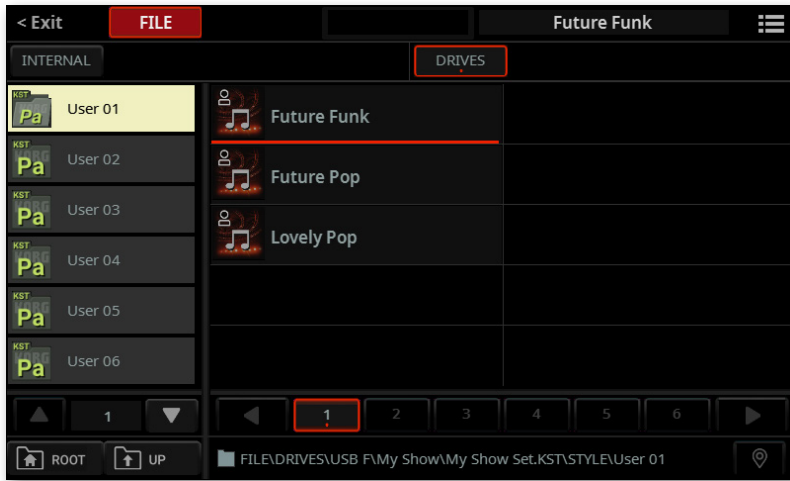

Selected file (Future Funk)

- > Deselect it by keeping the **SHIFT** button pressed, and touching the file to be deselected.
- > As an alternative, you can deselect any file by touching one of the **drives** or **folders** in the left side of the display. You can also touch again the open drive or folder.

Selecting multiple items at once

In some pages, you can select multiple items. Multiple selection is only allowed on the right side of the page.

To do it, select the first item, then press and keep the **SHIFT** button pressed while selecting the other items. When the last item has been selected, release the **SHIFT** button.

To deselect one or more items, keep **SHIFT** pressed and touch the item to be deselected. To deselect everything, touch the containing folder or drive in the left side of the display.

Selecting all the content of the current directory

- 1 While in the **File** pages, browse through the folders to open the one whose content you want to select.
- 2 Choose the **Select All** command from the **page menu** (☰) to select all the files and folders it contains.

Types of files

The following table describes all the file and folder types Pa5X can read or write.

Extension	File/folder type
KST	All the User data. This is a reserved folder containing other reserved folders.
KSC	Keyboard Set (from the library)
STG	Style
PDC	Pad
CSC	Chord Sequence (from the library)
MID	Standard MIDI File, SMF (MIDI Song)
MP3	MP3 file (MP3 Song)
JBX	Jukebox
TXT	Plain text file
SBD	SongBook's Book database (can only be used as part of the SongBook bundle)
SBL	SongBook's Set List (can only be used as part of the SongBook bundle)
GBL	Global Settings (can only be used as part of the Settings bundle)
MPR	MIDI Presets
QTP	Quarter Tone Scale Presets
VOC	Microphone Preset
GTR	Guitar Preset
MXP	MaxxAudio Preset
PCG	Sound
KMP	Multisample
PCM	Sample
AIF	AIFF audio files
WAV	WAVE audio files

Pa5X can also read (but not write) the following types of data.

Extension	File type
PKG	Operating System and Musical Resource files
KAR	Karaoke file
PCG	KORG Triton Programs
KMP	KORG Trinity/Triton Keymaps
KSF	KORG Trinity/Triton Sample
SF2	Sound bank format by Creative Labs

Ordinary data and reserved data

Each drive can contain **files** and **folders**. Drives (including the internal KORG DISK) are organized as computer drives. The User area of the internal memory is slightly more rigidly structured, due to the need of having the data always ready to play.

Some types of data are **freely organized** in the same way as files and folders in a computer, and you can see them listed in **alphabetical order**. These are the Keyboard Sets, Styles, Pads, Chord Sequences, and the Songs.

Some other types of data are organized in a **reference grid**. These are the Sounds, Mic Presets, Guitar Presets, MIDI Presets, as well as other types of data. These types of data have to be always found where expected by other types of data.

Empty locations

When saving items organized in a reference grid, empty locations are shown as three hyphens ('---'). This will allow for saving the element at a precise position in the reference grid.

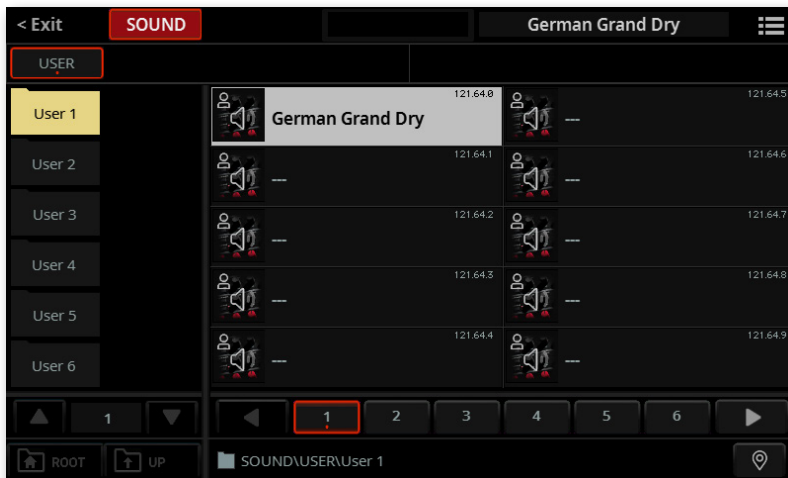

When saving items organized as individual files, they are saved in alphabetical order, with no need for a grid.



Page menu and file operations

When one or more files or folders are selected, you can choose a **command** from the **page menu** (☰) to execute an action on it or them (Load, Save, Copy...).

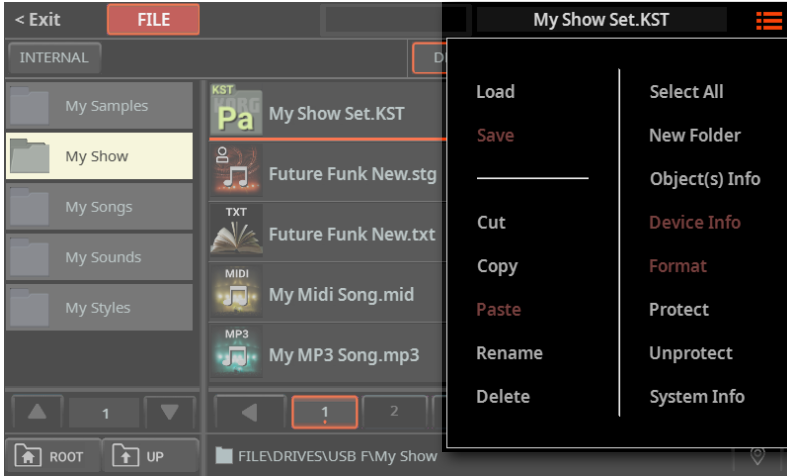

The commands are usually followed by a dialog, asking you to make additional choices, or just confirm.

The edit menu

Some global operations can be done in other pages of the **File** mode.

1 While in one of the **File** pages, press the **MENU** button on the control panel, and touch one of the buttons to choose the corresponding **edit section** of the **File** mode.

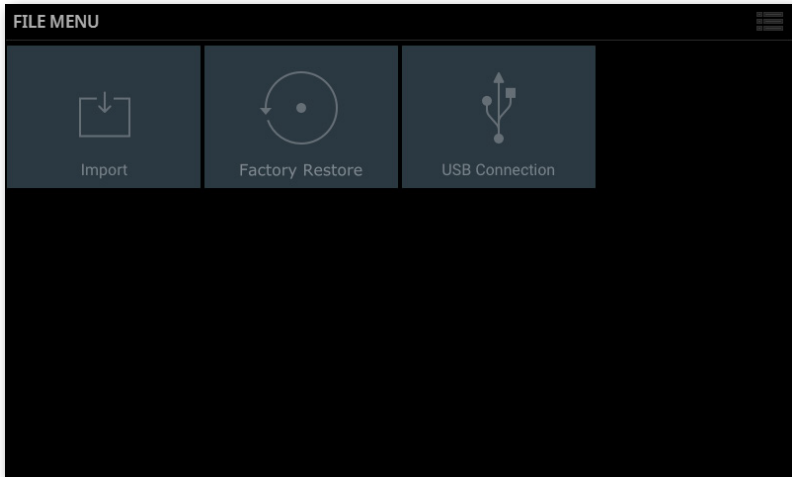

2 Press the **EXIT** button on the control panel to return to the **main page** of the **File** mode.

Loading Pa5X data from the drives

Loading from a KST folder

You can load a **KST folder**, or part of its content, into the **User** area of the internal memory. You can load the full memory content (a KST folder), a folder inside it (category), a folder inside a category folder (bank), or a single file from a bank. A bank may contain, for example, all the Keyboard Sets, or just a group of them (also a folder).

The KST folders can be contained inside ordinary folders in the drives.

You can load data into User folders, but not into Factory ones.

HINT: To load data from an older Pa-Series instrument, you have to first convert the SET folder (where the old content is saved) into a Pa5X KST folder by using the **File > Menu > Import** function. See later in this chapter.

■ Choose the data to be loaded

You will select from a drive the data to be loaded into the internal memory.

1 If you are loading from an external device, connect the device to one of the **USB HOST** ports.

- 2 Press the **FILE** button to see the main **File** page.

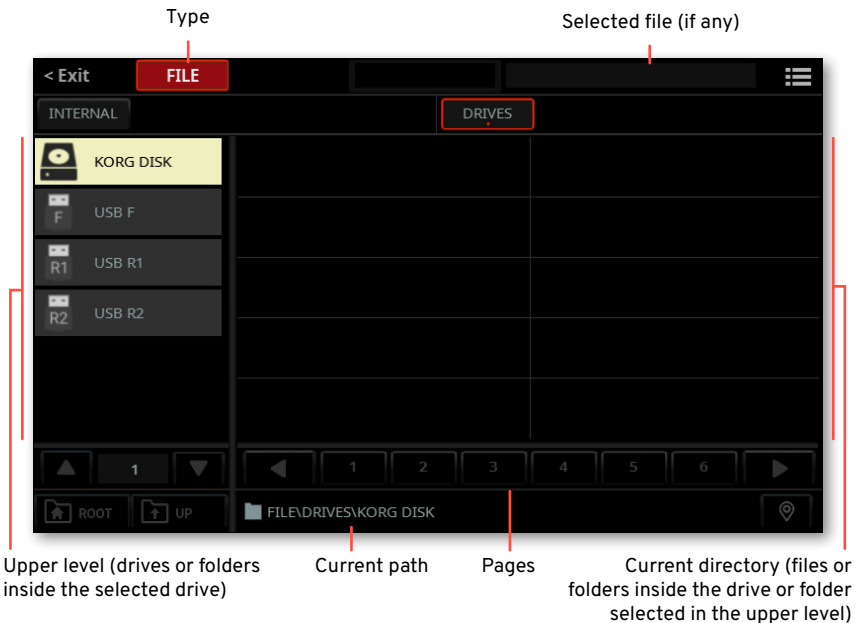

- 3 Touch the **Drives** button, to see the content of the internal and external drives. The image above shows a typical display of this page.

- 4 Browse through the folders. Touch a **folder** to open it. Touch the **Up** button to close the current folder and see the upper directory. Touch the **Root** button to return to the main directory of the drives.

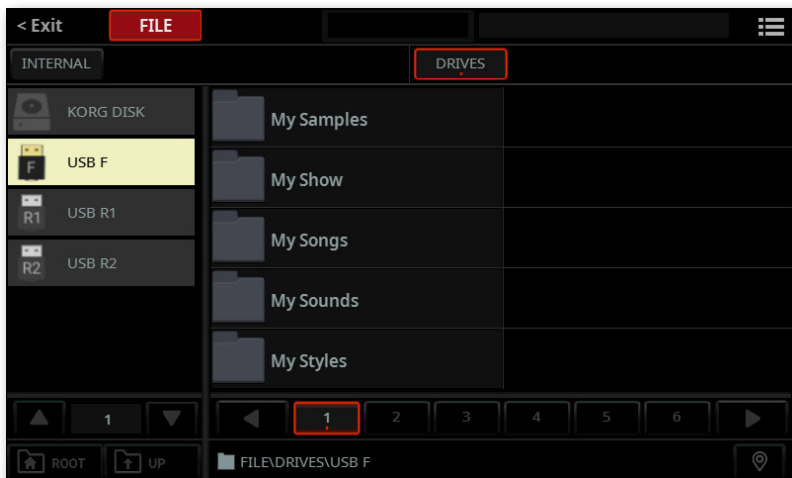

5 Touch a **KST folder** to see its content. In the following example, the “My Show Set.KST” folder has been selected. This folder contains all the User data of a Pa5X. In this situation, all the User files contained in the KST folder are selected.

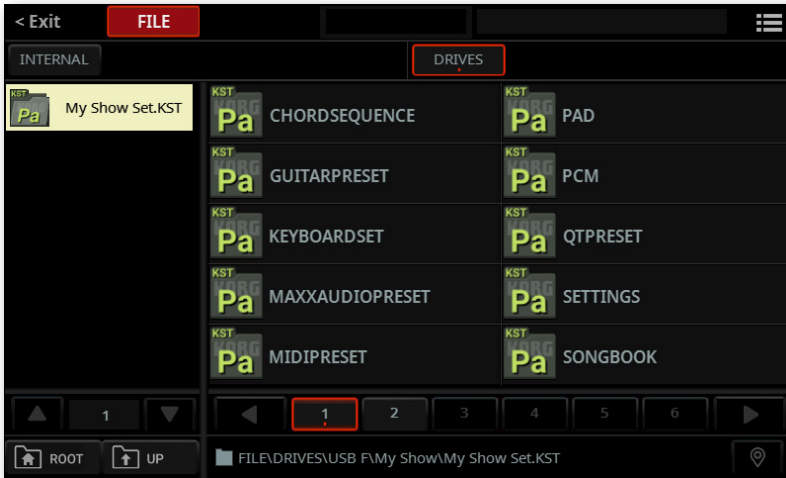

6 Touch a **type of data** to see all the available **banks** (folders containing individual elements in the internal memory). In the following example, the Style banks are shown. At this point, all the Style banks are selected.

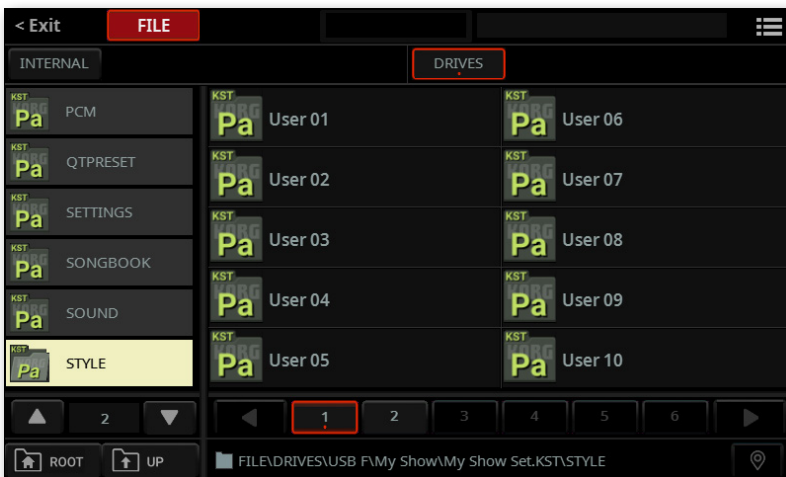

7 If you want to load a **bank**, touch it to open it, and see the individual files it contains. Don't touch any file in the folder. In this situation, the full content of the folder is selected. If you accidentally touch a file, keep the **SHIFT** button pressed and touch it again to deselect it.



8 If you want to load a **single file**, touch a folder to open it, and see the individual files it contains. When you see the file you want to load, touch it to select it. If you want to select multiple files, keep the **SHIFT** button while touching them.



■ Choose the Load command

> When the file or folder you want to load is selected, choose the **Load** command from the **page menu** (☰) to open the **Load** dialog.

■ Choose a destination

Once the source data has been selected, you can choose a destination in the **Load** dialog. The dialog that appears may vary, depending on the source data.

> The following dialog appears when the full **KST folder** has been selected, with no folder selected.

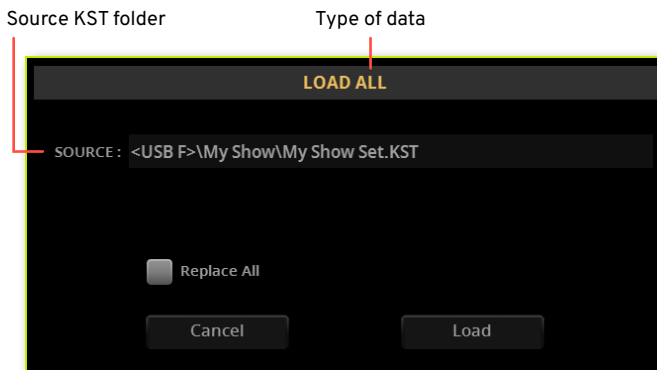

> The following dialog appears when a **type of data** (Style, Keyboard Set...) has been selected.

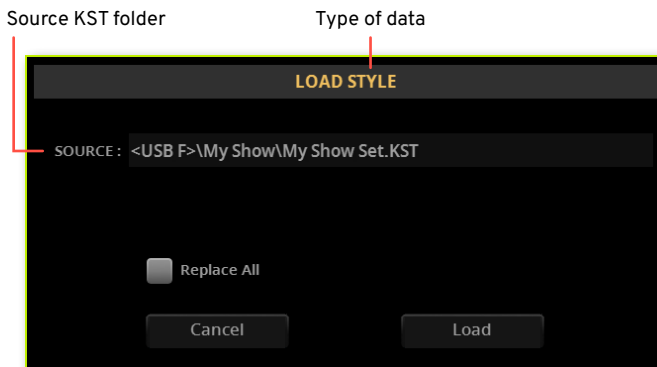

- > The following dialog appears when a **bank** (of Styles, Keyboard Sets...) has been selected.

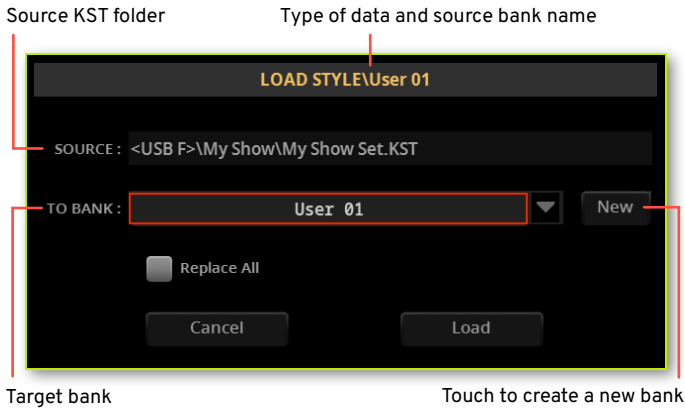

- > The following dialog appears when a **single file** has been selected.

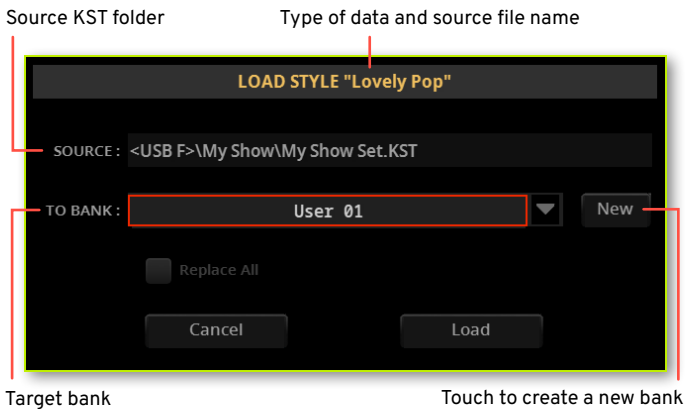

■ Merge or Replace the data at the destination

Choose whether you want to Merge or Replace the data.

- > If you **select** the **Replace All** checkbox, all the existing files of the selected type (Style, Keyboard Set...) in the internal memory will be replaced by the ones you are loading.
- > If the **Replace All** checkbox will remain **unselected**, the files you are loading will be merged with the ones already existing in the internal memory. Only the files with the same name will be replaced.

WARNING: Please note that replacing will delete all the data being replaced.

■ Load the data

- 1** Confirm loading.
 - > If you are happy with the **selected destination**, continue as it is.
 - > If you want to select a **different destination** in the internal memory, touch the down-pointing arrow next to the bank name, and choose a different bank.
 - > If you want to create a new bank, touch the **New** button.
- 2** Touch the **Load** button to confirm, or **Cancel** to stop the procedure. After confirming, any item you are overwriting will be deleted.

Loading data based on User Samples

When loading a KST folder containing Sounds based on User Samples, all User Samples in memory are deleted. If there are unsaved User Samples in memory, save them before loading the new ones.

To see if a KST folder contains User Samples, open it and check if a **PCM** folder is included.

If you want to load new User Sample without deleting the ones already contained in memory, load the individual Sounds instead of a whole KST folder.

What if loading User Samples is interrupted?

When you load User Sounds based on User Samples, you might reach the maximum size of the sample memory, or the maximum number of samples allowed in memory.

In this case, the Load operation is interrupted, and all the samples and multi-samples just loaded are removed from the memory. All the samples and multi-samples already contained in the memory before starting the Load operation are left untouched.

Merging User Samples from various sources

When you load a KST folder, all the User Samples in memory are deleted. To merge samples from several sources, do the following.

- 1 Load a KST folder containing samples you want to merge with other samples.
- 2 Load single Sounds from other KST folders.
- 3 Go to the Sample Edit mode, and load or import samples from other sources.
- 4 Save all the content of the memory over the same or a new KST folder.

Importing data from other instruments

Importing data from older Pa-Series instruments

You can import most data from older KORG Pa-Series instruments. Data from Pa4X, Pa1000, Pa700 can be converted for the most part.

Data from even older instrument may work, but there may be even more differences, that you'll have to carefully check and in some case adapt to the newer model.

Older Pa-Series instruments save their data into SET folders (equivalent to Pa5X's KST folders). You have to first convert the old instrument's SET folders into Pa5X's KST folders.

Please note that conversion times may be long. A progress bar will show the current situation on the display.

- 1 Press the **FILE**, then the **MENU** button to open the **File > Menu** page.

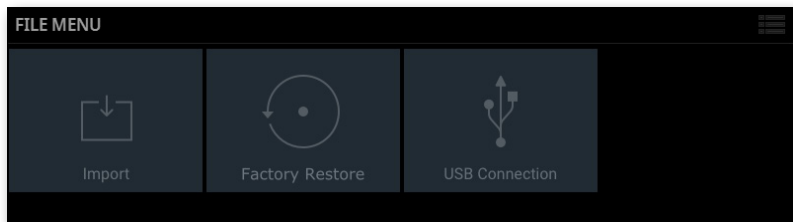

- 2 Touch the **Import** button to open the **Import** page.

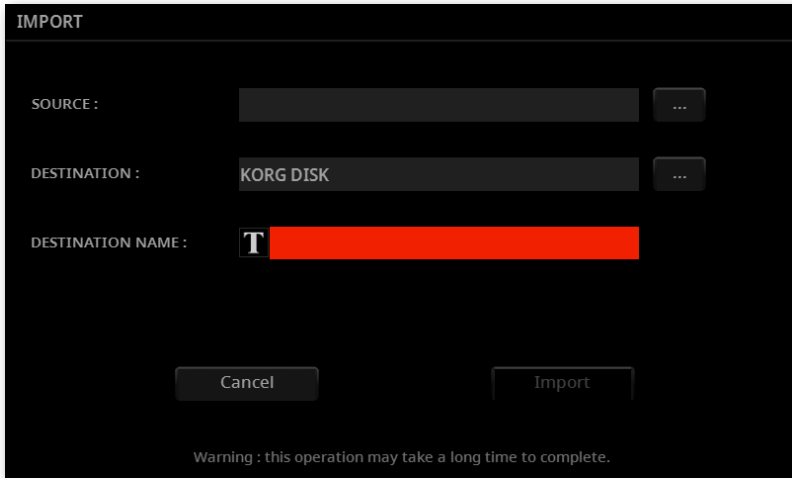

- 3 Touch the **Source > Browse (...)** button and choose the source **SET** folder.

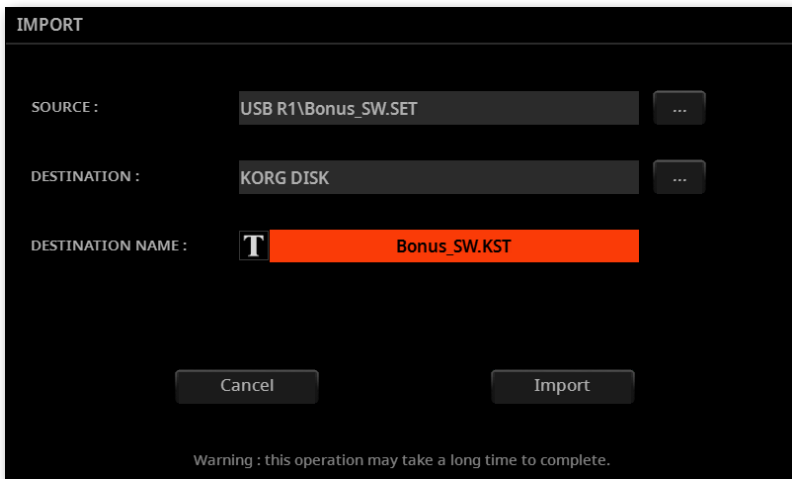

- 4 If you want to choose a different destination for the converted **KST** folder, touch the **Destination > Browse (...)** button to open the file browser.
- 5 Touch the **Text Edit (T)** button to open the **virtual keyboard** and edit the name. When done editing the name, confirm by touching the **OK** button under the virtual keyboard.
- 6 Touch the **Import** button, and wait for the files to be converted into the new format.

Saving Pa5X data to the drives

Saving to a KST folder

You can save the **User** area of the internal memory, or part of it, into a **KST folder** on a drive. You can save the full memory content (a KST folder), a folder (category) inside it, a group of elements inside the category folder (bank), or a single file from a bank.

The KST folders can be saved inside ordinary folders in the drives.

You can save User data, but not Factory data.

■ Choose the data to be saved

You will select from the internal memory the data to be saved into a drive.

1 If you are saving to an external device, connect the device to one of the **USB HOST** ports.

- 2 Press the **FILE** button to see the main **File** page.

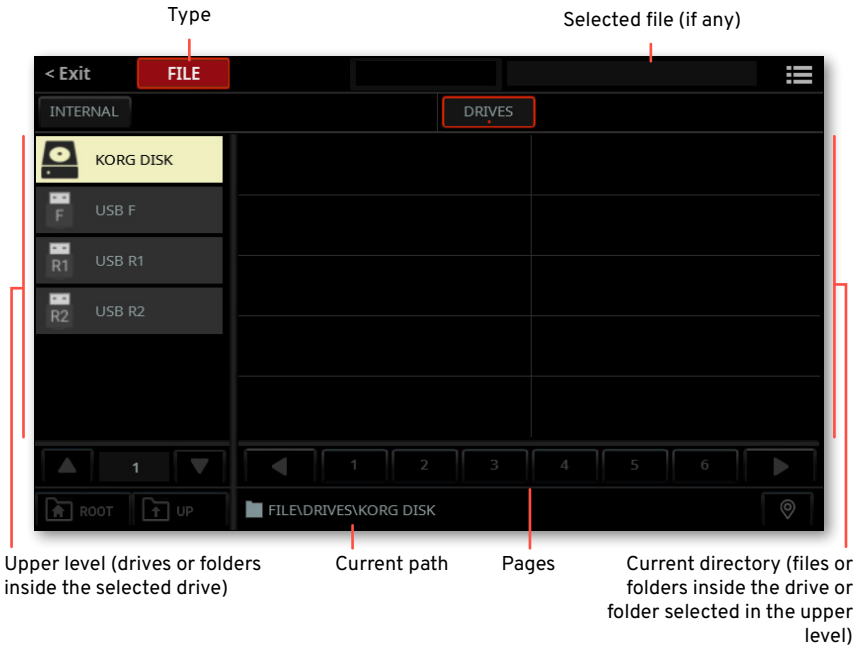

- 3 Touch the **Internal** button, to see the content of the User area in the internal memory. In this situation, all the User files contained in the internal memory are selected.

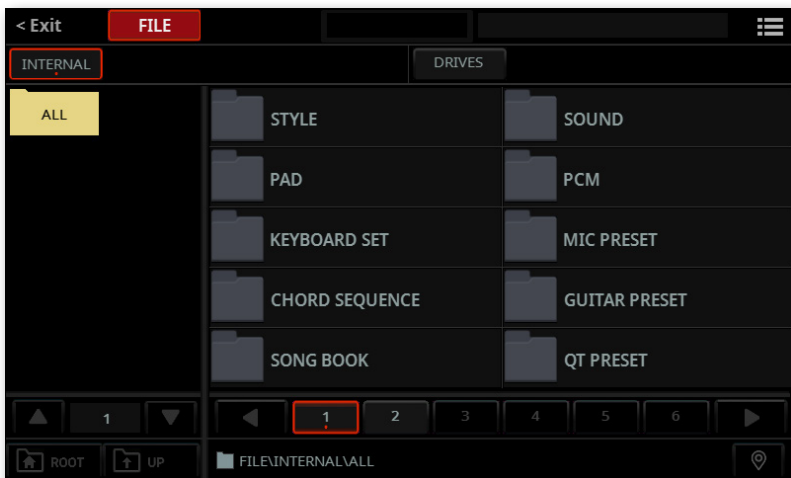

4 Browse through the folders. Touch a **folder** to open it. Touch the **Up** button to close the current folder and see the upper directory. Touch the **Root** button to return to the main directory of the internal memory (the “All” level).

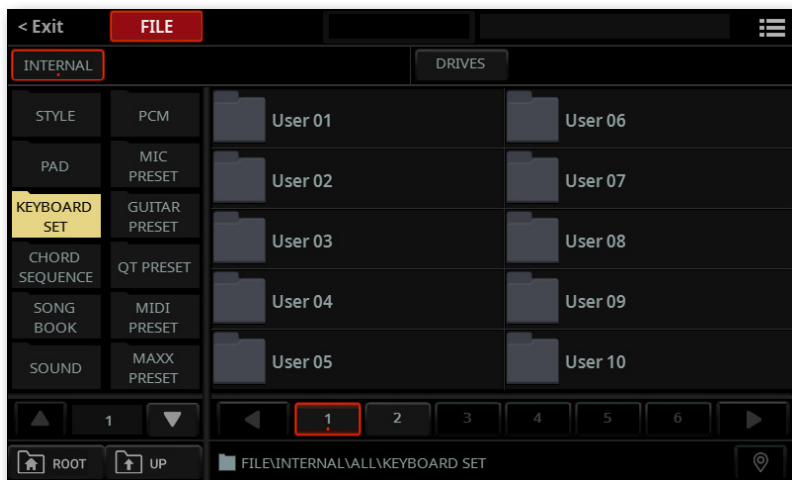

5 Touch a **type of data** to see all the available **banks** (folders containing individual elements in the internal memory). In the previous example, the Keyboard Set banks are shown. At this point, all the Keyboard Set banks are selected.

6 If you want to save a **bank**, touch it to open it, and see the individual files it contains. Don't touch any file in the bank. In this situation, the full content of the bank is selected. If you accidentally touch a file, keep the **SHIFT** button pressed and touch it again to deselect it.



7 If you want to save a **single file**, touch a bank to open it, and see the individual files it contains. When you see the file you want to save, touch it to select it. If you want to select multiple files, keep the **SHIFT** button while touching them.

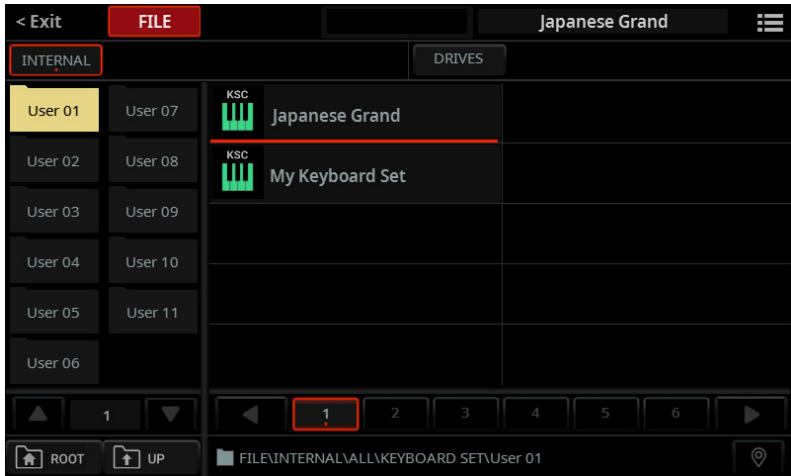

■ Choose the Save command

- 1 When the file or folder you want to save is selected, choose the **Save** command from the **page menu** (☰) to open the **Save** dialog.
- 2 If no target KST folder has been selected yet, a message will ask you to choose or create a new one.

Message warning no KST folder has been selected

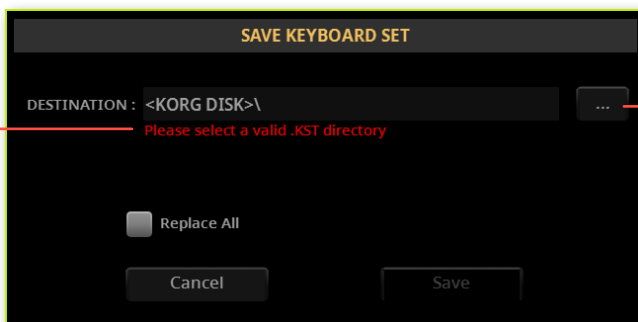

Touch to choose a target KST folder

■ Choose a target KST folder

3 Touch the **Select (...)** button to open the **Destination KST** window.

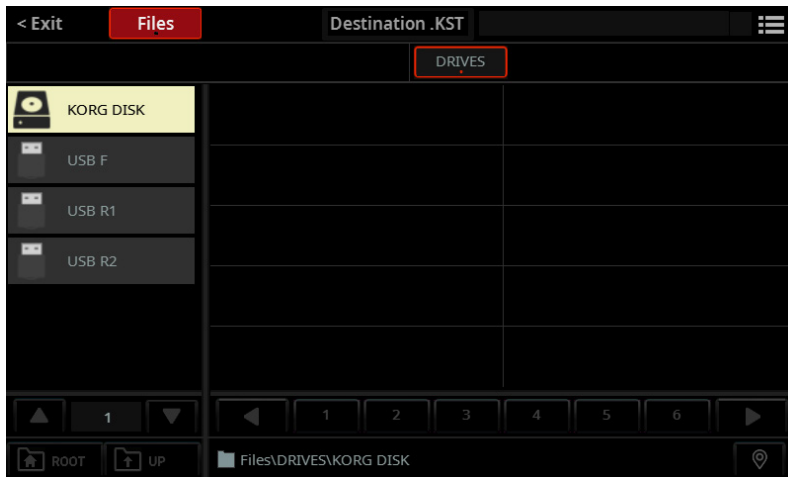

4 Touch the **target storage device** on the left, and browse through the **folders** to find the one where you want to save your data.

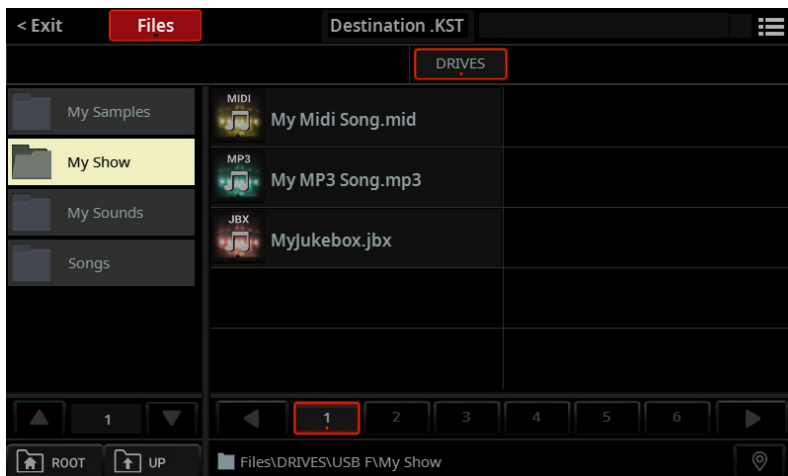

5 Touch the **KST folder** you want to choose as the target of the **Save** operation.

6 Press the **EXIT** button to return to the **Save** dialog.

■ Create a new KST folder

You can create a new, empty KST folder to save your data without overwriting anything.

1 While in the **Destination KST** window, choose the **Create New .KST** command from the **page menu** (☰). The **Create KST** dialog will appear.

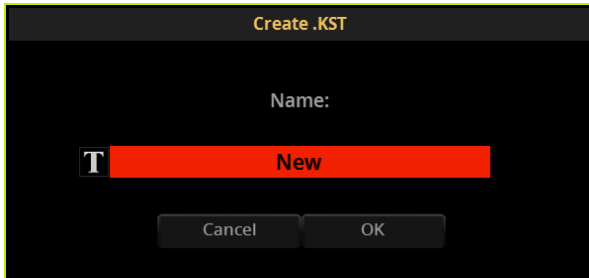

2 Touch the **Text Edit** (T) button to open the **virtual keyboard** and edit the name.

3 When done editing the name, confirm by touching the **OK** button under the virtual keyboard.

4 Press the **EXIT** button to return to the **Save** dialog.

■ Choose a destination

Once the source data and a target KST folder have been selected, you can choose a destination in the **Save** dialog. The dialog that appears may be different, depending on the source data.

> The following dialog appears when the **All** folder has been selected, with no folder inside it selected.

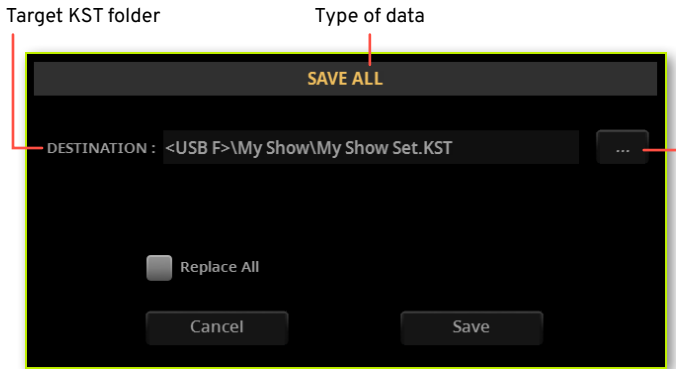

Touch to choose a target KST folder

> The following dialog appears when a **type of data** (Style, Keyboard Set...) has been selected.

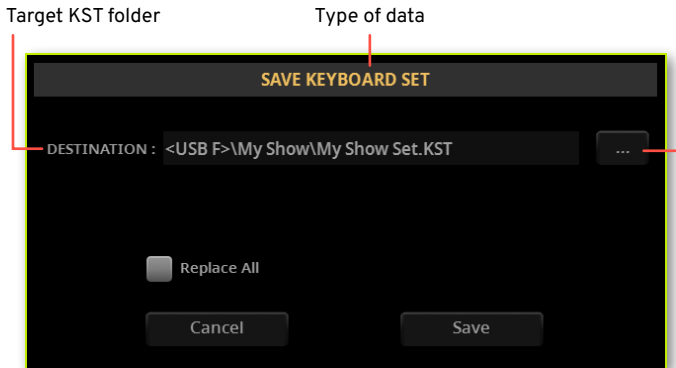

Touch to choose a target KST folder

- > The following dialog appears when a **bank** (of Styles, Keyboard Sets...) has been selected.

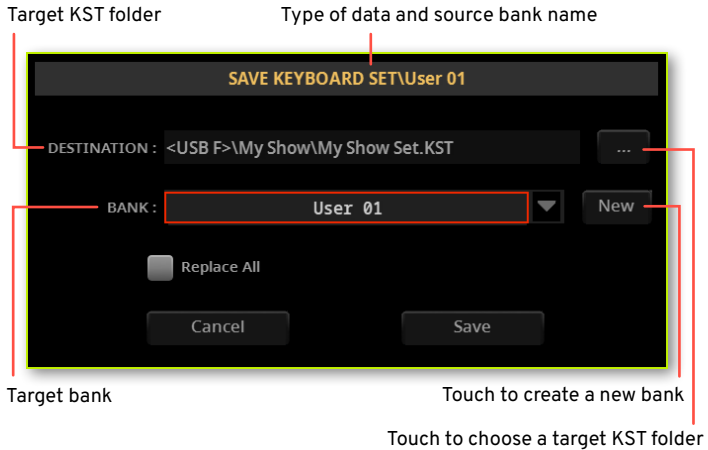

- > The following dialog appears when a **single file** has been selected.

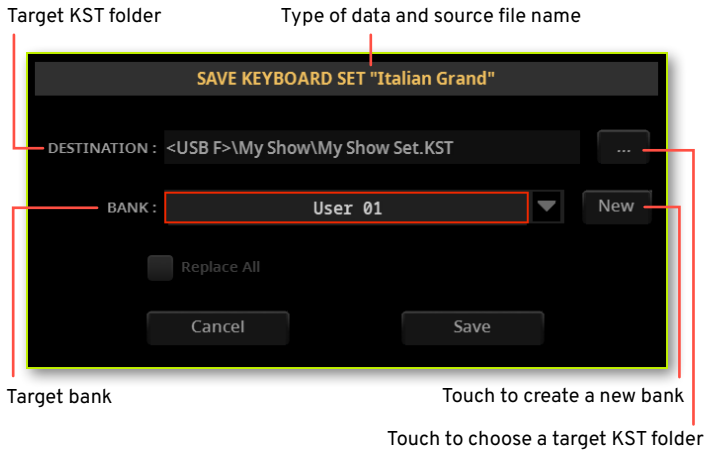

■ Merge or Replace the data at the destination

Choose whether you want to Merge or Replace the data.

- > If you **select** the **Replace All** checkbox, all the existing files of the selected type (Style, Keyboard Set...) in the target folder will be replaced by the ones you are saving.
- > If the **Replace All** checkbox will remain **unselected**, the files you are saving will be merged with the ones already existing in the target folder. Only files with the same name will be replaced.

Warning: Please note that replacing will delete all the data being replaced.

■ Save the data

1 Confirm saving.

- > If you are happy with the **selected destination**, continue as it is.
- > If you want to select a **different destination** in the target folder, touch the down-pointing arrow next to the bank name, and choose a different bank.
- > If you want to create a new bank, touch the **New** button.

2 Touch the **Save** button to confirm, or **Cancel** to stop the procedure. After confirming, any item you are overwriting will be deleted.

What if saving is interrupted?

If, when saving, there isn't enough free space in the target drive, the Save operation is interrupted. Any new KST folder you were creating will be removed. If you were saving over an existing KST folder, this is restored. No data will be saved.

Please choose a different (and bigger) target device, and repeat the Save operation.

Copying and moving data

User area, KST folders, ordinary folders

You can cut, copy and paste files in the **User** area of the internal memory and in the **Drives**, by using the dedicated **Cut**, **Copy** and **Paste** commands in the **page menu** (☰) of the **File** pages and the **Select** windows.

You can copy or move inside the **same drive**, or from a drive to a **different one** (both devices must be connected to Pa5X during the copy or move operation).

You can cut **User** data, but not **Factory** data. Copying and moving from the **User** area and the **KST folders** is subject to some limitations, due to the reserved structure of these folders. Due to these limitations, the **Cut** and **Paste** commands may not always be available.

Copying and moving from a Select window

While in a **Select** window, you can copy or move data of the type you are selecting (Keyboard Set, Style...). You have full access to the relevant data in the **User** area of the internal memory.

This is also where you can copy and move elements that are organized in a rigid structure, like the Sounds, Mic and Guitar Presets, or MIDI Presets.

■ Choose the data to be copied

- 1 If you are copying from or to an external device, connect the device to one of the **USB HOST** ports.
- 2 While in the **Home** pages, touch the **type of data** (Style, Keyboard Set...) you want to open in the corresponding **Select** window. The following example shows a **Style Select** window.

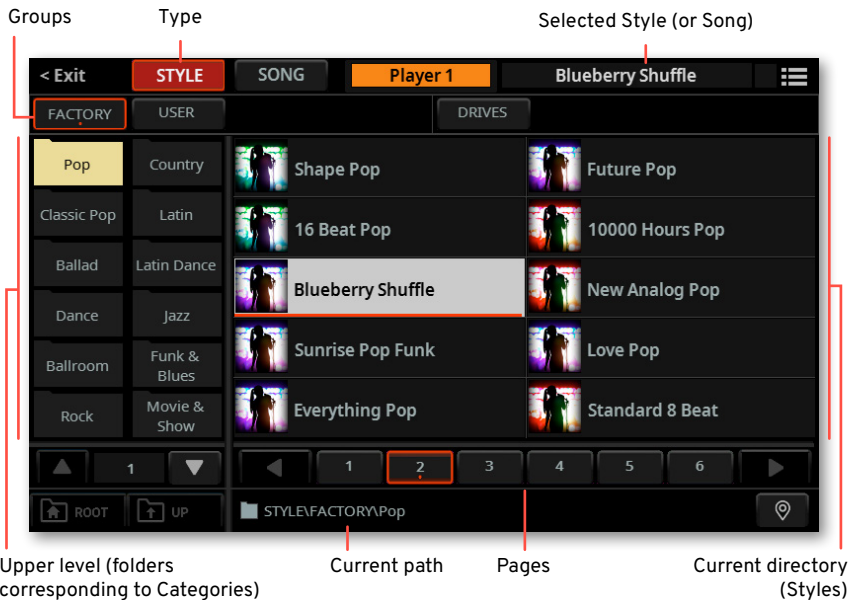

- 3 Touch the **Factory** button if the source is a Factory element in the internal memory, touch the **User** button if the source is a User element in the internal memory, or the **Drives** button if it is a folder in one of the drives.

Note: Factory data can't be cut.

■ Select the files

1 Browse through the folders (banks). Touch a **folder** to open it. Touch the **Up** button to close the current folder and see the upper directory. Touch the **Root** button to return to the main directory of the drives.

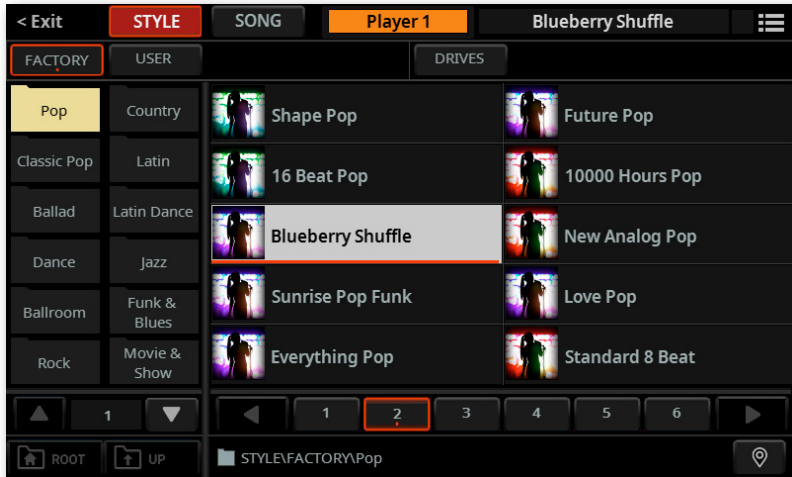

2 Touch a **folder** to see its content. **Ordinary folders** (like the ones in a PC) have a free organization. **KST folders** have the same fixed structure as the **User** area of the Internal memory.

In the following example, the “My Show Set.KST” folder has been selected. This type of folder contains the User data of a Pa5X. In this situation, all the User files contained in the KST folder are selected.



3 While in a **KST folder**, touch a **type of data** to see all the available banks. In the following example, the Style banks are shown. At this point, all the Style banks are selected.

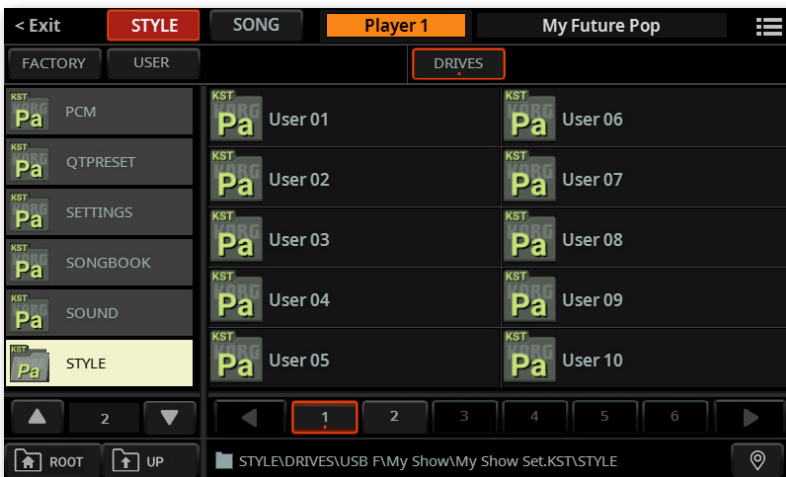

4 If you want to copy or move a **bank**, touch it to open it, and see the individual files it contains. Don't touch any file in the bank. In this situation, the full content

of the bank is selected. If you accidentally touch a file, keep the **SHIFT** button pressed and touch it again to deselect it.

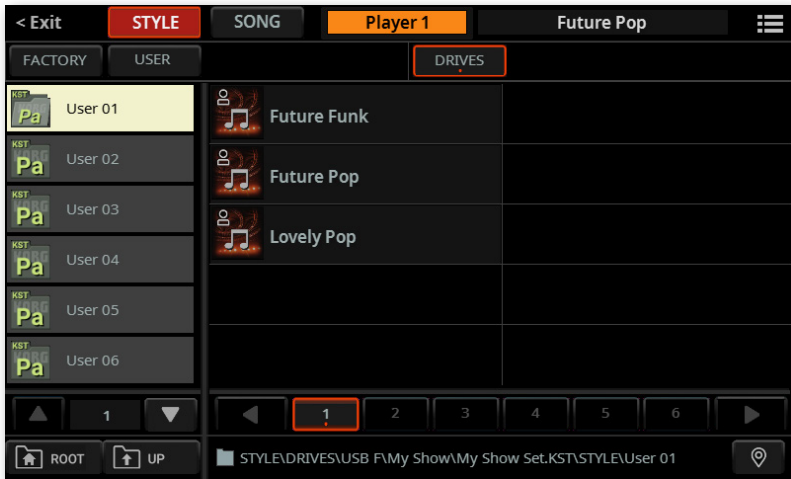

5 If you want to copy or move a **single file**, touch a bank to open it, and see the individual files it contains. When you see the file you want to copy or move, touch it to select it.



■ Choose the Copy or Cut command

> When the file or folder you want to copy or move is selected, choose the **Copy** or **Cut** command from the **page menu** (☰) to open the **Copy** or **Cut** dialog.

WARNING: Please note that, at the end of the **Cut** operation, the original data will be deleted from the original position.

■ Choose a destination

Once the source data has been selected, you can choose a destination.

1 Browse through the folders.

2 If you are pasting into a rigidly structured bank (for example, a Sound, a Mic or Guitar Preset, a MIDI Preset...) choose one of the available empty locations, shown as three hyphens ('---').

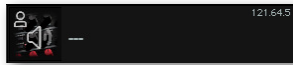

3 When you are in the drive or folder where you want to copy or move the data, or have selected the empty location, choose the **Paste** command from the **page menu** (☰).

The files you are copying or moving will be merged with the ones already existing in the target position. Only files with the same name will be replaced (after confirmation).

Copying and moving from the File pages

While in the **File** pages, you can copy or move data of any type. You have limited access to the **User** area of the internal memory and to **KST folders**, where you can't cut or paste data. This is to preserve the data structure integrity.

In these pages you can't copy or move elements that are organized in a rigid structure, like the Sounds, Mic and Guitar Presets, or MIDI Presets.

■ Choose the data to be copied

- 1 If you are copying from or to an external device, connect the device to one of the **USB HOST** ports.
- 2 Press the **FILE** button to see the main **File** page.

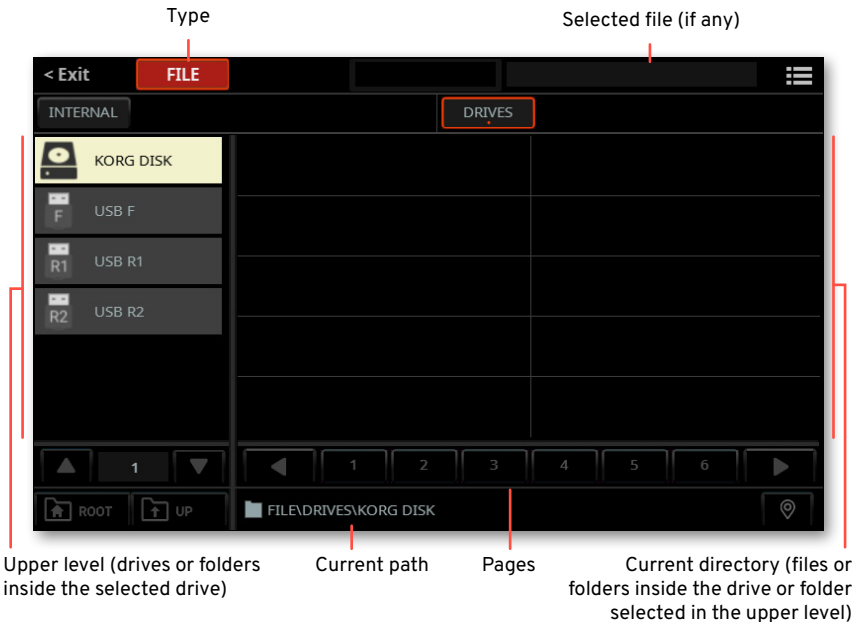

- 3 Touch the **Internal** button to see the **User** area in the internal memory, touch the **Drives** button to see the drives. You have no access to the **Factory** area. The image above shows a typical display of this page.

4 Browse through the folders. Touch a **folder** to open it. Touch the **Up** button to close the current folder and see the upper directory. Touch the **Root** button to return to the main directory of the drives.

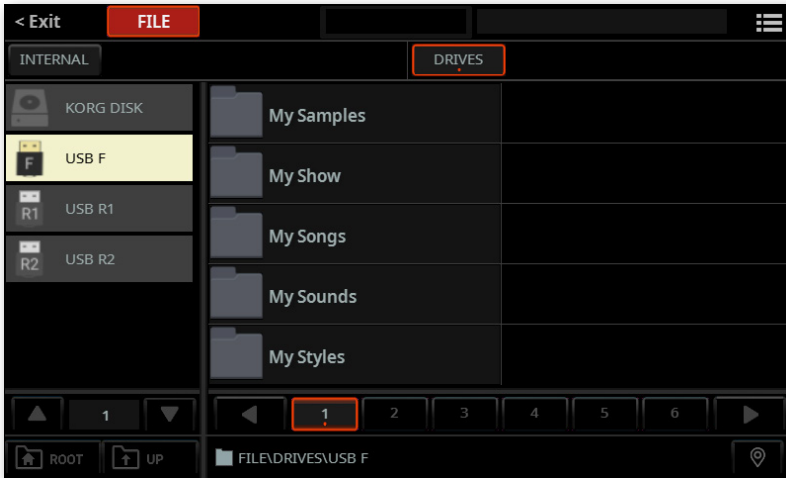

5 Touch a **folder** to see its content. **Ordinary folders** (like the ones in a PC) have a free organization. **KST folders** have the same fixed structure as the **User** area of the Internal memory. You can browse them as seen in the previous section (devoted to copying and moving from the **Select** windows).

6 If you want to copy or move a **folder**, touch it to open it, and see the individual files it contains. Don't touch any file in the folder. In this situation, the full content of the folder is selected. If you accidentally touch a file, keep the **SHIFT** button pressed and touch it again to deselect it.



7 If you want to copy or move a **single file**, touch a folder to open it, and see the individual files it contains. When you see the file you want to copy or move, touch it to select it.

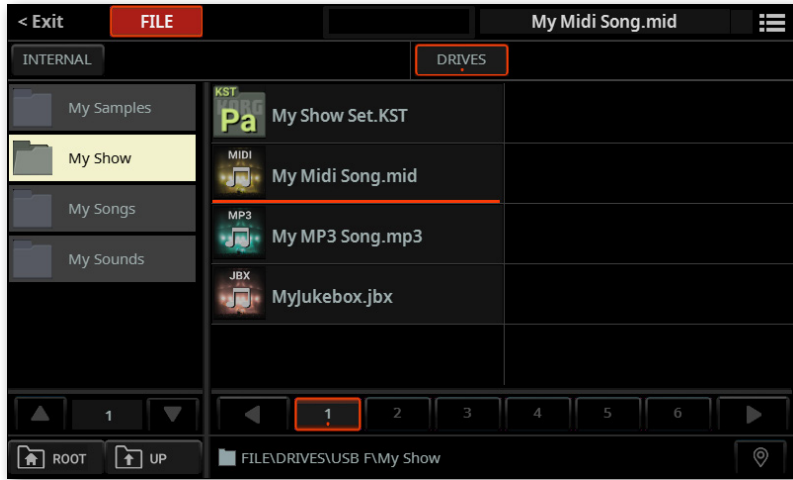

■ Choose the Copy or Cut command

➤ When the file or folder you want to copy or move is selected, choose the **Copy** or **Cut** command from the **page menu** (☰) to open the **Copy** or **Cut** dialog.

WARNING: Please note that at the end of the **Cut** operation, the original data will be deleted from the original position.

■ Choose a destination

Once the source data has been selected, you can choose a destination.

- 1** Browse through the folders.
- 2** When you are in the drive or folder where you want to copy or move the data, choose the **Paste** command from the **page menu** (☰).

The files you are copying or moving will be merged with the ones already existing in the target position. Only files with the same name will be replaced (after confirmation).

Overwriting existing files or folders

When pasting, a file or folder with the same name of the file or folder being pasted might be found in the target position. In this case, Pa5X will ask you if you want to overwrite it.

When a duplicate file or folder is met, the following dialog will appear:

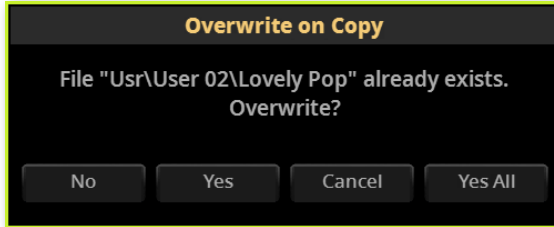

Overwrite	Meaning
No	The file or folder is not overwritten. The source file or folder is not pasted. The procedure will continue with the other files and folders.
Yes	The file or folder is overwritten. The procedure will continue with the other files and folders.
Yes (to) All	The file or folder is overwritten. Any following duplicate file or folders will be overwritten as well, without this dialog box appearing again. The procedure will continue with the other files and folders.
Cancel	The procedure is interrupted.

Renaming files and folders

You can rename files and folders, both in the **File** and the **Select** pages. Renaming folders allows, for example, to customize the name of the User banks. You can rename User data, but not Factory data.

- 1 If you are renaming data from an external device, connect the device to one of the **USB HOST** ports.
- 2 Go to one of the **File** or **Select** pages.
 - > Touch the **type of data** (Style, Keyboard Set...) of which you want to open the corresponding **Select** window. You will be able to rename the files and folder for that type of data.
 - > Press the **FILE** button to access the **File** pages. You will be able to rename ordinary files and folders.
- 3 Browse through the folders. Touch a **folder** to open it. Touch the **Up** button to close the current folder and see the upper directory. Touch the **Root** button to return to the main directory of the drives.
- 4 Select the **file** or **folder** you want to rename.
- 5 Choose the **Rename** command from the **page menu** (☰) to open the **Rename** dialog.

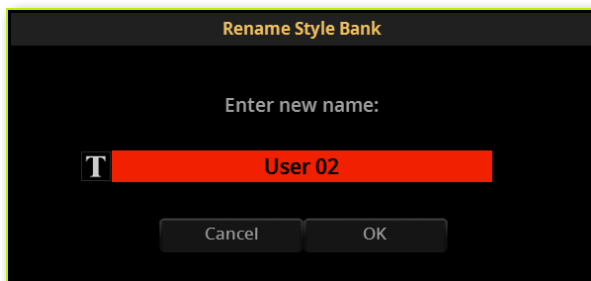

- 6 Touch the **Text Edit** (T) button to open the **virtual keyboard** and edit the name.

7 When done editing the name, confirm by touching the **OK** button under the virtual keyboard. Depending on the type of data, the banks may be reorganized by alphabetical order.

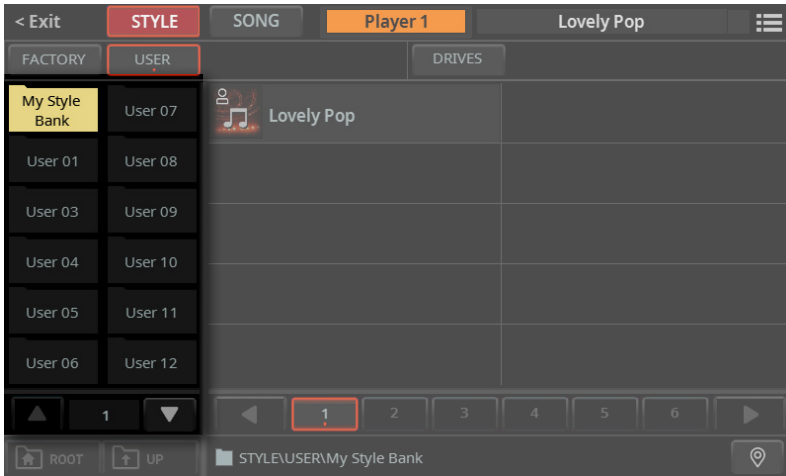

8 When back at the **Rename** dialog, touch the **OK** button to confirm, or **Cancel** to stop the procedure.

Deleting files and folders

You can delete files and folders, both in the **File** and the **Select** pages. You can delete from both the internal memory and the drives. You can delete User data, but not Factory data.

- 1 If you are deleting data from an external device, connect the device to one of the **USB HOST** ports.
- 2 Go to one of the **File** or **Select** pages.
 - > Touch the **type of data** (Style, Keyboard Set...) you want to open the corresponding **Select** window for. You will be able to rename the files and folder for that type of data.
 - > Press the **FILE** button to access the **File** pages. You will be able to delete ordinary files and folders.
- 3 Browse through the folders. Touch a **folder** to open it. Touch the **Up** button to close the current folder and see the upper directory. Touch the **Root** button to return to the main directory of the drives.
- 4 Select the file(s) or folder(s) you want to delete. Keep the **SHIFT** button pressed to select multiple elements.
- 5 Choose the **Delete** command from the **page menu** (☰) to open the **Delete** dialog.

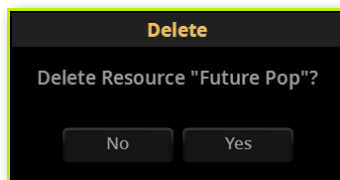

- 6 Touch the **OK** button to confirm, or **Cancel** to stop the procedure.

WARNING: If you confirm, any of the selected items will be deleted!

Creating new folders or banks

Folder and banks are very similar, but there is a subtle difference between them.

- > **Folders** are generic containers, that can contain any type of file and folder. They are exactly like the folders in a computer's file system.
- > **Banks** are specialized containers, organizing Pa5X proprietary data (like Styles or Pads) into the internal memory and into reserved KST folders.

■ Create a new folder or bank

- 1 If you are creating a new folder or bank into an external device, connect the device to one of the **USB HOST** ports.
- 2 Go to one of the **File** or **Select** pages.
 - > Touch the **type of data** (Style, Keyboard Set...) you want to open the corresponding **Select** window for. You will be able to create new banks for that type of data.
 - > Press the **FILE** button to access the **File** pages. You will be able to create new ordinary folders.
- 3 Browse through the folders. Touch a **folder** to open it. Touch the **Up** button to close the current folder and see the upper directory. Touch the **Root** button to return to the main directory of the drives.
- 4 When the containing folder is open, choose the **New Folder** or **New Bank** command from the **page menu** (☰) to open the **New Folder** or **New Bank** dialog. A new folder will be created inside the current directory. A new bank will be created next to the current directory.

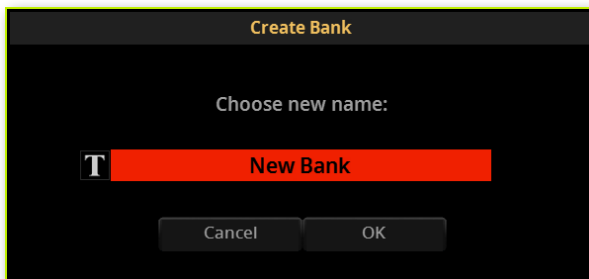

- 5 Touch the **Text Edit** () button to open the **virtual keyboard** and edit the name.
- 6 When done editing the name, confirm by touching the **OK** button under the virtual keyboard. Depending on the type of data, the banks may be reorganized by alphabetical order.
- 7 When back at the **New Folder** or **New Bank** dialog, touch the **OK** button to confirm, or **Cancel** to stop the procedure.

Formatting a drive

The Format function lets you initialize a device. Pa5X uses a PC-compliant device format (FAT32).

- 1 Touch the drive you want to format.
- 2 Choose the Format command from the **page menu** (☰).

WARNING: Formatting a storage device deletes all the data it contains!

■ Choose the device to be formatted

- 1 If you are formatting an external device, connect the device to one of the **USB HOST** ports.
- 2 Press the **FILE** button to see the main **File** page.
- 3 Touch the **Drive** button to see the connected drives.

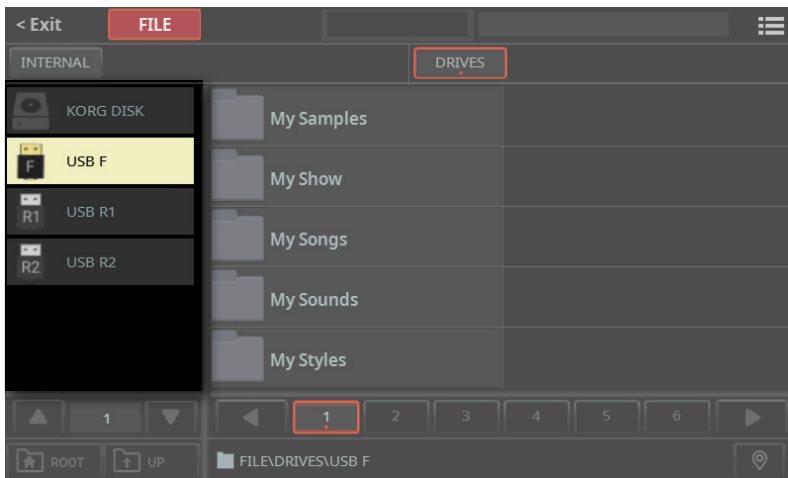

- 4 In the left column, touch the **drive** to be formatted.

5 Choose the **Format** command from the **page menu** (☰) to open the **Format** dialog.



6 Touch the **Text Edit** (T) button to open the **virtual keyboard** and edit the name. When done editing the name, confirm by touching the **OK** button under the virtual keyboard.

Since it is a reserved name, you cannot rename the label (name) of the internal volume ('KORG DISK'). When formatting the internal drive, the label cannot be edited.

Also, if you try to rename the internal volume when Pa5X is connected to a PC through the USB port, the original name will be automatically restored.

Please note that renaming a device, containing MIDI Songs or MP3 Songs used in the SongBook, will break the links to the files. We suggest to give the device the same name it had before formatting.

7 Touch the **OK** button to start formatting, or the **Cancel** button to stop the procedure. If you confirm, a warning appears.

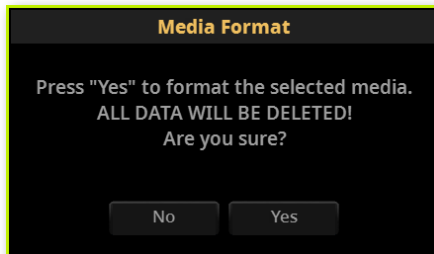

8 Touch **Yes** to confirm, or **No** to exit.

Getting information on drives and files

Getting information on the selected items

You can get information on the select file(s) or folder(s), including size, path, modification date and protection status.

- 1 While in any of the **File** pages, select one or more **items**. Keep the **SHIFT** button pressed to select multiple elements.
- 2 Choose the **Object(s) Info** command from the **page menu** (☰).

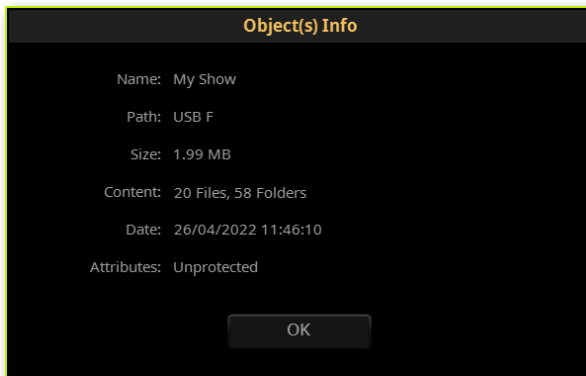

- 3 Touch the **OK** button to close the dialog.

Getting information on the selected device

You can get information on the selected drive.

- 1 While in any of the **File** pages, touch the **Drives** button to see the drives.
- 2 Touch one of the connected **drives** in the left side of the display. If the drives are not shown, touch the **Root** button to see them.
- 3 Choose the **Device Info** command from the **page menu** (☰).

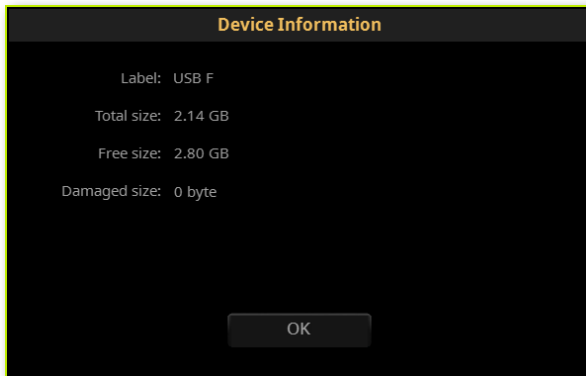

Pa5X will check the health status of the connected devices, and report if there is damaged data on it. If there is, please use a personal computer to run a disk scanning utility and try to repair it.

- 4 Touch the **OK** button to close the dialog.

Getting information on the operating system

You can get information on the current operating system version. Please check our web site to see if a new version is available.

1 While in any of the **File** pages, choose the **System Info** command from the **page menu** (☰).

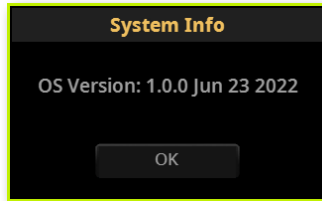

2 Touch the **OK** button to close the dialog.

Protecting storage devices and files

Protecting the files in the internal drive

You can protect the files in the internal drive ('KORG DISK') from saving. This can be useful to be sure you have all the necessary data ready during a show.

1 Go to the **Settings > Menu > Preferences > Files** page.

As an alternative, keep the **SHIFT** button pressed and press the **FILES** button to open the **Preferences > Files** page.

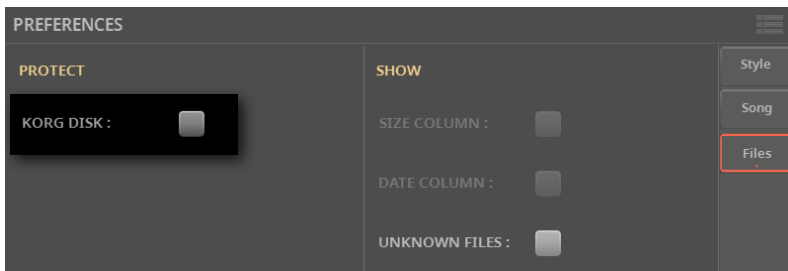

2 Select the **Protect > KORG DISK** checkbox to protect the files from writing.

3 Deselect it to allow writing the files again.

Protecting any file from writing

■ Protect the files or folders

- 1 While in any of the **File** pages, select one or more **items** in one of the external drives and choose the **Protect** command from the **page menu** (☰).
- 2 When the warning message appears, touch **Yes** to confirm (or **No** to cancel).

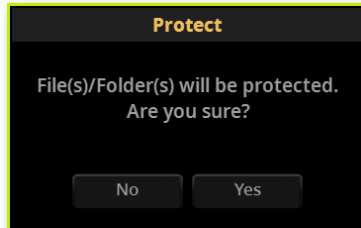

Choosing this command will protect the selected file(s). If you selected a folder, all the files it contains will be protected from saving or erasing. The lock icon will appear next to the file name(s).



■ Unprotect the files or folders

- 1 While in any of the **File** pages, select one or more **items** in one of the external drives and choose the **Unprotect** command from the **page menu** (☰).
- 2 When the warning message appears, touch **Yes** to confirm (or **No** to cancel).

Changing the file display preferences

Showing files of unknown type

To make file lists cleaner and easier to browse through, files that cannot be used can be hidden when using the File operations.

1 Go to the **Settings > Menu > Preferences > Files** page.

As an alternative, keep the **SHIFT** button pressed and press the **FILES** button to open the **Preferences > Files** page.

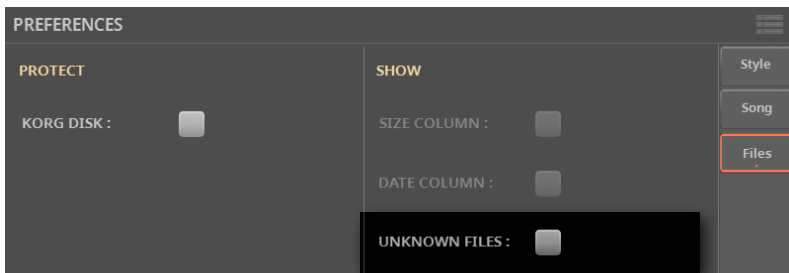

2 Select the **Unknown Files** checkbox to show files of unknown type.

Backing up and restoring the musical resources

Backing-up the data from the internal memory

We recommend you frequently make a backup copy of all the data in the internal memory. This will save your work in case of errors while saving, or any type of accidental data loss.

- **Choose the source and target device and folder**

1 If you are backing-up to an external device, connect the device to one of the **USB HOST** ports.

2 Press the **FILE** button to see the main **File** page.

3 Touch the **Internal** button, to see the content of the **User** area of the internal memory. In this situation, all the User files contained in the internal memory are selected.

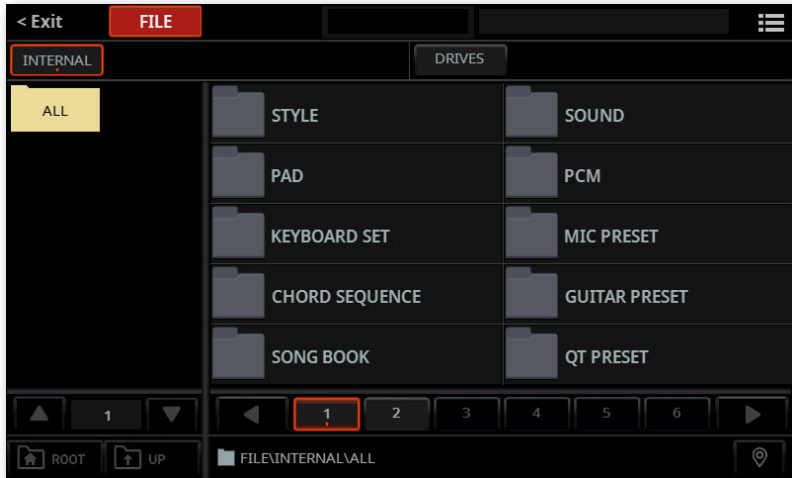

4 While the **All** folder is selected, choose the **Save** command from the **page menu** (☰) to open the **Save** dialog.

5 If no target KST folder has been selected yet, a message will ask you to choose or create a new one. See the instructions regarding the **Save** operations, for details on how to choose or create a target KST folder.

HINT: We suggest you create a new KST folder. Save a backup into a new, blank KST folder, for ease of archiving and retrieving data.

Message warning no KST folder has been selected

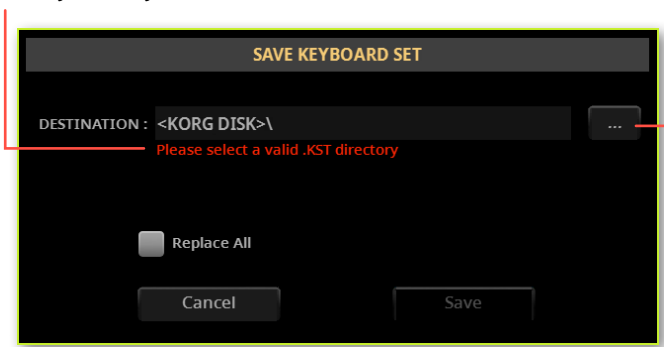

Touch to choose a target KST folder

6 Once the target KST folder has been selected, its name will appear in the **Save** dialog.

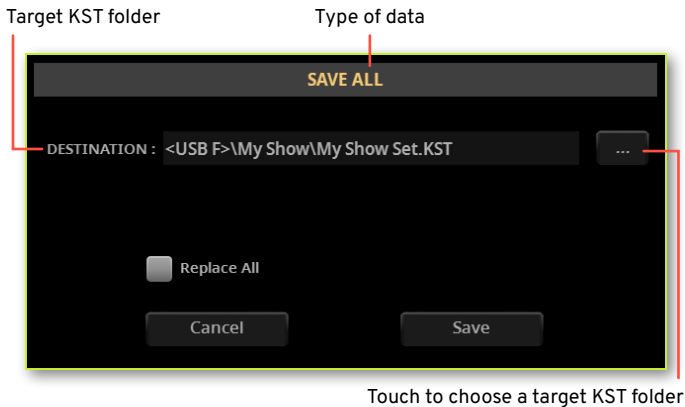

■ Merge or Replace the data at the destination

Choose whether you want to Merge or Replace the data.

- > If you **select** the **Replace All** checkbox, all the existing files of the selected type (Style, Keyboard Set...) in the target folder will be replaced by the ones you are saving. This can be useful if you want to replace all the data from an older backup.
- > If the **Replace All** checkbox will remain **unselected**, the files you are saving will be merged with the ones already existing in the target folder. Only files with the same name will be replaced. This can be useful to create an incremental backup over an existing one.

WARNING: Please note that replacing will delete all the data being replaced.

■ Save the data

- > Touch the **Save** button to confirm, or **Cancel** to stop the procedure. After confirming, any item you are overwriting will be deleted.

After saving, please don't touch anything in the saved KST folder, or the backup could be made unusable.

If you want, you can zip the KST folder, to be sure it will be preserved from any change.

Restoring the archived data

You can restore the data you previously backed up into a KST folder. If you want to only restore a bank, or individual files, please follow the **Load** instructions.

■ Choose the data to be loaded

You will select from a drive the data to be loaded into the internal memory.

- 1 If you are restoring from an external device, connect the device to one of the **USB HOST** ports.
- 2 Press the **FILE** button to see the main **File** page.

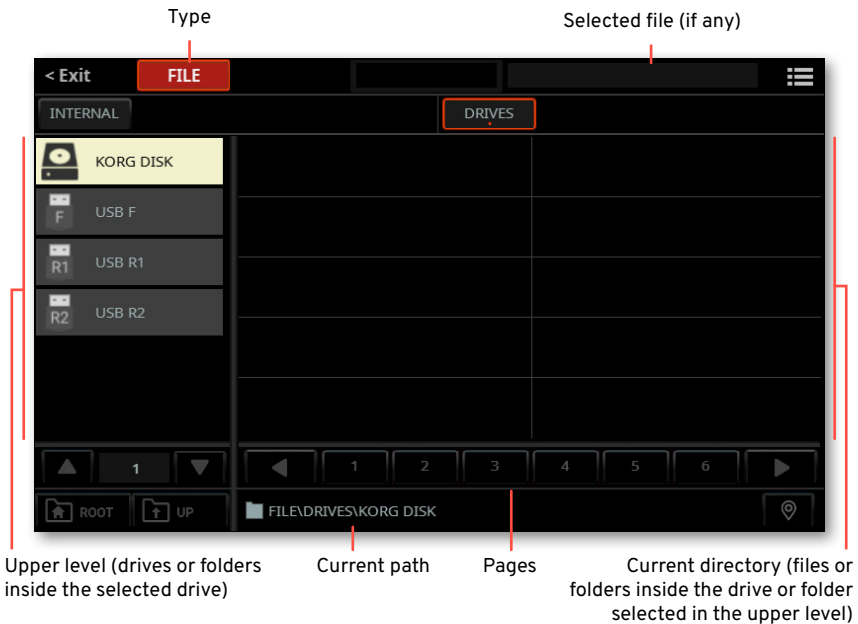

3 Touch the **Drives** button, and browse through the folders to find the **KST folder** where you saved your data. Touch a **folder** to open it. Touch the **Up** button to close the current folder and see the upper directory. Touch the **Root** button to return to the main directory of the drives.

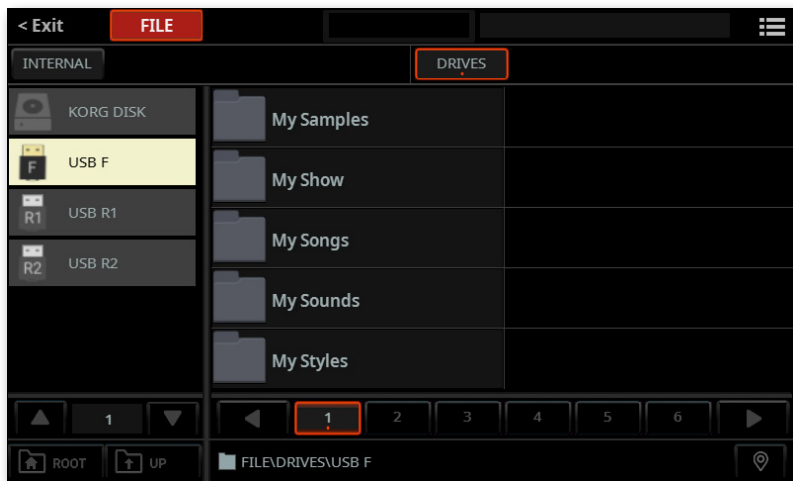

4 When you find it, touch the **KST folder** to select it.

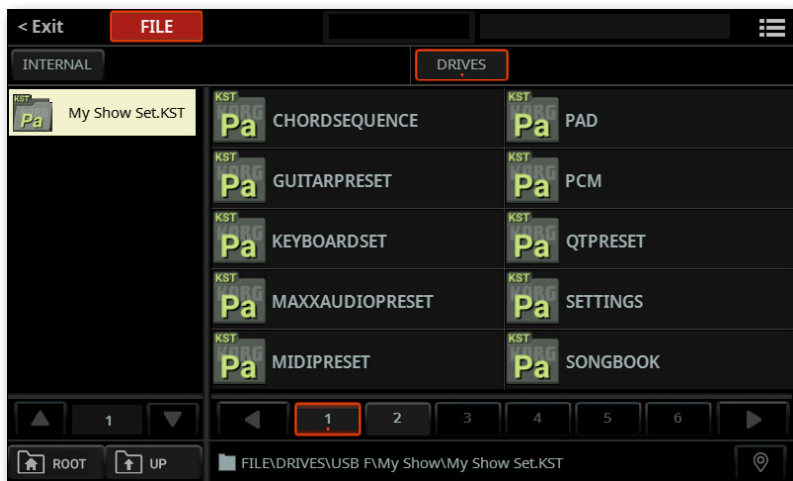

■ Load the data

1 When the KST folder you want to load is selected, choose the **Load** command from the **page menu** (☰) to open the **Load** dialog.

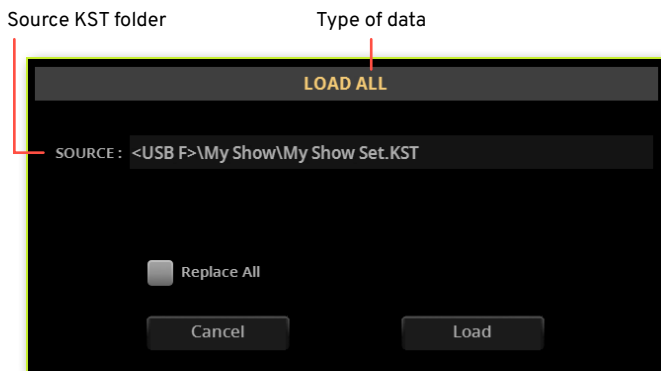

■ Merge or Replace the data at the destination

Choose whether you want to Merge or Replace the data.

- > If you **select** the **Replace All** checkbox, all the existing files of the selected type (Style, Keyboard Set...) in the internal memory will be replaced by the ones you are loading. This can be useful to fully restore a particular setup.
- > If the **Replace All** checkbox will remain **unselected**, the files you are loading will be merged with the ones already existing in the internal memory. Only files with the same name will be replaced. This is useful if you want to merge the data from different sessions.

WARNING: Please note that replacing will delete all the data being replaced.

2 Touch the **Load** button to confirm, or **Cancel** to stop the procedure. After confirming, any item you are overwriting will be deleted.

Restoring the original Factory data

You can restore your Pa5X to the same status it was when new, or when you did the latest operating system updated. The **Factory Restore** allows for deleting all the User data, or part of them.

- 1 Press the **FILE** button to access the **File** pages.
- 2 Press the **MENU** button to see the **edit menu** of the **File** mode.

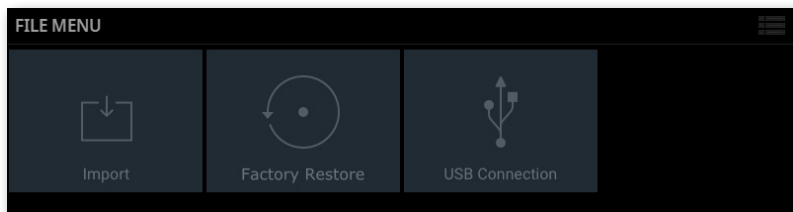

- 3 Touch the **Factory Restore** button to access the **Factory Restore** page.

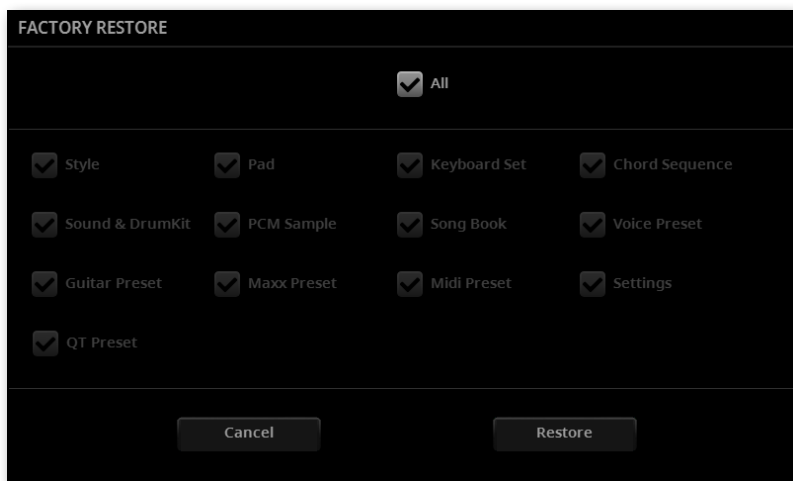

- 4 Choose if you want to restore all the User data, or just some of them.
 - > Leave the **All** checkbox selected if you want all the User data to be restored to the original status.

- > Deselect the **All** checkbox, and select only the desired data, if you want to only restore some types of data.

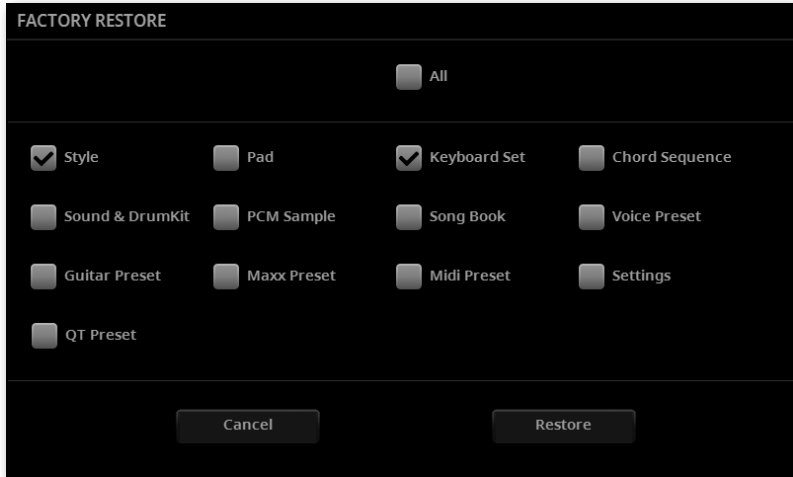

- 5 Touch the **Restore** button, then confirm.

WARNING: This command will delete from the internal memory all the selected types of User data. Be sure to have a copy of the data you want to preserve.

- 6 When done, a message will appear, confirming the User area in the internal memory has been restored.

Accessing the internal drives from a personal computer

In order to exchange files, you can access one of the internal drives of Pa5X from a personal computer. You don't need any dedicated driver to connect Pa5X and the personal computer.

■ Connect Pa5X to the personal computer

> Use a standard USB cable to connect the **USB DEVICE** port of Pa5X to an USB port of the personal computer.

■ Enable USB communication

1 Go to the **File > Menu > USB Connection** page, and use the **Device** menu to choose the internal drive to be shared.

2 Touch the **Enable** button to start sharing. The icon of the Pa5X's internal drive will appear in your personal computer.

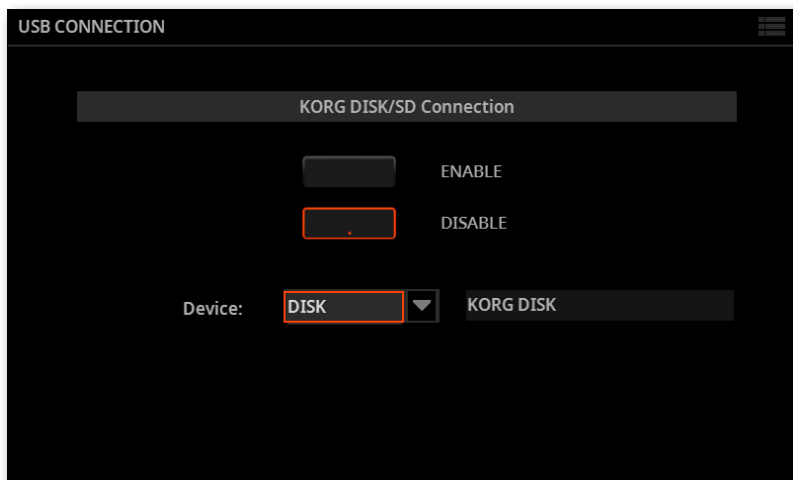

While USB file transfer is enabled, you cannot access other functions in Pa5X. MIDI Over USB is also disabled.

After starting the USB connection, accessing the internal drive from the computer may take some time, depending on the size of the internal drive and the amount of data it contains.

Do not try to change the label (name) of its internal drive when Pa5X is connected to a personal computer. If you try to do it, the original name is automatically restored. This name is reserved and can't be changed.

Also, do not modify the structure of the KST folders, or you will no longer be able to use them on Pa5X. Only use the USB connection for data exchange purpose, or to modify ordinary folders.

■ Disable USB communication

1 When finished transferring the files, you can disconnect Pa5X from the personal computer.

> On a Windows PC, select the dedicated command by clicking on the USB device icon () with the right mouse button.

> On a Mac, select the USB device icon (), then select the **Eject** command or drag the drive icon to the eject icon in the Dock ().

2 In Pa5X, touch the **Disable** button to disable the **USB DEVICE** port for file transfer, and gain access to all the instrument's functions.

WARNING: Do not disconnect USB communication before the personal computer has really finished transferring files. Sometimes, the on-screen indicator tells the procedure has been completed BEFORE it has really finished. Disconnecting USB communication (or disconnecting the USB cable) before data transfer has been completed may cause data loss.

Care of the storage devices

Pa5X can save most of the data contained in memory to the internal drive, a microSD card installed in the dedicated slot, or to external devices (like hard drives or USB memory sticks) connected to the **USB HOST** ports. Here are some precautions when handling these devices.

Internal drive write protection

You can protect the internal drive from writing, by using the software protection found in the **Settings > Menu > Preferences > Files** page (**Protect > KORG DISK** checkbox).

Precautions

- > Do not remove a device or move the instrument while the device is operating.
- > In order to avoid losing data in case of damage, make a backup copy of the data contained in a device. You can backup your data to a personal computer, and from there to a backup unit. You can transfer data from the internal drives of Pa5X to a personal computer by using the USB DEVICE connection.
- > Do not leave an USB device connected to the USB ports while carrying the instrument, or it may be damaged.
- > Keep the memory devices or the instrument away from sources of magnetic fields, for example televisions, refrigerators, computers, monitors, speakers, cellular phones and transformers. Magnetic fields can alter the contents of the devices.
- > Do not keep memory devices in very hot or wet places, do not expose them to direct sunlight and do not store them without use in dusty or dirty places.
- > Do not place heavy objects on top of the devices.

RECORD/EDIT

27

Recording Audio

Recording MP3 Songs

Recording an MP3 Song

■ Prepare for recording

- > Either choose a **Style** or **Song**, if you want to record them in the new Song. You can choose either MIDI or MP3 Songs.
- > Choose a **Keyboard Set** to assign Sounds to the keyboard.
- > Choose a **Mic Preset** to add effects to your voice, and a **Guitar Preset** to add effects to the guitar.
- > If you want, set all the other performance parameters (Pads, Chord Sequence, Split, Chord Recognition...).

1 Press the **REC/EDIT** button to open the **Record/Edit Menu** dialog.

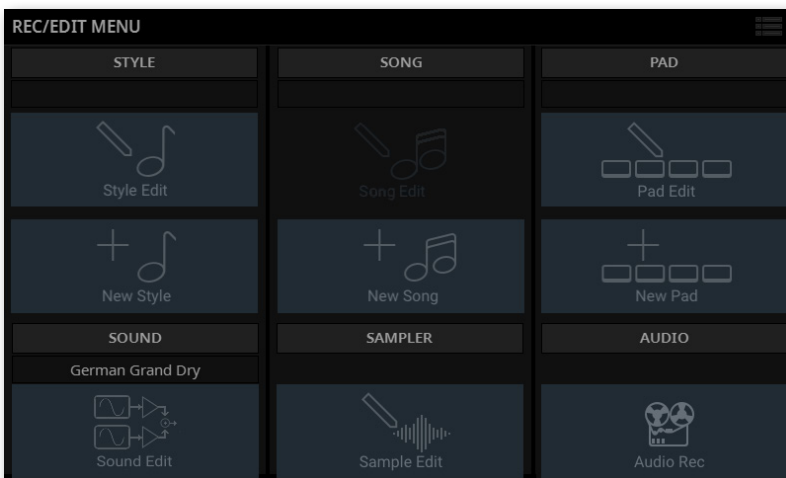

- 2 Choose the **Audio Rec** option to access the **MP3 Record** page.

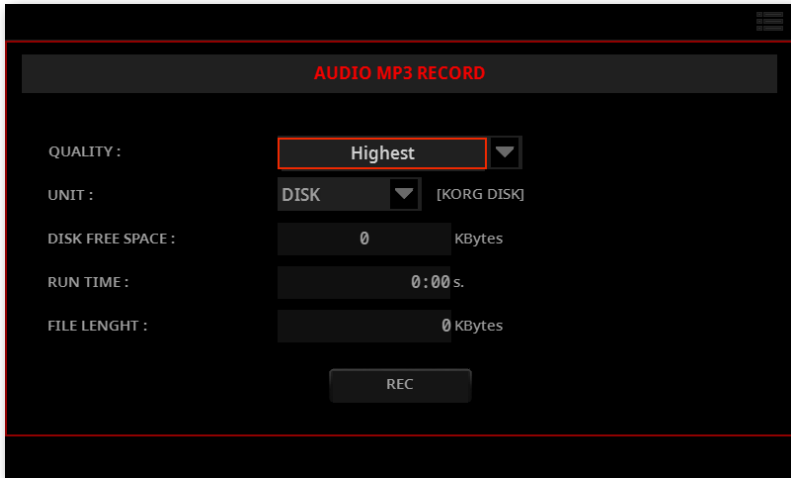

■ Set the recording parameters

- > Use the **Quality** pop-up menu to choose the preferred MP3 audio quality.

The higher the sound quality, the larger the MP3 file that will be generated.

Please note that MP3 files recorded with lower sampling rates might not sound as good as expected. With MP3 files there is always a trade-off between higher quality and smaller file size.

Quality	Meaning
Highest	256 kbps
High	192 kbps
Medium	128 kbps

- > Use the **Unit** pop-up menu to choose a drive where to temporary store the recorded MP3 file.

This is not the final destination of your file, since you will be able to choose a different location after recording. However, be sure there is enough space for the temporary file, by checking the **Disk Free Space** parameter. The current file size is always shown by the **File Length** parameter.

■ Record the MP3 Song

1 Touch the **REC** button in the display to start recording.

The **REC** button will change to **STOP**, and the **REC** indicator will start flashing in the top left corner of the display.

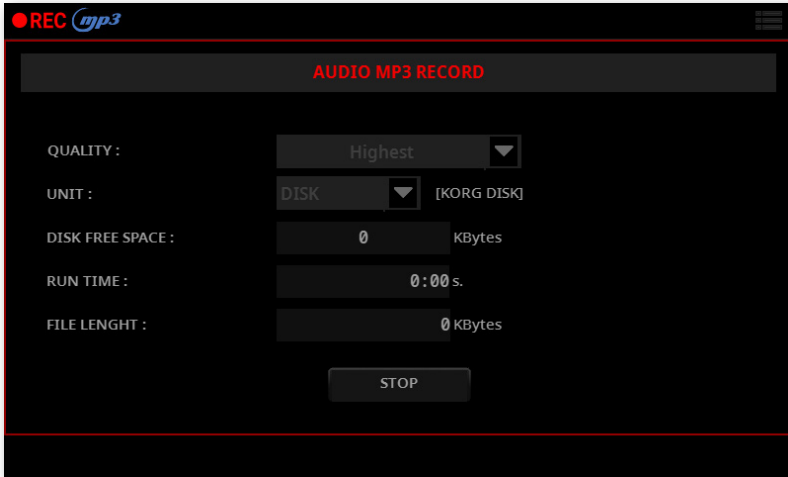

2 Start playing your song.

During recording, use the **MP3 Record** dialog to check the **Run Time**, **File Length** and the **Free Space** on the storage device.

■ Exit the MP3 Record dialog without stopping recording

> If you like, press the **EXIT** button to exit the **MP3 Record** dialog and navigate through the Style Play and Song Play pages, without stopping to record.

If you exit from the **MP3 Record** dialog while recording, a red **REC** indicator will continue flashing in the display.



> To access the **MP3 Record** dialog again, and see the file length or stop recording, press the **REC/EDIT** button again.

■ Stop recording

> Touch the **STOP** button in the display to stop recording.

What can you record into an MP3 Song?

Everything you sing in the microphone, play with the guitar or play on the keyboard; what is generated by the Styles and the MIDI or MP3 Songs performed by the Players; the events generated by the Pads effects – everything will be recorded.

Saving the MP3 Song

After having stopped recording, the MP3 Record dialog will allow you to choose a location for saving the MP3 file.

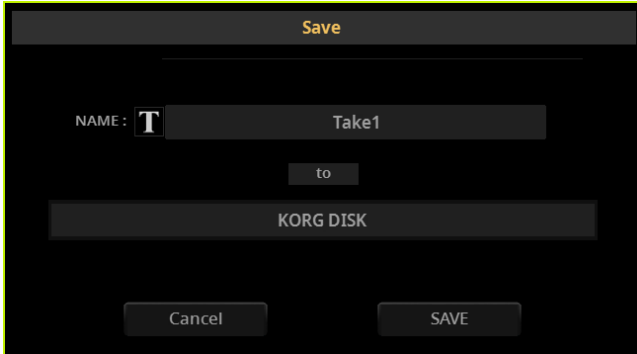

- 1 Touch the **Text Edit (T)** button to give the MP3 file a name.
- 2 Touch the **name of the disk** to select a **storage device** where to save the file.
- 3 Touch the **Save** button to save the MP3 file.

After saving, you can listen to the MP3 Song with the Players. The MP3 file can also be moved to a personal computer for listening or further editing.

Overdubbing MP3 Songs

MP3 Songs are compressed audio. Compression replaces the original audio stream with encoded audio, taking less space while preserving high sound quality. Overdubbing is the process of recording audio over existing audio.

When overdubbing an MP3 Song in MP3 Record mode, you recompress a compressed file, and artifacts will be amplified. If you transpose the MP3 Song, pitch-shifting artifacts will be added and further degrade the resulting audio.

It is suggested to compose using the internal Sounds and MIDI Songs. You can transpose and overdub MIDI Songs without any audio degradation. When done with your song, you can record it as an MP3 file.

28

Recording and editing the Songs

The Song Edit mode

Accessing the Song Edit mode

You can record and edit MIDI Songs in Song Edit mode. Pa5X includes a 16-track MIDI sequencer.

- 1 If you want to edit an existing **MIDI Song**, assign it to **Player 1**. Be sure this Player is selected.
- 2 Press the **REC/EDIT** button on the control panel to see the **Record/Edit** menu.

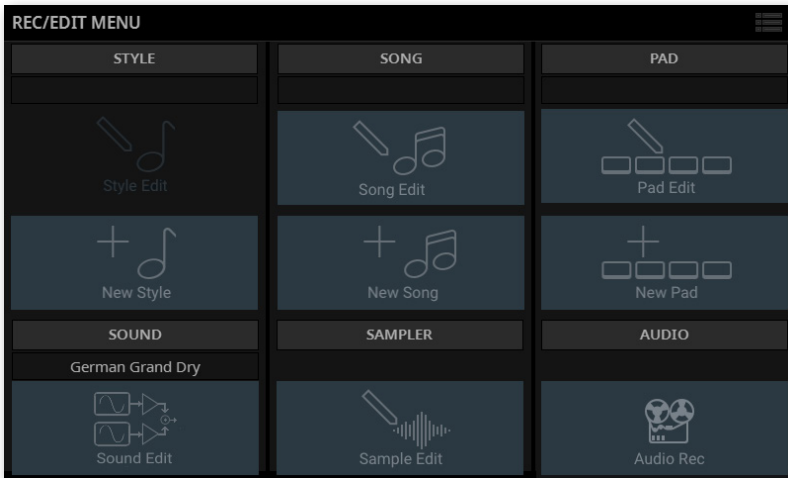

- 3 Touch the **Song Edit** button in the menu, and confirm if you agree to lose any unsaved changes. The **main page** of the **Song Edit** mode will appear.

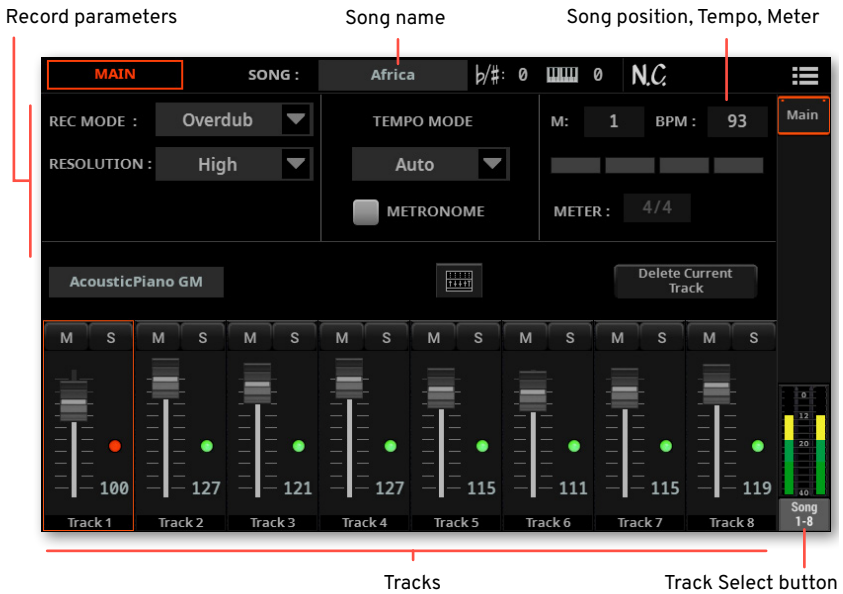

- 4 Press the **MENU** button on the control panel, and touch one of the buttons to choose the corresponding **edit section** of the **Song Edit** mode.

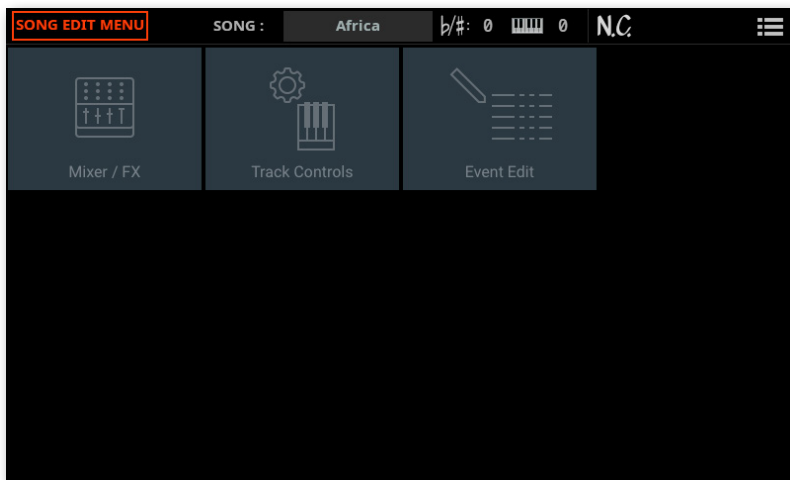

- 5 Press the **EXIT** button on the control panel to return to the **main page** of the **Song Edit** mode.

Listening to the Song

While in the **Song Edit** mode, you can use the **Player 1** controls to listen to the Song. However, please remember that a track is always selected for recording, so anything you'll play on the keyboard will be recorded, and may damage the Song.



You can also mute and solo each track, by using the dedicated **Mute** (**M**) and **Solo** (**S**) buttons.

To deactivate the Solo from all the tracks, you can also choose the **Disable Solo** command from the **page menu** (**☰**).

Saving the MIDI Song

When finished editing the Song parameters, choose the **Save Song** command from the **page menu** (**☰**) to save the Song. More details on saving Song at the end of this section.

Exiting the Song Edit mode

To exit from the **Song Edit** mode, press the **EXIT** or the **REC/EDIT** button again. In case there are unsaved data, a message will warn you.

Recording MIDI Songs

Preparing to record

Setting the Record parameters

While in the **Edit Song > Main** page, you can record a MIDI Song made of up to 16 MIDI tracks.

When you enter the Multitrack Sequencer mode, you could simply start recording. However, there are some additional settings that you might want to do.

■ Setting the recording mode

Recording can happen by overdubbing existing data, or overwriting them.

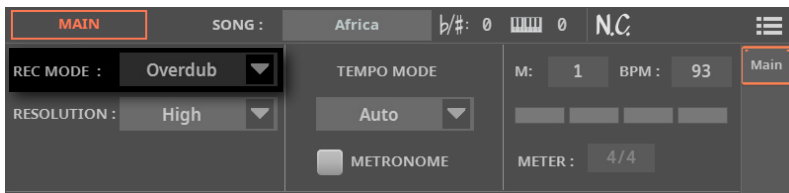

> Use the **Rec Mode** pop-up menu to choose the **Overdub** or **Overwrite** recording mode.

Recording Mode	Meaning
Overdub	The newly recorded events will be mixed to any existing events.
Overwrite	The newly recorded events will replace any existing events.

■ Setting the recording resolution

You can use automatic rhythm correction while recording.

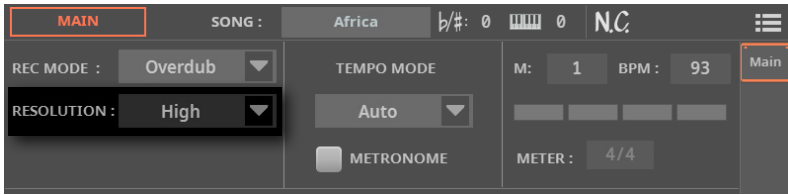

> Set the recording **Resolution**.

Resolution	Meaning
High	No quantization applied
 ♪ (1/32) ... ♪ (1/8)	Grid resolution, in musical values. For example, when you select 1/16, all notes are moved to the nearest 1/16 division. When you select 1/8, all notes are moved to the nearest 1/8 division. The 1/12 and 1/24 values are triplets.
	No quantization
	1/16
	1/8

■ Setting the Tempo mode and the metronome click

You can set the Tempo mode, and turn on the metronome click.



- > Use the **Tempo Mode** pop-up menu to choose the way Tempo events will be recorded.

Tempo Mode	Meaning
Manual	Manual reading. The latest manual Tempo setting (made using the TEMPO buttons) is considered the current Tempo value. No Tempo change events will be recorded. This is very useful when you want to record the Song at a much slower speed than the actual Tempo.
Auto	Auto reading. The Sequencer plays back all the recorded Tempo events. No Tempo change events are recorded.
Record	All Tempo changes made during recording will be recorded to the Master Track. Tempo is always recorded in overwrite mode (old data is replaced by the new data).

- > Select the **Metronome** checkbox to turn on the metronome click.

■ Setting the Tempo and Meter value

You can set the Tempo value and the starting Meter of the Song.

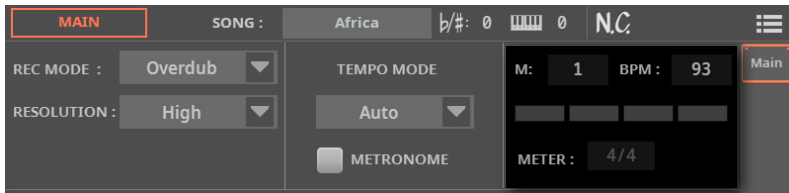

- > Use the **BPM (Beats Per Minute)** parameter to change the Tempo value.
- > Use the **Meter** parameter to change the Meter (or Time Signature). Please note that you can only change this value before recording anything.

Choosing the Sounds

■ Choose the Sounds from the Main page

You choose the Sounds directly from the **Song Edit > Main** page.

- 1 Touch the track whose Sound you want to change.
- 2 Touch the name of the corresponding Sound to open the **Sound Select** window.

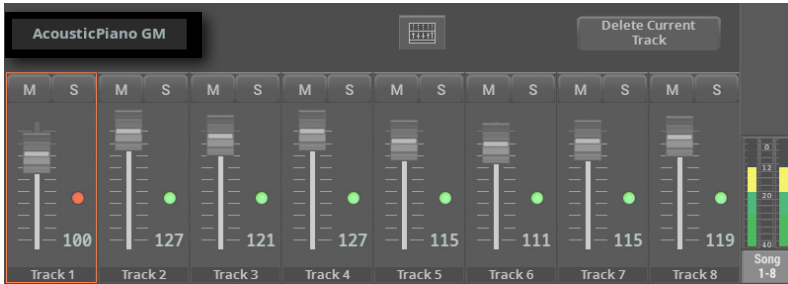

- 3 Choose a Sound, then press the **EXIT** button to return to the **Song Edit > Main** page.
- 4 Repeat the same procedure with all the other tracks.

■ Choose the Sounds from the Mixer page

You choose the Sounds going to the **Song Edit > Mixer** page.

- 1 Touch the **Mixer** () button to go to the **Song Edit > Mixer** page.

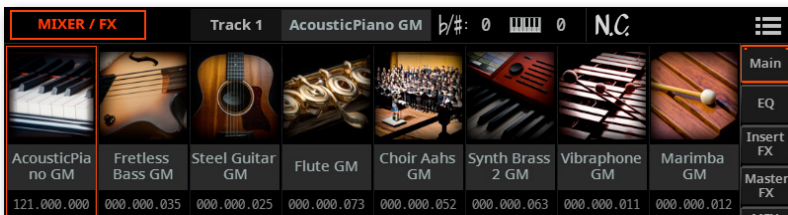

- 2 For each track, touch the name of the corresponding Sound to open the **Sound Select** window.
- 3 Choose a Sound, then press the **EXIT** button to return to the **Song Edit > Main** page.

Recording

First-take recording

■ Choose the starting position

You can choose the measure from which start recording.

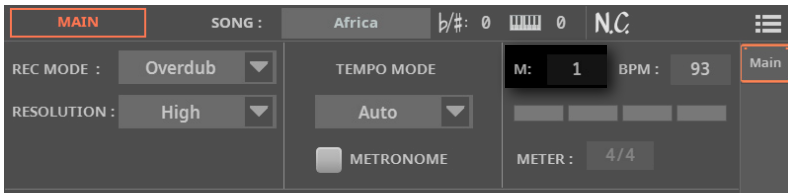

- > Use the **M(easure)** parameter to choose the measure from which to start recording.

Please note you can only select one of the existing measures in the Song. If the Song is still empty, you can only choose the first measure.

■ Select the track to record

- > While in the **Edit Song > Main** page, touch the track to be recorded. Its indicator will change to red.

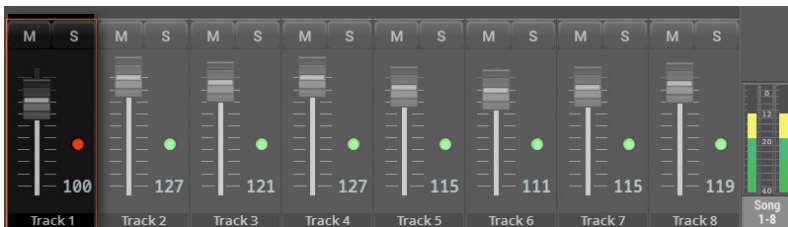

■ Start recording

1 Press the **PLAY/STOP** (▷□) button to start recording.

A **1-measure precount** will play before the recording actually begins. When it begins, record freely.

2 When finished, press the **PLAY/STOP** (▷□) button to stop recording.

3 Select a different track, and go on recording the whole Song, one track at a time.

Second-take recording

You may want to record additional events, or replace a previously recorded track. If so, repeat recording.

■ Prepare to record

1 While in the **Song Edit > Main** page, touch the track to be recorded.

2 Use the **M(easure)** parameter to choose the measure from which to start recording.

3 Use the **Rec Mode** pop-up menu to choose the **Overdub** or **Overwrite** recording mode. Choose **Overdub** if you want to add events to the same track, **Overwrite** if you want to replace recorded data.

Overdub is useful, for example, when recording different percussive instruments in subsequent cycles.

■ Start recording

1 Press the **PLAY/STOP** (▷□) button to start recording.

A **1-measure precount** will play before the recording actually begins. When it begins, record freely.

2 When finished, press the **PLAY/STOP** (▷□) button to stop recording.

Saving the Song

When done recording, you should save the Song.

- 1 Choose the Save Song command from the **page menu** () to open the **Save Song** dialog.
- 2 Choose a location where to save the Song.

More details are in [Saving the MIDI Songs](#) on page 725.

The Mixer and the Effects

You can edit the Mixer and Effect parameters by going to the **Song Record > Menu > Mixer/FX** pages.

You can also jump to this page by touching the **Mixer** () button in the **Song Edit > Main** page.



The editable parameters are exactly the same explained for the **Home** mode. See [The Mixer](#) on page 337.

The Track parameters

You can edit the Song Track parameters by going to the **Song Record > Menu > Track Controls** pages.

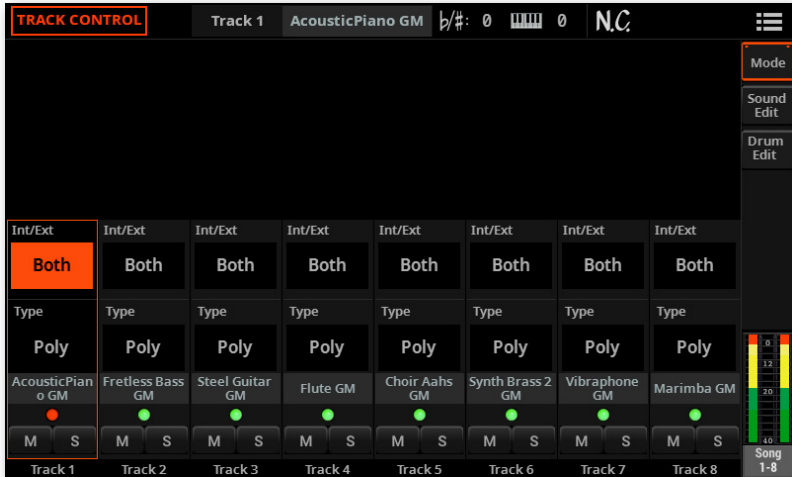

The editable parameters are exactly the same explained for the Home mode. See [Recording and editing the Songs](#) on page 707.

Editing the MIDI events

The Event Edit page

The Event Edit is the page where you can edit each single MIDI event of the selected track. You can, for example, replace a note with a different one, or change its playing strength (that is, velocity value).

You can edit the MIDI events by going to the **Song Record > Menu > Event Edit** pages.

a. Choose the track to edit

b. Jump to the event at the current position

c. Edit the events

Position	Type	Value1	Value2	Length
M:048.02.192	Note	B3	110	D:000.00.070
M:048.02.288	Note	C#4	110	D:000.01.310
M:048.03.096	Control	1	15	
M:049.01.320	Control	1	0	
M:050.01.192	Note	F#4	111	D:000.00.052
M:050.01.288	Note	F#4	111	D:000.00.166
M:050.02.096	Note	F#4	110	D:000.00.094

The Event Edit procedure

Here is the general procedure to follow for the event editing.

■ Filtering the events shown

> Go to the **Song Edit > Menu > Event Edit > Filter** page to select the events to hide.

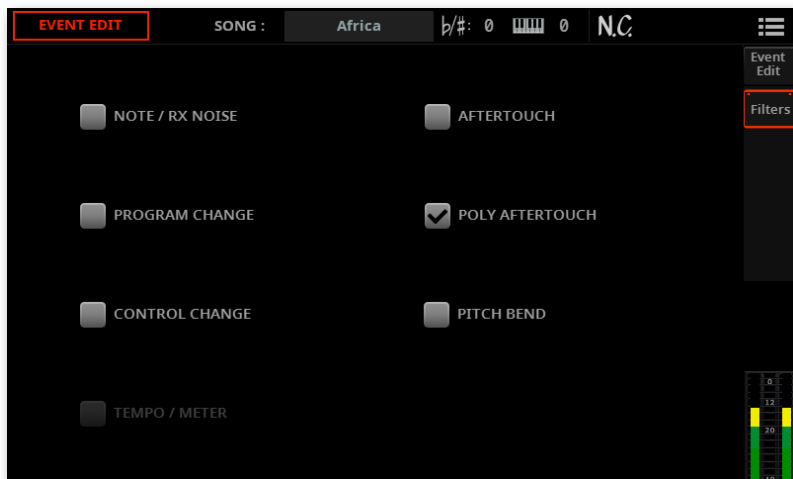

Filter	Meaning
Note/RX Noise	Notes and RX Noise events
Program Change	Program Change events
Control Change	Control Change events
Tempo/Meter	Tempo and Meter (time signature)
Aftertouch	Mono (Channel) Aftertouch events
Poly Aftertouch	Polyphonic Aftertouch events
Pitch Bend	Pitch Bend events

■ Edit the events

1 Go back to the **Song Edit > Event Edit > Event Edit** page.

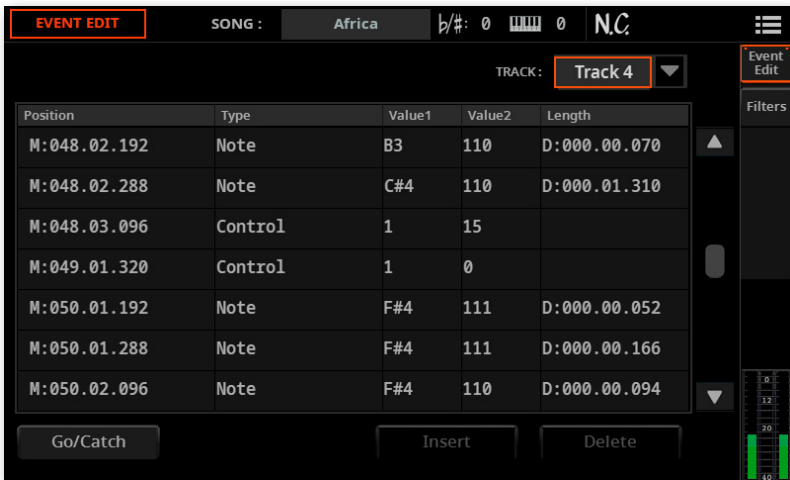

2 Use the **Track** pop-up menu to select the track to edit. When this parameter is selected, you can use the **DIAL** or **UP/DOWN** buttons to quickly explore the tracks.

The list of events contained in the selected track will appear in the display. Some events at the beginning of the track, as well as the 'End Of Track' event (marking its ending point) cannot be edited, and appear dimmed.

The **Tempo** track contains the initial Tempo, Meter and Key Signature events.

The **Master** track contains Volume and Tuning events.

3 Scroll through the various events by using the vertical scrollbar.

4 Touch the event to be edited, and edit it.

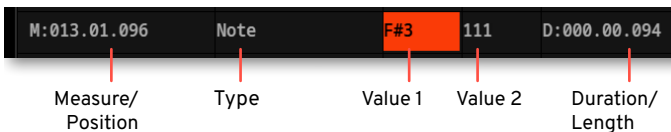

> Select the **M (Measure)**, and use the **DIAL** or **UP/DOWN** buttons to change event's position.

> Select the **Type** parameter, and use the the **DIAL** or **UP/DOWN** buttons to change the event type.

- > Select the **Value 1** and **Value 2** parameters, and use the **DIAL** or **UP/DOWN** buttons to edit them. In case of numeric values, you can also touch them twice to open the numeric keypad.

Event Type	Value 1	Value 2
Ordinary tracks (1-16)		
Note	Note name	Velocity
RX Noise	Note name	Velocity
Program	Program Change number	–
Control	Control Change number	Control Change value
Pitch Bend	Bending value	–
After Touch	Mono (Channel) Aftertouch value	–
Poly After Touch	Note to which the Aftertouch is applied	Poly Aftertouch value
Tempo track		
Tempo	Tempo change	–
Meter	Meter (time signature) change ^(a)	–
KeySign	Key Signature ^(b)	–
Master track		
Volume	Master Volume value	–
Scale	One of the available preset Scales	Root note for the selected Scale
User Scale	Altered note	Note alteration ^(c)
Quarter Tone	Altered note	Note alteration (0, 50) ^(c)
Quarter Tone Clear	Reset of all Quarter Tone (QT) changes	–

(a). Meter changes can't be edited or inserted separately from a measure. To insert a Meter change, use the Insert function in the Edit section and insert a series of measures with the new meter. Existing data can then be copied or entered to these measures

(b). This is the key signature shown in the Score. If this event is missing, the Score will be shown as if it was in the key of C Major.

(c). To edit User Scale and Quarter Tone settings, select the first value, then select the scale's degree to edit. Edit the second value to change the tuning of the selected note of the scale.

- > If a **Note** event is selected, select the **D (Duration/Length)** parameter, and use the **DIAL** or **UP/DOWN** buttons to change the event's length.

■ Jump to a different measure

1 Touch the **Go/Catch** button to go to a different measure. The Go To Measure dialog will appear:

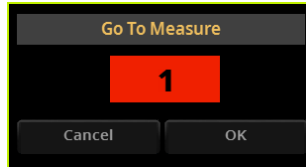

2 Enter a target measure and touch **OK** to confirm. The first event available in the target measure will be selected.

■ Insert events

- 1 Touch an event at the position where you want to insert a new event.
- 2 Touch the **Insert** button to insert an event at the current position. A Note event with default values will be inserted.
- 3 Edit the event type and values as needed.

■ Delete events

- > Select an event, then touch the **Delete** button to delete it.

■ Edit other tracks

- > When editing is complete, select a different track to edit.

■ Exit Event Edit

- > When finished editing the Song, press the **EXIT** button to go back to the **Song Edit > Main** page. As an alternative, you can press the **MENU** button to jump to any other **Edit Song** page.

Saving the MIDI Songs

Save the Song after recording or editing. If it is not saved, changes will be lost when exiting the Edit Song mode.

- 1 While in **Song Edit** mode, choose the **Save Song** command from the **page menu** (☰) to open the **Save Song** dialog.

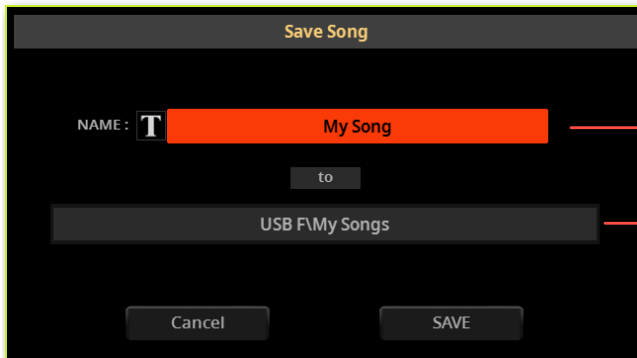

Song name

Touch to open the Select window and choose a target path

■ Save over the same Song

- > If you want to overwrite the current Song, just touch the **Save** button.

■ Rename the Song

While in the **Save Song** dialog, you may change the **name** of the Song.

- 1 Touch the **Text Edit** (T) button to open the **virtual keyboard** and edit the name.
- 2 When done editing the name, confirm by touching the **OK** button under the virtual keyboard.

■ Save to a different place

1 If you want to save to a different folder, touch the **To (target path)** button in the **Save Song** dialog, and open the **Save To** window.

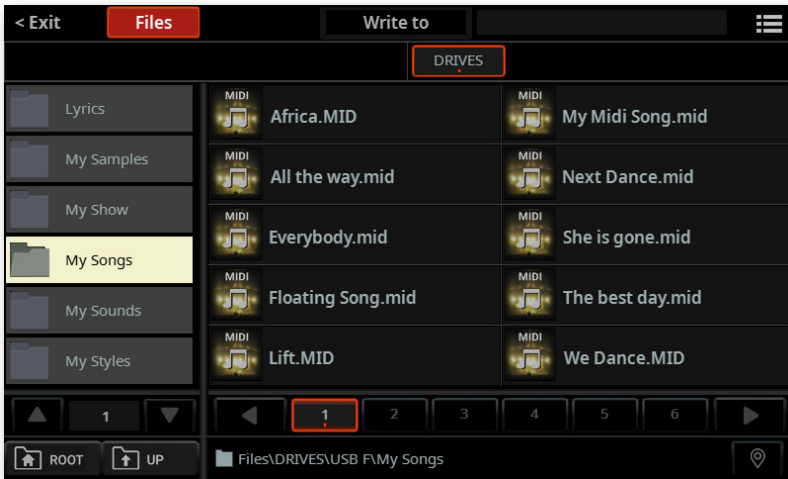

2 Browse through the folders, and choose a directory where to save the Song.

3 To save a new file, don't touch any of the Songs in the folder. On the contrary, if you want to overwrite one of the existing elements, touch it.

4 Press the **EXIT** button to close the **Save To** window and confirm your selection.

5 When back at the **Save Song** dialog, confirm the Save operation by touching the **Save** button.

A Standard MIDI File will be created in the target storage device. The file will have a .mid extension.

A setup measure, containing various Song initialization parameters, will be inserted at the beginning of the Song.

29

Recording and editing the Styles and Pads

Overview on the Style and Pads

Styles and Pads are music patterns automatically played by the Pa5X's internal arranger when you play a chord, to give you a live backing.

KORG supplies a huge amount of professionally crafted Styles and Pads with Pa5X. However, you are free to customize them, or to create totally new Styles and Pads on your own.

Styles and Pads share most of the same structure and recording/editing operations. Here is how they are made.

How Styles are made

Tracks and virtual musicians

A Style can be played by up to eight different virtual musicians. Each one is recorded in a track. They are Bass, Drum, Percussion, and five Accompaniment tracks (for strings, guitar, piano or other instruments).

Drum and Percussion tracks are not transposed. The Bass track is dedicated to the harmony root. You can freely choose the type of track (see [Editing the track type, trigger, tension](#) on page 779).

There may be a special Guitar track, that you can program with a dedicated editor (see [Recording a Guitar track](#) on page 760).

Each track can play music patterns organized into Style Elements (SE) and Chord Variations (CV).

Style Elements (SE)

A Style is made of a series of **Style Elements** (Intro, Variation, Fill, Ending...), each one corresponding to a section of a song. Variations can be used for Verses and Choruses, but also for Bridges and improvisational passages.

The Style Elements can be selected:

- > By using the corresponding **STYLE ELEMENT** buttons in the lower-left area of the control panel.



- > By touching the corresponding buttons in the **Style Elements** page in the display (accessed by pressing the **STYLE ELEMENT / MARKER** button in the upper-right area of the control panel).



- > Automatically selected by the **Auto Fill** function.



Chord Variations (CV)

Each **Style Element** includes the **Chord Variations**. Each Style or Pad track can have different Chord Variations. When you play in the chord recognition area, the arranger scans the keyboard and detects which chord you are playing. Then, depending on the selected Style Element, it chooses for each track the correct Chord Variation to be played for the recognized chord.

For example, if you play a C Major while Variations 1 is selected, the arranger will select the Chord Variation corresponding to the C Major chord for Variation 1. If you play the same chord while Fill 2 is select, the arranger will select the Chord Variation corresponding to the C Major chord for Fill 2.

Chord Variation Table

How each Chord Variation is associated to the recognized chord is decided by the **Chord Variation Table**. Each Style Element Track contains a freely programmable Chord Variation Table, that has the following structure:

Recognized Chord	Chord Variations (CV)	
	Variation 1-4	Intro 1-3, Fill 1-4, Break, Ending 1-3
Major		
6		
M7, M7 ^(b5)		
sus, sus2, M7sus		
m		
m6		
m7, m7 ^(b5) , m ^(M7)	CV1 - CV6	CV1 - CV2
7, 7 ^(b5) , 7sus4		
dim, dim7, dim ^(M7)		
#5		
7 ^(#5) , M7 ^(#5)		
omit 3, omit 5		

Chords

After deciding what Chord Variation to play (according to the Chord Variation Table), the arranger triggers the right pattern for each track. Since each pattern is written in a particular key (for example, C Major, G Major or E minor), the arranger transposes it according to the scanned chord. Notes in the pattern are carefully transposed, to make them work fine with all the recognized chords.

What happens when you play a chord

To summarize, when you play a chord in the chord recognition area, the arranger checks which Style Element is in use, then determines which Chord Variation should be used for the recognized chord in a track. Then, the patterns of that Chord Variation are transposed to match the recognized chord. And so on every time you play a chord.

What to record in a Style

Recording a Style means recording Chord Variations for each track, and doing so for each of the Style Elements.

You don't have to record all the available Chord Variations for all the tracks and Style Elements. Often you only need to record a single Chord Variation for each Style Element.

Exceptions are the Intro 1 and Ending 1, where we suggest to record a Major and minor Chord Variations.

The Style structure

To explain the Style structure, we can use a tree structure, as shown in the following diagram:

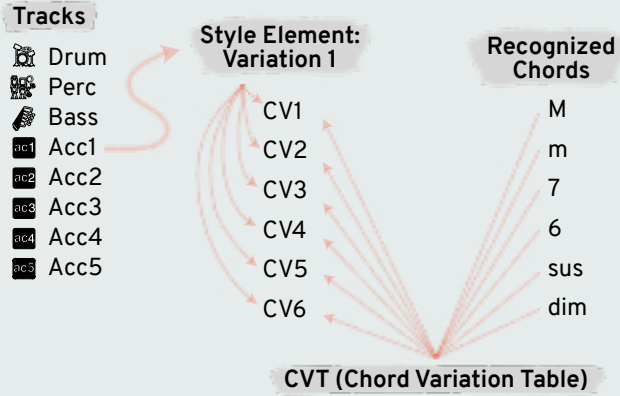

How Pads are made

The Pads

A Pad is basically a single-track, single Style Element Style. Most of what applies to Style recording also applies to Pad recording. There are two different categories of Pads: **Loop-type** (🔄) and **One Shot-type** (➔).

Pad type	Meaning
Loop	Cycling single-track patterns, that can be transposed by playing different chords on the keyboard – exactly as a Style track. They can also be Drum tracks, that will not be transposed.
One Shot	Single hits. While they are mostly used as non-transposing events, they can also be transposing notes or chords. Basically, they are single-note or single-chord patterns (see below).

Each Pad is made up of up to six smaller units, called Chord Variations (CV). Each Chord Variation is assigned to a single track (the Pad track).

Exactly as with the Styles, when playing a chord in the chord recognition area, the corresponding Chord Variation is recalled. Recognized chords are associated to a Chord Variation by means of the Chord Variation Table. Each Pad contains a Chord Variation Table.

The Pad structure

The Pad structure is the same of a single-track Style Element, as shown in the following diagram:

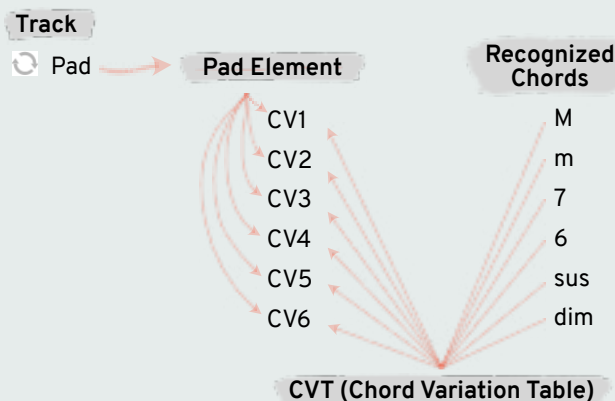

What to record in a Pad

Recording a Pad means recording Chord Variations for the Pad track. You don't need to record all Chord Variations. It is often only needed to record just a single Chord Variation.

Recorded MIDI data

When recording Styles and Pads, non-supported events are filtered out. Here are the allowed events.

Recorded MIDI data	CC#
Note	
RX Noise	
Pitch Bend	
Channel After Touch	
Modulation 1 (Joystick Y+)	01
Breath/Modulation 2 (Joystick Y-)	02
Pan	10
Expression	11
CC#12	12
CC#13	13
Ribbon	16
Damper (Hold 1)	64
Filter Resonance (Harmonic Content)	71
Release Time	72
Attack Time	73
Low Pass Filter Cutoff (Brightness)	74
CC#80 (Pa5X Sound Controller 1)	80
CC#81 (Pa5X Sound Controller 2)	81
CC#82 (Pa5X Sound Controller 3)	82
A/B Master FX 1 (reverb) send level	91
A/B Master FX 2 (modulation) send level	93
A/B Master FX 3 (free) send level	94

Accessing the Style and Pad Record mode

Accessing the Style Edit mode

You can edit and save the User Styles. Factory Styles are protected. If you access editing with a Factory Style, a temporary copy is automatically created in memory, and you will then be prompted to save it into a new User Style.

- 1 If you want to edit an existing Style, assign it to the selected Player.
- 2 Press the **REC/EDIT** button on the control panel to see the **Record/Edit** menu.

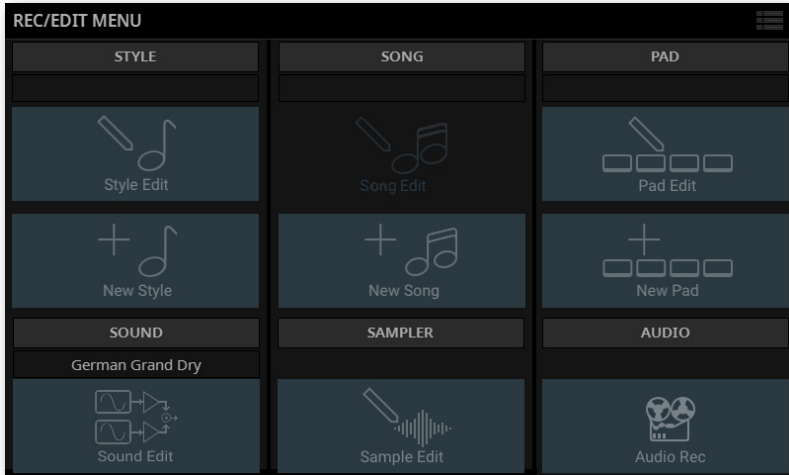

3 If you want to edit the current Style, touch the **Style Edit** button in the menu. If you want to create a new Style, touch the **New Style** button in the menu, and confirm if you agree to lose any unsaved changes. In both cases, the **main page** of the **Style Edit** mode will appear.

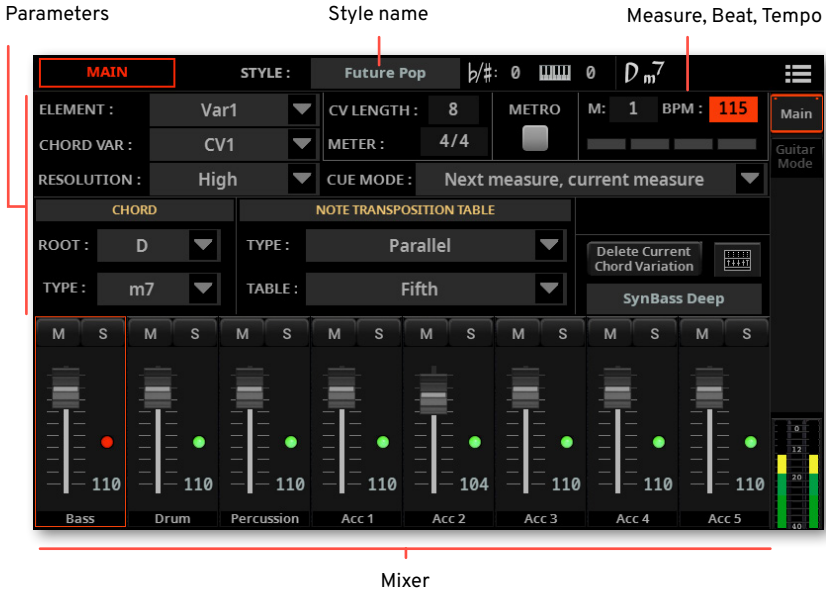

4 Press the **MENU** button on the control panel, and touch one of the buttons to choose the corresponding **edit section** of the **Style Edit** mode.

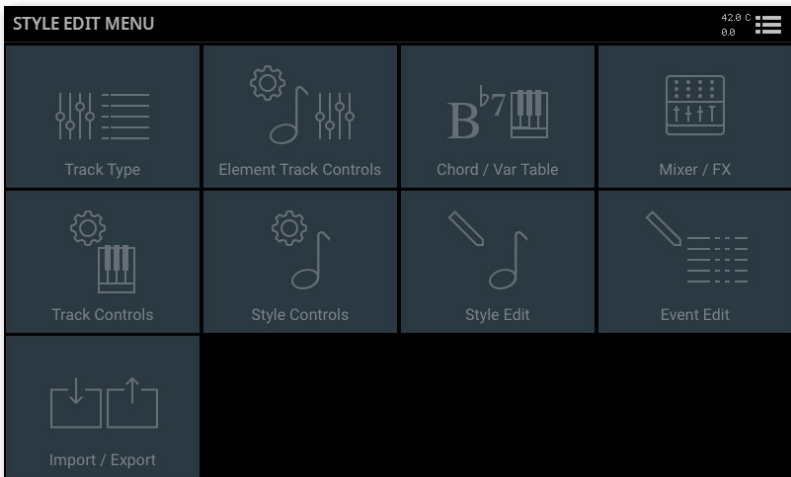

5 Press the **EXIT** button on the control panel to return to the **main page** of the **Style Edit** mode.

Saving the Style

When finished editing the Style, choose the **Save Style** command from the **page menu** (☰) to save the Style. More details on saving Styles at the end of this section.

Exiting the Style Edit mode

To exit from the **Style Edit** mode, press the **EXIT** or the **REC/EDIT** button again. A message will warn you that any unsaved data will be lost.

Accessing the Pad Edit mode

You can edit and save the User Pads. Factory Pads are protected. If you access editing with a Factory Pad, a temporary copy is automatically created in memory, and you will then be prompted to save it into a new User Pad.

- 1 If you want to edit the Pads contained in an existing Style, assign it to the selected Player. If you want to edit the Pads contained in a SongBook Entry, select it.
- 2 Press the **REC/EDIT** button on the control panel to see the **Record/Edit** menu.

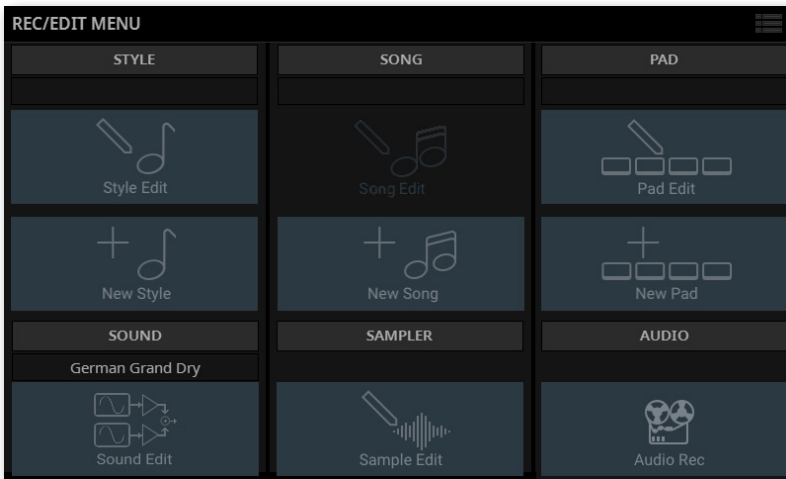

- 3 If you want to edit one of the selected Pads, touch the **Pad Edit** button in the edit menu. You are asked to choose one of the four Pads from the **Select Pad to Edit** window. Touch the **Pad** you want to edit.

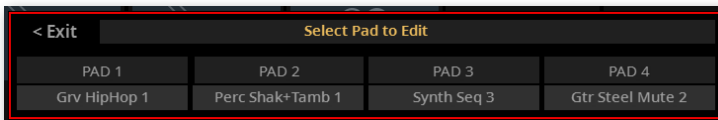

- 4 If you want to create a new Pad, touch the **New Pad** button in the edit menu.

5 The **main page** of the **Pad Edit** mode will appear.

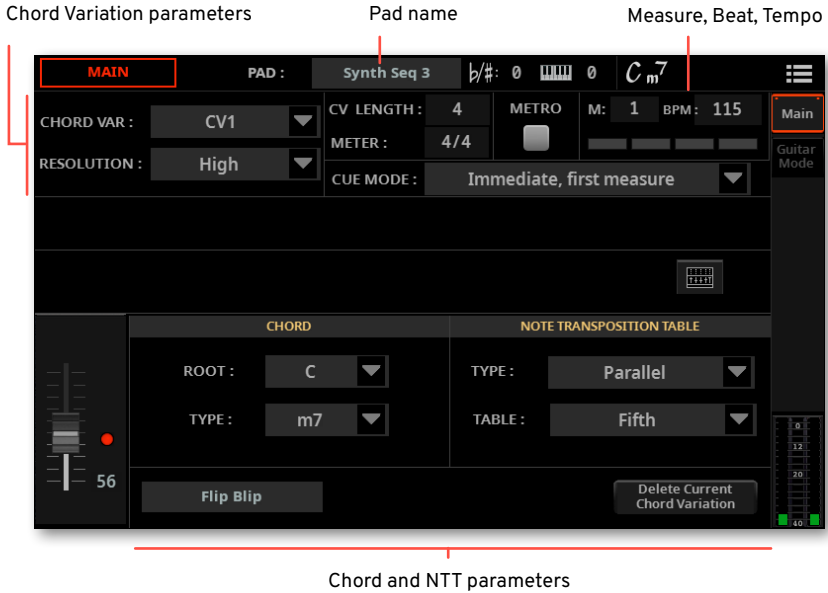

6 Press the **MENU** button on the control panel, and touch one of the buttons to choose the corresponding **edit section** of the **Pad Edit** mode.

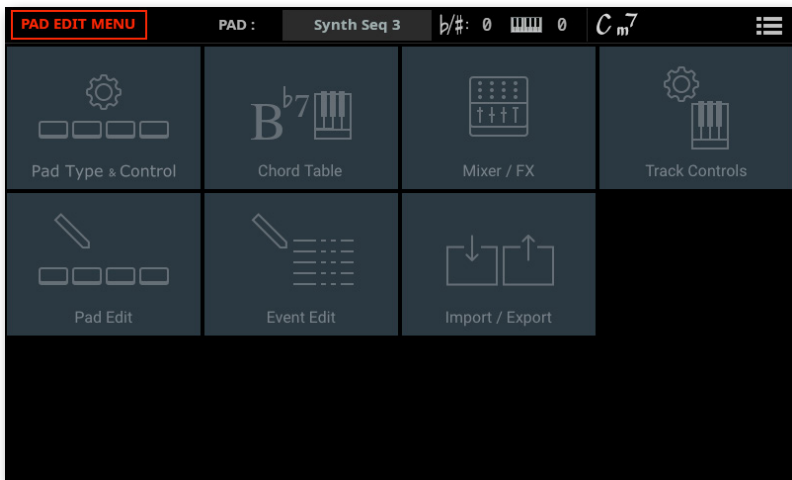

7 Press the **EXIT** button on the control panel to return to the **main page** of the **Pad Edit** mode.

Saving the Pad

When finished editing the Pad, choose the **Save Pad** command from the **page menu** () to save the Pad. More details on saving Pads at the end of this section.

Exiting the Pad Edit mode

To exit from the **Pad Edit** mode, press the **EXIT** or the **REC/EDIT** button again. A message will warn you that any unsaved data will be lost.

Listening to the Style or Pad

Testing chords

While in Style/Pad Edit mode, the keyboard can play chords to drive the recorded musical patterns. You can do it in **any edit page**, apart for the **Main** and **Event Edit** ones.

Listening to the results

- 1 Press the **MENU** button, and go to **one of the edit pages** (apart for the **Main** and **Event Edit** one).
- 2 Press the **PLAY/STOP** (▷□) button and play some chords to check how it works. Press the **PLAY/STOP** (▷□) button again to stop playback.
- 3 If you want to continue recording, press the **EXIT** button, and return to the **Main** page of the **Style/Play Edit** mode.

Choosing the Style and Pad Sounds

Style Sounds, Style Element Sounds

You can assign Sounds to the **Style as a whole**, and they will not change when changing Style Element (for example, when going from Variation 1 to Variation 2). These are the Sounds that you can assign while in the **Home** mode.

Or, you can assign different Sounds to **each Style Element**, to let them change when choosing a different Style Element. If you want to assign different Sounds to a Style Element, you can do it in the **Style Edit** mode.

Assigning Sounds to the Style

Choosing Sounds for the Style as a whole

The Sounds you assign to the Style while in the **Home** mode will be the main ones used by the Style. They may be overridden by Sounds assigned to each Style Element, as described in the next pages.

Having a single Sound assigned to a track for the whole Style is like having each player in a band playing the same instruments for the whole song, as it usually happens in a live gig. It is the recommended way, since it is also the easiest way to deal with the insert effects and EQ.

Please note that any change can only be saved into a User Style. If you want to customize a Factory Style, you can access editing with it, but will then be prompted to save to a User Style.

■ Assign Sounds to the Style tracks

- 1 With the User Style to be edited assigned to Player 1, go to any of the edit pages where the Sound names are shown. For example, go to the **Home > Menu > Mixer/FX > Main** page.

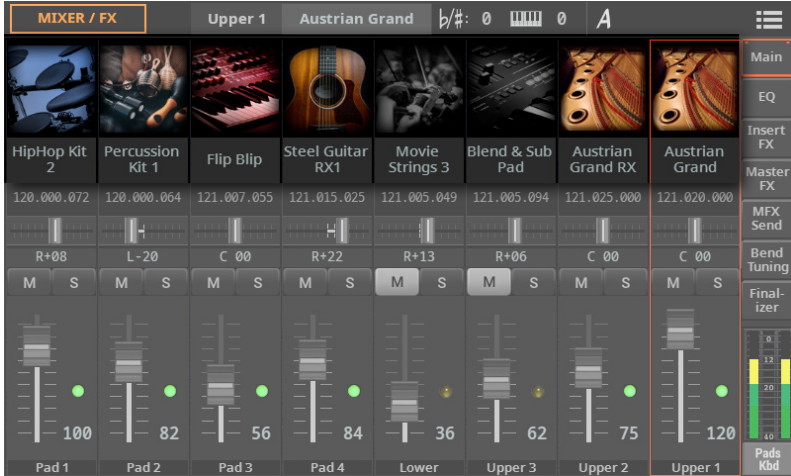

- 2 Touch the **TRACK SELECT** button in the bottom right corner to switch to the Style Sounds. The name of the button will change to **Style**.

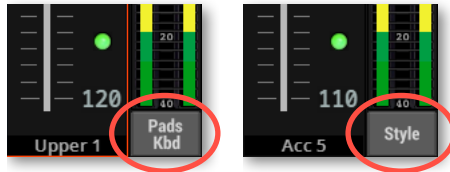

You will now see the name of the Sounds assigned to the Style tracks.



3 Touch the **name of the Sound** to open the **Sound Select** window, and choose a Sound for the track. When done, press the **EXIT** button to return to the current page.

■ Save the assigned Sounds

➤ When done assigning the Sounds to each track of the Style, save the changes by choosing the **Save Style** from the **page menu** (☰).

Drum and Percussion Kits

Drum Kits (including Percussion Kits) are special Sounds, where each note of the keyboard is a different percussive instrument. To preserve the kit's mapping, Drum Kits are not affected by transposition. Usually, you will assign Drum Kits to the **Drum** and **Percussion** track.

Digital Drawbars and the Style tracks

Digital Drawbars are special Sounds emulating the classic tonewheel organs. Settings for the Digital Drawbars assigned to the Style tracks are saved in the Style, and may be considered the equivalent of an organ's preset. You can have a single Digital Drawbars Sound for all the Style tracks. You can assign the same Digital Drawbars Sound to more Style tracks at once.

Assigning Sounds to the Style Elements

Choosing Sounds for each Style Element

You can assign different Sounds to each Style Element. This will allow, for example, to have an acoustic guitar as the accompaniment for Variation 1 (that will be used for a Verse), and an electric guitar for Variation 2 (that will be used for the Chorus).

■ Choosing a Sound from the Style Edit > Main page

1 Go to the **Style Edit > Main** page.



a. Select a track

b. Choose a Sound

2 Use the **Element** parameter to choose a Style Element. As an alternative, press the corresponding button on the control panel to select one of the **Style Elements** (INTRO 1 ... ENDING 3).

3 Touch the track to be selected in the **mixer** area.

4 Touch the **name of the Sound** to open the **Sound Select** window, and choose a Sound. When done, press the **EXIT** button to return to the current page.

5 Repeat the same operation for other tracks and Style Elements.

■ Choosing a Sound from other edit pages

The Sounds can be also chosen from any page of the Style Edit mode, where the name of the Sounds appear. For example, let's see how to do it in the main **Mixer/FX** page.

- 1 Go to the **Style Edit > Menu > Mixer/FX > Main** page.

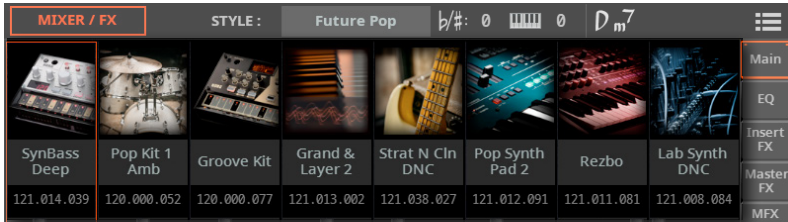

- 2 Press the corresponding button on the control panel to select one of the **Style Elements (INTRO 1 ... ENDING 3)**.
- 3 Touch the **name of the Sound** to be replaced, to open the **Sound Select** window, and choose a Sound. When done, press the **EXIT** button to return to the current page.
- 4 Repeat the same operation for other tracks and Style Elements.

Assigning a Sound to the Pad

Pads only have a single Style Element and track, so there is a single Sound for the whole Pad.

- 1 Go to the **Pad Edit > Main** page.

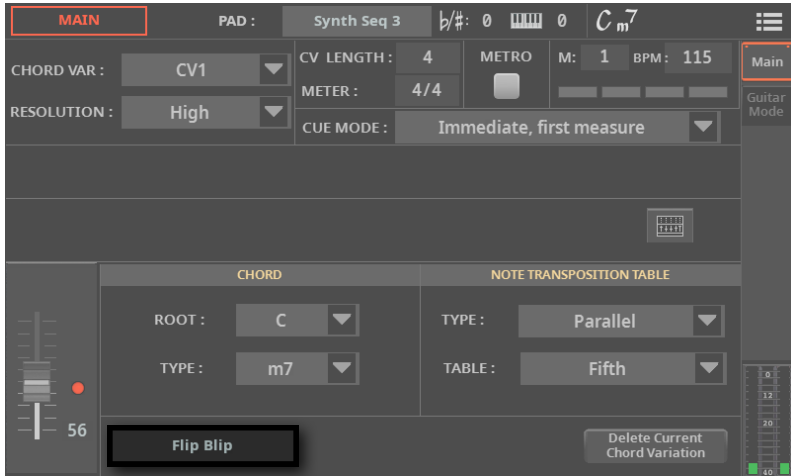

- 2 Touch the **name of the Sound** to open the **Sound Select** window, and choose a Sound. When done, press the **EXIT** button to return to the current page.

Recording the Styles or Pads in realtime

Setting the recording parameters

Choosing what to record

■ Choosing the Style track, Style Element and Chord Variation

With Styles, you record one or more **Chord Variations** for each **Style track**, inside a **Style Element**. This is the musical pattern you listen when playing a chord.

Pads are made of a **single Pad Element** and a single **Pad track**, so you only have to choose the **Chord Variation**.

- 1 Go to the **Style/Pad Edit > Main** page.
- 2 With Styles, choose the **Style track** to be recorded.

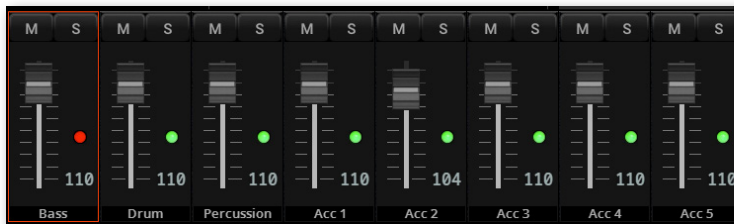

- 3 With Styles, use the **Element** pop-up menu to choose a **Style Element**. As an alternative, press the corresponding button on the control panel to select one of the **Style Elements** (**INTRO 1 ... ENDING 3**).

Each Style Element corresponds to a button on the control panel carrying the same name. After selecting a Style Element, select a Chord Variation for actual editing (see below).

Style Element

Intro1 ... End3

Meaning

Selected Style Element

4 Choose the Chord Variation to be recorded, and set the recording parameters.

With Styles:

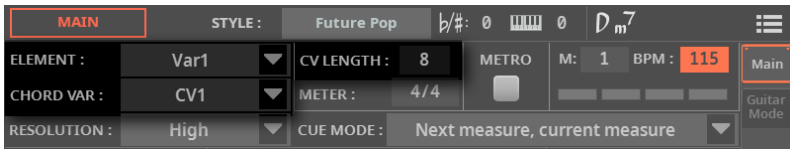

With Pads:

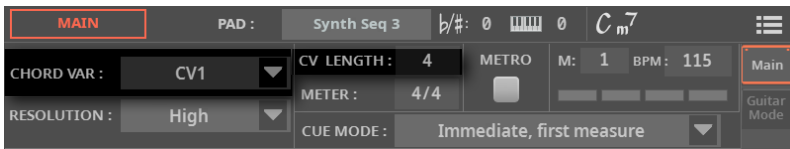

- Use the **Chord Var** pop-up menu to choose a **Chord Variation** inside the selected **Style/Pad Element**.

When the name of a Chord Variation is in lowercase and in round brackets, like (cs1) or (cs6), the Chord Variation is empty.

Style Element	Chord Variation
Var1, Var2, Var 3, Var4	CV1 ... CV6
Intro1, Intro2, Intro3, Fill1, Fill2, Fill3, Fill4, Break, Ending1, Ending2, Ending3	CV1 ... CV2

Pad Element	Chord Variation
Pad's single Element	CV1 ... CV6

■ Adjusting the total Chord Variation length

- Use the **CV Length** (Chord Variation Length) parameter to set the length of the Chord Variation (in measures).

The maximum length of the selected Chord Variation can be 32 measures. When playing a Style or Pad, this will be the overall length of the musical pattern.

You can only edit this parameter if the Chord Variation is still empty.

Tempo, Meter, Resolution

■ Setting the recording Tempo

While recording, you might want to use a different Tempo than the one saved in the Style. This alternative value will allow you, for example, to record at a slower speed, or to experiment with different values while listening what you recorded.

When playing Pads in Home mode, their Tempo is always that of the current Style or MIDI Song. While in record, you can choose a slower Tempo, to make recording easier.

- > Use the **BPM** parameter to set the recording Tempo value.

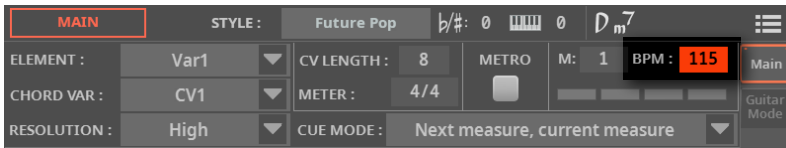

As an alternative, use the **TEMPO** buttons to change the recording Tempo.

This value will be saved in the Style, but not in the Pad.

HINT: In case you want to create Tempo variations in a Style, insert Tempo Scaling events in the Drum Track (Style Edit > Event Edit page). Pads always take Tempo values from the Style or MIDI Song assigned to the same Player.

■ Choosing the Meter of the Style Element or Pad

- > Use the **Meter** parameter to set the meter (time signature) of the Style Element or Pad.

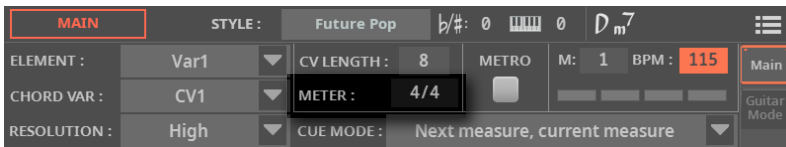



You can only edit this parameter if the Style Element or Pad is still empty.

■ Choosing the Resolution

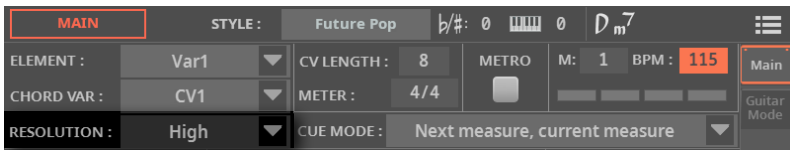
- > Use the **Resolution** parameter to set quantization during recording.



Quantization is a way of correcting timing errors; notes played too soon or too late are moved to the nearest axis of a rhythmic grid, set with this parameter, thus playing perfectly in time.

Resolution	Meaning
High	No quantization applied
1/32 ... 1/8	Grid resolution, in musical values. For example, when you select 1/16, all notes are moved to the nearest 1/16 division. When you select 1/8, all notes are moved to the nearest 1/8 division. The 1/12 and 1/24 values are triplets.
	No quantization 
	1/16 
	1/8 

Synchronizing

■ Cue mode for the Style and Pad Element

You can decide how a **Variation** or **Fill** Style Element will enter after having been selected.

> Go to the **Style/pad Edit > Main** page, and use the **Cue mode** pop-up menu to choose the way the Style/Pad Element will enter.

Cue mode	Meaning
Immediate, first measure	The Style Element enters immediately, and begins from the first measure. Only available on Fills.
Immediate, current measure	The Style Element enters immediately, and begins from the current measure. Only available on Fills.
Next measure, beginning	The Style Element enters at the beginning of the next measure, and begins from the first measure of the new pattern. Available on both Fills and Variations.
Next measure, current measure	The Style Element enters at the beginning of the next measure, and begins from the current measure. Only available on Variations.
Immediate, beginning	The Style Element enters immediately, and begins from the first measure of the new pattern. Only available on Fills.
Next beat, beginning	The Style Element enters at the next beat. Only available on Fills.

Choosing the original key/chord and the note transposition table

You will record the musical patterns in a particular key (say, C), matching a chord type (say, Major). You will then specify the chord root and type used by each track, to let the arranger transpose the recorded patterns to any other key.

■ Accessing the key/chord and note transposition table

1 Go to the **Style/Pad Edit > Main** page.

2 Select a Style track to be edited. Please note that these parameter do not apply to the Drum and Percussion tracks.

With Styles:

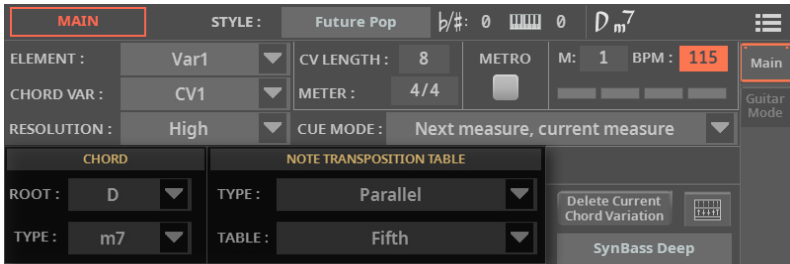

With Pads:



■ Choosing the Original Key/Chord for the selected track

> Use the **Chord > Root** and **Chord > Type** pop-up menus to define the original **key/chord root** and **chord type** for the **selected Style track** (or the **Pad track**) in the **current Chord Variation**.

When playing this exact chord, the recorded patterns will play without any transformation. No transposition, no processing will be applied.

When you select a track, the original key/chord assigned to the selected track will be shown. All recorded tracks will play back on that same key/chord. For example, if the original key/chord for the Acc1 track is A7th, when selecting the Acc1 track all the other tracks will play on the A7th key/chord.

In the example above, you will record the Acc1 track in the AMajor key, with notes pertaining to the A7th scale. This exact pattern will be recalled when an A7th chord will be recognized.

HINT: To conform to KORG specifications, it is advisable to record both the Major and minor Chord Variations for the Intro 1 and Ending 1 Style Elements.

■ Choosing an NTT for the selected track

> Use the **Note Transposition Table > Type** and **Table** parameters to choose an NTT (Note Transposition Table) for the **selected Style track** (or the **Pad track**) of the **current Chord Variation**.

An NTT is a set of sophisticated algorithms that lets the arranger know how to transpose pattern notes, when a chord that does not match the original chord of a Chord Variation is recognized.



For example, if you only recorded a Chord Variation for the CMaj chord, when a CMaj7 is recognized on the keyboard the arranger will transpose some notes to create the missing 7th.

NTT parameters are not used by Drum and Percussion tracks, and are therefore dimmed when selecting these tracks.

There are two types of NTTs, conceived for different cases:

NTT Type	Description
Parallel	All notes are transposed. These tables are ideally suited to melody parts.
Fixed	The arranger moves as few notes as possible, making legato lines and chord changes more natural. They are ideally suited to chord tracks (piano, strings, pads, etc...).

These are the NTT Type/Table combinations:

NTT Type	NTT Table	Description
Parallel	Root	<p>The root note (in CMaj = C) is transposed to the missing notes.</p>  <p>As recorded When playing a C7</p>
Parallel	Fifth	<p>The 5th note (in CMaj = G) is transposed to the missing notes.</p>  <p>As recorded When playing a C7</p>
Parallel	i-Series	<p>All original patterns must be programmed on the “Maj7” or “min7” chords. When loading old KORG i-Series Styles, this option is automatically selected.</p>  <p>As recorded When playing a C When playing a C7</p>
Parallel	No Transpose	<p>The chord shape is not modified, and is moved to the new key unchanged. The pattern plays exactly the recorded notes, and is moved to the new key as it is. This is the standard setting of Intro 1 and Ending 1 in KORG’s original Styles (where a chord progression is usually recorded).</p>
Fixed	Chord	<p>This table moves as few notes as possible, making legato lines and chord changes more natural. It is ideally suited to chord tracks (strings, piano etc...). Contrary to the Parallel mode, the programmed chord always stays in the proximity its original position, looking for common notes between the chords.</p>
Fixed	No Transpose	<p>The programmed notes are never transposed when chords are changed. They can’t even be transposed by the Master Transpose.</p>

To conform to KORG specifications, it is advisable to set the NTT to ‘Parallel/No Transpose’ on the Intro 1 and Ending 1.

Recording the Style or Pad

After having chosen the Style track, Style Element and Chord Variation, go on recording. Be sure to be in the **Main** page or the **Style Edit** or **Pad Edit** mode.

MAIN STYLE: Future Pop $b/\#$: 0 $\square\square\square\square$ 0 $D m^7$

ELEMENT: Var1 CV LENGTH: 8 METRO M: 1 BPM: 115 **Main**

CHORD VAR: CV1 METER: 4/4 Guitar Mode

RESOLUTION: High CUE MODE: Next measure, current measure

CHORD NOTE TRANSPOSITION TABLE

ROOT: D TYPE: Parallel Delete Current Chord Variation $\square\square\square\square$

TYPE: m7 TABLE: Fifth SynBass Deep

M S M S M S M S M S M S M S M S

Bass 110 Drum 110 Percussion 110 Acc 1 110 Acc 2 104 Acc 3 110 Acc 4 110 Acc 5 110

MAIN PAD: Synth Seq 3 $b/\#$: 0 $\square\square\square\square$ 0 $C m^7$

CHORD VAR: CV1 CV LENGTH: 4 METRO M: 1 BPM: 115 **Main**

RESOLUTION: High METER: 4/4 Guitar Mode

CUE MODE: Immediate, first measure

CHORD NOTE TRANSPOSITION TABLE

ROOT: C TYPE: Parallel Delete Current Chord Variation $\square\square\square\square$

TYPE: m7 TABLE: Fifth

56 Flip Blip

Using the metronome

- > Use the **Metro** checkbox to turn the metronome on or off while recording.

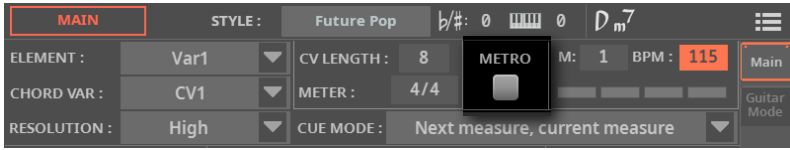

- > As an alternative, use **BUTTON #9 (Metro)** while the **CONTROL** section is in **STYLE/SONG** mode.

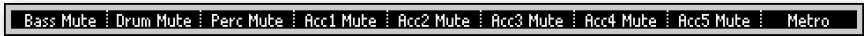

Recording

■ Select the Style track to record

- > While in the **Style Edit > Main** page, touch the track to be recorded. The red **Record (●)** icon will appear.

The Pad track is always enabled for recording.

■ Record

- 1 Press the **PLAY/STOP (▷□)** button to start recording.

A **1-measure precount** will play before the recording actually begins. When it begins, record freely.

While recording, the notes can be recorded and played back over the full keyboard range. The Local Control parameter is automatically set to On, to allow playing on the keyboard.

- 2 Recording will happen in **cycle**. The pattern will last for some measures, according to the **CV Length** value, then will start again from the beginning.

At any subsequent cycle, you can add notes and overdub the previous recording. This is very useful, for example, to record different percussive instruments at any cycle on a Drum or Percussion track.

- 3 When finished, press the **PLAY/STOP (▷□)** button to stop recording.

■ **Record other tracks of the same Chord Variation**

- While not recording, select a different track and go on recording all the tracks you want to record in the current Chord Variation.
-

■ **Record other Chord Variations of the Style Element or Pad**

- When finished recording the Chord Variation, you can select a different Chord Variation to complete the Style Element or Pad.
-

■ **Record other Style Elements of the Style**

- When finished recording the Style Element, record the other Style Elements to complete the Style.

Deleting the current Chord Variation

- > If you want to delete the selected Chord Variation, touch the **Delete Current Chord Variation** button, then confirm.

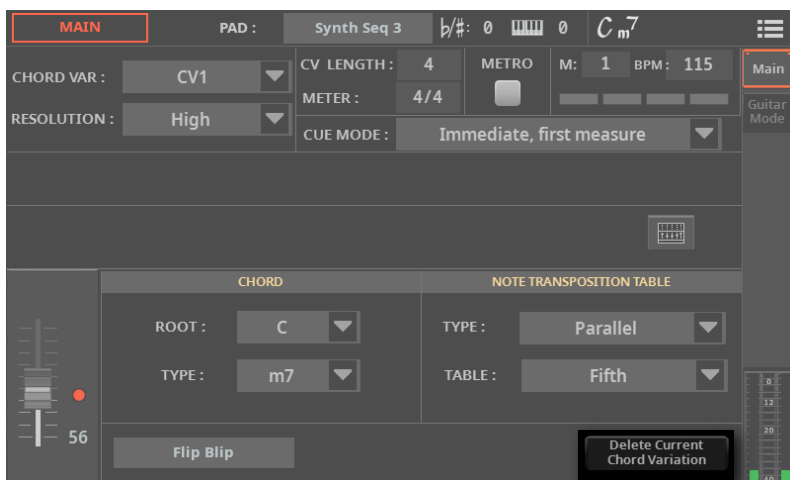
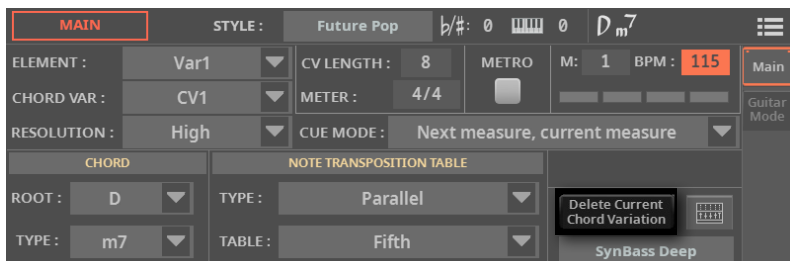

Saving the Style or Pad

- > When finished recording the new Style or Pad, choose the **Save Style** or **Save Pad** command from the **page menu** (☰) to save it.

Exiting the Style/Pad Record mode without saving

- > To exit the Style/Pad Edit mode without saving any change, press the EXIT button, or choose the **Exit from Record** command from the **page menu** (☰), and confirm.

Recording a Guitar track

Simulating a real guitar

Guitar Mode allows for easy creation of realistic rhythm guitar parts, without the artificial, unmusical playing typical of MIDI programming of guitar parts. In Guitar Mode, each chord is played according to its real position on the guitar neck, and not generated by simply transposing a written pattern.

Recording a Guitar track is unlike recording the other tracks, where you play exactly all the notes of a melody line or all the chords of an accompaniment part. With Guitar tracks you simulate how a guitar player uses his or her left and right hand, by doing the following:

- Play the keys corresponding to the strumming modes.
- Play an arpeggio using the six keys corresponding to the six guitar strings (and the special keys corresponding to the root and fifth notes).
- Play RX Noises and use Humanization to add realism to the pattern.
- Add regular patterns, for melodic or chordal passages.

Assigning a Sound to the Guitar track

- 1 While in **Home** mode, assign the User Style or Pad to be edited to Player 1.
- 2 Assign to the track to be used as the Guitar track a Guitar Sound. How to choose Sounds for Styles or Pads is described in [Choosing the Style and Pad Sounds](#) on page 742.
- 3 When done assigning the Sounds to the Guitar track, save the changes by choosing the **Save Style** from the **page menu** (☰).

The Guitar track recording procedure

Here is the general procedure to follow for recording a Guitar track in Guitar Mode.

■ Enable a Guitar track for recording

- 1 Access **Style Edit** or **Pad Edit** mode.
- 2 If the track is not set to be the Guitar track, set it to the correct type.
- > With Styles, go to the **Style Edit > Menu > Track Type > Type/Trigger/Tension** page.

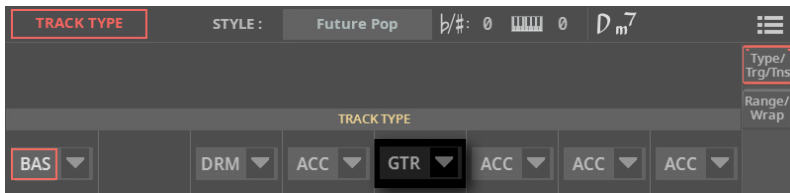

- > With Pads, to to the **Pad Edit > Menu > Pad Type & Control** page.

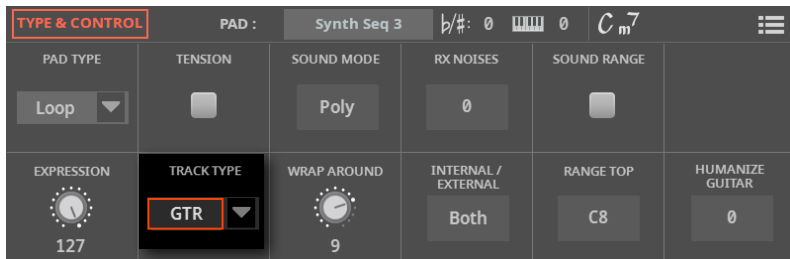

- 3 Set one of the Style's Accompaniment tracks, or the Pad track, as the **Guitar (GTR)** track.
- 4 While in the **Style Edit > Main** page, select the Style track set as the Guitar track. The **Guitar Mode** page will become available.

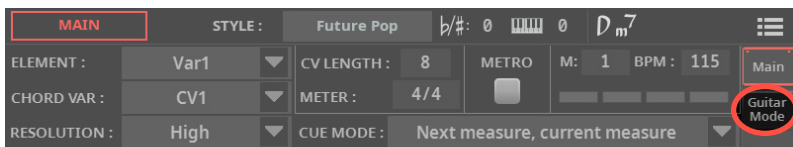

■ Access Guitar Mode and set the recording parameters

- 1 Select the Guitar track, and go to the **Guitar Mode** page.

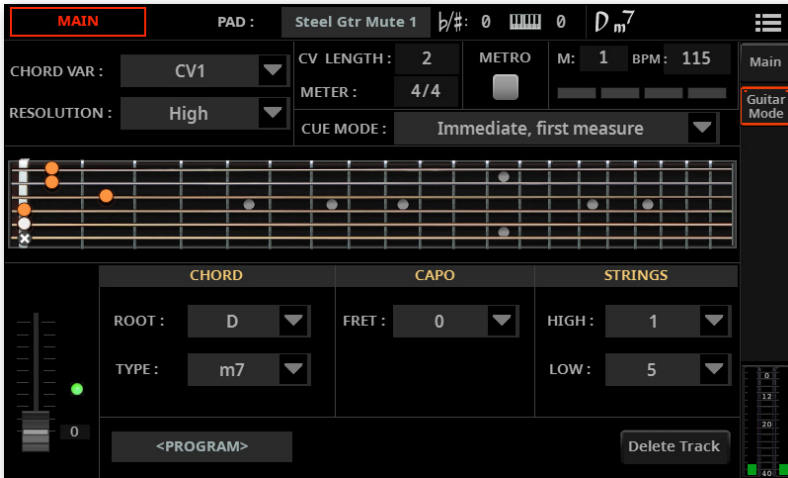
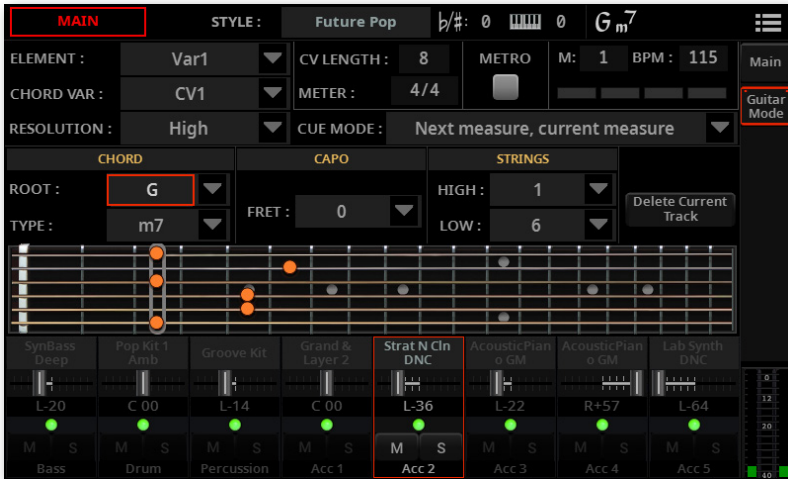

- 2 Set the recording parameters. Choose the **Style Element** and **Chord Variation**. If it is yet to be done, choose the **Recording Length**, to set the length of the pattern to be recorded.

With Styles:

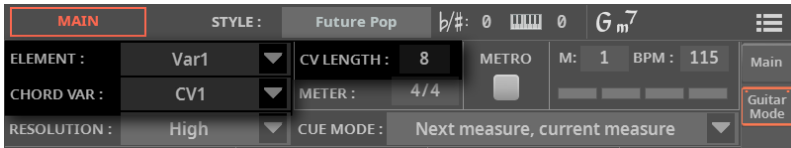

With Pads:



3 Set the **Root/Type** parameters, being sure they match the other tracks. For example, if you are recording the other tracks in Gm7, choose Gm7 for the Guitar track.

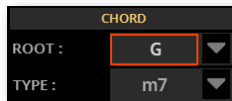

■ Start recording

- 1 Press the **PLAY/STOP** (▷□) button to start recording. After the 1-measure precount, start recording.
- 2 Record the guitar part. You can record what appears listed in the following diagram and table, by pressing the notes in the corresponding range. More details about these controls are later in this section.

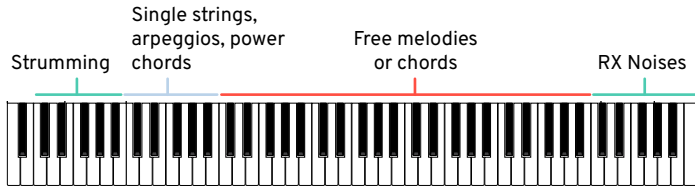

What	Where
Strumming (selects the position on the neck)	from C1 to B1
Single strings, arpeggios or power chords (selects the position on the neck)	from C2 to B2
Simple melodies or chords (similar to an Accompaniment track)	from C3 to B6
RX Noises (if included in the Sound)	from C7 to the end of the MIDI scale

- 3 Press the **PLAY/STOP** (▷□) button to stop recording.
- 4 If you want, go on, and record other Chord Variations of the same Style/Pad Element, then record other Style Elements of the Style.

The Guitar Mode page in detail

Most parameters in the **Guitar Mode** page are the same as in the **Main** page, but there are some parameters unique to playing the guitar.

Reading the fingerboard diagram

When recording strumming (in the range C1-B1) or arpeggios (C2-B2), you can see how a chord is composed on the fingerboard diagram.

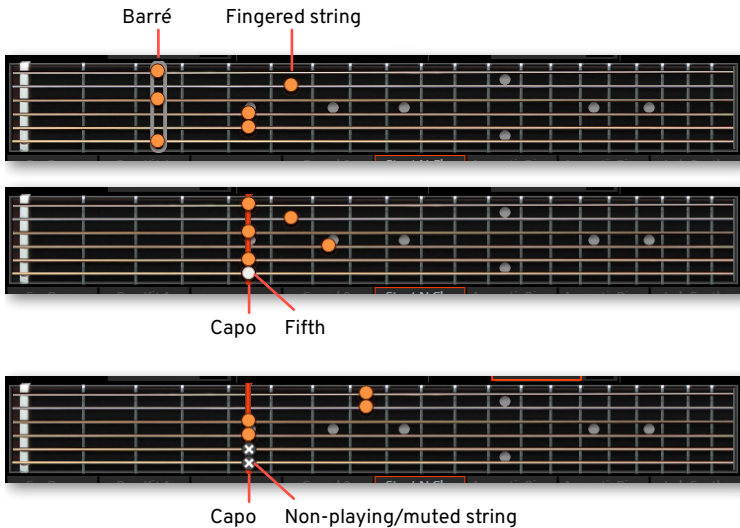

Here is the meaning of the various symbols:

Symbol	Meaning
Orange dot	Fingering (i.e., played note).
White dot	Fifth, playing on the D#2 key.
X	Non played or muted string.
Empty grey bar	Barré (a finger crossing all the strings, like a mobile capo).
Solid red bar	Capo.

Choosing a Key/Chord

With Guitar tracks, the **Chord** parameters usually sets the chord used for prelistening while programming the pattern.

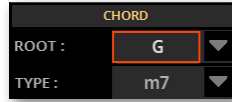

Intro 1 and Ending 1 behave in a different way, since they usually contain a chord progression.

Selecting a Capo

A capo (from the Italian ‘capotasto’, ‘head of fingerboard’) is a movable bar attached to the fingerboard of the guitar, to uniformly raise the pitch of all the strings. Its use makes the strings shorter, therefore changing the timbre and position of the chords (but not their shape).

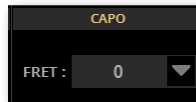

This might prevent some strings from sounding, depending on the chord position. The following example shows a C Major chord fingered with no capo, and the same chord with a capo on the fifth position.



- > Use the **Capo > Fret** pop-up menu to choose a Capo (‘capotasto’).

Capo	Meaning
0	Open string – no capo.
I ... XII	Position of the capo over the fingerboard (where “I” corresponds to the first fret, “II” to the second one, and so on).

Selecting the lowest and highest strings

You can choose a range of strings over which the pattern will play. For example, you might want to limit strumming to the highest notes, like in the typical funky rhythm guitar.

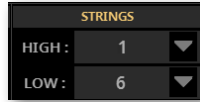

The following example shows the same C Major chord played on all six strings, on the highest four strings, then on the highest four strings, but with a capo added on the fifth fret.

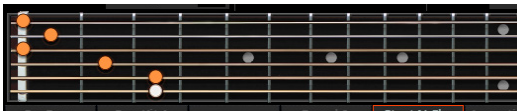

Strings 1-6, fret 0



Strings 1-4, fret 0



Strings 1-4, fret V

- > Use the **Strings > High/Low** parameter pair to choose the highest and lowest strings to play.

String	Meaning
1 ... 6	Selected string(s). The pattern will be played between these strings.

Recording the guitar pattern

After having set the various parameters, you can start recording the guitar. Each zone of the keyboard is dedicated to a particular technique.

Recording strumming

While recording, you can select a type of strumming.

> Press one of the keys in the octave from **C1 to B1**.

By pressing these keys, you play the corresponding type of strumming.



Note	Strum
C1	Full Down
C#1	Full Down Mute
D1	Full Up
D#1	Full Up Mute
E1	Full Down Mute Body
F1	Full Down Slow
F#1	Full Down Slow Mute
G1	Full Up Slow
G#1	Up Mute 4-Strings
A1	Down 4-Strings
A#1	Down Mute 4-Strings
B1	Up 4-Strings

Recording single strings, arpeggios or power chords

While recording, you can select single strings, power chords or fast arpeggios.

> Use the keys in the octave **from C2 to B2** to select single strings or power chords.

By pressing these keys, you can play arpeggios or power chords. You can either play a free arpeggio with the six guitar chords assigned to the keys from C to A, or play one of the faster arpeggios on the higher keys.

The root note is always available on the C# key, while the fifth note is always assigned to the D# key; with them, you can always play the lowest notes of an arpeggio.

This octave also includes a 'mute all strings' key (F#).



Note	String(s)
C2	VI String (E)
C#2	Recognized Chord Root
D2	V String (A)
D#2	Recognized Chord Fifth
E2	IV String (D)
F2	III String (G)
F#2	Mute All Strings
G2	II String (B)
G#2	Power Chord
A2	I String (e)
A#2	Full Down/Up
B2	Down/Up 4-Strings

Recording free melodies or chords

Together with strums and arpeggios, you can record regular patterns made of free melodies or chords, exactly as if the track was of the Accompaniment type. This is useful when you need some short melodic or chordal passages (for example, the closing of a strumming pattern, or a lead solo during an Intro or Ending).

You can record the pattern by playing in the range **from C3 to B6**, as shown by the diagram.



Recording RX Noises

RX Noises are noises generated on the guitar during a performance. Some are already included in the strumming patterns. Here you can add more to taste, for increased realism.

- > Press one of the keys **from C7 and up** to trigger RX Noises.



Note	RX Noise
C7 and up	RX Noises (depending on the Sound)

Choosing a Chord Shape

You can choose Chord Shapes in the **Event Edit** page, by entering a C0 note with different velocity values. The following table shows how a certain velocity value corresponds to how a chord is played in a particular position and on a certain number of strings.

Playing the same chord with different positions in the same pattern will simulate the typical behavior of a guitar player.

Out of the 88-note piano range



Velocity = Chord Shape

Vel.	Range	from Str.	to Str.	Position
0	6 Strings	I	VI	0
1	6 Strings	I	VI	0
2	6 Strings	I	VI	1
3	6 Strings	I	VI	2
4	6 Strings	I	VI	3
5	6 Strings	I	VI	4
6	6 Strings	I	VI	5
7	5 Strings Bass	II	VI	0
8	5 Strings Bass	II	VI	1
9	5 Strings Bass	II	VI	2
10	5 Strings Bass	II	VI	3
11	5 Strings Bass	II	VI	4
12	5 Strings Bass	II	VI	5
13	5 Strings Treble	I	V	0
14	5 Strings Treble	I	V	1
15	5 Strings Treble	I	V	2
16	5 Strings Treble	I	V	3
17	5 Strings Treble	I	V	4
18	5 Strings Treble	I	V	5
19	4 Strings Bass	III	VI	0
20	4 Strings Bass	III	VI	1
21	4 Strings Bass	III	VI	2
22	4 Strings Bass	III	VI	3
23	4 Strings Bass	III	VI	4
24	4 Strings Bass	III	VI	5
25	4 Strings Middle	II	V	0
26	4 Strings Middle	II	V	1
27	4 Strings Middle	II	V	2
28	4 Strings Middle	II	V	3
29	4 Strings Middle	II	V	4
30	4 Strings Middle	II	V	5
31	4 Strings Treble	I	IV	0
32	4 Strings Treble	I	IV	1
33	4 Strings Treble	I	IV	2

Vel.	Range	from Str.	to Str.	Position
34	4 Strings Treble	I	IV	3
35	4 Strings Treble	I	IV	4
36	4 Strings Treble	I	IV	5
37	3 Strings Bass	IV	VI	0
38	3 Strings Bass	IV	VI	1
39	3 Strings Bass	IV	VI	2
40	3 Strings Bass	IV	VI	3
41	3 Strings Bass	IV	VI	4
42	3 Strings Bass	IV	VI	5
43	3 Strings MiddleBas	III	V	0
44	3 Strings MiddleBas	III	V	1
45	3 Strings MiddleBas	III	V	2
46	3 Strings MiddleBas	III	V	3
47	3 Strings MiddleBas	III	V	4
48	3 Strings MiddleBas	III	V	5
49	3 Strings MiddleTreble	II	IV	0
50	3 Strings MiddleTreble	II	IV	1
51	3 Strings MiddleTreble	II	IV	2
52	3 Strings MiddleTreble	II	IV	3
53	3 Strings MiddleTreble	II	IV	4
54	3 Strings MiddleTreble	II	IV	5
55	3 Strings Treble	I	III	0
56	3 Strings Treble	I	III	1
57	3 Strings Treble	I	III	2
58	3 Strings Treble	I	III	3
59	3 Strings Treble	I	III	4
60	3 Strings Treble	I	III	5
61	2 Strings Bass	V	VI	0
62	2 Strings Bass	V	VI	1
63	2 Strings Bass	V	VI	2
64	2 Strings Bass	V	VI	3
65	2 Strings Bass	V	VI	4
66	2 Strings Bass	V	VI	5
67	2 Strings MiddleBas	IV	V	0

Vel.	Range	from Str.	to Str.	Position
68	2 Strings MiddleBas	IV	V	1
69	2 Strings MiddleBas	IV	V	2
70	2 Strings MiddleBas	IV	V	3
71	2 Strings MiddleBas	IV	V	4
72	2 Strings MiddleBas	IV	V	5
73	2 Strings Middle	III	IV	0
74	2 Strings Middle	III	IV	1
75	2 Strings Middle	III	IV	2
76	2 Strings Middle	III	IV	3
77	2 Strings Middle	III	IV	4
78	2 Strings Middle	III	IV	5
79	2 Strings MiddleTreble	II	III	0
80	2 Strings MiddleTreble	II	III	1
81	2 Strings MiddleTreble	II	III	2
82	2 Strings MiddleTreble	II	III	3
83	2 Strings MiddleTreble	II	III	4
84	2 Strings MiddleTreble	II	III	5
85	2 Strings Treble	I	II	0
86	2 Strings Treble	I	II	1
87	2 Strings Treble	I	II	2
88	2 Strings Treble	I	II	3
89	2 Strings Treble	I	II	4
90	2 Strings Treble	I	II	5

Editing the Styles and Pads

Choosing the Pad type

When triggered, Pads can play once or loop until you stop them.

- 1 Go to the **Pad Edit > Pad Track & Control** page.

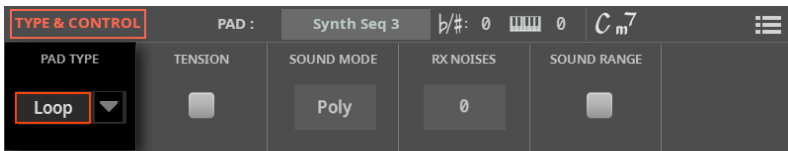

- 2 Use the **Pad Type** pop-up menu to choose the type of Pad.

There are two different categories of Pads: **Loop-type** (↻) and **One Shot-type** (→).

Pad type	Meaning
Loop	Cycling single-track patterns, that can be transposed by playing different chords on the keyboard – exactly as a Style track. They can also be Drum tracks, that will not be transposed.
One Shot	Single hits. While they are mostly used as non-transposing events, they can also be transposing notes or chords. Basically, they are single-note or single-chord patterns (see below).

Please note that, while in Pad Record, the pattern is always played back in loop, even if this parameter is set to One Shot.

Editing Volume and Expression

Style/Pad track volume

You can set the Volume (MIDI CC#07) value for each one of the Style tracks, and for the single Pad track. Please keep in mind that the Volume value is the same for all the Style Elements of a Style. For individual adjustments for each of the Style Elements, use Expression (MIDI CC#11) instead.

You can set the volume of the Style tracks from any page where the Volume sliders appear. The following one is an example that will help you adjust in parallel Volume and Expression.

- 1 Go to the **Style Edit > Menu > Element Track Controls > Expression** page.

The screenshot shows the 'EL TRK CONTROL' page for the 'Future Pop' style. The 'EXPRESSION' section is active, displaying eight tracks with their expression values and controls. The tracks are:

Track Name	Expression Value	Control Type
SynBass Deep	37	L-20
Pop Kit 1 Amb	100	C 00
Groove Kit	90	L-14
Grand & Layer 2	111	C 00
Strat N Cln DNC	100	L-36
AcousticPia no GM	127	L-22
AcousticPia no GM	127	R+57
Lab Synth DNC	75	L-64

Below the tracks, there are eight volume sliders for the following elements: Bass (110), Drum (110), Percussion (110), Acc 1 (110), Acc 2 (104), Acc 3 (110), Acc 4 (110), and Acc 5 (110). A 'Style' volume slider is also visible on the right side of the interface.

With Pads, go to the **Pad Edit > Menu > Pad Track a Control** page.

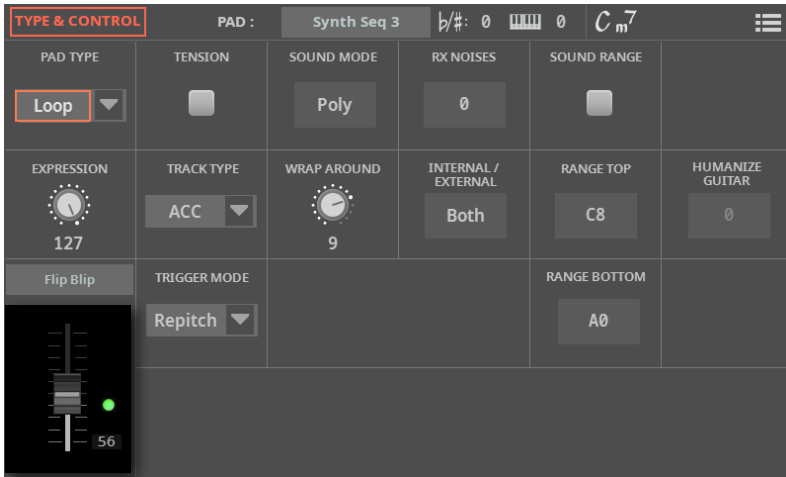

Style Element/Pad relative level (Expression)

You can set different Expression (MIDI CC#11) values for each of the tracks in a Style Element. Since Expression is a relative volume control, you can use it to lower the level compared to the overall volume of the Style.

This is especially useful to create a gradual volume change, for example of a string ensemble or a brass section after a sforzando. It is also useful when different Sounds are assigned to the same track in different Style Elements, and the level of these Sounds is different.

With Pads, Expression allows gradual volume changes, and can help balancing the Pads between them.

- 1 Go to the **Style Edit > Menu > Element Track Controls > Expression** page.

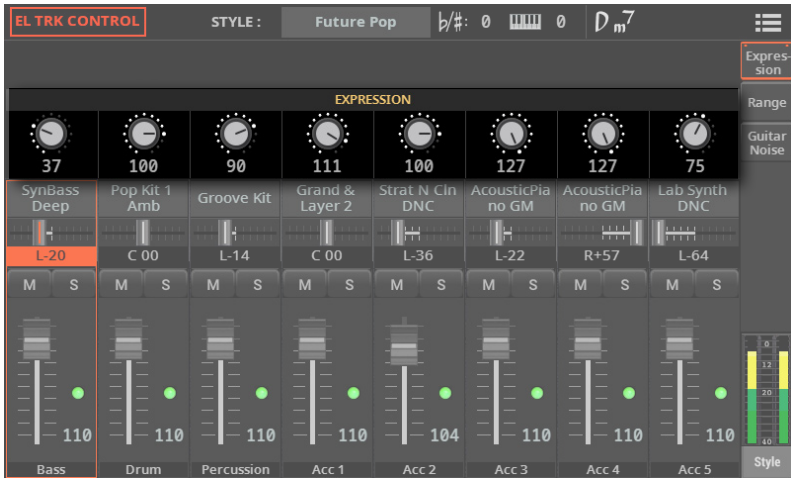

You set the **Expression** value for the Pad in the **Pad Edit > Menu > Pad Track a Control** page.

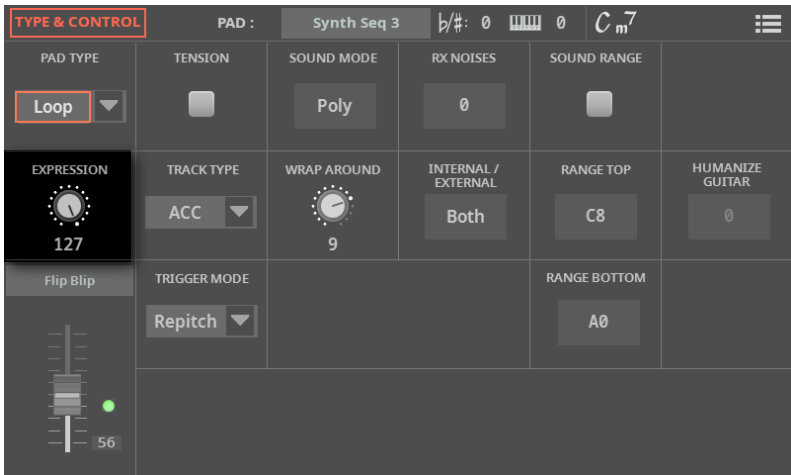

- 2 With Styles, press the corresponding button on the control panel to select one of the **Style Elements (INTRO 1 ... ENDING 3)**.

■ Adjust the Expression levels

You can quickly and easily adjust the Expression (CC#11) level of all the tracks in a Style Element. This allows for a more precise control over the volume level of all Style Element.

- 1 While in this page, select one of the Style Elements by pressing its button in the control panel.
- 2 Press the **PLAY/STOP** (▶□) button to start playback.
- 3 Use the **Expression** knobs to adjust the Expression level of the corresponding tracks.
- 4 Repeat the above operation with all the desired Style Elements.

A track's volume may be changed by an Expression event contained in a track. If you don't want this to happen, go to the Event Edit page and delete or edit it.

- 5 Press the **PLAY/STOP** (▶□) button to stop playback.

Editing the track type, trigger, tension

You can edit the track type, its response to retriggering, and add harmonic tension.

- 1 Go to the **Style Edit > Menu > Track Type > Type/Trigger/Tension** page.



You can access these parameters for the Pad in the **Pad Edit > Pad Track & Control** page.

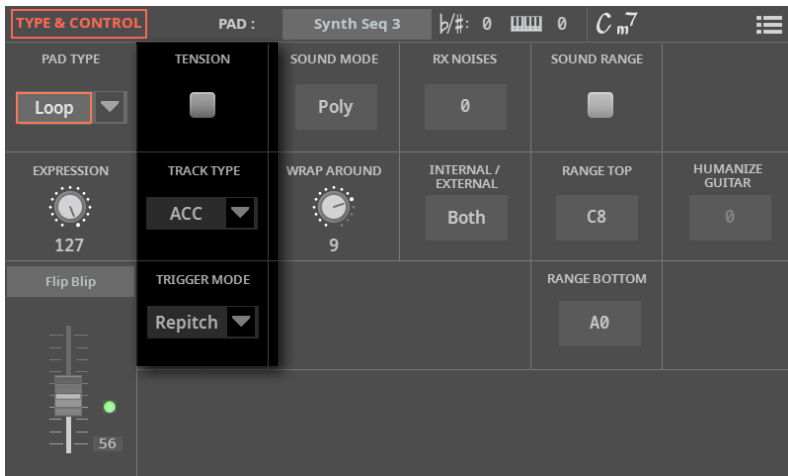

- 2 With Styles, press the corresponding button on the control panel to select one of the **Style Elements (INTRO 1 ... ENDING 3)**.

■ Choose the Track Type

- Use the **Track Type** parameter to set the type of the corresponding track.

Track type	Meaning
Accompaniment (ACC)	When a chord is recognized, the original notes are transposed to match the recognized chord, according to the selected Note Transposition Table (NTT).
Bass (BAS)	It behaves like the Accompaniment tracks, but playing the chord's root (or the bass note of a slashed chord).
Drum/Percussion (DRM)	No transposition is applied. The original pattern plays always. This is useful to avoid a Drum Kit, an SFX or a Sliced Loop to be transposed.
Guitar (GTR)	When a chord is recognized, the arranger triggers the original pattern on a 'virtual guitar', keeping care of how notes are played on the guitar fretboard. Please note that a Guitar track may also contain some patterns typical of an Accompaniment track – a useful addition for short 'free-form' passages, like a short lead solo.

■ Select the Trigger Mode

- Use the **Trigger Mode** parameter to define how Bass- and Acc-type tracks are retriggered when the chord is changed. This also works in the Acc-like zone of a Guitar track.

Trigger Mode	Meaning
Off	Each time you play a new chord, current notes will be stopped. The track will remain silent until a new note will be played by the pattern.
Retrigger (Rt)	The sound will be stopped, and new notes matching the recognized chord will be played back.
Repitch (Rp)	Notes already playing will be repitched to match the recognized chord. There will be no break in the sound. This is very useful on Guitar, Bass, Strings and Brass tracks.

■ Choose the Tension

- Select the **Tension** checkbox to make the accompaniment's harmony richer and more interesting, by adding tension.

Tension adds notes (a 9th, 11th and/or 13th) that have actually been recognized in the played chord, but aren't written in the Style/Pad pattern (usually programmed up to the 7th).

■ Testing the pattern

- 1 Press the **PLAY/STOP** (▶□) button to start the Style or Pad.
- 2 Play some chords and choose the different Style Elements, to test the patterns with the new settings.
- 3 Press **PLAY/STOP** (▶□) button again to stop playback.

Setting the key range and wrap-around point

The Sounds, like the acoustic instruments they imitate, sound better in their natural range. When the accompaniment pattern exceeds this range, it can be transposed to fall in the best range.

Enabling the Sound Key Range

You can enable or disable the alternative Key Range of the instrument.

- 1 Go to the **Style Edit > Menu > Track Type > Range/Wrap** page.



You can access these parameters for the Pad in the **Pad Edit > Pad Track & Control** page.

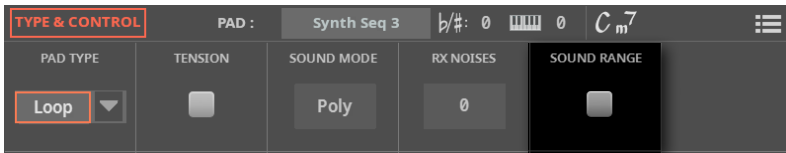

- 2 With Styles, press the corresponding button on the control panel to select one of the **Style Elements (INTRO 1 ... ENDING 3)**.

3 Use the **Sound Range** checkbox to turn the Key Range on/off for each Sound.

Kbd Range	Meaning
On	The Sound's Key Range is considered. When a track goes over the lower or higher Key Range point, it is automatically transposed, to remain inside the programmed range.
Off	No Sound's Key Range considered.

Setting the Sound Key Range

Setting the Key Range automatically transposes any pattern's note that would otherwise play too high or too low in pitch, compared to the original acoustic instrument's natural range, when transposed by the arranger. This will result in more natural sounding instruments.

For example, the standard lower limit for a concert flute is C4. The transposed pattern could exceed this limit, and sound unnatural. A Bottom limit set to C4 for the flute track will solve the problem.

Different Key Range values can be set for each Style Element. This will help forcing a preferred range in a particular section of the song, to simulate a particular piano comping style, adapt to the arrangement, or to avoid overlapping of instruments over different tracks.

1 Go to the **Style Edit > Menu > Element Track Controls > Range** page.

The screenshot displays the 'EL TRK CONTROL' interface for a 'Future Pop' style. The interface is organized into columns for different instruments: Bass, Drum, Percussion, Acc 1, Acc 2, Acc 3, Acc 4, and Acc 5. Each column has a 'Range' section with 'TOP' and 'BOTTOM' limits. The 'Bass' track is selected, showing a range of L-20. Other tracks include Pop Kit 1, Groove Kit, Grand & Layer 2, Strat N Cln, Pop Synth, Rezbo, and Lab Synth. The 'Range' section is highlighted, and the 'Bass' track is selected.

Instrument	TOP	BOTTOM
A3	G9	D1
G9	G#4	C-1
G#4	E6	C3
E6	G9	E1
G9	G9	C-1
D3	D3	C-1
		D2

Instrument List:

- SynBass Deep (L-20)
- Pop Kit 1 Amb (C 00)
- Groove Kit (L-14)
- Grand & Layer 2 (C 00)
- Strat N Cln DNC (L-36)
- Pop Synth Pad 2 (L-22)
- Rezbo (R+57)
- Lab Synth DNC (L-64)

Volume/Level values:

- Bass: 110
- Drum: 110
- Percussion: 110
- Acc 1: 110
- Acc 2: 104
- Acc 3: 110
- Acc 4: 110
- Acc 5: 110

You set the **Key Range** for the Pad in the **Pad Record > Pad Track Controls > Settings** page.

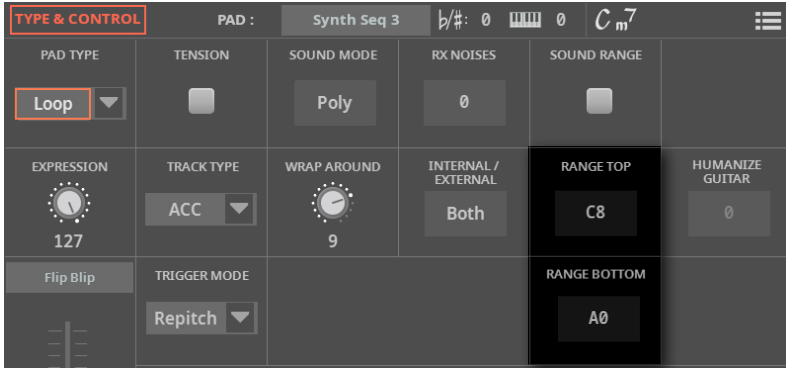

2 With Styles, press the corresponding button on the control panel to select one of the **Style Elements (INTRO 1 ... ENDING 3)**.

3 Use the **Top** and **Bottom** parameters to set the bottom and top limit of the keyboard range for the corresponding track of the selected Style Element.

While recording in the **Main** page, the Key Range is ignored. It will be used when playing back the Style and in the edit pages.

4 Press the **PLAY/STOP (▷□)** button and play some chords to check how it works. With Styles, select any Style Element using the control panel button. Press the **PLAY/STOP (▷□)** button again to stop playback.

Setting the Wrap Around point

You can set the wrap-around point for each Sound.

- 1 Go to the **Style Edit > Menu > Track Type > Range/Wrap** page.

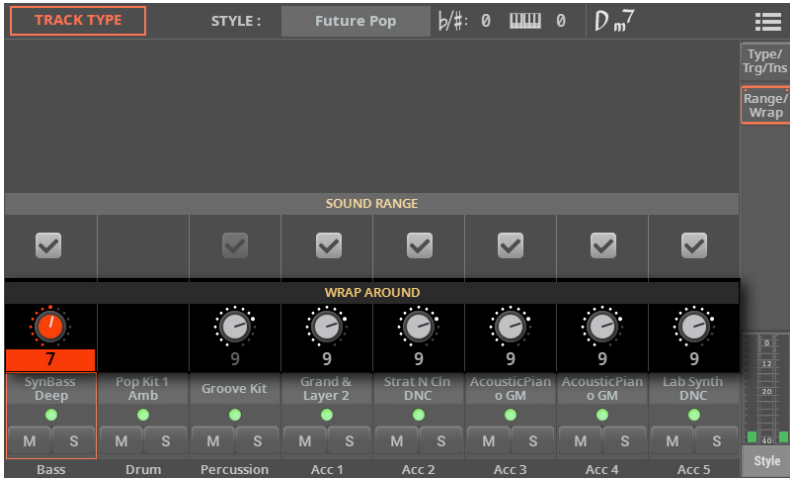

You can access these parameters for the Pad from the **Pad Edit > Menu > Pad Track & Control** page.

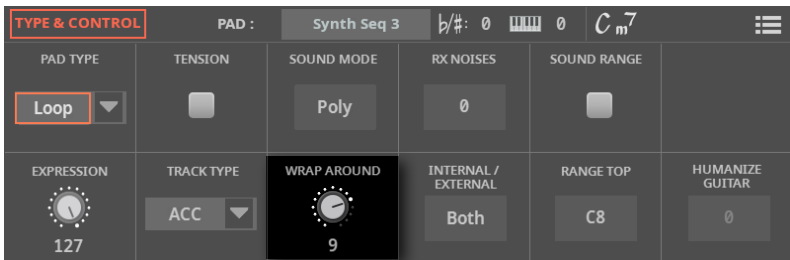

2 Use the **Wrap Around** knob to set a wrap-around point.

The wrap-around point is the highest key for the accompaniment track. When the detected chord's pitch is too high, the Style (or Pad) pattern might be transposed to a range that is too high, therefore sound unnatural. So, when the pattern reaches the wrap-around point, it will jump to a lower octave.

It is advisable to set different wrap-around points for each track, to avoid that all tracks 'jump' to a different octave at the same time. For more realistic results, we suggest to consider the actual range of the real instrument.

Wrap Around	Meaning
1 ... 12	Maximum transposition (in semitones) of the track, referred to the original Key/Chord of the Style pattern.

Adjusting the RX Noise level

You can set the RX Noises level. These are all the extraneous noises generated while playing some instruments, in particular acoustic or electric guitars and bass guitars.

- 1 Go to the **Style Edit > Menu > Element Track Controls > Guitar/Noise** page.



You set the **RX Noise** parameter for the Pad in the **Pad Edit > Menu > Track & Control** page.

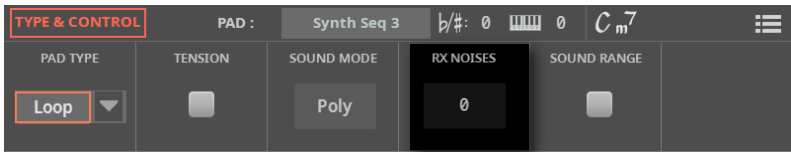

- 2 With Styles, press the corresponding button on the control panel to select one of the **Style Elements (INTRO 1 ... ENDING 3)**.
- 3 Use the **RX Noise** parameters to adjust the volume of RX Noises in the corresponding tracks. This control applies to all types of tracks (provided the Sound contains RX Noises).

Editing Guitar Humanization

You can set the ‘human feel’ of the Guitar tracks.

- 1 Go to the **Style Edit > Menu > Element Track Controls > Guitar/Noise** page.



You set the **RX Noise** and **Humanize** parameters for the Pad in the **Pad Edit > Menu > Track & Control** page.



- 2 With Styles, press the corresponding button on the control panel to select one of the **Style Elements (INTRO 1 ... ENDING 3)**.

3 Use the **Humanize Guitar** parameters to apply a random value to the position, velocity and length of notes of Guitar tracks. This only works on tracks set to the **Guitar** type (in the **Style Edit > Track Type > Type/Trigger/Tension** page, or the **Pad Edit > Track & Control** page).

- 4 Press the **PLAY/STOP (▷◻)** button and play some chords to check how it works. Select any Style Element using the control panel button. Press the **PLAY/STOP (▷◻)** button again to stop playback.

Editing the Chord Table

You can assign a Chord Variation to each of the main recognized chord. When a chord is recognized, the assigned Chord Variation will be automatically selected by the arranger to play the accompaniment.

- 1 Go to the **Style Edit > Menu > Chord/Variation Table > Chord Table** page.



- With a Pad, go to the **Pad Edit > Menu > Pad Chord Table > Chord Table** page.

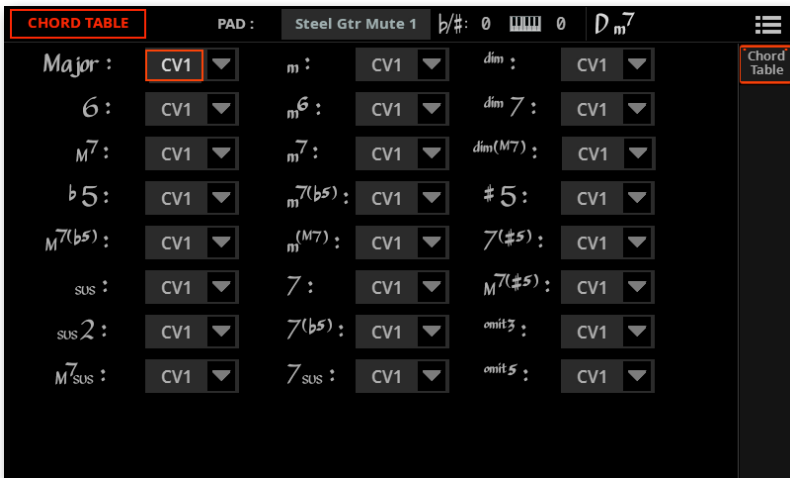

- 2 With Styles, select one of the **Style tracks** on the bottom of the page.

- 3 With Styles, press the corresponding button on the control panel to select one of the **Style Elements (INTRO 1 ... ENDING 3)**. Pads have no Style Elements.
- 4 Use the **Chord Variation** pop-up menus to assign a Chord Variation to each of the chords.
- 5 Press the **PLAY/STOP (▷□)** button and play some chords to check how it works. Select any Style Element using the control panel button. Press the **PLAY/STOP (▷□)** button again to stop playback.

Checking the available Chord Variations

You can see which of the Style tracks and Style Elements contain Chord Variations, and which of the Chord Variations contains data. Pads only include a single track and a single Pad Element, so don't need this page.

- 1 Go to the **Style Edit > Menu > Chord/Variation Table > Chord Variations** page.
- 2 Select one of the tracks to see the assigned Chord Variations.

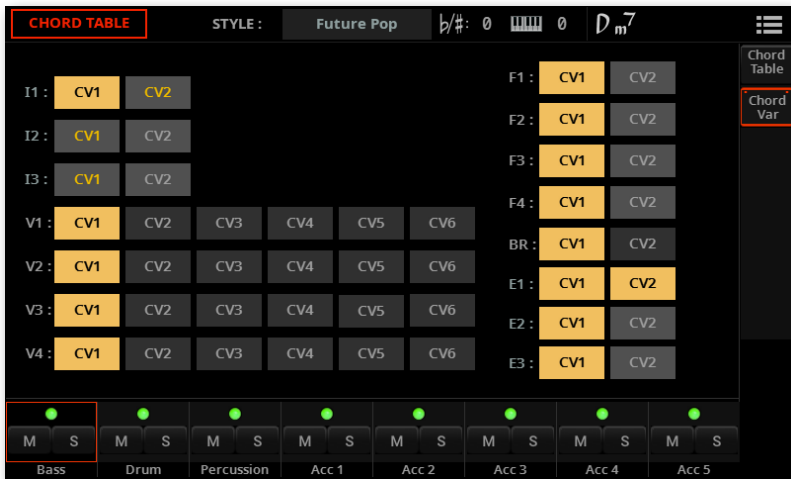

Cell status

Meaning

Yellow background	The Chord Variation is available for the selected track.
Yellow text on grey background	The Chord Variation is not available for the selected track, but it is available for other tracks.
White text on grey background	The Chord Variation is not available in any track.

While in the **Chord Table** page you can see which Chord Variations have been used in the current Style Element Track, this page lets you get an overview on which Chord Variations are contained in the whole Style. If there are unused Chord Variations, you may choose to delete them to make the Style file lighter, or to assign them to a chord. On the contrary, you might see that additional Chord Variations are needed for one or more Style Elements.

The Mixer and the Effects

Mixing the Style Sounds and adding the Effects can be done in the same way seen for all the other types of Sounds. For more details, see [The Mixer on page 337](#).

1 To access the Mixer and the Effect, go to the **Style/Pad Edit > Menu > Mixer/FX** pages.

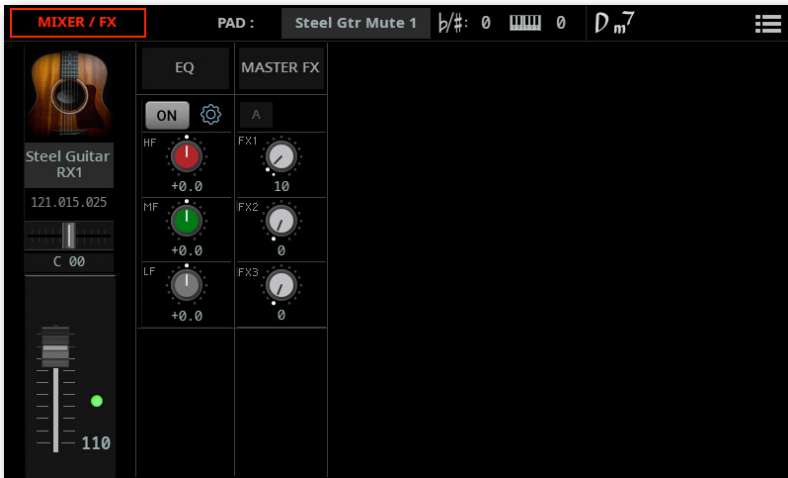

You can also jump to this page by touching the **Mixer** () button in the **Style/Pad Edit > Main** page.

2 Edit the mixer and effect parameters. Please note that Styles and Pads make use of the FX Group A.

Track Type and Poly/Mono mode

Editing the Style Track Type and Poly/Mono mode can be done in the same way seen for all the other types of Sounds. For more details, see [The Track parameters](#) on page 391.

- 1 To access the Track Type and Poly/Mono mode, go to the **Style Edit > Menu > Track Control > Mode** page.

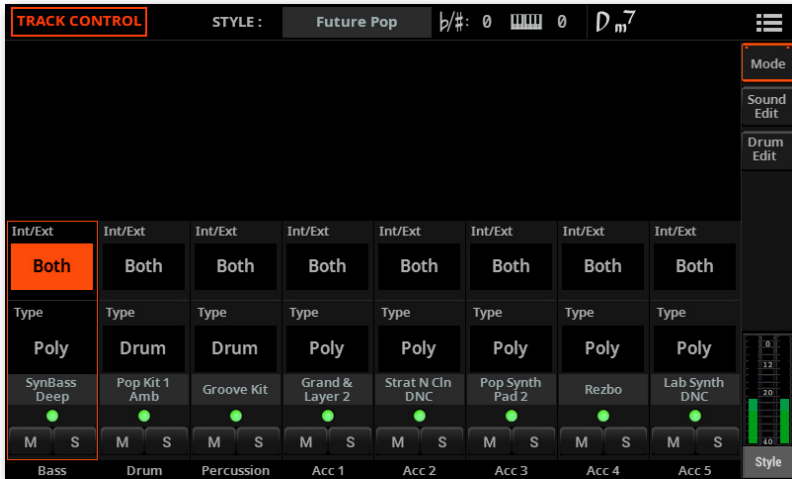

With Pads, go to the **Pad Edit > Menu > Pad Track & Control** page.

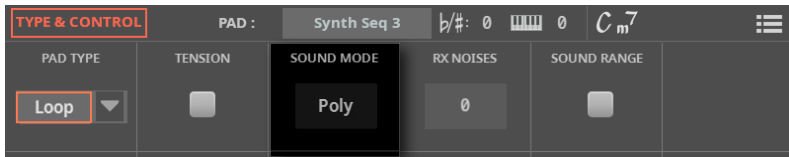

- 2 Edit the parameters.

Quick Sound Edit and Drum Edit

Editing the Style Track Type and Quick Sound Edit can be done in the same way seen for all the other types of Sounds. For more details, see [The Track parameters](#) on page 391.

- 1 To access the Quick Sound Edit and Drum Edit, go to the **Style Edit > Menu > Track Control > Sound Edit** or **Drum Edit** pages.



- 2 With Styles, before editing the parameters for a track, choose the Style Element in which it is contained. Press the corresponding button on the control panel to select one of the **Style Elements (INTRO 1 ... ENDING 3)**.

Choosing a Fill Mode for each Fill/Break

The Fill Mode parameters allow for automatically choosing a Variation at the end of each Fill, after having pressed one of the **FILL** or **BREAK** buttons. These settings can be saved to a Style or a SongBook Entry, so you can have a different Fill Mode configuration for each Style or Song in a SongBook Entry.

- 1 Go to the **Style Edit > Menu > Style Controls > Fill Mode** page.



As an alternative, you can access these parameters in the **Home > Menu > Style Controls > Fill Mode** page.

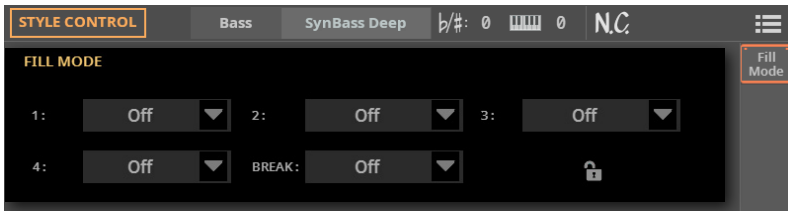

- 2 Use the **Fill Mode > 1...5/Brk** pop-up menus to choose a Fill Mode for the corresponding Fill/Break.

Fill Mode	Meaning
Off	The same Variation, playing before selecting a Fill, will be selected again.
1&2 ... 3&4	The specified Variations will be alternatively selected, when one of them is selected. For example, with the 1&2 option, if Variation 1 is selected, Variation 1 and Variation 2 will be alternatively selected after the end of the Fill.
Up/Down	The next higher/lower numbered Variation is selected, in cycle. After Variation 4, an Up command will select Variation 1. After Variation 1, a Down command will select Variation 4.
Increase/Decrease	The next higher/lower numbered Variation is selected. When Variation 4 is reached, an Inc command will select Variation 4 again. When Variation 1 is reached, a Dec command will select Variation 1 again.
Variation 1 ... 4	Fill to Variation (→1, →2, →3, →4) automatically selects one of the four available Style Variations at the end of the fill.

Auto Fill and Fill Mode

Auto Fill and **Fill Mode** can interact, by doing strictly related things:

- > When the **Auto Fill** is enabled (**AUTO FILL** indicator on), you can choose a Variation by pressing one of the **VARIATION** buttons. This will automatically select a Fill, then the chosen Variation. This is the easiest way to select the Variation best fitting the next song section, and let the instrument automatically choose a Fill for you.
- > When the **Fill Mode** is programmed in a Style or SongBook Entry, you can choose a Fill or Break by pressing one of the **FILL** or **BREAK** buttons. The chosen Fill or Break will be played back, then the programmed Variation will be automatically selected. This is a sophisticated way of creating complex pattern patterns of Fills and Variations.

Please note that, while **Auto Fill** is a global setting, **Fill Mode** is tied to a Style or SongBook Entry.

Copying the Style/Pad patterns

You can copy the Style/Pad pattern data in the **Style/Pad Edit > Style/Pad Edit** section. With Pads, you cannot select a track or Style Element to edit.

Copying from a Style

You can copy a track, Chord Variation or Style Element from the same or a different Style. Be warned that copying will overwrite all data at the target.

- 1 Go to the **Style/Pad Edit > Menu > Style/Pad Edit > Copy from Style** page.

STYLE EDIT STYLE : Future Pop b/#: 0 0 0 D_m⁷

FROM STYLE : <current> Select Current

FROM E: Var1 TRACK: Acc1 CV: All

TO E: Var1 TRACK: Bass CV: All

Execute

SynBass Deep	Pop Kit 1 Amb	Groove Kit	Grand & Layer 2	Strat N Cln DNC	AcousticPiano GM	AcousticPiano GM	Lab Synth DNC
M S	M S	M S	M S	M S	M S	M S	M S
Bass	Drum	Percussion	Acc 1	Acc 2	Acc 3	Acc 4	Acc 5

PAD EDIT PAD : Steel Gtr Mute 1 b/#: 0 0 0 D_m⁷

FROM STYLE : <current> Select

FROM E: All TRACK: Perc CV: All

TO CV: All

Execute

Steel Guitar RX1

110 C 00

2 Use the **From Style** parameter to choose the source Style.

> If you want to copy a Chord Variation to a different Chord Variation in the same Style, leave the “current” Style selected as the source.



> If you want to copy from a different Style, touch the **Select** button, and choose the source Style.



> If you want to choose the current Style again, touch the **Current** button.

3 Press the corresponding button on the control panel to quickly choose one of the **Style Elements (INTRO 1 ... ENDING 3)**. As an alternative, use the **Element** pop-up menu.

4 Use the **From E** pop-up menu to choose the source Style Element (E), and the **To E** pop-up menu to choose the target one.

E (Style Element)	Meaning
All	All Style Elements, i.e. the whole Style. You can't change the target, that is automatically set to All.
Intro1 ... End3	Single Style Element.

Due to the different structure, you can only copy over similar Style Elements, for example from a Variation to another Variation.

5 Use the **From Track** pop-up menu to choose the source track, and the **To Track** pop-up menu to choose the target one.

Track	Meaning
All	All tracks of the selected Style, Style Element or Chord Variation.
Bass ... Acc5	Single track of the selected Style, Style Element or Chord Variation.

6 Use the **From CV** pop-up menu to choose the source Chord Variation (CV), and the **To CV** pop-up menu to choose the target one.

CV (Chord Variation)	Meaning
All	All Chord Variations, i.e. the whole Style Element. You can't change the target, that is automatically set to All.
CV1 ... CV6	Single Chord Variation. The available Chord Variation can be different in the different Style Elements.

7 After having set the various parameters, touch the **Execute** button. Be warned that copying will overwrite all data at the target.

Copying from a Pad

You can copy a Chord Variation or all of a Pad's Chord Variations.

- 1 Go to the **Style/Pad Edit > Menu > Style/Pad Edit > Copy from Pad** page.

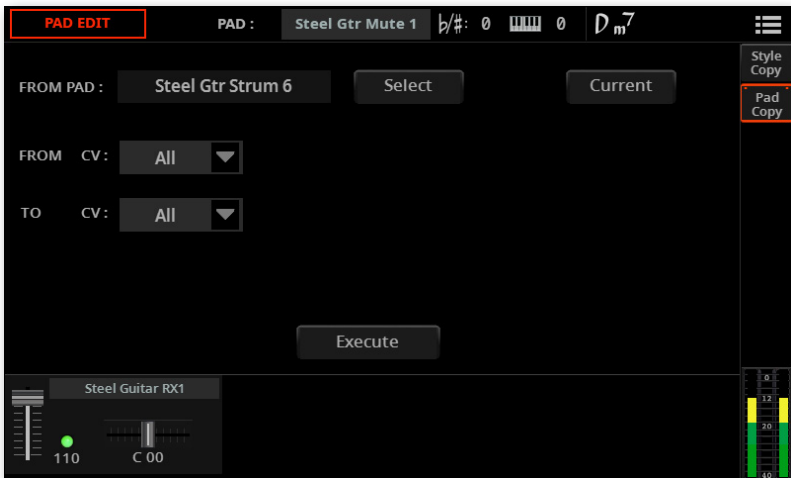

- 2 Use the **From Pad** parameter to choose the source Pad. Touch the **Select** button, and choose the source Pad.

3 There is no need to choose a source Style Element, since the Pad has only one of them. Use the **To E** pop-up menu to choose the target Style Element (E).

E (Style Element)	Meaning
All	All Elements.
Intro1 ... End3	Single Style Element.

4 There is no need to choose a source Style Element, since the Pad has only one of them. Use the **To Track** pop-up menu to choose the target one.

Track	Meaning
All	All Elements.
Bass ... Acc5	Single track of the selected Pad or Chord Variation.

5 After having set the various parameters, touch the **Execute** button. Be warned that copying will overwrite all data at the target.

When you copy over an existing Chord Variation, Program Change data is not copied, to leave the original Sounds unchanged for that Chord Variation.

Editing the MIDI events

The **Event Edit** is the page where you can edit each single MIDI event of the selected Chord Variation. You can, for example, replace a note with a different one, or change its playing strength (that is, velocity value).

The Event Edit procedure

- **Go to the Event Edit page**
- > Go to the **Style/Pad Edit > Menu > Event Edit > Event Edit** page.

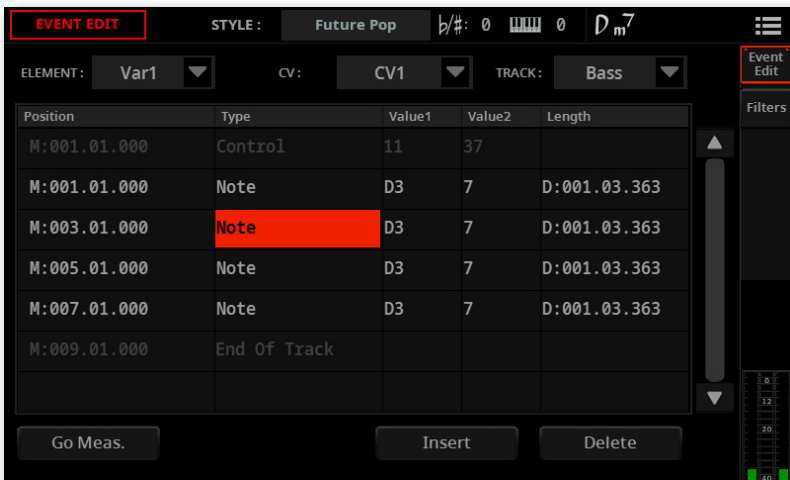

- **Choose the Style Element, Chord Variation and Track**

- 1 Press the corresponding button on the control panel to quickly choose one of the **Style Elements (INTRO 1 ... ENDING 3)**. As an alternative, use the **Element** pop-up menu. The Pad has only one of them.
- 2 Use the **CV** pop-up menu to select a Chord Variation (CV).
- 3 Use the **Track** pop-up menu to select a track. The Pad has only one of them.

■ Listen to the patterns

- > Press the **PLAY/STOP** (▶□) button and play some chords to check how it works. Press the **PLAY/STOP** (▶□) button again to stop playback.

■ Edit the events

Once you have select a Style Element, Chord Variation and Track, the list of the events contained in the selected track will appear in the display. Some events on the beginning of the Chord Variations, as well as the ‘End Of Track’ event (marking its ending point) cannot be edited, and appear dimmed.

- 1 Scroll through the various events by using the scrollbar.
- 2 Touch the event to be edited, and edit it.



- > Select the **M (Measure)**, and use the **DIAL** or **UP/DOWN** buttons to change event's position.
- > Select the **Type** parameter, and use the use the **DIAL** or **UP/DOWN** buttons to change the event type.
- > Select the **Value 1** and **Value 2** parameters, and use the use the **DIAL** or **UP/DOWN** buttons to edit them. In case of numeric values, you can also touch them twice to open the numeric keypad.
- > If a **Note** event is selected, select the **D (Duration/Length)** parameter, and use use the **DIAL** or **UP/DOWN** buttons to change the event's length.

■ Jump to a different measure

- 1 Touch the **Go Meas.** button to go to a different measure. The **Go To Measure** dialog will appear.
- 2 Enter a target measure and touch **OK** to confirm The first event available in the target measure will be selected.

■ Insert events

- > Touch the **Insert** button to insert an event at the current **Position (M)**. A Note event with default values will be inserted.

■ Delete events

- Select an event, then touch the **Delete** button to delete it.

Hiding the events from the Event Edit list

- 1 Go to the **Style/Pad Edit > Menu > Event Edit > Filters** page.

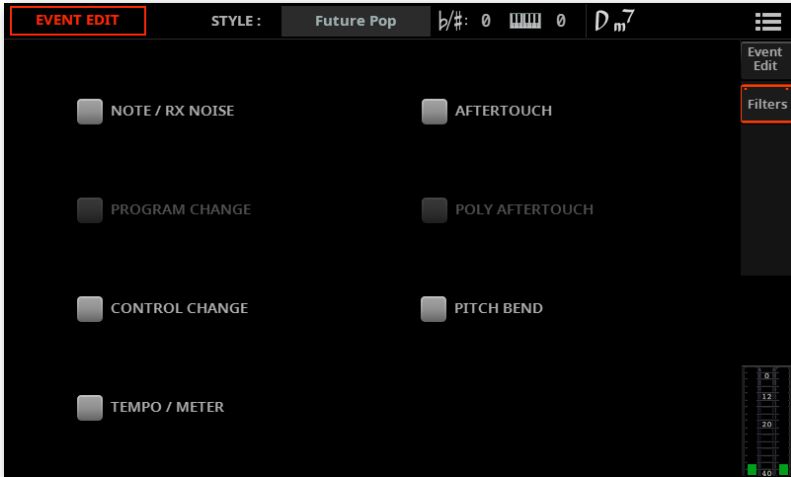

- 2 Check the event types you want to hide.

Filter	Meaning																																						
Note/RX Noise	Notes and RX Noise events.																																						
Program Change	Program Change events.																																						
Control Change	Control Change events. Only the following Control Change numbers are allowed with Styles.																																						
	<table border="1"> <thead> <tr> <th>Control function</th> <th>CC#</th> </tr> </thead> <tbody> <tr> <td>Modulation 1 (Joystick Y+)</td> <td>1</td> </tr> <tr> <td>Breath/Modulation 2 (Joystick Y-)</td> <td>2</td> </tr> <tr> <td>Pan</td> <td>10</td> </tr> <tr> <td>Expression^(a)</td> <td>11</td> </tr> <tr> <td>CC#12</td> <td>12</td> </tr> <tr> <td>CC#13</td> <td>13</td> </tr> <tr> <td>Ribbon</td> <td>16</td> </tr> <tr> <td>Damper</td> <td>64</td> </tr> <tr> <td>Filter Resonance</td> <td>71</td> </tr> <tr> <td>Release Time</td> <td>72</td> </tr> <tr> <td>Attack Time</td> <td>73</td> </tr> <tr> <td>Low Pass Filter Cutoff</td> <td>74</td> </tr> <tr> <td>Pa5X Sound Controller 1 (CC#80)</td> <td>80</td> </tr> <tr> <td>Pa5X Sound Controller 2 (CC#81)</td> <td>81</td> </tr> <tr> <td>Pa5X Sound Controller 3 (CC#82)</td> <td>82</td> </tr> <tr> <td>A/B Master FX 1 (reverb) send level</td> <td>91</td> </tr> <tr> <td>A/B Master FX 2 (modulation) send level</td> <td>93</td> </tr> <tr> <td>A/B Master FX 3 (free) send level</td> <td>94</td> </tr> </tbody> </table>	Control function	CC#	Modulation 1 (Joystick Y+)	1	Breath/Modulation 2 (Joystick Y-)	2	Pan	10	Expression ^(a)	11	CC#12	12	CC#13	13	Ribbon	16	Damper	64	Filter Resonance	71	Release Time	72	Attack Time	73	Low Pass Filter Cutoff	74	Pa5X Sound Controller 1 (CC#80)	80	Pa5X Sound Controller 2 (CC#81)	81	Pa5X Sound Controller 3 (CC#82)	82	A/B Master FX 1 (reverb) send level	91	A/B Master FX 2 (modulation) send level	93	A/B Master FX 3 (free) send level	94
Control function	CC#																																						
Modulation 1 (Joystick Y+)	1																																						
Breath/Modulation 2 (Joystick Y-)	2																																						
Pan	10																																						
Expression ^(a)	11																																						
CC#12	12																																						
CC#13	13																																						
Ribbon	16																																						
Damper	64																																						
Filter Resonance	71																																						
Release Time	72																																						
Attack Time	73																																						
Low Pass Filter Cutoff	74																																						
Pa5X Sound Controller 1 (CC#80)	80																																						
Pa5X Sound Controller 2 (CC#81)	81																																						
Pa5X Sound Controller 3 (CC#82)	82																																						
A/B Master FX 1 (reverb) send level	91																																						
A/B Master FX 2 (modulation) send level	93																																						
A/B Master FX 3 (free) send level	94																																						
	(a). Expression events cannot be inserted at the starting Position (001.01.000). An Expression value is already among the default 'header' parameters of the Style Element or Pad, and can be accessed in the Element Track Controls > Expression page.																																						
Tempo/Meter	Tempo Scaling events (Drum track only).																																						
After Touch	After Touch events.																																						
Poly After Touch	Polyphonic After Touch events.																																						
Pitch Bend	Pitch Bend events.																																						

Importing and exporting the Styles and Pads

Importing a Standard MIDI File to a Style

Preparing a Standard MIDI File ‘separated by markers’

You can convert a Standard MIDI File ‘separated by markers’ into a Style. This is a single Standard MIDI File containing all the Chord Variations and Style Elements (Variation 1, Variation 2, etc.) each one separated by a marker (the same events used in a MIDI Song).

The Standard MIDI File to be imported must be programmed as if it was a set of Pa5X’s Chord Variations. Here are the rules.

■ Style Element / Chord Variation parameters

When importing a MIDI file, parameters like CV Length, Meter, Tempo Changes and Expression are recognized. Program Changes are imported only to empty tracks.

- The **Chord Variation length** is the same as the imported MIDI file.
- **Chord, Chord Table, Expression**, and any other Style Element parameter, must be manually programmed in the relevant Style/Pad Edit pages.
- The starting **Tempo**, and each track’s **Volume**, must be programmed in the Home mode, and then saved in the new Style/Pad.
- The starting **Meter (Time Signature)** is used for the whole Style.

■ MIDI events

When importing, only the events allowed for recording are imported (as shown in the table on [page 734](#)). Some controllers are reset at the end of the pattern.

■ Note length

If a note extends beyond the last measure of the Chord Variation, an additional measure is appended (for example, if a note extends after the end of the fourth measure in a 4-measure pattern, a 5-measure Chord Variation will be generated).

■ MIDI channels

When programming a Chord Variation on an external sequencer, please assign each Style track to the correct MIDI channel (In and Out), according to the following table.

Style Track	MIDI Channel
Bass	09
Drum	10
Percussion	11
Accompaniment 1	12
Accompaniment 2	13
Accompaniment 3	14
Accompaniment 4	15
Accompaniment 5	16

The Pad track is to be assigned to MIDI channel #10.

■ Naming conventions

The naming structure for the markers inside the SMF is *'encvn'*, whose single components are shown in the following table:

Component	Meaning
e	Style Element ('v' = Variation, 'i' = Intro, 'f' = Fill, 'e' = Ending, 'br' = Break).
n	Style Element number ('1'~'4' for Variations and Fills, '1'~'3' for Intros and Endings). The Break has no number.
cv	Chord Variation ('cv' = Chord Variation – no other choices allowed).
n	Chord Variation number (1~6 for Variations, 1~2 for all the others; the Break has no Chord Variations).

It is mandatory not to use capital letters in marker names. Some examples of valid names:

- > 'i1cv2' = Intro1 - Chord Variation 2
- > 'v4cv3' = Variation 4 - Chord Variation 3

Examples of non accepted names:

- > 'V1cv2', 'v1CV2', 'intro i1cv2', 'v1cv1 chorus'

The order of the Chord Variations inside the SMF is not relevant. They can be freely placed inside the SMF.

Pads always use names of this type: 'v1cvn' (they always start with 'v1').

Below, you can find a screenshot of a test file created in Steinberg Cubase, just as an example of how a SMF separated by markers can look like. Considering analogies between actual workstations, it will not look much different in other applications like Digital Performer, Logic Pro, Pro Tools or Studio One.

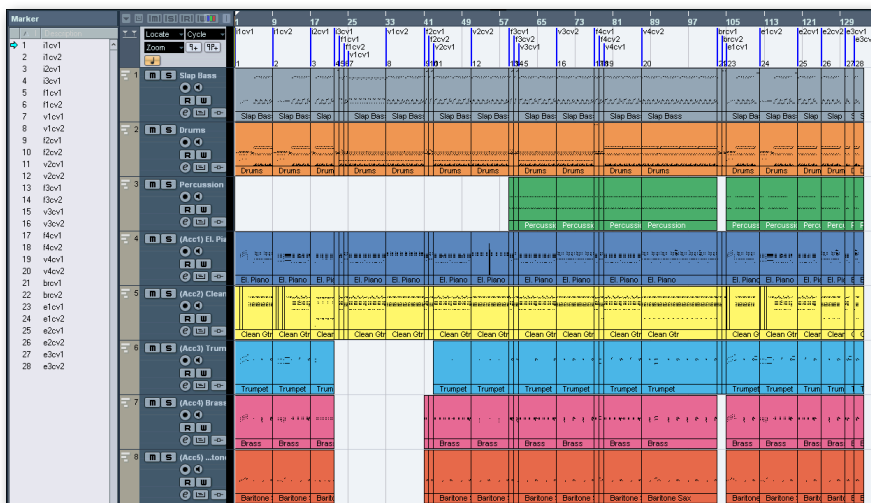

Importing a Standard MIDI File into a Style

- 1 Go to the **Style/Pad Edit > Import/Export > Import SMF** page.

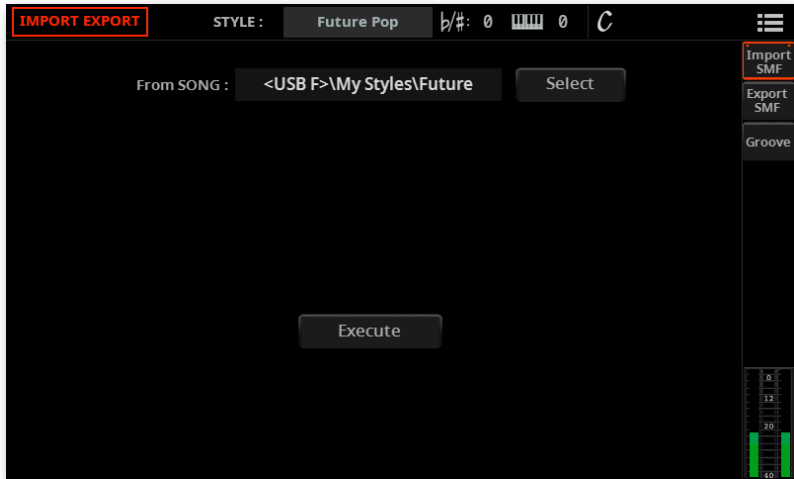

- 2 Use the **From Song** parameter to choose a MID file to import. Touch the **Select** button to open the file selector.
- 3 Touch the **Execute** button to import the Standard MIDI File.

Chord progressions for Intro 1 and Ending 1

Intro 1 and Ending 1 usually contain a chord progression. You can enter it via Text Meta Events or via Note Velocity.

■ Entering Chord progressions with the Text Meta Event

Chord progressions for Intro 1 and Ending 1 can be entered as Meta Events of type Text. The chord root is entered by typing the note name from C to B (using '#' or 'b' for accidentals). The chord type is entered using the abbreviations shown in the following table.

Chord Type		Chord Type	
Major	(leave blank)	Major 6th	6
Major 7th	M7	Major 7th flatted 5th	M7(b5)
Suspended 4th	sus	Suspended 2nd	sus2
Major 7th suspended 4th	M7sus	Minor	m
Minor 6th	m6	Minor 7th	m7
Minor 7th flatted 5th	m7(b5)	Minor major 7th	m(M7)
Dominant 7th	7	7th flatted 5th	7(b5)
7th suspended 4th	7sus	Dimished	dim
Diminished major 7th	dim(M7)	Augmented	#5
Augmented 7th	7(#5)	Augmented major 7th	M7(#5)
Major w/o 3rd	(1+5)	Major w/o 3rd and 5th	(1+8)
Flatted 5th	b5	Diminished 7th	dim7

As an example, a typical C Major progression will be entered as follows:

Chord	Meta Event content
C Major	C
A Minor 7th	A m7
D Minor	D m
G Dominant 7th	G 7

Exporting a Style

You can export a whole Style as an SMF separated by markers, that is, a single SMF containing all the Chord Variations and Style Elements (Variation 1, Variation 2, etc.) each one separated by a marker (the same events used in Song Play mode).

- 1 Go to the **Style/Pad Record > Import/Export > Export SMF** page.

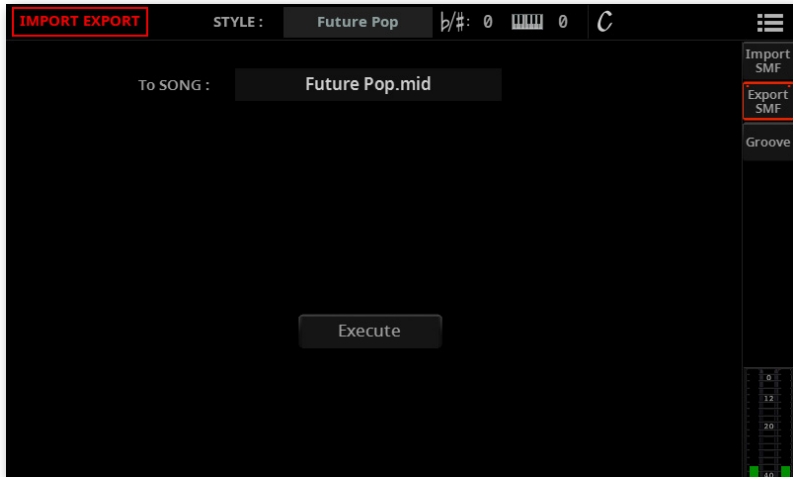

The (non editable) **To Song** parameter shows the name of the Standard MIDI File that will be automatically generated.

- 2 Touch the **Execute** button to export it as a Standard MIDI File. A standard file selector will appear. Select the target device and directory, then touch **Save**. A dialog box will appear, letting you assign a name to the file.

This operation will create, in the selected device, an SMF format 0 (Zero), containing all the MIDI data included in the selected Style or Pad, with each Chord Variation starting from a different marker (named as per the naming convention explained in the Import section above).

Saving the Style or Pad

Saving the Styles

You can save the new or edited Style as a User Style.

- **Open the Save dialog from the display**

> Choose the **Save Style** command from the **page menu** (☰).

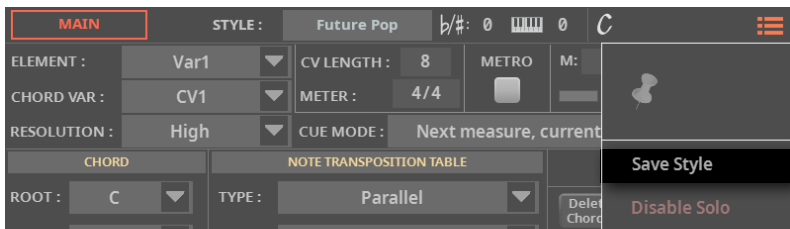

The **Save Style** dialog will appear.

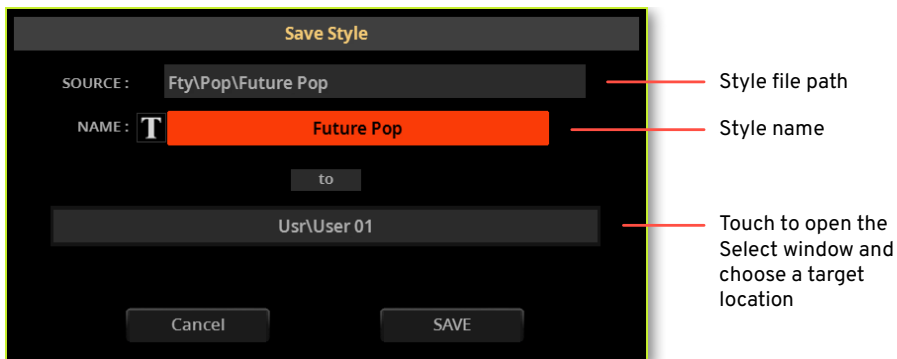

■ Save over the same User Style

- > If you want to overwrite the current User Style, just touch the **Save** button.

■ Rename the Style

While in the **Save Style** dialog, you may change the **name** of the Style.

- 1 Touch the **Text Edit (T)** button to open the **virtual keyboard** and edit the name.
- 2 When done editing the name, confirm by touching the **OK** button under the virtual keyboard.

■ Save to a different place

- 1 If you want to save to a different folder, touch the **To (target path)** button in the **Save Style** dialog, and open the **Save To** window.

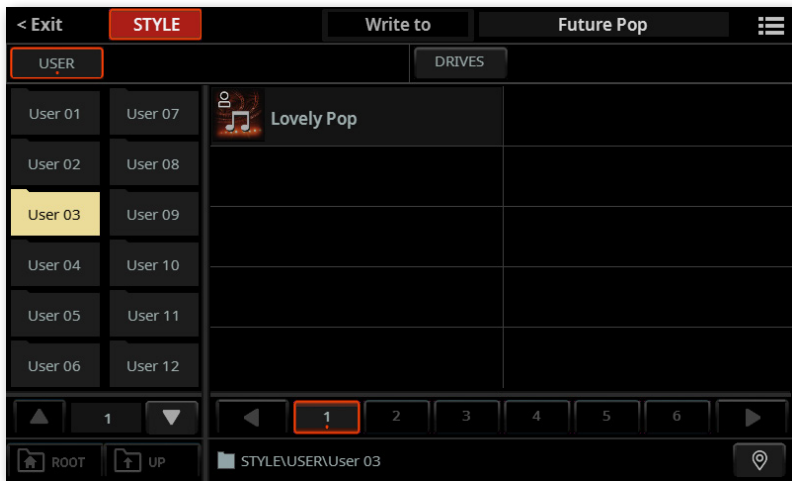

2 Touch the **folder** where you want to save the new Style.

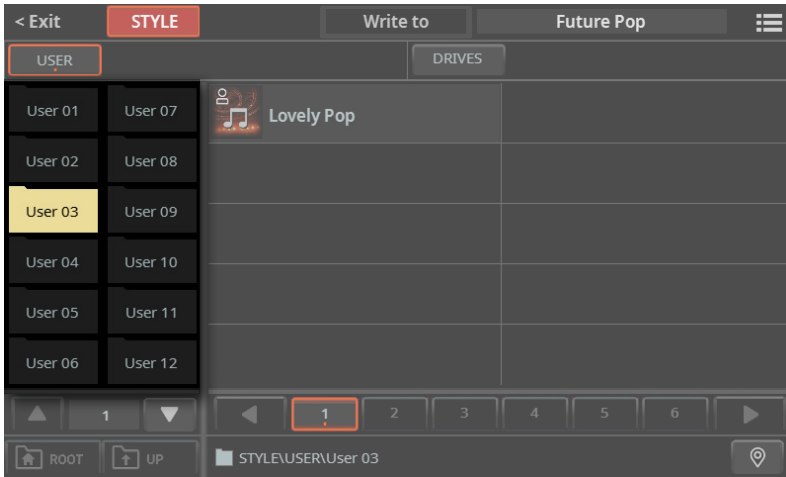

3 To save a new file, don't touch any of the Styles in the folder (shown in the right side of the window). On the contrary, if you want to overwrite one of the existing elements, touch it.

4 Press the **EXIT** button to close the **Save To** window and confirm your selection.

5 When back at the **Save Style** dialog, confirm the Save operation by touching the **Save** button.

Saving the Pads

You can save the new or edited Pad as a User Pad.

■ Open the Save dialog from the display

- > Choose the **Save Pad** command from the **page menu** (☰).

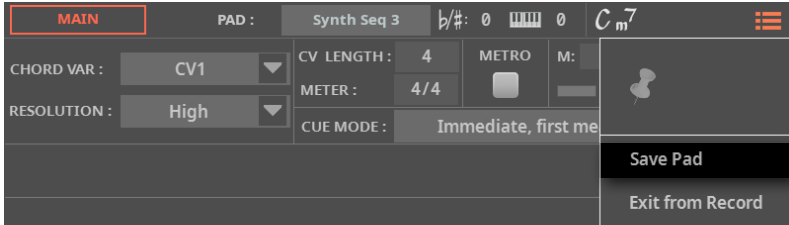

The **Save Pad** dialog will appear.

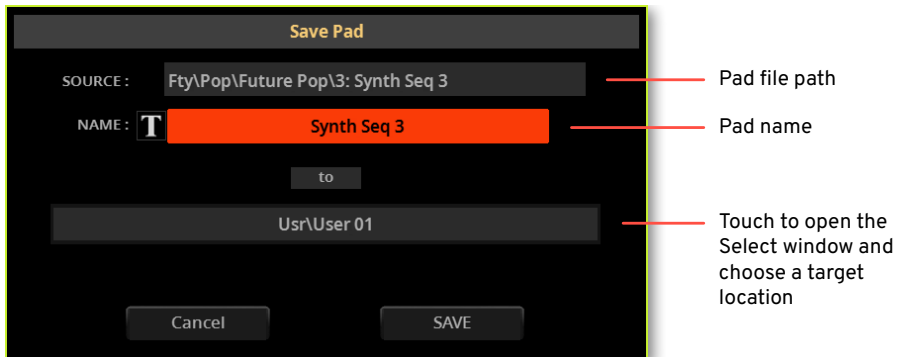

■ Save over the same User Pad

- > If you want to overwrite the current User Pad, just touch the **Save** button.

■ Rename the Pad

While in the **Save Pad** dialog, you may change the **name** of the Pad.

- 1 Touch the **Text Edit** (T) button to open the **virtual keyboard** and edit the name.
- 2 When done editing the name, confirm by touching the **OK** button under the virtual keyboard.

■ Save to a different place

1 If you want to save to a different folder, touch the **To (target path)** button in the **Save Pad** dialog, and open the **Save To** window.

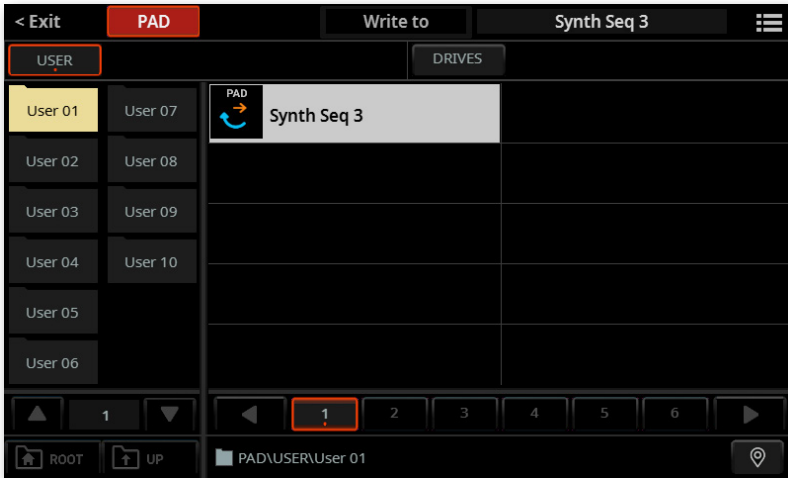

2 Touch the **folder** where you want to save the new Pad.

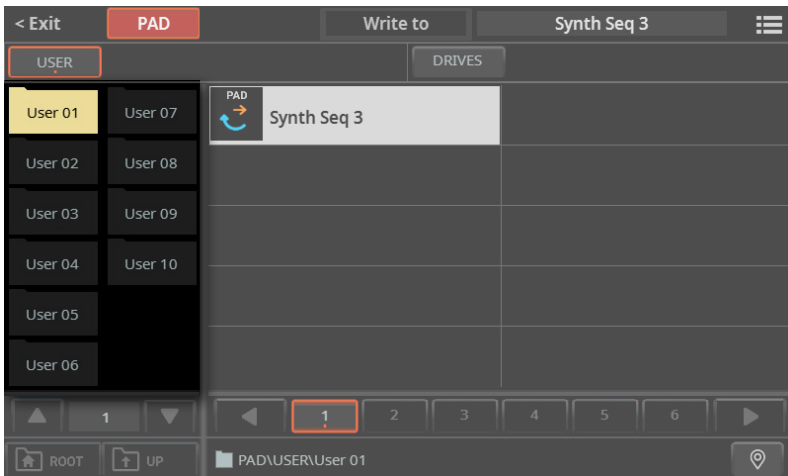

3 To save a new file, don't touch any of the Pads in the folder (shown in the right side of the window). On the contrary, if you want to overwrite one of the existing elements, touch it.

- 4 Press the **EXIT** button to close the **Save To** window and confirm your selection.
- 5 When back at the **Save Pad** dialog, confirm the Save operation by touching the **Save** button.

30

Recording the Chord Sequences

Recording Chord Sequences

You can record a Chord Sequence, that can then be saved to the dedicated library or in the selected User Style. The new Chord Sequence can then be used with any other Style.

Please note that recording a new sequence will delete the exiting one (if any).

■ Prepare recording

- 1 Go to the **Home > Main** page, and choose a Style. If you want to save the new Chord Sequence in the Style, choose a User Style (Factory Style can't be overwritten).
- 2 Go to the **Home > Chords** pane.

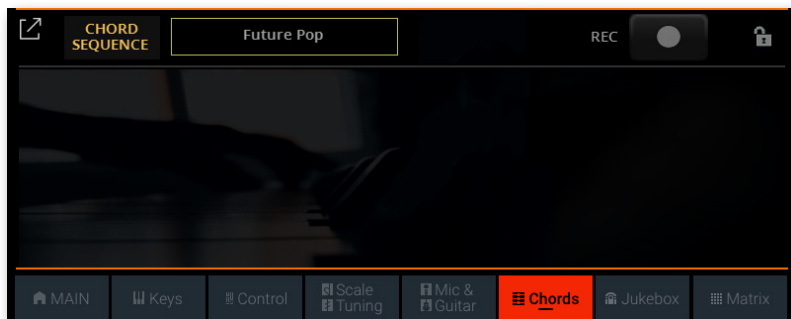

■ Start recording

- 1 Touch the **Record (●)** button in the display. The button will start flashing in red. Any sequence already selected will be deleted from memory.

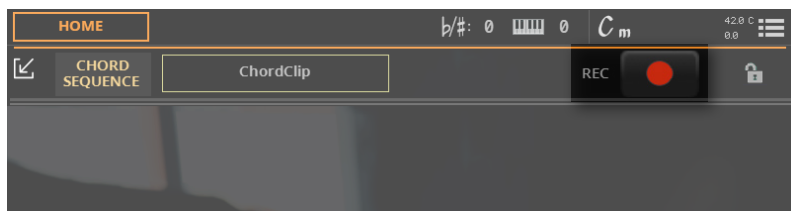

- 2 At this point, you can start recording in one of two ways:
 - > If the **SYNCHRO START** indicator is turned off, play the first chord of the sequence, and keep it held. Then press the **PLAY/STOP** (▷□) button to start recording.
 - > If the **SYNCHRO START** indicator is turned on, recording will start as soon as you play a chord.
- 3 While recording, the **Record** (●) button in the display will be steadily red. Check the recognized chords appearing in the display.

■ Stop recording

- 1 Stop recording in one of two ways:
 - > Press the **PLAY/STOP** (▷□) button on the control panel. The Style will stop. The **CHORD > SEQUENCE** indicator will become white to show that there is a Chord Sequence available.
 - > Touch the **Record** (●) button in the display. The button will go dark. The Style will continue to play. The **CHORD > SEQUENCE** indicator will become orange or blue, and the recorded Chord Sequence will play in loop.
- 2 At this point, you can use the **CHORDS > SEQUENCE** button to turn the sequence on or off.
- 3 Check if the recorded chords are correct.

■ Save the Chord Sequence

The Chord Sequence will remain in memory until you record a new Chord Sequence, choose a different Style or SongBook Entry, or turn the instrument off.

If the sequence is locked, it will not change when choosing a different Style or SongBook Entry.

To avoid losing it, save it, as described in the following pages.

Saving a Chord Sequence

You can save your Chord Sequences into the dedicated library, or as the Chord Sequences inside a User Style.

Saving Chord Sequences to the library

The library is where you organize the Chord Sequences by type and category, independently from a Style or SongBook Entry. You can recall these Chord Sequences from the **Home > Chord** page. A link to the selected Chord Sequence can then be saved with a Style or SongBook entry.

Factory Chord Sequences can't be overwritten. If you want to save changes to a Factory Chord Sequence, copy it into the User area.

Note: All changes will be lost when choosing a different Chord Sequence, unless you save them.

■ Open the Save dialog from the display

> Choose the **Save Chord Sequence (to Library)** command from the **page menu** (☰).

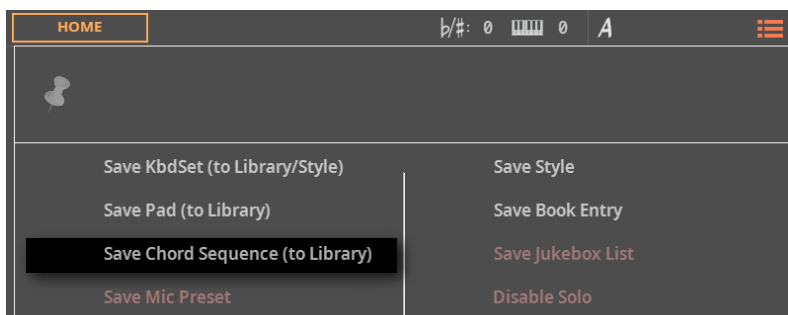

The **Save Chord Sequence** dialog will appear. If the selected Style is a **Factory** one, and you can't save on it, you will only be allowed to save into the **Chord Sequence Library**.

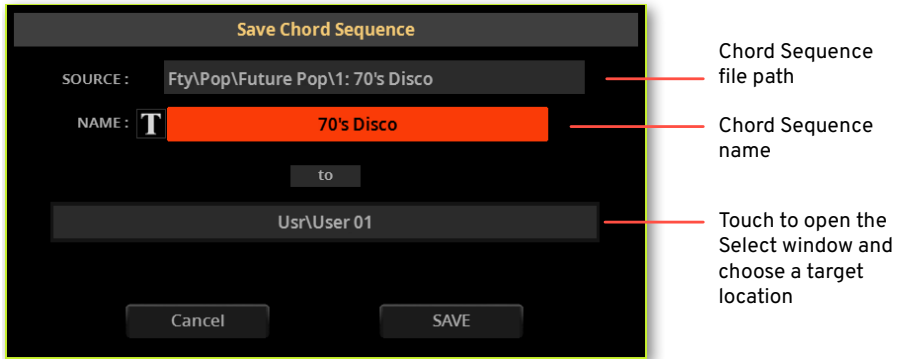

■ Save over the same User Chord Sequence

> If you want to overwrite the current User Chord Sequence, just touch the **Save** button.

■ Rename the Chord Sequence

While in the **Save Chord Sequence** dialog, you may change the **name** of the Chord Sequence.

- 1 Touch the **Text Edit** (**T**) button to open the **virtual keyboard** and edit the name.
- 2 When done editing the name, confirm by touching the **OK** button under the virtual keyboard.

■ Save to a different location

1 If you want to save to a different folder, touch the **To (target location)** button in the **Save Chord Sequence** dialog, and open the **Save To** window.

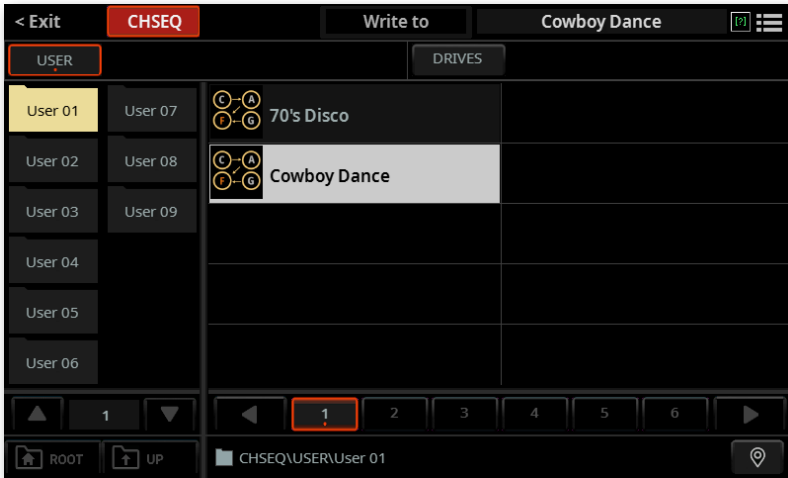

2 Touch the **folder** where you want to save the new Chord Sequence.

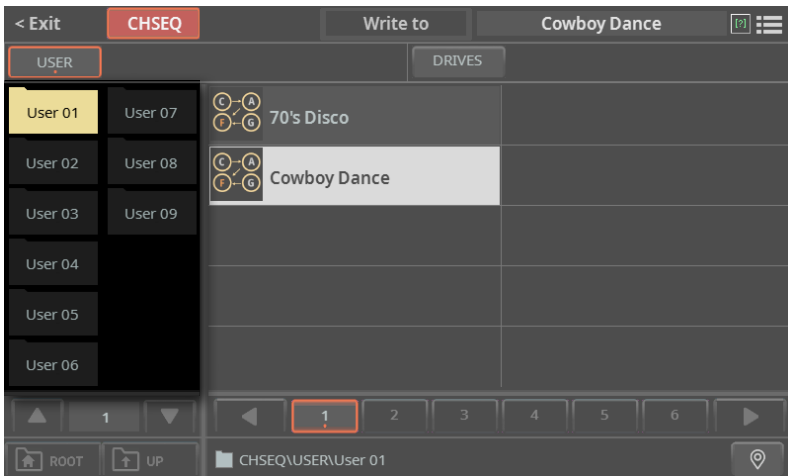

- 3 To save a new file, don't touch any of the Chord Sequences in the folder (shown in the right side of the window). On the contrary, if you want to overwrite one of the existing elements, touch it.
- 4 Press the **EXIT** button to close the **Save To** window and confirm your selection.
- 5 When back at the **Save Chord Sequence** dialog, confirm the Save operation by touching the **Save** button.

Saving Chord Sequences into a Style

Styles can contain a Chord Sequence. When choosing a Style, a Chord Sequence working well with the selected Style is automatically selected.

You can save a new Chord Sequence into a User Style. Factory Styles can't be overwritten. If you want to edit and save a Factory Style, copy it into the User area.

- 1 Choose the **Save Style** command from the **page menu** (☰).

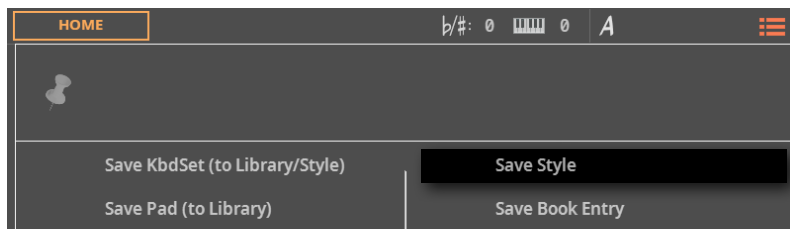

- 2 Confirm saving.

31

Editing the Sounds

Editing Sounds

Creating your own Sounds

You can edit each single parameter of a Sound. Pa5X is, at its core, a powerful sample-based synthesizer, with advanced analogue-like sound shaping features.

Sound generation

At the base of each Sound there are Samples, that are recordings of real sounds.

Each Sample is assigned to a separate zone of the keyboard together with other Samples to create a Multisample. One or two Multisamples are assigned to each Oscillator.

Up to twenty-four stereo Oscillators can be put together to make a Sound. In a Sound, Oscillators are balanced, layered, and processed by the Effects.

Sounds are the basic unit of the Pa5X's timbre, and can be combined in combinations called Keyboard Sets. They can also be individually assigned to Style, Pads and MIDI Song tracks.

Sounds, Drum Kits, Digital Drawbars

Pa5X features different types of Sounds:

- > Ordinary Sounds. These are normal instrument Sounds, like pianos, strings, basses.
- > Drum Kits. These are drum and percussion kits, where each note (key) of the keyboard is a different percussive instrument.
- > Digital Drawbars. These are Sounds simulating electromechanical organs. Their complex structure, and the special usage, require their settings to be saved into a Keyboard Set. They are explained in a dedicated chapter.

Before pressing the **MENU** button to access the edit pages, you should select a Sound of the type you wish to edit or create.

Accessing the Sound Edit mode

You can edit and save the User Sounds. Factory Sounds are protected. If you access editing with a Factory Sound, a temporary copy is automatically created in memory.

- 1 Press the **REC/EDIT** button on the control panel to see the **Record/Edit** menu.

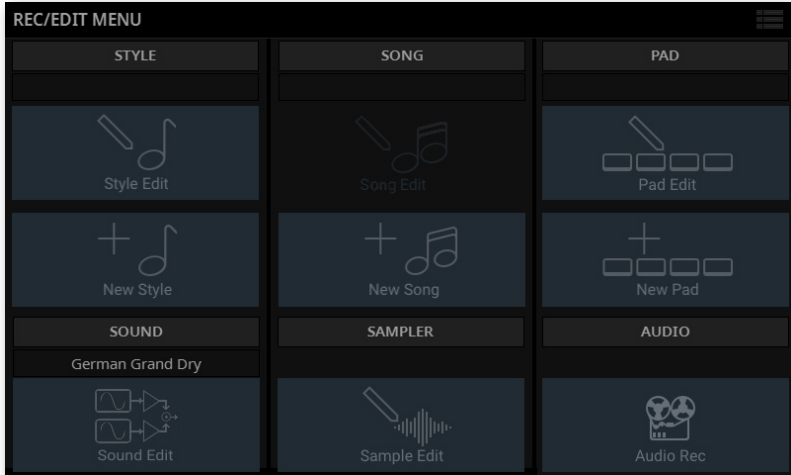

2 Touch the **Sound Edit** button in the menu. The **main page** of the **Sound Edit** mode will appear.

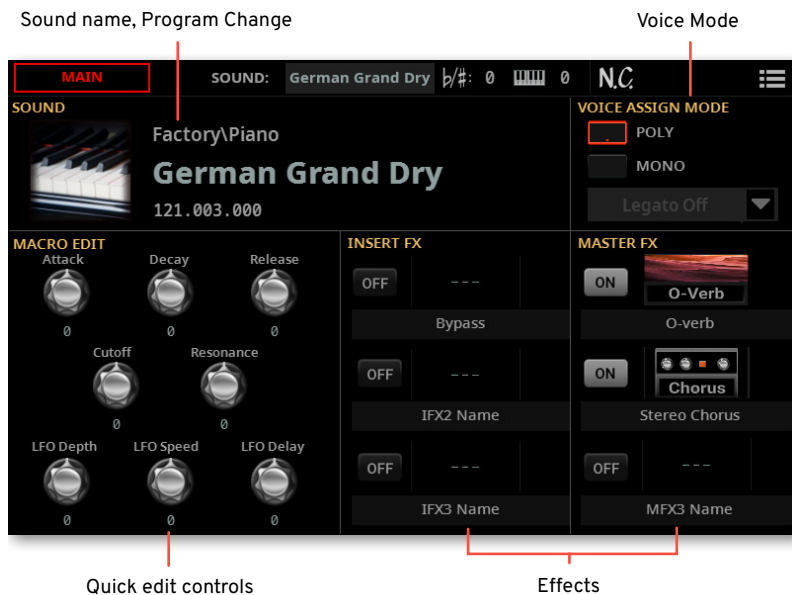

- 3 Press the **MENU** button on the control panel, and touch one of the buttons to choose the corresponding **edit section** of the **Sound Edit** mode.

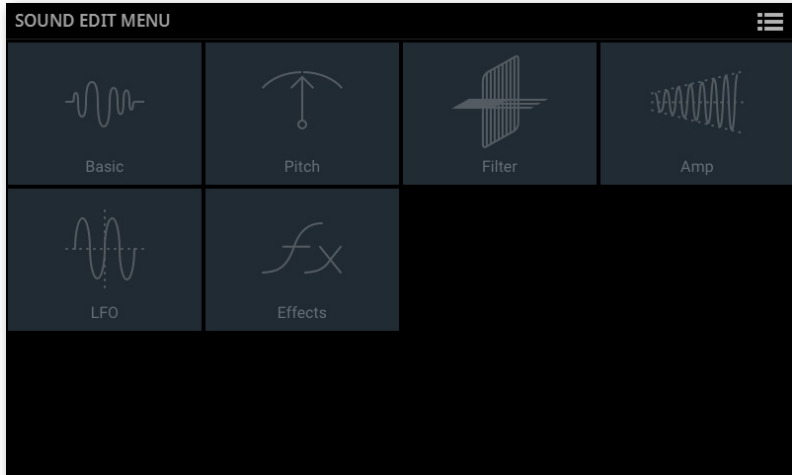

Sound Edit Menu page with an ordinary Sound selected

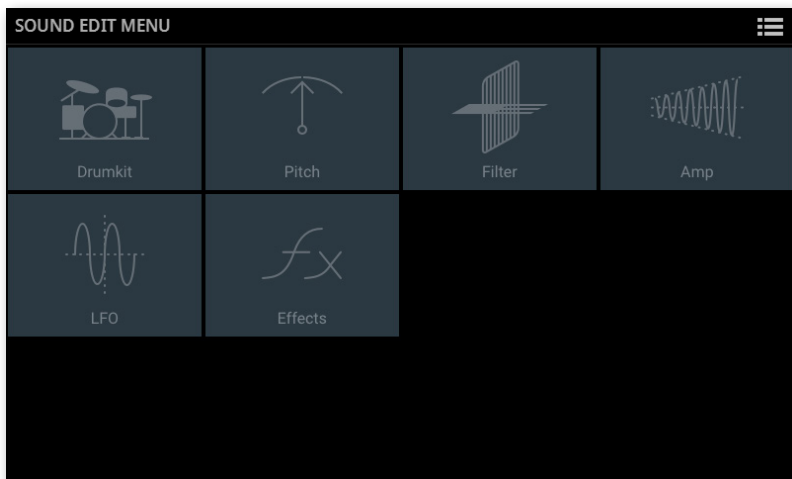

Sound Edit Menu page with a Drum Kit selected

- 4 Press the **EXIT** button on the control panel to return to the **main page** of the **Sound Edit** mode.

Saving the Sound

When finished editing the Sound parameters in the **main page** of the **Sound** mode, choose the **Save Sound** command from the **page menu** (☰) to save the Sound. More details on saving Sounds are at the end of this section.

Exiting the Sound Edit mode

To exit from the **Sound Edit** mode, press the **EXIT** or the **REC/EDIT** button again. In case the Sound has not been saved, it will in memory until you turn the instrument off. You can continue editing later.

Listening to the individual Sounds

While in the **Sound Edit** mode, the selected Sound can always play across the full keyboard range. The split point will be ignored.

Choosing a Sound

1 While in the **main page** of the **Sound** mode, touch the **name of the Sound** to open the **Sound Selection** window.

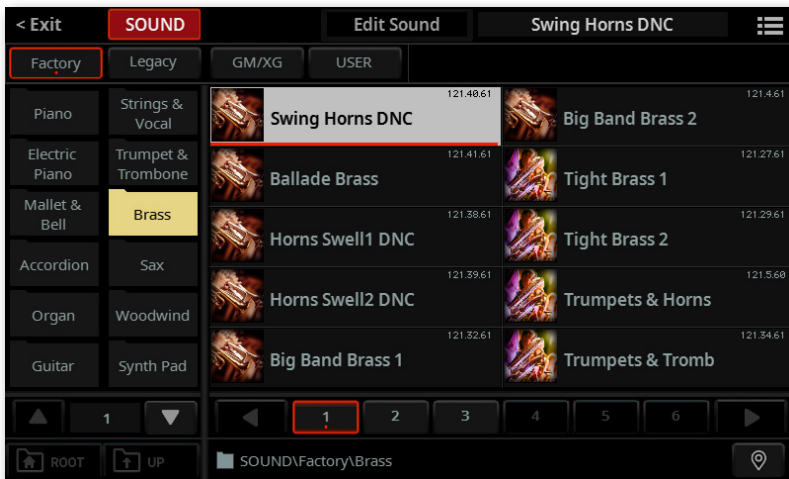

2 Browse through the Sounds, and touch the Sound you want to select.

Playing via MIDI

In **Sound Edit** mode, Pa5X receives and transmits on the same channel as the Upper 1 part. If the Global channel is assigned to a MIDI channel, notes can also be received on this channel.

MIDI channels can be programmed in the **Settings > Menu > MIDI > MIDI IN Channels** page.

Customizing the Sounds

While in the **main page** of the **Sound Edit** mode, you can edit the main parameters of the Sound, using 'macro' commands adding an offset to the actual parameters.

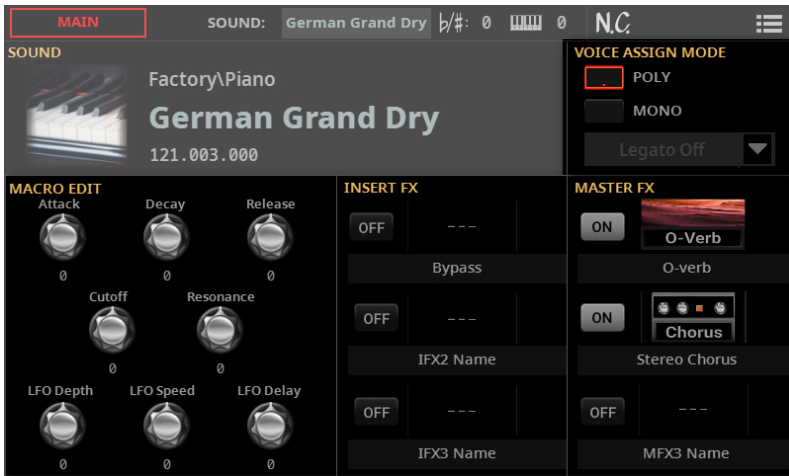

Using the Macro Edit controls

- > Use the **Macro Edit** controls to edit the main parameters of the Sound.

All values are an offset of the original values memorized in the Sound (they are added to or subtracted from the original values). The position of these controls is reset after you save the Sound, or choose a different Sound.

Realtime Control	Meaning
Attack	Attack time. This is the time during which the sound goes from the Start level (at the moment when you press a key) to the Attack level.
Decay	Decay time. Time to go from the final Attack level to the beginning of the Sustain.
Release	Release time. This is the time during which the sound goes from the sustaining phase, to zero. The Release is triggered by releasing a key.

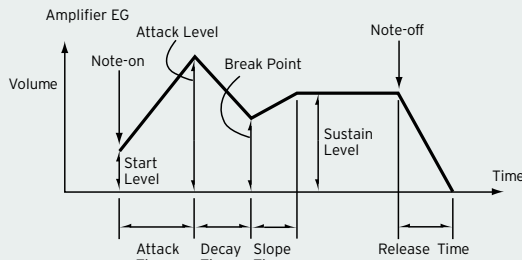

Cutoff Filter cutoff. This sets the sound brightness.

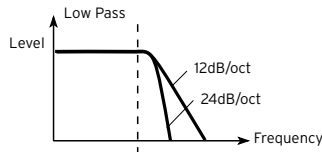

Resonance	Use the Filter Resonance to boost the part of the sound spectrum around the cutoff frequency.
LFO Depth	Intensity of the Vibrato (LFO).
LFO Speed	Speed of the Vibrato (LFO).
LFO Delay	Delay time before the Vibrato (LFO) begins, after the sound starts.

Setting the Voice Assign mode

Voice Assign mode is where you choose whether the Sound will play in poly or mono mode, and how legato will work in mono mode.

- > Use the **Poly** and **Mono** radio buttons to choose whether the Sound will play polyphonically (chords allowed) or monophonically (only melodies, one voice at a time).
- > When **Mono** mode is selected, use the **Legato** pop-up menu to choose the type of legato.

Legato	Meaning
Legato Off	Legato phrasing will produce the same sound as detached playing.
Legato	Legato will make the second note's attack smoother. Envelope and LFO will not be retriggered. This is particularly effective analog synth-type sounds.
Legato Offset	When you play legato, the second and subsequent notes will restart without playing the attack part of the sample. This is particularly effective with real sounds, like wind instruments. The resulting effect depends on the selected multisample.

Choosing the effects

Sounds are sent to three **Insert Effect** processors (**IFX 1-3**) and three **Master Effect** processor (**MFX 1-3**).

The recommended Insert FXs depend on the Sound, and they might even not be assigned. An acoustic piano, for example, usually don't require them.

Master FX can be freely assigned. The first one is usually a reverb, the second a modulating effect, the third one anything that can be useful for the sound.

- > Use the **On/Off** switch to turn on or off the corresponding effect.
- > Touch the **name of the effect** to open its editing window.
- > Touch the **name of the effect** to choose a different one.

Full editing of the Sounds

Choosing the oscillators (OSC)

While in a page asking for an oscillator to be selected for editing, use the row of buttons at the bottom of the page to select one of the available oscillators. The number of available oscillators depends on the Oscillators Count parameter (in the **Sound Edit > Basic > Sound** page).



When oscillators cannot be select, since the parameters contained in the current page are global and valid for the full Sound, these buttons are dimmed, and cannot be selected.

Setting the Sound's basic parameters

Before editing the oscillators, choose the number of oscillators in the Sound, the Sound's mono/poly mode, and the transpose and legato ranges.

- Go to the **Sound Edit > Menu > Basic > Sound** page.

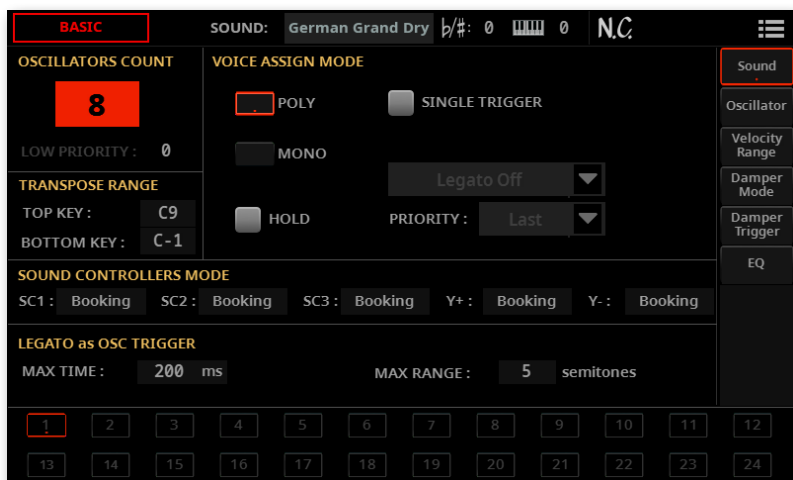

Setting the number of oscillators

The **Oscillators Count** section is where you choose how many voices will be used by a single Sound.

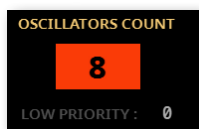

■ Choosing the number of oscillators

- Use the **Oscillators Count** parameter to choose the number of oscillators (up to 24) the Sound is based on.

The total polyphony varies depending on the number of oscillators used by the Sound (a maximum of 160 with only 1 oscillator per voice).

■ Limiting the number of oscillators when polyphony is low

> Use the **Low Priority** parameter to allow the higher-numbered oscillators to be turned off when the instrument is short on voices. Keep in mind that, with a dense polyphony, missing oscillators might not even be heard.

Low Priority	Meaning
0	No oscillator will be turned off in any case.
1	The highest-numbered oscillator will be turned off, if needed.
2	The two highest-numbered oscillators can be turned off, one after the other, if needed.
[n]...24	The n-numbered oscillators (up to 24) can be turned off, one after the other, if needed.

Limiting transposition to a defined key range

You can make some parts of the Sound, for example in a keyboard range containing special effects that shouldn't be transposed, fall out of the **Transpose Range**.

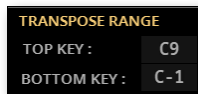

> Use the **Transpose Range (Top Key and Bottom Key)** parameters to limit transposition to a defined key range. Notes will only be transposed if falling inside this range.

This is useful to avoid RX Sounds to be transposed (therefore reassigned to different sounds) when transposing a Sound. Set these values so that all RX Noises assigned to any oscillator will fall out of the Transpose Range. For example, if you assigned an RX Noise to a G7 on OSC1, and an RX Noise to an A7 on OSC2, set the Top Key value no higher than F#7 (just below the lowest RX Noise).

Polyphony, triggering, legato

The **Voice Assign Mode** section is where you choose polyphony, triggering and legato.



■ Choosing the mono/poly mode

> Use the **Poly** and **Mono** radio buttons to choose whether the Sound will play polyphonically (chords allowed) or monophonically (only melodies, one voice at a time).

■ Choosing retriggering mode

> When the selected mode is **Poly**, use the **Single Trigger** checkbox to choose the triggering mode.

Single Trigger	Meaning
On	When the same note is played repeatedly, the previous note will be silenced before the next note is sounded, so that the notes do not overlap.
Off	When the same note is played repeatedly, the previous note will not be silenced before the next note is sounded.

■ Activating Legato

- > When the selected mode is **Mono**, use the **Legato** pop-up menu to choose the type of legato.

Legato	Meaning
Legato Off	Legato phrasing will produce the same sound as detached playing.
Legato	Legato will make the second note's attack smoother. Envelope and LFO will not be retriggered. This is particularly effective analog synth-type sounds.
Legato Offset	When you play legato, the second and subsequent notes will restart without playing the attack part of the sample. This is particularly effective with real sounds, like wind instruments. The resulting effect depends on the selected multisample.

■ Choosing the Mono note priority

- > When the selected mode is **Mono**, use the **Priority** pop-up menu to specify which note will be given priority when two or more notes are played simultaneously.

Priority	Meaning
Low	The lowest note will take priority.
High	The highest note will take priority.
Last	The last note will take priority.

■ Holding notes

- > Select the **Hold** checkbox to let the notes play even after releasing the keys. This is especially useful for percussive sounds, that you will trigger and let alone sounding.

Setting the Sound Controllers Mode

You can use the assignable switches, footswitch, Control button and the joystick as DNC Sound Controllers. Depending on the Sound, these controllers can ‘book’ or ‘toggle’ a DNC function.

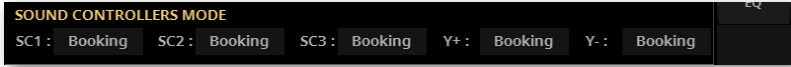

You can program the following controllers:

Sound Controller	Meaning
SC1-3	Three functions that can be assigned to an assignable switch, footswitch, or Control button.
Y-	Backward joystick movement (pull).
Y+	Forward joystick movement (push).

The controllers can work in two ways:

Sound Controller Mode	Meaning
Booking	Activate the controller to ‘book’ its function, then play. The controller will be automatically deactivated.
Toggle	Use the controller to ‘toggle’ its function between activated and deactivated.

The assigned controller type and status is shown by the indicators on the assignable switches.

Indicator status	Meaning
Off	No DNC function assigned.
Purple steady	Booking DNC function available.
Purple blinking	Booking DNC function waiting to be executed. Then, it will return steady.
Light green steady	Toggle DNC function available.
Light green blinking	Toggle activated. Press it again to disable it.

Detecting Legato

Two notes can be considered legato when there is very little or no time between them (and they can even be overlapping). You can adjust the instrument's sensitivity to detect legato.

Legato can be used to trigger an oscillator, by assigning one of the **Legato** triggers to the **Trigger Mode** parameter (in the **Sound Edit > Basic > Oscillator** page).

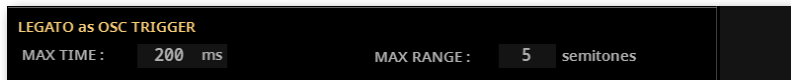

■ Adjusting the time gap

> Use the **Max Time** parameter to set the delay between notes (1...999 ms), to consider them legato, even if there is a very small gap before them.

This is useful to avoid some notes in a chord are played legato, and some others non-legato. Notes played with a small gap are still considered legato notes. A value of approx. 15 ms is usually considered effective when playing chords.

■ Adjusting the legato key range

> Use the **Max Range** parameter to set the range (1...127 semitones) within which notes can be considered legato. If you play a wider interval, the notes are always considered non-legato.

This is typical of some acoustic instruments, where legato is only possible within a small interval, but not on wider ones.

As an example, please try the 'Trumpet 2 DN1' sound, where the Max Range is 5 semitones. Play legato with intervals smaller than 5 semitones, and you will hear how smoother legato notes will become. Play legato with wider intervals, and legato smoothing will be lost.

Setting the oscillator's basic parameters

Each of the oscillators can play one or two different stereo multisamples (High and Low layers), separated by a velocity switch.

- Go to the **Sound Edit > Menu > Basic > Oscillator** page.

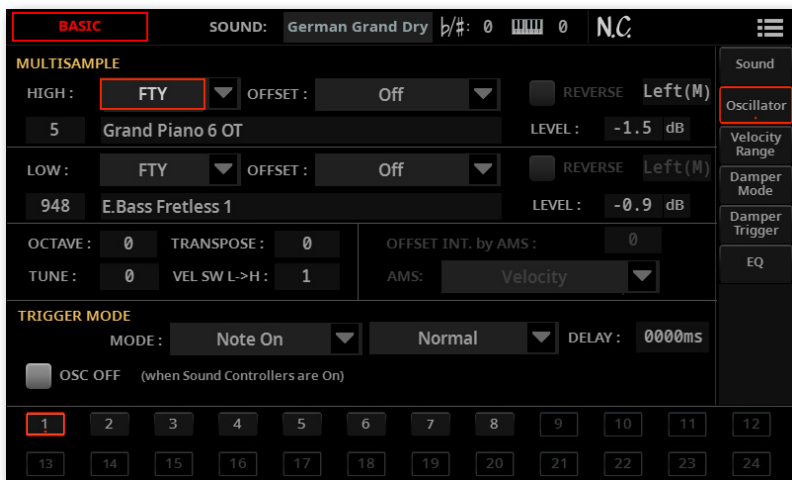

The multisamples

The **Multisample** section contains the basic parameters of the assigned multisamples.

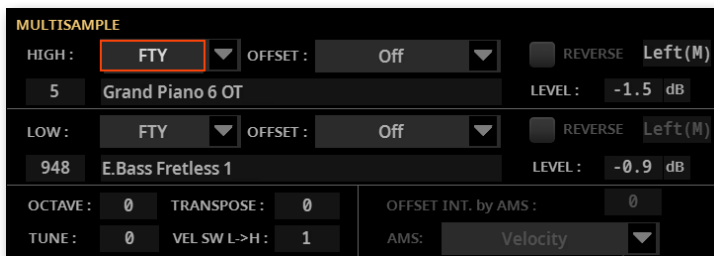

■ Choosing and setting the multisamples

- > Use the **High** and **Low** pop-up menus to choose the multisample's bank (Factory or User).
- > Use the **numeric field** next to the **multisample name** to choose the multisample inside the selected bank.

Bank	Meaning
FTY	Factory multisamples, supplied by KORG as standard.
USR	User multisamples, loaded when loading some User Sounds.

The High multisample will be triggered by velocities equal or higher than the **Vel SW L→H** value. If you do not want to use velocity switching, set the switch to a value of 1, and only assign the High multisample.

If you create a new Sound based on User samples, the User samples must be loaded from an internal or external drive. In case samples are not loaded, no sound will be heard, even if the Sound or multisample can be selected and its name appears in the display.

- > Use the **Offset** parameters to specify the point where the multisample(s) will start to play. With some multisamples this parameter is not available.

Offset	Meaning
Off	The sound will start from the beginning of the multisample waveform.
1st...6th	The sound will begin from the offset location predetermined for each sample.
No Attack	The initial portion of the multisample is ignored.
AMS	Activates the Alternate Modulation Source (see below).
Pseudo Random	(Only works when more than a single Offset point is available in the multisample). Randomly selects one of the available Offset points.

- > Select the **Reverse** checkbox to reverse the samples in the multisample (reading starts from the end). This can only be activated on some multisamples.
- > Use the **Stereo/Mono** parameter to select the stereo mode or one of the mono channels.
- > Use the **Level** parameters to specify the volume level of each multisample.

Depending on the multisample, high settings of this parameter may cause the sound to distort when a chord is played. If this occurs, lower the level.

■ Setting octave and fine tuning

- > Use the **Octave** parameter to adjust the pitch of the selected oscillator in octave units (-2...+1). The normal octave is 0 (Zero).
- > Use the **Transpose** parameter to adjust the pitch of the selected oscillator over a range of ± 1 octave (-12...+12 semitones).
- > Use the **Tune** parameter to adjust the pitch of the sample over a range of ± 1 octave (-1200...+1200 cents of a semitone).

■ Setting the velocity switch between the Low and High layers

- > Use the **Vel SW L->H** parameter to set the velocity value dividing the High and Low multisamples for the selected oscillator. Notes struck at this value or harder will be played by the High multisample. A value of 1 makes only the High multisample play.

■ Choosing an AMS (Alternate Modulation Source)

When the **AMS** option is assigned to the **Offset** parameter, the **Offset Intensity by AMS** and **AMS** parameters become available. A list of AMS sources can be found at the end of this chapter.

When the **Offset Intensity by AMS** parameter has a positive value, the selected Offset point will depend by the AMS value. For example, with the Velocity AMS, playing softly will select the Off or 1st Offset, while playing loudly will select the 6th or No Attack Offset.

When the **Offset Intensity by AMS** parameter has a negative value, the selection will happen in reverse (higher-numbered Offsets will be selected before the lowest-numbered ones).

Oscillator triggering

Triggering Mode is how the oscillator will start after pressing a key or a controller.

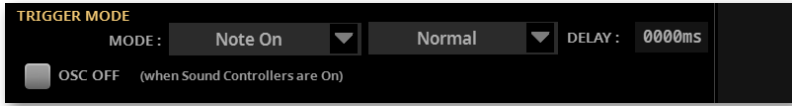

■ Choosing the oscillator triggering mode

> Use the first **Trigger Mode > Mode** pop-up menu to choose the event triggering the selected oscillator.

Trigger Mode (What)	Meaning
Note On	The oscillator starts playing when a note is played.
Note Off (VOn)	The oscillator starts playing when a note is released. Note On Velocity is considered. This is useful to create sounds such as the 'click' that is heard when a harpsichord note is released. In this case, set the Sustain parameter to 0 (see the Amp > Amp EG page).
Note Off (VOff)	As the above, but Note Off Velocity is not considered.
Last Note Off (VOn)	The oscillator starts playing only when the last note of a chord or legato sequence is released. Note On Velocity is considered.
Last Note Off (VOff)	As the above, but Note Off Velocity is not considered.
Natural Release	The oscillator starts playing when a note is released. Its amplitude starts from the current amplitude level. If the sound's volume is already at zero, this oscillator is not retriggered.
After Touch	The oscillator starts playing when an After Touch message with a value of at least 90 is received. The Velocity value is the same as the latest Note On message. The oscillator will stop playing when the After Touch value falls back to zero. Hint: This (like the following Triggers) is especially useful to trigger harmonics or growls when a note is already playing.
Joystick Y+	As the above, but with the joystick, assigned as the Sound Controller, pushed at least half-way forward (value 64). This control is equivalent to a CC#01 (Modulation) Control Change message.
Joystick Y-	As the above, but with the joystick, assigned as the Sound Controller, pulled at least half-way back (value 64). This control is equivalent to a CC#02 (Breath Controller) Control Change message.

- > Use the second **Trigger Mode > Mode** pop-up menu to choose an additional condition before triggering the selected oscillator. For example, a Normal-triggered oscillator will always play, while a Legato-triggered oscillator will only play when a note is played legato.

Trigger Mode (How)	Meaning
Normal	The oscillator always plays when a key, or another triggering control chosen in the first menu, is pressed.
Legato	The oscillator only plays when the note is played 'legato'. The delay and pitch interval from the previous note are also to be considered, as set in the Sound Edit > Basic > Sound page (Legato as OSC Trigger parameter).
Legato Up	Like Legato, but this is only activated when the second note is out of the Max Range value (as set in the Sound Edit > Basic > Sound page) and it is higher than the first one.
Legato Down	Like Legato, but this is only activated when the second note is out of the "Max Range" value (as set in the Sound Edit > Basic > Sound page) and it is lower than the first one.
Not Legato	The oscillator only plays when the note is NOT played legato (it is the opposite of the above choice). This only works if at least an oscillator is set to Legato; if there isn't, this behaves as a Normal trigger.
Sound Controller 1	<p>The oscillator only plays when a CC#80 (Sound Controller 1) message is received. Press and release the corresponding physical controller, and the next note will also trigger the selected oscillator. If you keep it pressed, the oscillator will continue to be triggered until you release the controller.</p> <p>Note: In Sound Edit mode, the Assignable Switch 1 is automatically assigned to Sound Controller 1.</p> <p>Hint: This (like the following Sound Controllers) is especially useful to enable a different nuance to the following note(s).</p>
Sound Controller 2	<p>As the above, but with the CC#81 (Sound Controller 2) message.</p> <p>Note: In Sound Edit mode, the Assignable Switch 2 is automatically assigned to Sound Controller 2.</p>
Sound Controller 3	<p>As the above, but with the CC#82 (Sound Controller 3) message.</p> <p>Note: In Sound Edit mode, the Assignable Switch 3 is automatically assigned to Sound Controller 3.</p>
Sound Controller Y+	As the above, but with the joystick, assigned as the Sound Controller, pushed at least half-way forward (value 64). The controller is turned off when the joystick is released. This control is equivalent to a CC#01 (Modulation) Control Change message.
Sound Controller Y-	As the above, but with the joystick, assigned as the Sound Controller, pulled at least half-way back (value 64). The controller is turned off when the joystick is released. This control is equivalent to a CC#02 (Breath Controller) Control Change message.

Trigger Mode (How)	Meaning
Cycle 1	All oscillators with this same trigger mode assigned will play in cycle. For example, if Oscillators 1, 2 and 4 are assigned the Cycle 1 trigger mode, the following note will trigger Oscillator 1, then 2, then 4, then 1 again. Hint: This is especially useful to trigger different sound nuances or create vector-like sound sequences.
Cycle 2	As the above, for use with a different (and parallel) group of oscillators. Having two Cycle Trigger Modes allows for cycling stereo multisamples.
Random	As the above, but with a random selection of oscillators within the assigned group.

■ Choosing a delay before note start

- > Use the **Delay** parameter to set a lapse (0...5000ms) between pressing a key (or in general triggering the oscillator) and hearing the beginning of the sound.

■ Reversing the controllers

- > Select the **OSC Off (when Sound Controllers are On)** checkbox to reverse the way Sound Controllers work. With this parameter checked, the current oscillator will not play when one of the Sound Controllers (Sound Controller 1, Sound Controller 2, Sound Controller 3, Sound Controller Y+, Sound Controller Y-) is activated.

It should be applied to oscillators with the After Touch, Joystick Y+, Joystick Y-, Normal, Legato, Legato Up, Legato Down, Not Legato, Cycle 1, Cycle 2, and Random trigger modes, that can be turned off by using a switch, footswitch or the joystick programmed as a Sound Controller.

Setting the velocity and key zone

You can limit the selected oscillator to play inside a defined velocity zone and key range. This will allow for creating different key and velocity layers.

- > Go to the **Sound Edit > Menu > Basic > Velocity/Range** page.

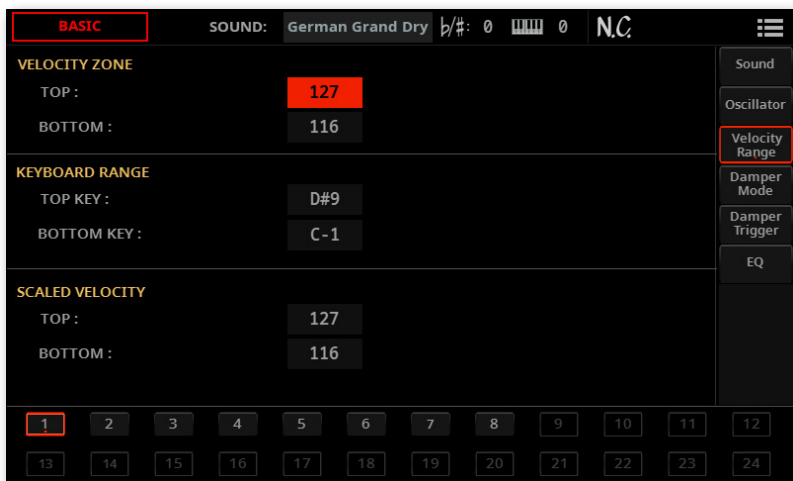

■ Setting a velocity zone

- > Use the **Velocity Zone (Top and Bottom)** parameters (0...127) to specify the velocity zone for the selected oscillator.

■ Setting a key range

- > Use the **Keyboard Range (Top Key and Bottom Key)** parameters (C-1...G9) to specify the note range for the selected oscillator.

■ Scaling the received velocity values

- > Use the **Scaled Velocity (Top and Bottom)** parameters (0...127) to scale the velocity values received by the oscillator. By using the Velocity Zone, an oscillator may be limited to a restricted range (say, 10 to 20), that may result in weak dynamics when the associated sample is triggered.

By assigning a different value to these parameters, the restricted range will be expanded to a wider range (for example, the lowest range value of 10 may be converted to a Scaled Velocity value of 0, and the highest range value of 20 may

be converted to a Scaled Velocity value of 127). All values included between the minimum and maximum value are scaled accordingly.

As a consequence, you can create an RX Sound of guitar, by assigning the guitar fret noise to the 10~20 velocity range. When a dynamics value between 10~20 is received, the real velocity value is scaled to the Scaled Velocity values, and will play louder.

Programming the Damper pedal

Programming the pedal

Pa5X carefully recreates the way an acoustic piano Damper pedal works.

- > Go to the **Sound Edit > Menu > Basic > Damper Mode** page.

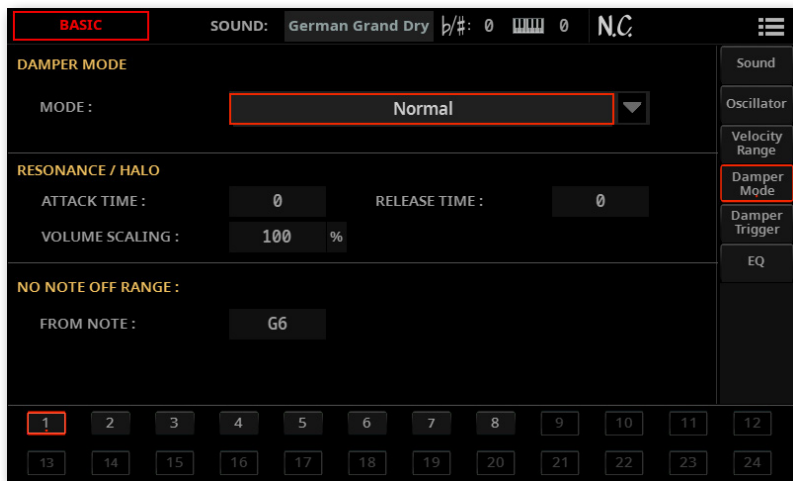

■ Choosing a Damper pedal mode

- > Use the **Damper Mode** pop-up menu to choose how the Damper pedal will work on the selected oscillator.

Damper Mode	Meaning
Normal	The Damper pedal works as usual: by keeping it pressed, the note decay is lengthened, to simulate the longer note decay of an acoustic piano.
Damper Off	The Damper pedal is deactivated for the selected oscillator. Choose Damper Off, if you plan to use the selected oscillator in the Basic > Damper Trigger page to trigger sounds.

Damper Mode	Meaning
Resonance/Halo	<p>The Damper pedal enables a multisample, normally used for the Piano Resonance/Halo effect. If the pedal is pressed when the note is already playing, the speed at which the multisample appears and disappears, and the volume it can reach, depend on the Resonance/Halo parameters programmed below.</p> <p>Hint: This Damper mode is much more realistic than the Normal mode, but also 'steals' more notes from the overall polyphony, and is especially suggested for solo piano playing.</p> <p>Note: Half-pedaling, as well as Damper messages received via MIDI (as Control Change #64), control the level of the Resonance/Halo effect.</p>
Repedaling	<p>This mode acts as the Normal mode, but also enables the Damper pedal effect when the pedal is pressed after the note has been released (Note Off). In this case, the Damper effect starts from the current Release level, and decays slowly.</p> <p>Do not use Repedaling in Sounds used by Style tracks.</p>

■ Programming the Resonance/Halo

You can program the Resonance/Halo effect that is enabled by the **Resonance/Halo** Damper Mode (see above). These parameters only affect the Resonance/Halo that is enabled when pressing the Damper pedal down when a note is already playing.

- > Use the **Attack Time** parameter to set the time needed to the Resonance/Halo to reach the maximum level after the Damper pedal has been pressed. Values (0...99) are relative to the current Amplitude Envelope Attack value.
- > Use the **Release Time** parameter to set the time needed to the Resonance/Halo to fade out after the Damper pedal has been released. Values (0...99) are relative to the current Amplitude Envelope Release value.
- > Use the **Volume Scaling** parameter to set the volume of the Resonance/Halo effect. Values (0...100%) are relative to the current level of the sound, as determined by the sum of the Multisample Volume, Velocity value and the current Amplitude Envelope value. 0% is no volume at all.

■ Setting a key range without dampers

In an acoustic piano, the felt dampers can only dampen strings up to a certain note. Starting from that note (usually G6), it is as if the Damper pedal was always pressed down, and the dampers removed from the strings.

- > When the Damper is in **Normal** mode (see above), use the **No Note Off Range > From Note** parameter to choose the note (C#-1...G9) starting from which notes are never dampened.

This parameter has no effect on the **Resonance/Halo** mode.

Triggering notes when pressing or releasing the Damper pedal

Special effects can be achieved by triggering notes with the Damper pedal.

- Go to the **Sound Edit > Menu > Basic > Damper Trigger** page.

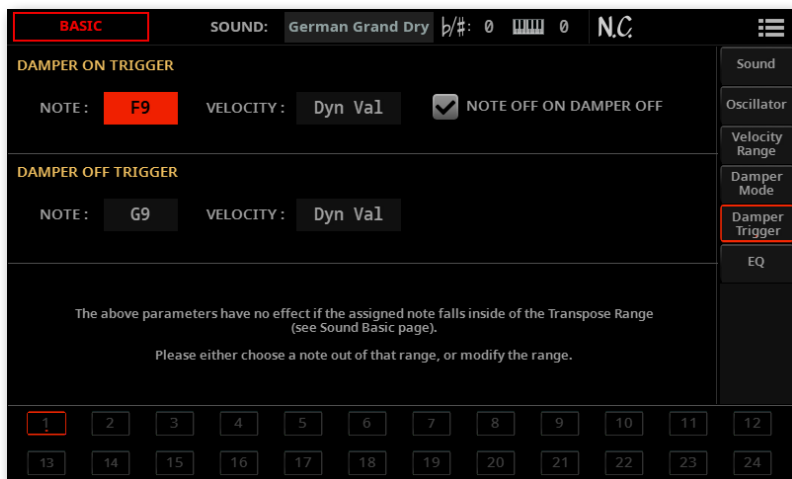

The parameters in this page apply to the Sound as a whole, and not to a single oscillator.

As warned by the message on the lower area of the display, triggered notes must fall out of the **Transpose Range** programmed in the **Sound Edit > Basic > Sound** page. Please either choose a note out of that range, or edit the Transpose Range, so that the note is either higher or lower than that range.

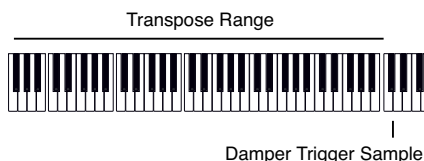

■ Playing a note when pressing the Damper pedal

The **Damper On Trigger** parameters allow to play a note when pressing the Damper pedal (Damper On).

This is useful when a special sample is assigned to a particular note (for example, pedal down squeaking in the Sound 'German Grand Solo', breathing in the 'Harmonica 1 DNC' Sound...).

- > Choose a **Note**, and set its **Velocity**.
- > Select the **Note Off on Damper Off** checkbox to make the sound stop when the Damper pedal is released.

■ **Playing a note when releasing the Damper pedal**

The **Damper Off Trigger** parameters allow to play a note when releasing the Damper pedal (Damper Off).

Releasing the Damper pedal can play a special sample assigned to a particular note (for example, Damper pedal release noise in the 'German Grand Solo' Sound).

- > Choose a **Note**, and set its **Velocity**.

Equalizing the Sound

You can use a three-band, semi-parametric equalizer on each oscillator.

- Go to the **Sound Edit > Menu > Basic > EQ** page.

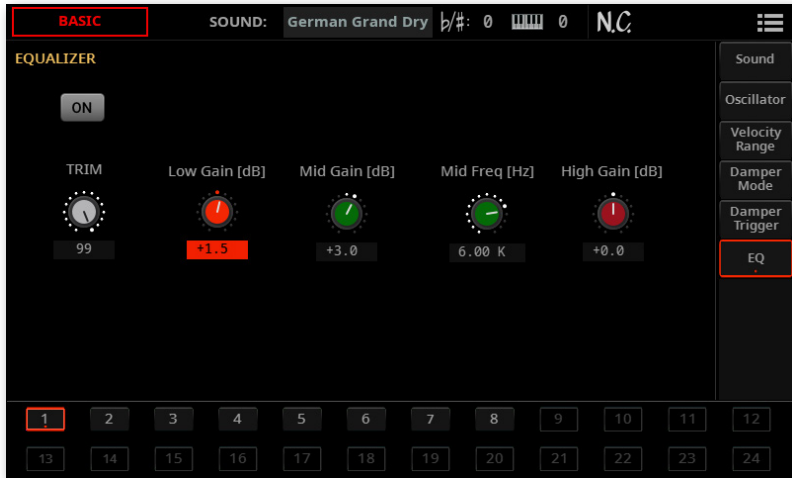

■ Activating the EQ

- Use the **On/Off** button to activate the equalizer on the selected oscillator.

■ Trimming and programming the EQ

- Use the **Trim** knob to limit the level of the signal passing through the equalizer (0...99). Extreme equalization values can overload the audio circuits and lead to distortion. This control lets you set equalization as desired, and at the same time avoid overloading.
- Use the **EQ controls** to create the equalization curve.

EQ Control	Meaning	Value
Low Gain	Low frequencies equalization. This is a shelving curve filter.	-18...+18dB
Mid (Middle) Gain	Middle frequencies equalization. This is a bell curve filter.	-18...+18dB
Mid (Middle) Freq	Centre frequency of the middle frequencies equalization.	0.100...10kHz
Hi (High) Gain	High frequencies equalization. This is a shelving curve filter.	-18...+18dB

Setting the Drum Kit's basic parameters

When editing a Drum Kit, you first choose and set the percussive samples assigned to each key and velocity layer.

- > Go to the **Sound Edit > Menu > Drum Kit > Drumkit** page.



Selecting and setting a key

The key can be selected and programmed in the **KEY** section.



■ Choosing the key to edit

- > Use the **Key** parameter to select a key. As an alternative, select it by pressing a key on the keyboard.

■ Choosing the number of layers per key

Each key can have a variable number of velocity zones (layers). This allows for assigning different samples to different playing velocity strengths.

> Use the **Layers** pop-up menu to choose the number of layers assigned to the selected key. Depending on the number of selected layers, a different number of velocity switches will become available.

■ Turning the key on or off

> Use the **Assign** checkbox to turn the selected key on/off. When a key is not assigned, the next assigned key on the right will extend over it.

■ Selecting the dry or ambient portion of the sound

You can separately listen to the dry or ambient portion of the percussive samples while editing.

> Use the **Dry+Amb** pop-up menu to choose the dry and/or ambient portion of the sound.

Layer and velocity switch

After having selected a key to edit, choose the velocity layer.



■ Choosing the layer to edit

> Use the **radio buttons** in the **Layer Selector & Velocity Sample Switch** area to select the layer to edit. The available number of layers depend on the **Layers** pop-up menu in the area above.

■ Editing the velocity switches

Each of the **velocity switch values** in the **Layer Selector & Velocity Sample Switch** area separates two adjacent layers of the selected key. Notes stricken harder than a velocity switch will be played by the layer on the right, while notes stricken softer are played by the layer on the left.

The first and last values are not editable, and are always 001 and 127 (respectively).

Choosing and setting the drum samples

Use the **Drum Sample** section to assign a percussive sample to the selected velocity layer inside the selected key.

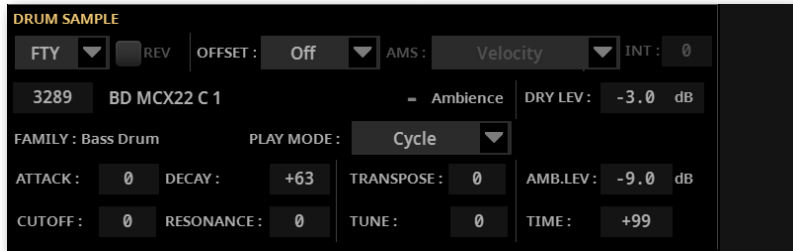

The available parameters depend on the selected sample.

■ Choosing a drum sample

> Use the **Drum Sample** parameters to assign a different drum sample to each layer. You can use velocity to switch between the available samples. **Offset** and **Level** can be adjusted independently for the various drum samples.

Use the **pop-up menus** to choose the **bank** (Factory or User).

Use the **numeric field** next to the sample name to choose the **sample** inside the selected bank.

Bank	Meaning
FTY	Factory samples, supplied by KORG as standard.
USR	User samples, loaded when loading some User Drum Kits.

The sample you select for the current layer will be triggered by velocities higher than the value of the velocity switches. If you do not wish to use velocity switching, assign just one layer to the selected key, and assign a sample only to layer 1.

If you create a new Drum Kit based on User samples, the User samples must be loaded from an internal or external drive. In case samples are not loaded, no sound will be heard, even if the Drum Kit can be selected and its name appears in the display.

> Select the **Rev (Reverse)** checkbox to play the sample in reverse (if this is allowed by the sample). In the case of samples that were originally specified to loop, the sample will be played back in one-shot reverse mode. If the sample was originally set to reverse, it will playback without change.

■ Setting a sample start offset

> Use the **Offset** pop-up menu to specify the point where the sample will start to play. Please note that this parameter is not available on all the Drum samples.

Offset	Meaning
Off	The sound will start from the beginning of the sample.
1st...6th	The sound will begin from the offset location pre-determined for each sample.
No Attack	The initial portion of the multisample is ignored.
AMS	Activates the Alternate Modulation Source (see below).
Pseudo Random	(Only works when more than one Offset point is available in the multi-sample). Randomly selects one of the available Offset points.

> Use the **AMS** and **Int(ensity)** parameters to choose the AMS modulation source and its intensity.

When the Intensity parameter has a positive value, the selected Offset point will depend on the AMS value. For example, with the Velocity AMS, playing softly will select the Off or 1st Offset, while playing loudly will select the 6th or No Attack Offset.

When the Intensity parameter has a negative value, the selection will happen in reverse (higher-numbered Offsets will be selected before the lowest-numbered ones).

■ Setting the sample level

> Use the **Dry Lev(el)** parameter to specify the level of the sample.

■ Programming the sample envelope

> Use the **Attack** and **Decay** parameters to offset the selected sample's EG Attack and Decay segments.

■ Programming the filter

> Use the **Cutoff** and **Resonance** parameters to set the cutoff frequency and resonance for the filter applied to the selected sample.

■ Setting transpose and fine tuning

- > Use the **Transpose** parameter (-64...+63 semitones) to transpose the selected sample. Use it to change the pitch of the selected key.
- > Use the **Tune** parameter (-99...+99 cents of a semitone) to fine-tune the assigned sample.

■ Adjusting the ambient level and time

- > Use the **Amb Level / Time** parameters to adjust the ambient level and decay time.

These parameters are only available if the selected Drum sample is of the Ambient type. When these parameters are available, **Level** controls the volume of the direct (dry) sounds, while **Amb. Level** and **Time** control the volume and length of the ambience respectively.

Equalizing the Drum Kit

Each of the drum samples can be processed with a three-band, semi-parametric equalizer.

- > Go to the **Sound Edit > Menu > Drumkit > EQ** page.

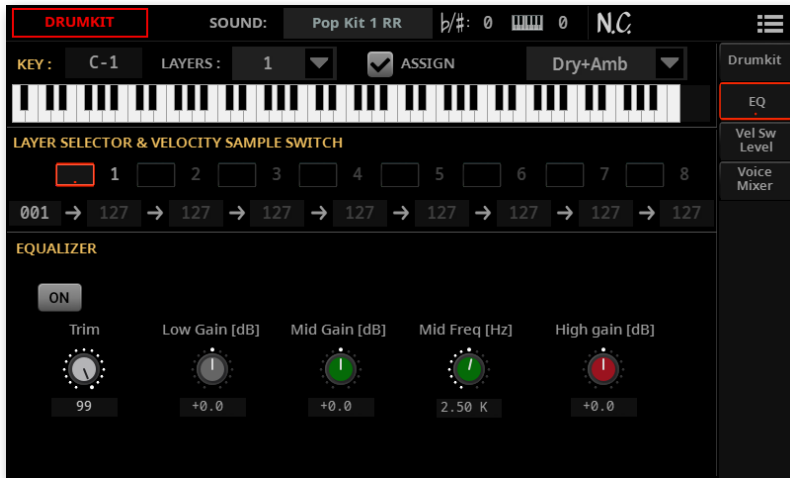

■ Choosing the key to edit

- > Use the **Key** parameter to select a key. As an alternative, select it by pressing a key on the keyboard.

The **Layers** and **Assign** parameters are the same as in the **Drumkit** page.

■ Trimming and programming the EQ

- > Use the **On/Off** button to activate the equalizer on the selected layer.
- > Use the **Trim** knob to limit the level of the signal passing through the equalizer (0...99). Extreme equalization values can overload the audio circuits and lead to distortion. This control lets you set equalization as desired, and at the same time avoid overloading.

- > Use the **EQ controls** to create the equalization curve.

EQ Control	Meaning	Value
Low Gain	Low frequencies equalization. This is a shelving curve filter.	-18...+18dB
Mid (Middle) Gain	Middle frequencies equalization. This is a bell curve filter.	-18...+18dB
Mid (Middle) Freq	Centre frequency of the middle frequencies equalization.	0.100...10kHz
Hi (High) Gain	High frequencies equalization. This is a shelving curve filter.	-18...+18dB

Mixing the Drum Kit layers

You can see all the drum samples, dry/ambient levels, and velocity switches of the available layers in a single page. While in this page, you can see which layer is playing.

- > Go to the **Sound Edit > Menu > Drumkit > Velocity Switch Level** page.

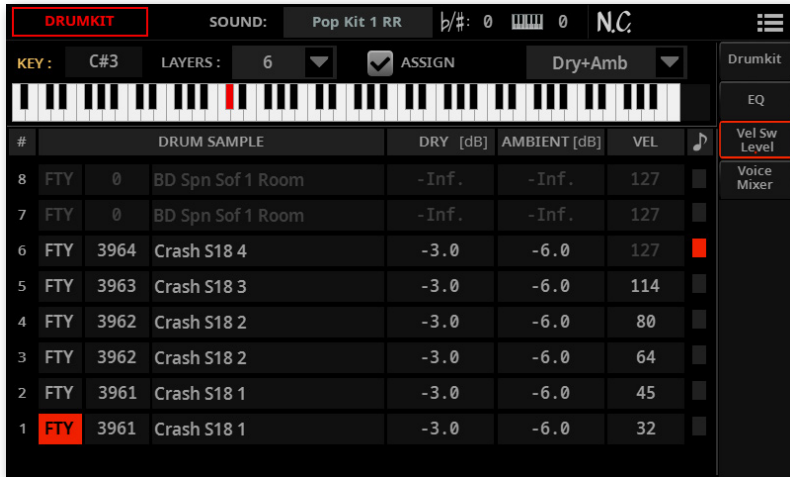

■ View which layer is playing

- > Play a note on the keyboard. Depending on the velocity, an indicator will turn on on the extreme right of the page, next to the layer that is playing.

■ Choose the drum sample

- > Use the **FTY/USR** parameter to choose the bank (Factory or User).

Bank	Meaning
FTY	Factory samples, supplied by KORG as standard.
USR	User samples, loaded when loading some User Drum Kits.

- > Use the **numeric field** next to the sample name to choose the **sample** inside the selected bank.

■ Adjust the dry/ambient level

- > Use the **Dry** and **Ambient Level** parameters to adjust the level of the dry and ambient portion of the sound.

■ Adjust the velocity switch

- > Use the **Vel** parameter to adjust the velocity switch between the layers.

Mixing and retriggering the drum samples

You can choose a triggering mode, and mix the key (usually a percussive sound with its different velocity layers) with the other keys. All layers of the selected key will get the same settings.

- > Go to the **Sound Edit > Menu > Drumkit > Voice/Mixer** page.



■ Choosing the key to edit

- > Use the **Key** parameter to select a key. As an alternative, select it by pressing a key on the keyboard.

The **Layers** and **Assign** parameters are the same as in the **Drumkit** page.

■ Choosing polyphony, retriggering and legato

- > Use the **Single Trigger** checkbox to choose the triggering mode.

Single Trigger	Meaning
On	When the same key (note) is played repeatedly, the previous note will be stopped before the new note is triggered, so that they will not overlap.
Off	When the same key (note) is played repeatedly, the previous note will not be stopped before the new note is triggered.

■ Creating exclusive groups

Exclusive Groups are sets of mutually exclusive keys, stopping each other. For example, if the Open Hi-Hat and Closed Hi-Hat are assigned the same **Exclusive Group**, playing an Open Hi-Hat will stop the Closed Hi-Hat playing.

Exclusive Group	Meaning
None	No Exclusive Group assigned. The selected key will not be stopped by any other key.
1...127	Exclusive Groups assigned to the selected key. When you play this key, all other keys assigned to the same Exclusive Group will be stopped, and this key will be stopped by other keys assigned to the same Exclusive Group.

■ Fading out the grouped samples

Use the **Choke Fade Out Time** parameter to set the speed at which the samples pertaining to the same Exclusive Group will fade out, when another key in the same group is pressed. This is useful to simulate, for example, the Hi-Hat pedal, 'chocking' the semi-open sounding note only gradually.

Use the **Subgroup Choke Off** checkbox to let the previously sounding note in the same Exclusive Group (including the same note) play when a new key in the same group is played. This is useful to simulate, for example, a Ride Cymbal, whose notes are not 'choked' by playing subsequent notes.

■ Enabling Note On and Note Off

- > Select the **Enable Note On Receive** checkbox to enable reception of the Note On (Key On) message. If this parameter is not selected, the key will not play.
- > Select the **Enable Note Off Receive** checkbox to enable reception of the Note Off (Key Off) message. If this parameter is not selected, the sample will continue to play up to its end.

■ Setting the Level, Pan and FX Send mixing parameters

- > Use the **Level** parameter to set the level of the selected key.
- > Use the **Pan** parameter to set the position of the selected key in the stereo panorama.
- > Use the **Send to MFX1-3** parameters to set the MFX1, MFX2 and MFX3 send level for the selected key.

Modulating pitch

Pitch can change depending on the note and the activated controllers. Pa5X also includes LFO generators that can modulate the pitch.

- Go to the **Sound Edit > Menu > Pitch > Pitch Mod(ulation)** page.



Controlling pitch

The oscillator's pitch can follow the natural scale, or a different pitch 'slope'.



■ Setting the Pitch Slope

- Use the **Pitch Slope** parameter (-1.0...+2.0) to change pitch depending on the note position on the keyboard.

Normally you will leave this parameter at +1.0. Positive (+) values will cause the pitch to raise as you play higher notes, and negative (-) values will cause the pitch to fall as you play higher notes.

With a value of 0, there will be no change in pitch, and the C4 pitch will sound regardless of the keyboard location you play.

The diagram shows how the Pitch Slope and pitch are related:

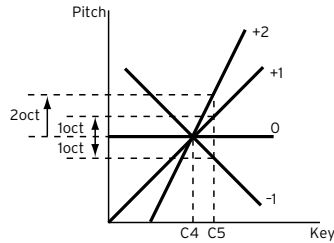

■ Controlling the pitch with physical controllers

- > Use the **Pitch Mode** pop-up menu to set the Pitch Bend direction.

Pitch Mode	Meaning
Normal	Linear bending.
Fixed Scale	When this parameter is turned on on an oscillator, Pitch Bend and Sub Scale have no effect on its tuning. The relevant parameters are greyed out and non-selectable.
Highest Pitch Bend only	On this oscillator, Pitch Bend is only activated on the highest note currently playing on the keyboard.
Lowest Pitch Bend only	On this oscillator, Pitch Bend is only activated on the lowest note currently playing on the keyboard.

- > Use the **Ribbon to Pitch** parameter to set the Pitch Bend range (-12...0...+12 semitones) controlled by the Ribbon Controller message (CC#16). The Ribbon Controller message can be received from MIDI or contained in a Standard MIDI File.

- > Use the **JS (+X)** parameter to specify how the pitch will change when the joystick is moved all the way to the right (-60...+12 semitones). A setting of 12 produces 1 octave of change.

For example if you set this to +12 and move the joystick all the way to the right, the pitch will rise one octave above the original pitch.

- > Use the **JS (-X)** parameter to specify how the pitch will change when the joystick is moved all the way to the left (-60...+12 semitones). A setting of 12 produces 1 octave of change.

For example, if you set this to -60 and move the joystick all the way to the left, the pitch will fall five octaves below the original pitch. This can be used to simulate the downward swoops that a guitarist produces using the tremolo arm.

■ Choosing a pitch modulation source

> Use the **Pitch > AMS** (Alternate Modulation Source) pop-up menu to select a modulation source for the pitch of the selected oscillator. A list of the available AMS sources is in the Appendix.

The **Intensity** parameter (-12.00...+12.00) specifies the depth and direction of the effect produced by the AMS. With a value of 0, no modulation will be applied. With a value of 12.00, the pitch will change up to one octave.

For example, if you choose the JS (-Y) AMS and move the joystick downwards, the pitch will rise if this parameter is set to a positive (+) value, or fall if this parameter is set to a negative (-) value. The range is a maximum of one octave.

Controlling the Pitch EG (Envelope Generator)

Use the **Pitch EG** parameters to controls the Pitch EG unique to all oscillators.



■ Linking pitch to the envelope

> The **Intensity** parameter (-12.00...+12.00) specifies the depth and direction of the Pitch EG modulation. With a value of 12.00, the pitch will change a maximum of ± 1 octave.

■ Linking pitch to an AMS modulation

> Use the **Pitch EG > AMS** parameter to select a modulation source for the pitch EG of the selected oscillator. A list of the available AMS sources is in the Appendix.

> Use the **Pitch EG > Intensity** parameter to specify the depth and direction of the AMS. For example, if you choose the Velocity AMS and set this value to +12.00, the velocity will control the range of pitch change produced by the pitch EG in a range of ± 1 octave. As you play more softly, the pitch change will draw closer to the pitch EG levels.

The **Pitch EG > AMS** and **Pitch EG > Intensity** will be summed to determine the depth and direction of the pitch modulation applied by the pitch EG.

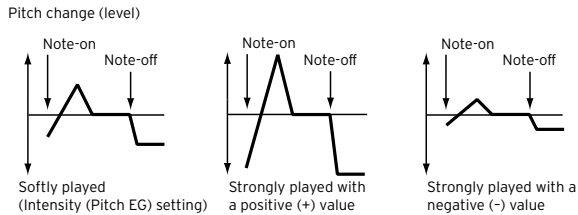

Programming Portamento

Portamento adds a slide between notes (a smooth change in pitch from one note to the next).

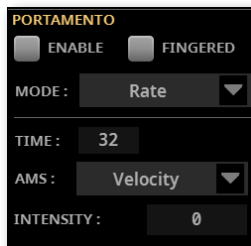

- > Select the **Enable** checkbox to activate the portamento effect. Portamento will also be switched on or off when the CC#65 (Portamento SW) message is received.
- > Select the **Fingered** checkbox to make portamento restart when playing a note. When Fingered is enabled, playing legato will turn Portamento on, while playing detached will turn it off again.
- > Use the **Mode** pop-up menu to choose the Portamento mode.

Mode	Meaning
Rate	Portamento will take a particular time to glide a given distance in pitch – for instance, one second per octave. Put another way, gliding several octaves will take much longer than gliding a half-step.
Time	Portamento will always take the same amount of time to glide from one note to another, regardless of the difference in pitch. This is especially useful when playing chords, since it ensures that each note in the chord will end its glide at the same time.

- > Use the **Time** parameter to set the portamento time (000...127). Increasing the value will produce a slower change in pitch.
- > Use the **AMS** and **Intensity** parameters to choose the AMS modulation source and its intensity for the **Time** parameter.

The **Intensity** parameter controls the depth and direction of the Portamento Time AMS modulation.

Controlling the LFO

Use the **LFO 1/2** parameters to control the LFO (Low Frequency Oscillation) on the selected oscillators. LFO generators are programmed in the **Sound Edit > LFO > LFO 1** and **LFO 2** pages.



- > Use the **LFO 1/2 Int** parameter to set the intensity (-12...0...+12) of the corresponding LFO. Negative values will invert the LFO shape.
- > Use the JS+Y parameter to set the intensity (-12...0...+12) of the corresponding LFO when the joystick is pushed forward. Negative values will invert the LFO shape.
- > Use the **AMS** and **Intensity** parameters to choose an AMS to modulate the corresponding LFO, and the intensity of the modulation.

Programming the pitch envelope (Pitch EG)

Pa5X includes a pitch envelope generator (Pitch EG) that can vary the pitch over time.

- > Go to the **Sound Edit > Menu > Pitch > Envelope Generator** page.

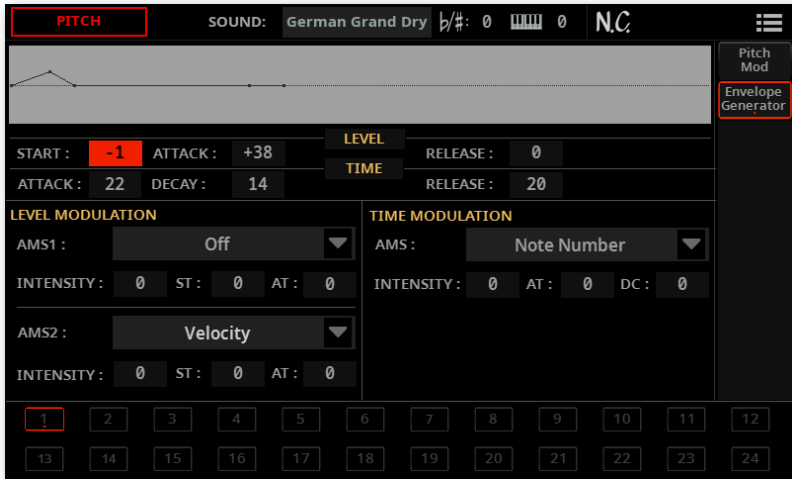

You can see the shape of the envelope in the diagram on top of the page.

Setting the Pitch EG levels and times

Pitch EG can be programmed by setting the **Level** and **Time** parameters of the envelope segments.

Time-varying pitch settings (when Pitch EG Intensity = +12.00)

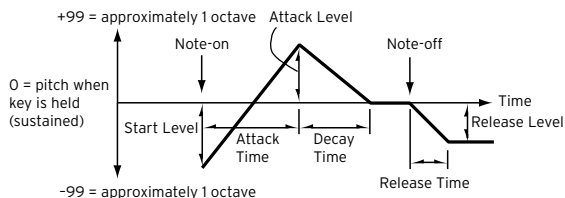

- > Use the **Level** parameters (-99...+99) to specify the amount of pitch change.

EG Level	Meaning
Start	Amount of pitch change at note start.
Attack	Amount of pitch change when the attack time has elapsed.
Release	Amount of pitch change when the release time has elapsed.

The actual amount of pitch change will depend on the **Envelope Generator > Pitch Mode > Intensity** parameters. For example, with an Intensity setting of +12.00, a Level setting of +99 would raise the pitch one octave, and a Level setting of -99 would lower the pitch one octave.

- > Use the **Time** parameters (0...99) to specify the time over which the pitch change will occur.

EG Time	Meaning
Attack	Time over which the pitch will change from note-on until it reaches the pitch specified as the attack level.
Decay	Time over which the pitch will change after reaching the attack level until it reaches the normal pitch.
Release	Time over which the pitch will change from note-off until it reaches the pitch specified as the release level.

Modulating the Pitch EG

■ Modulating the Pitch EG levels

Use the **Level Modulation > AMS 1/2** parameters to select a modulation source for the **Pitch EG > Level** parameters.

- > Use the **Level Modulation > Intensity** parameters (-99...+99) to specify the depth and direction of the modulation generated by **AMS1** or **AMS2**. With a value of 0, the levels specified by the **Level** parameters will be used.

For example, if you choose the Joystick Y+ AMS, moving the Joystick up will change the Level parameters. The direction of the change is specified by St (Start Level Swing) and At (Attack Level Swing). When the Joystick is released, the Pitch EG levels will return to their own settings.

If you choose the Velocity AMS, higher absolute values of Intensity will produce increasingly wider changes in Pitch EG levels when playing harder. The direction

of the change is specified by St (Start Level Swing) and At (Attack Level Swing). As you play more softly, the pitch change will be closer to the Pitch EG levels.

> Use the **St (Start Level Swing)** and the **At (Attack Level Swing)** parameters to specify the direction of change in Level > Start and Level > Attack caused by the AMS.

If the Intensity is a positive (+) value, a setting of + will increase the EG level, and a setting of - will decrease it. With a value of 0 there will be no change.

Pitch EG change (level) (AMS=JS-Y/Velocity, Intensity= positive (+) value)

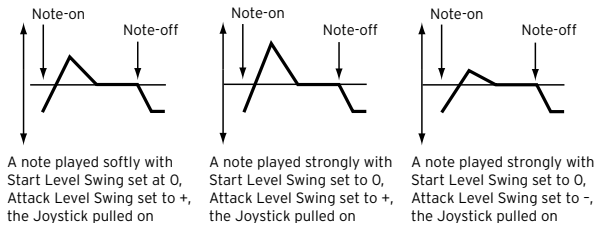

■ Modulating the Pitch EG times

Use the **Time Modulation > AMS** parameter to select a modulation source for the **Pitch EG > Time** parameters.

> Use the **Time Modulation > Intensity** parameters (-99...+99) to specify the depth and direction of the effect that AMS will have on the Time parameters. With a value of 0, the pitch EG times will be just as specified by the Time settings.

The alternate modulation value at the moment that the EG reaches each point will determine the actual value of the EG time that comes next.

For example, the decay time will be determined by the alternate modulation value at the moment that the attack level is reached.

When this parameter is set to values of 16, 33, 49, 66, 82, or 99, the specified EG times will speed up as much as 2, 4, 8, 16, 32, or 64 times respectively (or slowed down to 1/2, 1/4, 1/8, 1/16, 1/32, or 1/64 of the original time).

For example, with the Velocity AMS, increasing the absolute value of Intensity will allow strongly-played notes to increase the changes in pitch EG Time values. The direction of the change is specified by At (Attack Time Swing) and Dc (Decay Time Swing). As you play more softly, the pitch EG times will more closely approach the actual settings of the pitch EG.

> Use the **At (Attack Time Swing)** and the **Dc (Decay Time Swing)** parameters to specify the direction in which AMS will affect the Time > Attack and Decay parameter. With positive (+) values of Intensity, a setting of + will cause the time to

be lengthened, and a setting of - will cause the time to be shortened. With a value of 0 there will be no change.

Pitch EG changes (Time) (AMS = Velocity, Intensity = positive (+) value)

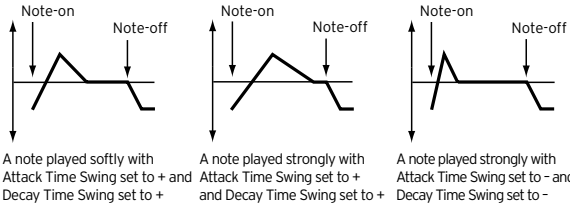

Programming the filters

As in a subtractive analogue synthesizer, filters are the main agents of the sound's timbre quality. Envelope and modulation allow for timbral shift over time, making the sound alive.

Choosing the filters

You can choose one of two filters for the selected oscillator.

- Go to the **Sound Edit > Menu > Filter > Type** page.

The screenshot shows the 'FILTER' page in a software interface. At the top, it says 'SOUND: German Grand Dry' with various parameters like 'b/#: 0' and 'N.C.'. The 'FILTERS' section has two radio buttons: 'LOW PASS RESONANCE' (which is selected and highlighted with a red box) and 'LOW PASS & HIGH PASS'. Below this is a 'TRIM' knob set to '99'. A graph shows a resonance peak. The 'FILTER A' section has 'FREQUENCY: 26', 'RESONANCE: 0', and 'INTENSITY: 0'. The 'FILTER B' section has 'FREQUENCY: 6'. A vertical menu on the right has 'Type' selected. At the bottom is a 2x12 grid of buttons numbered 1 to 24, with button '1' highlighted.

With Low Pass Resonance selected

The screenshot shows the same 'FILTER' page, but now 'LOW PASS & HIGH PASS' is selected and highlighted with a red box. The graph shows a different filter response curve. The 'TRIM' knob is still at '99'. The 'FILTER A' and 'FILTER B' parameters remain the same. The vertical menu on the right still has 'Type' selected. The 2x12 grid of buttons at the bottom still has button '1' highlighted.

With Low Pass & High Pass selected

■ Choosing the filter type

> Use the **Filters** radio buttons to choose the type of filter for the selected oscillator.

Filter Type	Meaning
Low Pass Resonance	This is a 24dB/oct filter. When the Low Pass filter type is selected, only filter A will be activated.
Low Pass & High Pass	These are two 12dB/oct filters in series. When the Low Pass & High Pass filter type is selected, filter B will be activated.



■ Trimming the filter input

> Use the **Trim** parameter (00...99) to adjust the level at which the audio signal generated by the selected oscillator enters filter A.

If this value is too high, the sound may distort when Resonance is set to a high value, or when you play a chord.

Programming the filters

■ Programming filter A

> Use the **Filter A > Frequency** parameter to set the cutoff frequency of filter A (00...99).

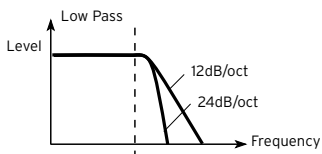

This is a filter that cuts the high-frequency region above the cutoff frequency. This is the most common type of filter, and is used to cut part of the overtone components, making an originally bright timbre sound more mellow (darker). When the "Filter Type" is Low Pass Resonance, the cutoff will have a steeper slope.

> Use the **Filter A > Resonance** parameter to set the resonance of filter A (00...99).

The resonance emphasizes the overtone components that lie in the region of the cutoff frequency specified by Frequency, producing a more distinctive sound. Increasing this value will produce a stronger effect.

- > Use the **Res. Mod. by AMS** parameter to choose a modulation source for the Resonance parameter.

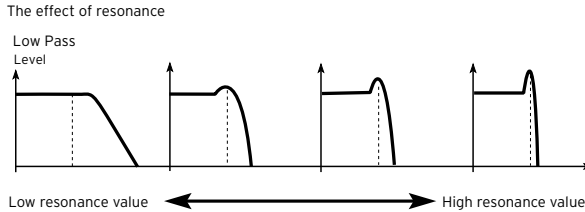

- > Use the **Intensity** parameter (-99...+99) to specify the depth and direction of the effect that Res. Mod. by AMS will have on the resonance level specified by Resonance.

For example, if Velocity has been selected, playing harder or softer will affect the resonance.

With positive (+) values, the resonance will increase as you play harder, and as you play softer the resonance will approach the level specified by the Resonance setting.

With negative (-) values, the resonance will decrease as you play harder, and as you play softer the resonance will approach the level specified by the Resonance setting.

The resonance level is determined by summing the Resonance and Intensity values.

■ Programming filter B

When both filters are activated, you can also program filter B.

- > Use the **Filter B > Frequency** parameter to set the cutoff frequency of filter B (00...99).

This parameter is only available when the selected filter type is Low Pass & High Pass.

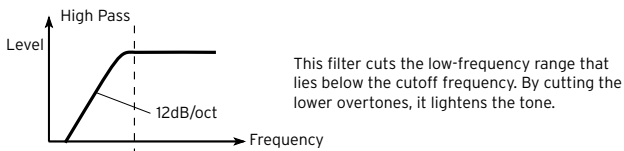

Modulating the filters

You can modulate the filter cutoff frequency of the selected oscillator. Modulation will add dynamic timbre variation.

Programming realtime filter modulation

- Go to the **Sound Edit > Menu > Filter > Mod(ulation)** page.



When the filter type is Low Pass Resonance, the parameters for filter B will not be editable (dimmed).

Tracking the cutoff frequency across the keyboard

Keyboard Tracking changes the timbre quality across the keyboard.

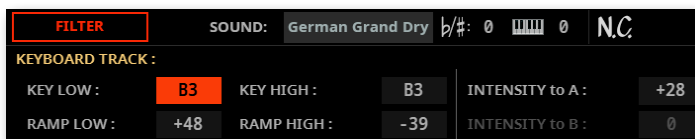

- Use the **Key Low/High** parameters (C-1...G9) to change the filter cutoff frequency across the keyboard for the selected oscillator.

Keyboard Tracking varies the cutoff frequency according to the position of the key on the keyboard. How the cutoff frequency is affected by the keyboard loca-

tion can be specified by the Key Low, Key High, Ramp Low, Ramp High, and the Intensity to A/B parameters.

Keyboard tracking will apply to the range below the specified Low note number, and above the specified High note number.

> Use the **Ramp Low/High** parameters to specify the slope of the keyboard tracking (-99...+99).

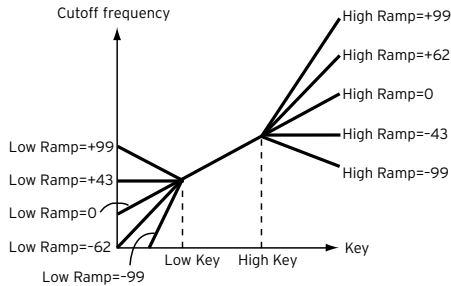

> Set the **Intensity to A** and **Intensity to B** parameters (-99...+99) to specify the depth and direction of the changes applied to filters A and B.

For the range of notes between Key Low and Key High, the cutoff frequency will change according to the keyboard location (pitch).

Modulating the Filter EG (Envelope Generator)

The filter envelope can be controlled while playing.

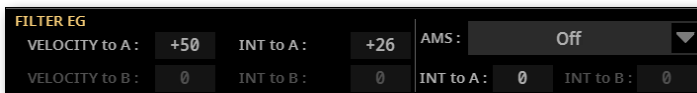

> Use the **Velocity to A/B** parameter (99...+99) to specify the depth and direction of the effect that velocity will have on the time-varying changes created by the filter EG (as set on Filter > Filter EG) to control the filter A/B cutoff frequency.

With positive (+) values, playing harder will cause the filter EG to produce greater changes in cutoff frequency. With negative (-) values, playing harder will also cause the filter EG to produce greater changes in cutoff frequency, but with the polarity of the EG inverted.

> Use the **Int to A/B** parameters (-99...+99) to specify the depth and direction of the effect that the time-varying changes created by the filter EG will have on the filter A/B cutoff frequency.

With positive (+) settings, the sound will become brighter when the EG levels set by Filter EG Level and Time parameters are in the '+' area, and darker when they are in the '-' area.

With negative (-) settings, the sound will become darker when the EG levels set by Filter EG Level and Time parameters are in the '+' area, and brighter when they are in the '-' area.

- > Use the **AMS** pop-up menu to select a modulation source for the filter EG applied to the cutoff frequency of filters A and B.
- > Use the **Int to A/B** parameters (-99...+99) to specify the depth and direction of the effect that the AMS will have on filter A/B.

The sum of the settings for Velocity to A/B, Intensity to A/B, and (AMS) Intensity to A/B will determine the depth and direction of the effect produced by the filter EG.

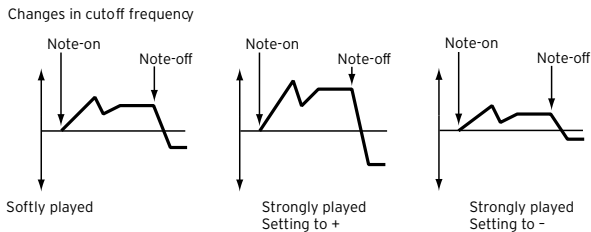

Modulating the filters cutoff frequency

You can control the filters with a modulation source.



- > Use the **AMS 1/2** parameters to select a modulation source for the filter A/B cutoff frequency.
- > Use the **Intensity (AMS 1/2)** parameters to specify the depth and direction of the AMS 1/2.

When AMS1 is JS X, a positive (+) value for this parameter will cause the cutoff frequency to rise when the joystick is moved toward the right, and fall when the joystick is moved toward the left. With a negative (-) value for this parameter, the opposite will occur.

This value is summed to the setting of the Filter A/B Frequency.

Applying LFO to the filters

You can use LFO to apply cyclic modulation to the cutoff frequency of the filters. This will create cyclical changes in tone on the selected oscillator.

- > Go to the **Sound Edit > Menu > Filter > LFO Mod(ulation)** page.

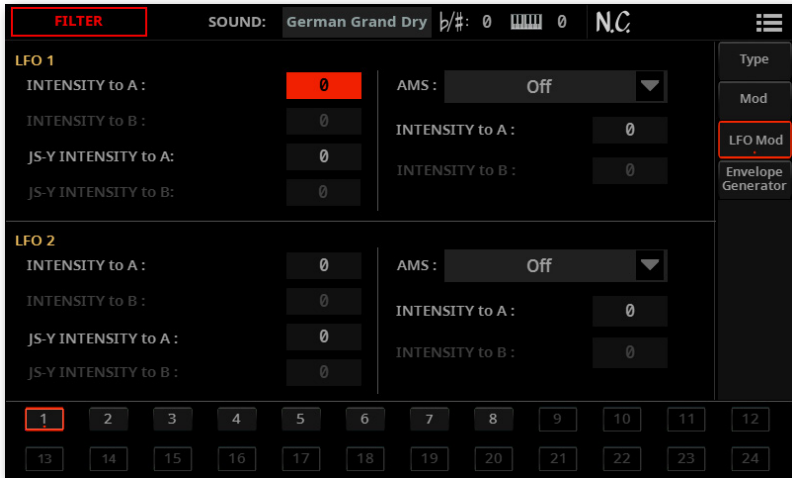

■ Modulating the filters with the LFOs

- > Use the **LFO 1/2 > Intensity to A/B** parameters (-99...+99) to specify the depth and direction of the modulation that LFO 1/2 (set on Sound Edit > LFO > LFO 1 or LFO 2) will have on the cutoff frequency of filter A/B. Negative (-) settings will invert the phase.

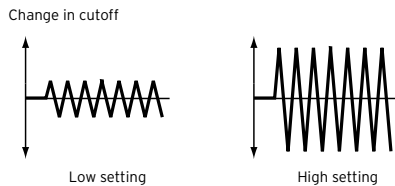

- > Use the **JS (Joystick) -Y Intensity to A/B** parameters (-99...+99) to modulate LFO with the joystick pulled back.

By moving the joystick in the Y direction (toward yourself), you can control the depth at which LFO 1/2 modulates the cutoff frequency of filter A/B. This parameter specifies the depth and direction of the control.

Higher settings of this parameter will produce greater increases in the effect of LFO 1/2 on the filter when the joystick is moved toward yourself.

> Use the **LFO 1/2 > AMS** pop-up menus to select a modulation source for the cutoff frequency of both filters A and B.

The **Intensity to A/B** parameters (-99...+99) set the depth and direction of the effect that the AMS will have on filter A/B.

For example if the AMS is Joystick Y+, higher settings of this parameter will allow greater change to be applied to LFO 1/2 when you move the Joystick up in the Y axis.

Programming the filter envelope (Filter EG)

You can create an envelope to vary over time the cutoff frequency of the filters on the selected oscillator.

- > Go to the **Sound > Filter > Envelope Generator** page.

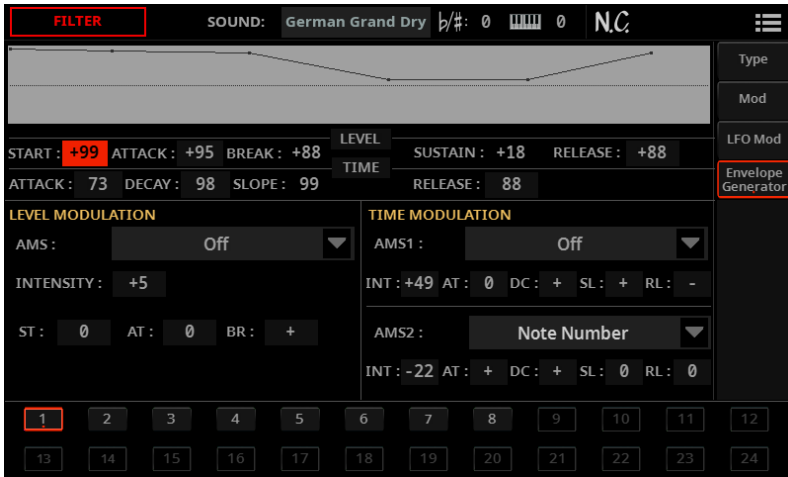

You can see the shape of the envelope in the diagram on top of the page.

Setting the Filter EG levels and times

Filter EG can be programmed by setting the **Level** and **Time** parameters of the envelope segments.

The result will depend on the filter type. For example, with the Low Pass Resonance filter, positive (+) values of EG Intensity will cause the tone to be brightened by positive (+) levels, and darkened by negative (-) levels.

Also, the effect of these settings on the filter cutoff frequency depends by the Velocity and Intensity parameters of the Filter > Modulation page.

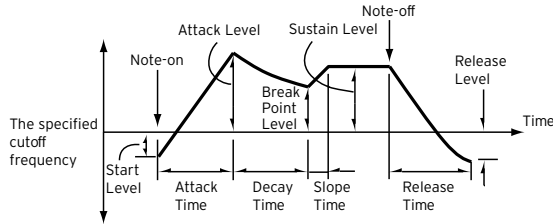

> Use the **Level** parameters (-99...+99) to specify the amount of cutoff frequency change.

EG Level	Meaning
Start	Change in cutoff frequency at the time of note-on.
Attack	Change in cutoff frequency after the attack time has elapsed.
Break (Break Point)	Change in cutoff frequency after the decay time has elapsed.
Sustain	Change in cutoff frequency that will be maintained from after the slope time has elapsed until note-off occur.
Release	Change in cutoff frequency that will occur when the release time has elapsed.

> Use the **Time** parameters (0...99) to specify the time over which the cutoff frequency change will occur.

EG Time	Meaning
Attack	Time over which the level will change from note-on until the attack level is reached.
Decay	Time over which the level will change from the attack level to the break point level.
Slope	Time over which the level will change after the decay time has elapsed until the sustain level is reached.
Release	Time over which the level will change after note-on occurs until the release level is reached.

Modulating the Filter EG

■ Modulating the Filter EG levels

- > Use the **Level Modulation > AMS** parameter to select the source that will control the Level parameters of the filter EG.
- > Use the **Level Modulation > Intensity** parameters (-99...+99) to specify the depth and direction of the **AMS**. With a value of 0, the levels specified by the **Frequency** parameter will be used.

For example, if AMS is Velocity, and you set St (Start Level Swing), At (Attack Level Swing) and Br (Break Level Swing) to + and set Intensity to a positive (+) value, the EG levels will rise as you play harder. If Intensity is set to a negative (-) value, the EG levels will fall as you play harder.

- > Use the **St (Start Level Swing)**, **At (Attack Level Swing)** and **Br (Break Level Swing)** parameters to specify the direction in which AMS will affect the Start, Attack and Break Point.

When Intensity has a positive (+) value, a setting of + for this parameter will allow the AMS to raise the EG level, and a setting of - will allow AMS to lower the EG level. With a value of 0 there will be no change.

Filter 1 EG changes (level) (AMS = Velocity, Intensity = a positive (+) value)

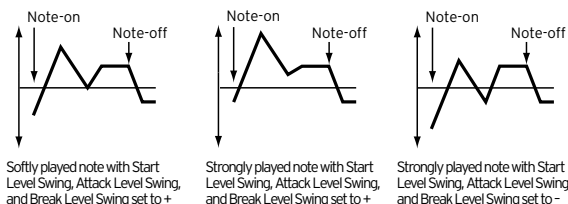

Modulating the Filter EG times

- > Use the **Time Modulation > AMS 1/2** parameters to select a modulation source for the Time parameters of the filter EG.
- > Use the **Time Modulation > Intensity** parameters (-99...+99) to specify the depth and direction of the effect that the AMS will have on the Time parameters. With a value of 0, the filter EG times will be just as specified by the Time settings.

For example, if the AMS is set to FltKTr +/+, the EG Time parameters will be controlled by the Keyboard Tracking settings. With positive (+) values of this parameter, positive (+) values of Ramp Low/High will lengthen the EG times, and negative (-) values of Ramp Low/High will shorten the EG times. The direction of change is specified by At (Attack Time Swing), Dc (Decay Time Swing), Sl (Slope Time Swing), and Rl (Release Time Swing).

With a value of 0, the times specified by the **Frequency** parameter will be used.

If the AMS is set to Velocity, positive (+) values of this parameter will cause EG times to lengthen as you play more strongly, and negative (-) values will cause EG times to shorten as you play more strongly.

- > Use the **At (Attack Time Swing)**, **Dc (Decay Time Swing)**, **Sl (Slope Time Swing)** and **Rl (Release Time Swing)** parameters to specify the direction in which the AMS will affect the Time > Attack, Decay, Slope and Release parameters.

With positive (+) values of Intensity, a setting of + will cause the time to be lengthened, and a setting of - will cause the time to be shortened. With a value of 0 there will be no change.

Filter 1 EG changes (Time) (AMS = Velocity, Intensity = a positive (+) value)

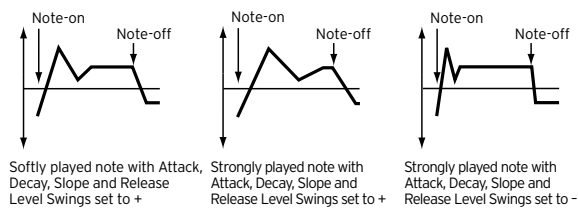

Programming amplitude and pan

You can program the amplitude and pan of each oscillator. Amplitude is the volume of the oscillators. Pan is the position of the oscillators in the stereo panorama. With amplitude envelope you can make the sound volume vary over time.

Setting the basic amplitude and pan values

You can set the basic volume and pan values of the selected oscillator.

- > Go to the **Sound Edit > Menu > Amp > Level/Pan** page.

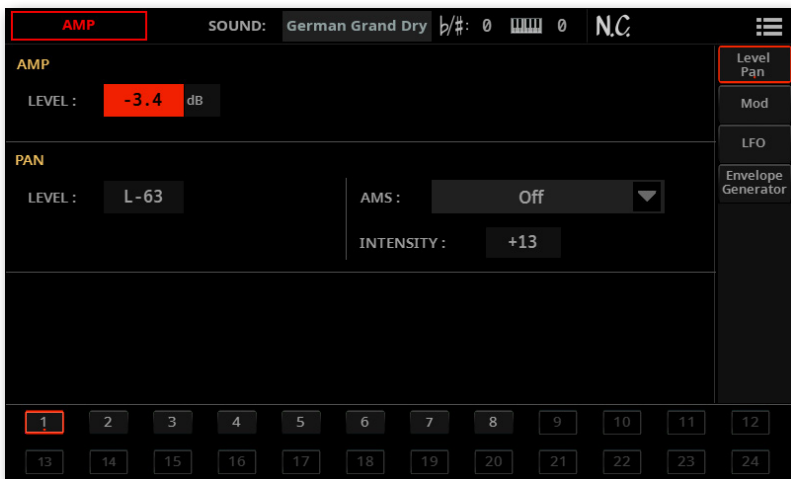

■ Setting the amplitude's basic level

- > Use the **Amp > Level** parameter (-Inf, -50.0...+0.0dB) to set the volume of the selected oscillator.

The volume of a Sound can be controlled by CC#7 (Channel Volume) and CC#11 (Expression). The resulting level is determined by multiplying the values of CC#7 and CC#11. The Global MIDI channel is used for this control.

■ Setting the pan's basic position

> Use the **Pan > Level** parameter to set the stereo position (panorama) of the selected oscillator.

This parameter is not available when editing a Drum Kit. Use the individual Pan control for each key instead (see the **Sound Edit > Drumkit > Voice/Mixer** page).

Pan	Meaning
Random	The sound will be heard from a different location at each note-on.
L-63...C00...R+63	Sound placed from Left (L) to Right (R). A value of C00 is Center (C).

The pan of a Sound can be controlled by CC#10 (Pan). A CC#10 value of 0 or 1 will place the sound at the far left, a value of 64 will place the sound at the location specified by the Pan setting for each oscillator, and a value of 127 will place the sound at the far right.

Modulating the pan position

Modulating the pan position makes the sound live between the stereo channels.

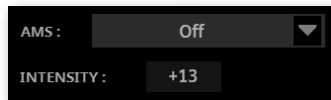

> Use the **AMS** pop-up menu to choose the modulation source that will modify the pan. This change will be relative to the Pan setting.

The **Intensity** parameter (-99...+99) specifies the depth of the effect produced by AMS. For example, if Pan is set to C064 and AMS is Note Number, positive (+) values of this parameter will cause the sound to move toward the right as the note numbers increase beyond the C4 note (i.e., as you play higher), and toward the left as the note numbers decrease (i.e., as you play lower). Negative (-) values of this parameter will have the opposite effect.

Modulating amplitude

Modulating the amplitude level of each oscillator makes the sound alive and ever-changing.

- > Go to the **Sound Edit > Menu > Amp > Mod(ulation)** page.

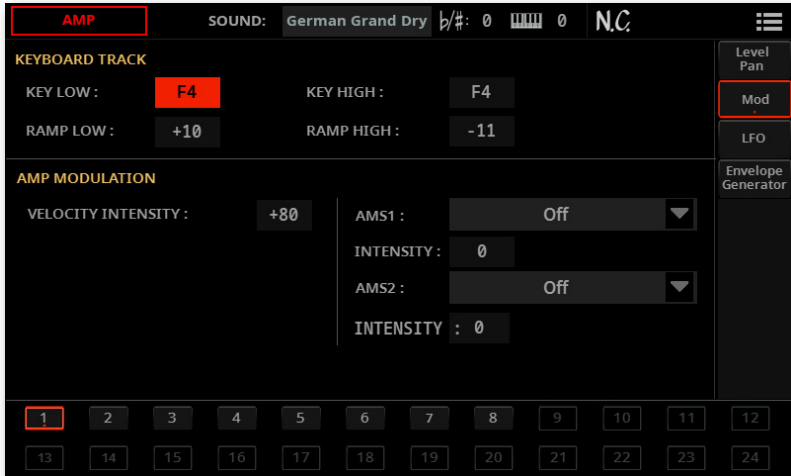

Tracking the amplitude across the keyboard

Use the **Keyboard Track** parameters to adjust the volume of the selected oscillator across the keyboard.

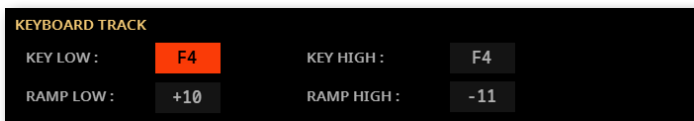

- > Use the **Key Low/High** parameters (C-1...G9) to specify keyboard tracking for the note number at which keyboard tracking will begin to apply. The volume will not change between Key Low and Key High.

Keyboard tracking will apply to the range below the specified Low note number, and above the specified High note number.

- > Use the **Ramp Low/High** parameters to specify the slope of the keyboard tracking (-99...+99).

With positive (+) values of the Ramp Low parameter, the volume will increase as you play notes below the Key Low note number. With negative (-) values, the volume will decrease.

With positive (+) values of the Ramp High parameter, the volume will increase as you play notes above the Key High note number. With negative (-) values, the volume will decrease.

Here is an example of volume changes produced by keyboard location and Ramp settings:

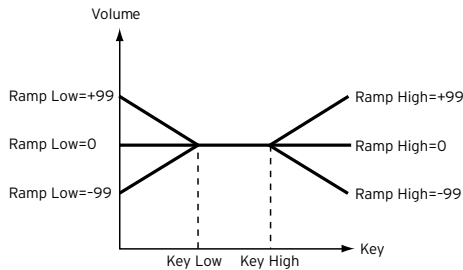

Modulating amplitude

Use the **Amp Modulation** parameters to specify how the volume of the selected oscillator will be affected by velocity and modulations sources.



> Use the **Velocity Intensity** parameter (-99...+99) to link velocity and volume.

With positive (+) values, the volume will increase as you play more strongly. With negative (-) values, the volume will decrease as you play more strongly.

Volume change (with positive (+) values of this parameter)

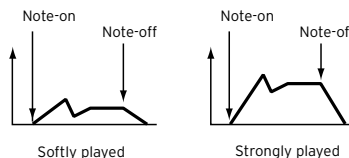

- > Use the **AMS 1/2** pop-up menus to select one or two modulation sources for the volume of the amp for the selected oscillator. Velocity cannot be selected as a source.

The **Intensity** parameter (-99...+99) specifies the depth and direction of the AMS. The actual volume will be determined by multiplying the value of the changes produced by the amp EG with the values of Alternate Modulation etc., and if the levels of the amp EG are low, the modulation applied by Alternate Modulation will also be less.

For example, if AMS is set to Joystick Y+, positive (+) values of this parameter will cause the volume to increase when you move the Joystick up in the Y axis. However if the EG settings etc. have already raised the volume to its maximum level, the volume cannot be increased further.

With negative (-) values of this parameter, the volume will decrease when pressure is applied to the keyboard.

Modulating amplitude with the LFOs

LFO is a cyclic modulation. Applied to the amplitude it produces an effect usually called ‘tremolo’. There are two LFO generators.

- > Go to the **Sound Edit > Menu > Amp > LFO** page.

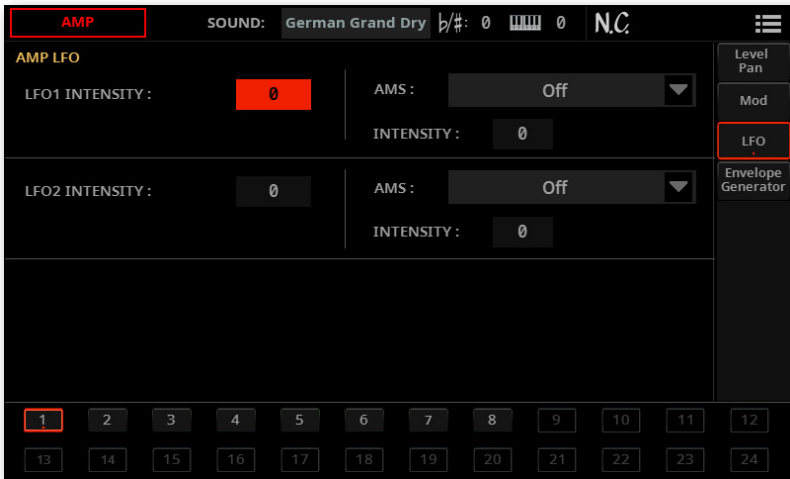

- > Use the **LFO 1/2 > Intensity** parameters (-99...+99) to adjust the effect of the cyclic modulation that LFO 1/2 (set in the LFO > LFO 1 and LFO 2 pages) will apply on the amp EG. Negative (-) settings will invert the phase.

Change in cutoff

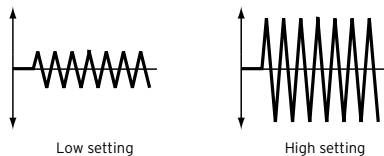

- > Use the **AMS** pop-up menus to select a modulation source for the LFO Intensity volume of the amp for the selected oscillator.

The **Intensity** parameter (-99...+99) specifies the depth and direction of the AMS.

Programming the amplitude envelope (Amp EG)

You can create time-varying changes in the volume of the selected oscillator.

- > Go to the **Sound Edit > Menu > Amp > Envelope Generator** page.

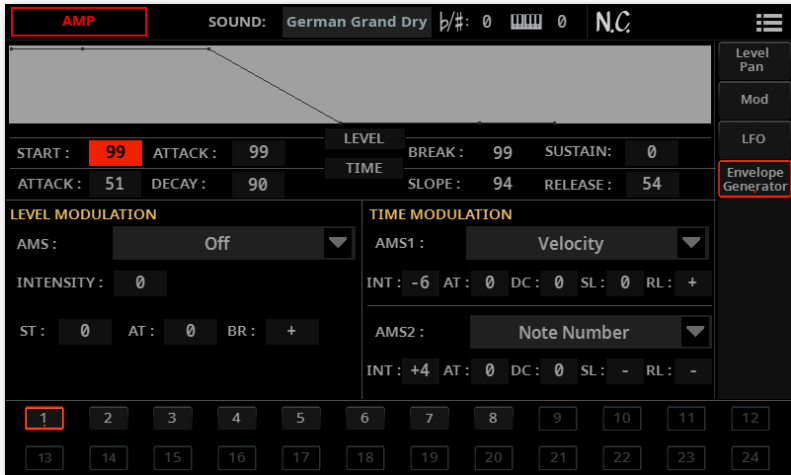

The diagram on top of the page shows the Amplitude envelope line.

Setting the Amp EG levels and times

Amp EG can be programmed by setting the **Level** and **Time** parameters of the envelope segments.

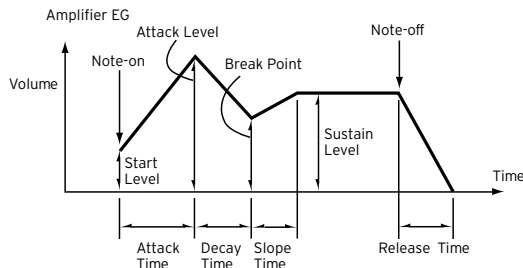

- > Use the **Level** parameters (-99...+99) to specify the volume level that will be reached at the end of the segment.

EG Level	Meaning
Start	Volume level at note-on. If you want the note to begin at a loud level, set this to a high value.
Attack	Volume level that will be reached after the attack time has elapsed.
Break (Break Point)	Volume level that will be reached after the decay time has elapsed.
Sustain	Volume level that will be maintained from after the slope time has elapsed until note-off occur.

- > Use the **Time** parameters (0...99) to specify the time over which the volume level is reached.

EG Time	Meaning
Attack	Time over which the volume will change after note-on until it reaches the attack level. If the start level is 0, this will be the rise time of the sound.
Decay	Time over which the volume will change from when it reaches the attack level until it reaches the break point level.
Slope	Time over which the volume will change from when it reaches the break point level until it reaches the sustain level.
Release	Time over which the volume will change after note-off until it reaches 0.

Modulating the Amp EG

■ Modulating the Amp EG levels

- > Use the **Level Modulation > AMS** parameter to select a modulation source for the Level parameters of the Amp EG.
- > Use the **Level Modulation > Intensity** parameters (-99...+99) to specify the depth and direction of the **AMS**.

For example, if the AMS is Velocity, setting St (Start Level Swing), At (Attack Level Swing) and Br (Break Point Level Swing) parameters to + and setting Intensity to a positive (+) value, will cause the amp EG volume levels to increase as you play harder. Setting Intensity to a negative (-) values will cause the amp EG volume levels to decrease as you play harder. With a value of 0, the levels will be as specified on Level parameters.

- > Use the **St (Start Level Swing)**, **At (Attack Level Swing)** and **Br (Break Level Swing)** parameters to specify the direction in which AMS will affect the Level > Start, Attack and Break Point levels.

When Intensity has a positive (+) value, a setting of + for this parameter will allow the AMS to raise the EG level, and a setting of - will allow AMS to lower the EG level. With a value of 0 there will be no change.

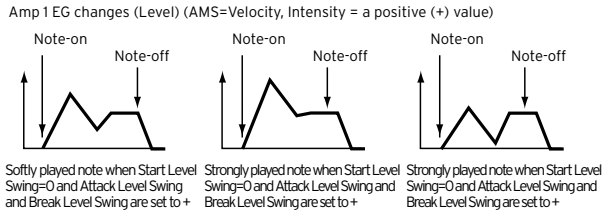

■ Modulating the Amp EG times

- > Use the **Time Modulation > AMS 1/2** parameters to select a modulation source for the Time parameters of the Amp EG.
- > Use the **Time Modulation > Intensity** parameters (-99...+99) to specify the depth and direction of the effect that the AMS will have on the Time parameters. With a value of 0, the Amp EG times will be just as specified by the Time settings.

For example, if the AMS is Amp KTrk +/+, the (Amp) Keyboard Track settings (in the **Edit Sound > Amp > Mod** page) will control the EG Time parameters. With positive (+) values of this parameter, positive (+) values of Ramp (Ramp Setting) will cause EG times to be lengthened, and negative (-) values of Ramp (Ramp Setting) will cause EG times to be shortened. The direction of the change is specified by the At (Attack Time Swing), Dc (Decay Time Swing), SI (Slope Time Swing), and RI (Release Time) parameters.

If the AMS is set to Velocity, positive (+) values of this parameter will cause EG times to lengthen as you play heavily, and negative (-) values will cause EG times to shorten if you play heavily. With a value of 0, the EG times will be as specified by the Level parameters.

- > Use the **At (Attack Time Swing)**, **Dc (Decay Time Swing)**, **SI (Slope Time Swing)** and **RI (Release Time Swing)** parameters to specify the direction in which the AMS will affect the Time > Attack, Decay, Slope and Release parameters.

With positive (+) values of Intensity, a setting of + will cause the time to be lengthened, and a setting of - will cause the time to be shortened. With a value of 0 there will be no change.

Amp 1 EG changes (Time)

(AMS=Amp K Trk +/-, Intensity = a positive (+) value)

(When Amp Keyboard Track "Low Ramp" = a positive (+) value, and

"High Ramp" = a positive (+) value)

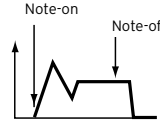
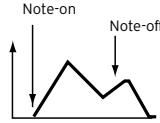
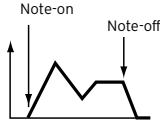

Low-pitched note played with Attack, Decay, Slope, and Release Time Swing at +

High-pitched note played with Attack, Decay, Slope, and Release Time Swing at -

Amp 1 EG changes (Time) (AMS= Velocity, Intensity= a positive (+) value)

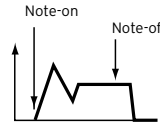
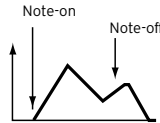
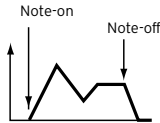

Softly played note with Attack, Decay, Slope and Release Time Swing at +

Strongly played note with Attack, Decay, Slope and Release Time Swing at +

Strongly played note with Attack, Decay, Slope and Release Time Swing at -

Programming the LFO

LFO (Low Frequency Oscillation) can be used to cyclically modulate the Pitch, Filter, and Amp of each oscillator. There are two LFO units for each oscillator (**LFO 1** and **LFO 2**).

> Go to the **Sound Edit > Menu > LFO > LFO 1** or **LFO 2** page, depending on the LFO to program.

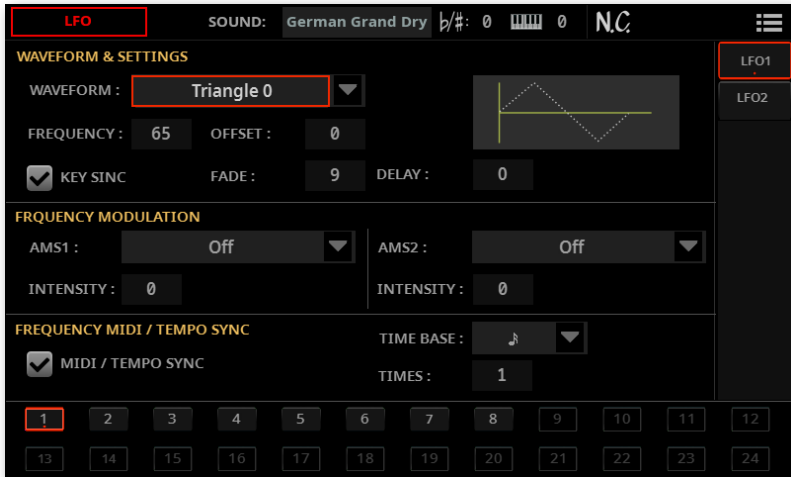

Choosing the LFO waveform and settings

You can choose the LFO waveform, program it and synchronize it.

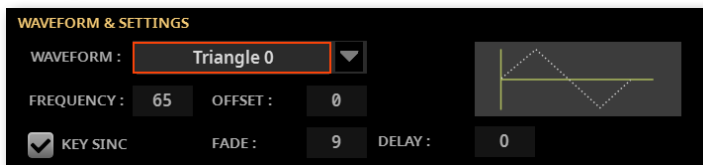

■ Choosing the LFO waveform and frequency

> Use the **Waveform** parameter to choose the LFO waveform. The numbers appearing on the right of some of the LFO waveforms indicate the phase at which the waveform will begin.

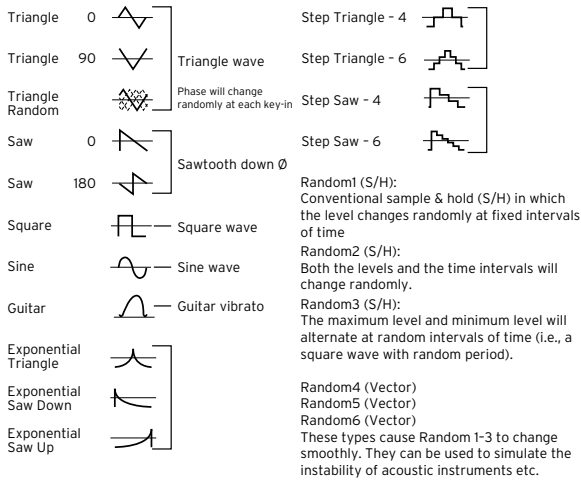

> Use the **Frequency** parameter to set the LFO frequency (00...99). This parameter adjusts the speed of the vibrato.

> Use the **Offset** parameter to specify the central value of the LFO waveform.

For example, with a value of 0 as shown in the following diagram, the vibrato that is applied will be centered on the note-on pitch. With a value of +99, the vibrato will only raise the pitch above the note-on pitch, in the way in which vibrato is applied on a guitar.

When the Waveform is Guitar, the modulation will occur only in the positive (+) direction even if you set the Offset to 0.

Here are offset settings and pitch change produced by vibrato:

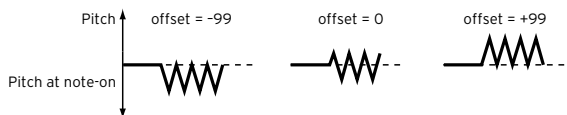

■ Synchronizing the LFO with the key press

- > Select the **Key Sync** checkbox to synchronize the LFO to the key presses.

Key Sync	Meaning
On	The LFO will restart each time you play a note, and an independent LFO will operate for each note.
Off	The LFO effect that was started by the first-played note will continue to be applied to each newly-played note. (In this case, Delay and Fade will be applied only to the LFO when it is first started).

■ Fading the LFO

- > Use the **Fade** parameter (00...99) to specify the time elapsed from the LFO start to its maximum amplitude. When Key Sync is Off, the fade will apply only when the LFO is first started.

Here is how Fade affects the LFO (when Key Sync is On):

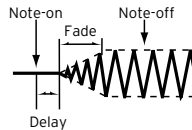

■ Delaying the LFO

- > Use the **Delay** parameter (0...99) to specify the time elapsed from note-on to the LFO starting to apply. When Key Sync is Off, the delay will apply only when the LFO is first started.

Fading vibrato is typical of wind instruments, where vibrato enters gradually.

Modulating LFO frequency

Use the **Frequency Modulation** parameters to set the two alternate modulation sources to adjust the speed of the LFO for the selected oscillator.

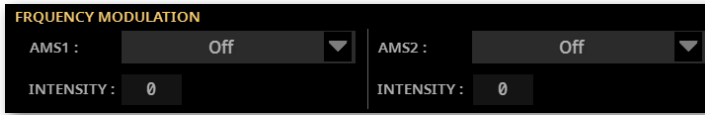

- > Use the **AMS 1/2** pop-up menus to choose the modulation sources that will adjust the frequency of the selected oscillator's LFO. LFO 1 can be modulated by LFO 2.
- > Use the **Intensity** parameters (-99...+99) to set the modulation depth and direction.

This parameter specifies the depth and direction of the effect that the AMS will have. When this parameter is set to a value of 16, 33, 49, 66, 82, or 99, the LFO frequency being can be increased by a maximum of 2, 4, 8, 16, 32, or 64 times respectively (or decreased by 1/2, 1/4, 1/8, 1/16, 1/32, or 1/64 respectively).

For example, if the AMS is Note Number, positive (+) values of this parameter will cause the oscillator LFO to speed up as you play higher notes. Negative (-) values will cause the oscillator LFO to slow down as you play higher notes. This change will be centered on the C4 note.

If the AMS is set to JS +Y, raising the value of this parameter will cause the oscillator LFO 1 speed to increase as the joystick is moved away from yourself. With a value of +99, moving the joystick all the way away from yourself will increase the LFO speed by approximately 64 times.

Synchronizing the LFOs

Use the **Frequency MIDI/Tempo Sync** parameters to synchronize the LFO to the Player's Tempo.



- > Select the **MIDI/Tempo Sync** checkbox to synchronize the LFO to the Player's Tempo. The values specified in Frequency and Frequency Modulation will be ignored.
- > Use the **Time Base** pop-up menu to choose a note length, and the **Times** parameter to choose a multiple of it. This will be the LFO frequency.

For example if the Time Base is \downarrow (quarter note) and Times is 04, the LFO will perform one cycle every four beats.

These parameters are not available when editing a Drum Kit.

Adding effects to the Sound

You can send the Sound to the effects of the FX B Group (usually reserved to the Keyboard Sounds).

- > Go to the **Sound Edit > Menu > Effects > Effects** page.



Activating and choosing the effects

Each Sound can go into the insert and master effect processors. These settings are usually overridden, for example, by the Keyboard Set or Style's own effects.

These insert effects will, however, be used when the **Use IFX** option is selected in the **page menu** (☰) of the **Sound Select** window before choosing a Sound.

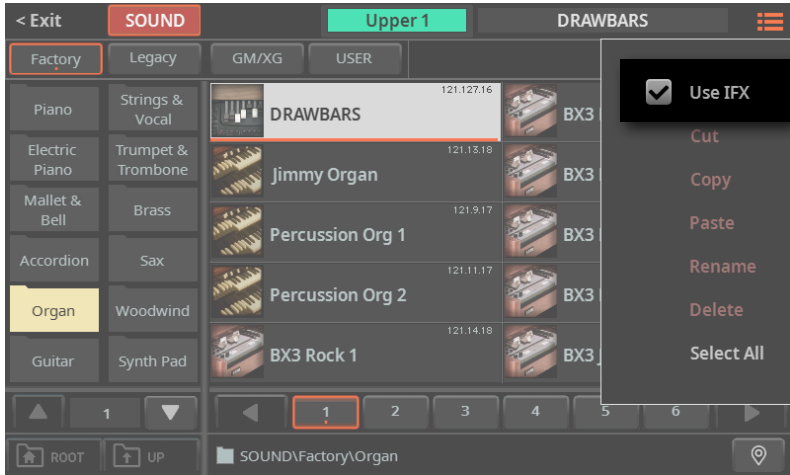

■ Activate the effects

- > Use the **On/Off** buttons to turn on or off the corresponding effect.

■ Choose the effects

- 1 Touch the **name of the effect** to open the **FX Edit** page.

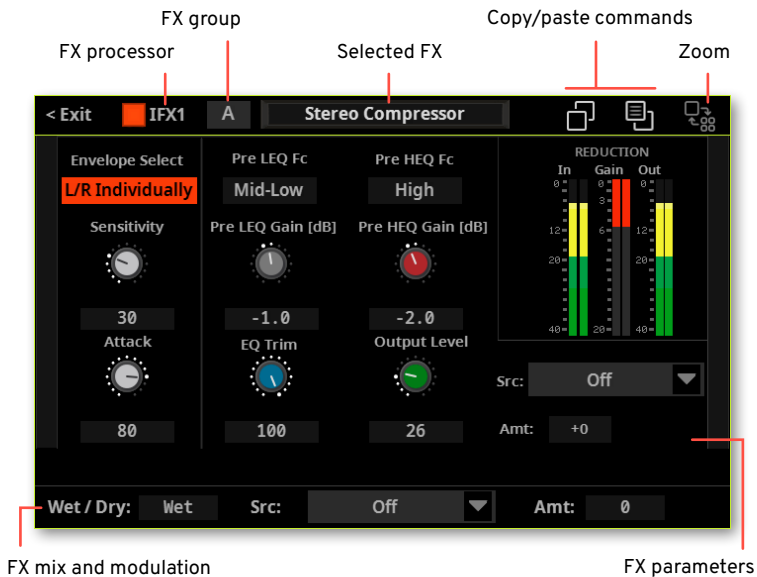

- 2 Touch the **name of the selected effect** on top of the dialog to open the **FX Select** window, and choose an effect.
- 3 If needed, edit the various parameters, as described in the part of the User Manual dedicated to the [Effects for the Sounds](#).
- 4 You can adjust the **Wet/Dry** mix of the effects. With master effects, you can use either the **Send Level** knobs in this page, or the individual mixer channels' send level for mixing the dry and wet signals.
- 5 When finished editing, press the **EXIT** button to return to the previous page.

Setting the effect parameters

All the parameters in this page are the same seen in the Mixer section. Please check [The Insert and Master Effects](#) on page 360.

- > Use the **Send Level** knobs (0...127) next to the Master Effects to set the level of the Sound going to the effect.

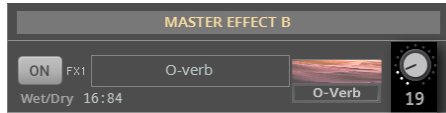

- > Use the **Routing > Send to FX1** knobs to route the corresponding master effect back to the input of Master FX1, and create a serial effect chain.

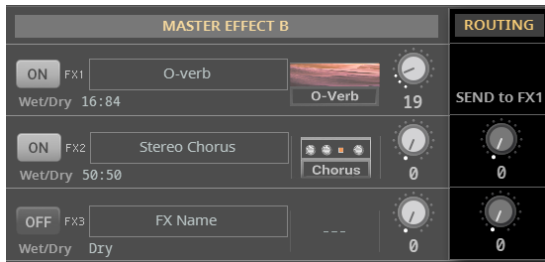

- > Select the **Direct Signal** checkbox to add the dry signal to the effected signal. If this is not selected, only the effected signal will be heard.



Sound Edit utilities

In the **page menu** (☰) you can find utilities to be used while programming.

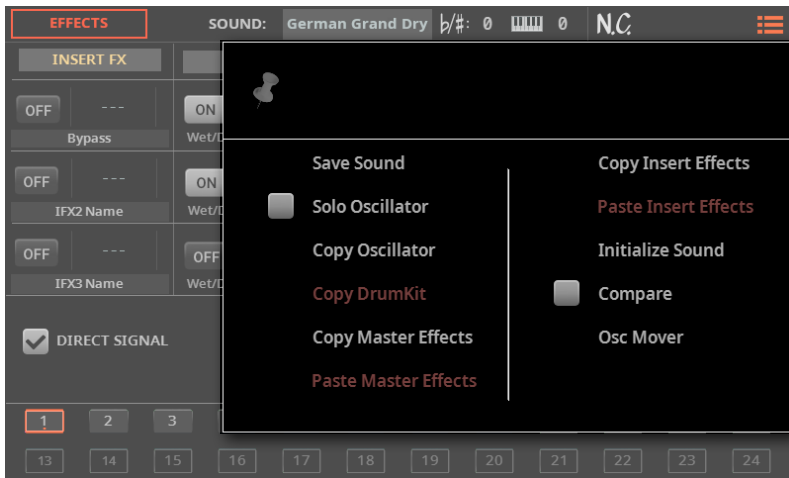

Listening to a single oscillator

- > Check the **Solo Oscillator** item in the **page menu** (☰) to solo the selected oscillator, and mute the other oscillators.
- > Uncheck it to unmute all the oscillators.

When this function is activated, the **Solo [n]** indicator (n = oscillator number) blinks on the title bar. While in this situation, you can select a different oscillator to be soloed.

Copying the oscillators

You can copy all the settings of an oscillator onto the other oscillators.

- 1 Choose the **Copy Oscillator** command from the **page menu** (☰). The **Copy Oscillator** dialog will appear.

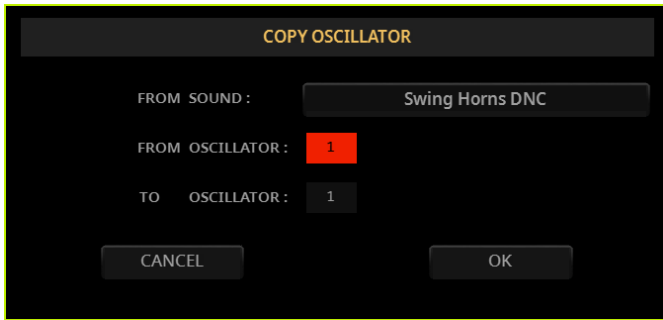

- 2 Touch the **From Sound** button to open the **Sound Select** window, and choose the source Sound.
- 3 Use the **From Oscillator** parameter to choose the source oscillator to copy from.
- 4 Use the **To Oscillator** parameter to choose the target oscillator where to copy the source settings onto.
- 5 Touch the **OK** button to confirm.

Copying Drum Kits

You can copy the kit of percussive instruments from a different Drum Kit.

- 1 Choose the **Copy Drum Kit** command from the **page menu** (☰). The **Copy Drum Kit** dialog will appear.

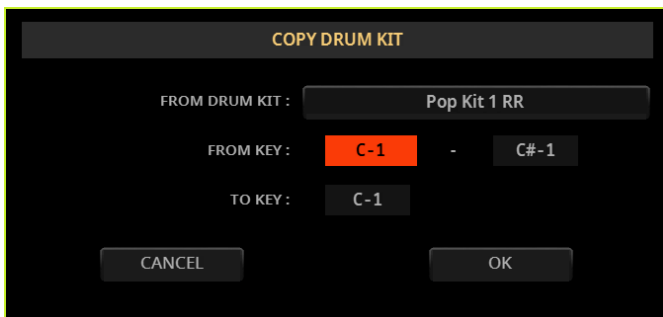

- 2 Touch the **From Drum Kit** button to open the **Sound Select** window, and choose the source Drum Kit.
- 3 Use the **From Key** parameters to choose the range of keys to copy from.
- 4 Use the **To Key** parameter to choose the key from which to start copying.
- 5 Touch the **OK** button to confirm.

Copying the effects

To speed up programming, you can copy the effects to a different Sound.

- 1 Choose the Sound which effects you want to copy.
- 2 Choose the **Copy Master Effects** and/or **Copy Insert Effects** command from the **page menu** (☰) to copy the corresponding effects.
- 3 Choose the Sound where you want to paste the effects.
- 4 Choose the **Paste Master Effects** and/or **Paste Insert Effects** command from the **page menu** (☰) to paste the corresponding effects.

Initializing a Sound

- > Choose the **Initialize Sound** command from the **page menu** (☰) to delete all parameters, and reset them to a default value.

Comparing with the original Sound

You can compare the Sound you are editing with the original Sound.

- > Check the **Compare** item in the **page menu** (☰) to listen to the original Sound.
- > Uncheck this item to recall the Sound in edit.

While this function is on, the **Compare** indicator blinks on the page header. You cannot edit the Sound while you are in Compare mode.

Moving and rearranging the oscillators

You can move the oscillators to a different position, to rearrange them in the way you prefer.

1 Choose the **Osc Mover** command from the **page menu** (☰). The **Osc Mover** window will appear.

Osc	MS H	MS H Name	MS L	MS L Name	Vel Range	Trg Event	Trg Cond
1	1634	BB Trumpet PVib ff	1633	BB Trumpet PVib f	106-125	N.On	Not Legal
2	1632	BB Trumpet PVib mf	1631	BB Trumpet PVib p	1-105	N.On	Not Legal
3	1634	BB Trumpet PVib ff	1633	BB Trumpet PVib f	106-125	N.On	Legato
4	1632	BB Trumpet PVib mf	1631	BB Trumpet PVib p	1-105	N.On	Legato
5	1641	BB Trumpet Falls Long	1652	BB Trp Plung Wah mf	126-127	N.On	Normal
6	373	Classic Trumpet f	372	Classic Trumpet p	1-127	N.On	Legato
7	1636	BB Trumpet Up4	1618	BB Trmb PVib mf	1-127	N.On	Legato Uj
8	1637	BB Trumpet Dw4	1618	BB Trmb PVib mf	1-127	N.On	Legato Dc
9	1645	BB Trumpet Up8	1618	BB Trmb PVib mf	1-127	N.On	SC1
10	1641	BB Trumpet Falls Long	392	Trumpet Fall	1-127	N.Off(VOn)	SC1
11	1646	BB Trumpet Dw8	1618	BB Trmb PVib mf	1-127	N.On	SC2
12	1642	BB Trumpet Falls Short	392	Trumpet Fall	1-127	N.Off(VOn)	SC2
13	1647	BB Trumpet Shakes	391	Trumpet Doit	1-127	N.On	SC3
14	1653	BB Trp Plung Wah Growl	1652	BB Trp Plung Wah mf	1-127	N.On	SC Joy Y-
15	1658	BB Trp Noise Atk	1252	Empty	1-127	N.On	Not Legal
16	1658	BB Trp Noise Atk	1252	Empty	1-127	N.On	Normal
17	1659	BB Trp Sus Breath	1252	Empty	1-127	N.On	Normal

MOVE OSCILLATOR	1	TO POSITION	1	MOVE	EXIT
-----------------	---	-------------	---	------	------

While in this window you can see the following information on each of the oscillators.

Parameter	Meaning
Osc	Oscillator number
MS H	Number of the High Multisample
MS H Name	Name of the High Multisample
MS L	Number of the Low Multisample
MS L Name	Name of the Low Multisample
Vel Range	Velocity range
Trg Event	Event triggering the oscillator
Trg Cond	Condition triggering the oscillator (as determined by the Trigger Mode parameters in the Sound Edit > Menu > Basic > Oscillator page)

- 2** Use the **Move Oscillator** parameter to select the oscillator to be moved.
- 3** Use the **To Position** parameter to select the target position.
- 4** Touch the **Move** button to swap the source and target oscillators, then confirm.
- 5** When done, touch the **Exit** button to close the window.

Saving the Sounds

After editing, you can save all the edited parameters into a User Sound location in memory.

NOTE: Changes can only be saved onto User Sounds.

1 While in **Sound Edit** mode, choose the **Save Sound** command from the **page menu** (☰) to open the **Save Sound** dialog.

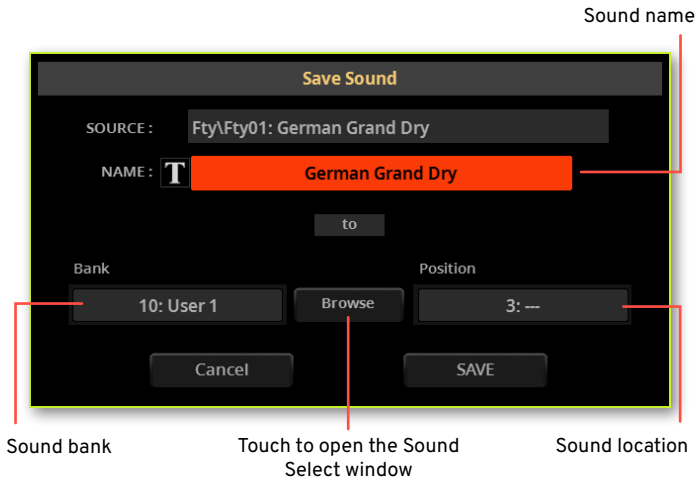

2 You may change the **name** of the Sound. Touch the **Text Edit** (T) button to open the **virtual keyboard** and edit the name.

When done editing the name, confirm by touching the **OK** button under the virtual keyboard.

3 When back at the **Save Sound** dialog, if you want to save onto a different location touch the **Browse** button and open the **Sound Select** window. The Sounds are organized in a rigid grid. Choose a location as if you were choosing a Sound. Blank locations are shown as a series of dashes ('---').

4 When back at the **Save Sound** dialog, confirm the Save operation by touching the **Save** button.

CAUTION: If you write over an existing Sound, the existing Sound will be deleted. Please save on a storage device any User Sound you don't want to lose.

AMS (Alternate Modulation Sources)

When the AMS abbreviation is encountered, an Alternate Modulation can be applied to the corresponding parameter. Alternate Modulation allows for realtime control of the effect. The following table shows the available modulation sources.

AMS	Description	Note
Off	Do not use Alternate Modulation	
Pitch EG	Pitch EG	
Filter EG	Filter EG within the same oscillator	
Amp EG	Amp EG within the same oscillator	
LFO1	LFO1 within the same oscillator	
LFO2	LFO2 within the same oscillator	
Flt KTrk +/+	Filter keyboard tracking within the same oscillator	+/- The direction of the effect will be determined by the sign (positive or negative) of the Ramp Low or Ramp High setting.
Flt KTrk +/-		
Flt KTrk 0/+	Amp keyboard tracking within the same oscillator	+/- The direction of the effect will be determined by the sign of the Ramp Low setting, and by the opposite sign of the Ramp High setting (50 for a setting of +50, and +50 for a setting of 50). 0/+ Ramp Low will have no AMS effect. The sign of the Ramp High setting will determine the direction of its effect. +/- The sign of the Ramp Low setting will determine the direction of its effect. Ramp High will have no AMS effect.
Flt KTrk +/-0		
Amp KTrk +/+		
Amp KTrk +/-		
Amp KTrk 0/+		
Amp KTrk +/-0		
Note Number	Note number	
Velocity	Velocity	
Poly AT	Polyphonic After Touch (received/transmitted via MIDI or contained in Standard MIDI Files)	
Channel AT	After Touch (Channel After Touch)	
Joystick X	Joystick X (horizontal) axis	
Joystick +Y	Joystick +Y (vertical upward) direction (CC#01)	
Joystick -Y	Joystick -Y (vertical downward) direction (CC#02)	

AMS	Description	Note
JS+Y & AT/2	Joystick +Y (vertical upward) direction and After Touch	The effect will be controlled by the joystick +Y (vertically upward) and by after touch. In this case, the effect of after touch will be only half of the specified intensity.
JS-Y & AT/2	Joystick Y (vertical downward) direction and After Touch	The effect will be controlled by the joystick Y (vertically downward) and by after touch. In this case, the effect of after touch will be only half of the specified intensity.
Assign. Pedal	Assignable foot pedal (CC#04)	
Ribbon Ctl.	Ribbon controller (CC#16)	
CC#18	CC#18	
CC#17	CC#17	
CC#19	CC#19	
CC#20	CC#20	
CC#21	CC#21	
CC#17 [+]	CC#17 positive values only	
CC#19 [+]	CC#19 positive values only	
CC#20 [+]	CC#20 positive values only	
CC#21 [+]	CC#21 positive values only	
Damper	Damper pedal (CC#64)	
CC#65	Portamento switch (CC#65)	
Sostenuto	Sostenuto pedal (CC#66)	
CC#80	Sound Controller 1 (CC#80)	
CC#81	Sound Controller 2 (CC#81)	
CC#82	General Purpose #7 (CC#82)	
CC#83	General Purpose #8 (CC#83)	
Tempo	Tempo value from Player 1 or external MIDI clock	
Velocity Plus	Key On and Key Off Velocity are used	
Velocity Exp	Velocity with Exponential curve (higher velocity notes are even louder)	
Velocity Log	Velocity with Logarithmic curve (higher velocity notes are weaker than with the linear Velocity)	

Diagrams of the **AmpKTrk** sources follow.

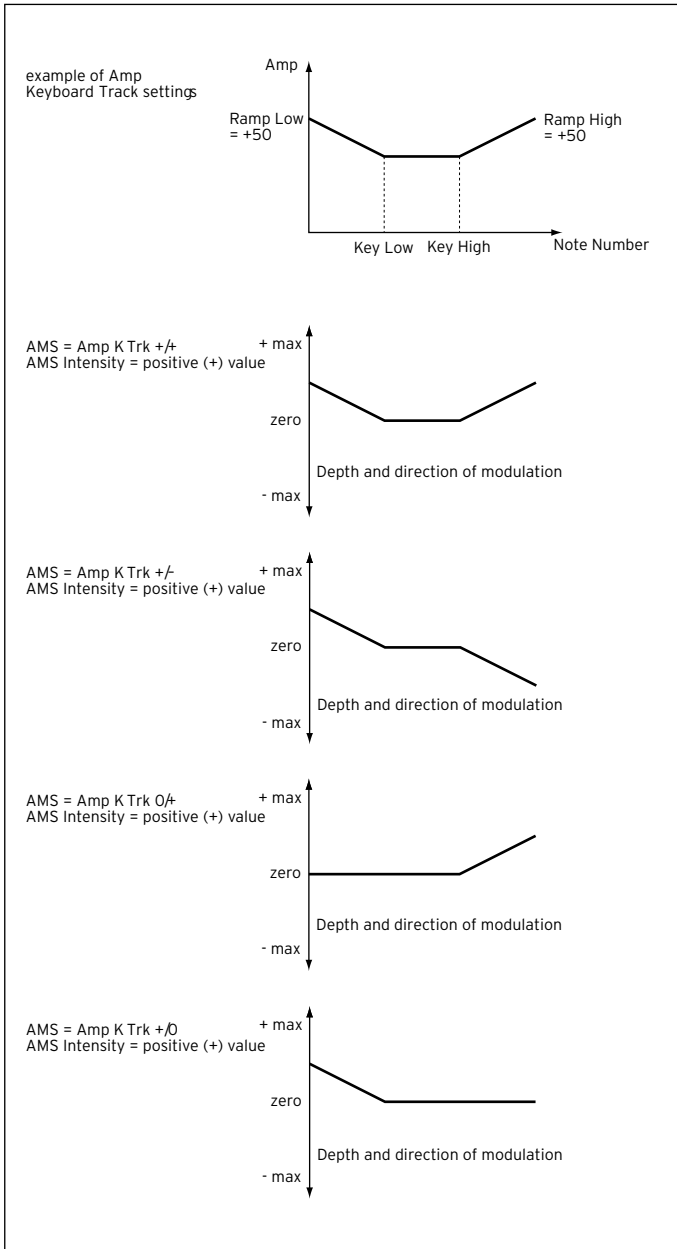

32

Editing the Samples

Making new sounds with Sampling

Creating new Sounds or Audio Grooves

Pa5X includes a full-featured sampler, that allows you to create new Samples, new Multisamples and new synced Audio Grooves. In addition to recording, you can load Samples, Multisamples, Sounds and banks of Sounds from various formats.

Creating new ordinary or percussive Sounds

Sampling allows you to create new sounds, by recording from an external source (for example, a microphone or a CD or media player) connected to Pa5X's audio inputs, or by loading files from a storage device.

To be used, Samples must then be assigned to a Multisample or a Drum Kit. A Multisample allows you to arrange samples into separate zones of the keyboard. Drum Kits allows you to assign a different sample to each note of the keyboard, with up to six dynamic layers per note and up to four round-robins.

Multisamples can then be assigned to Sounds. Sounds created with this function can be used as any ordinary Sound, and assigned to any part/track.

Creating Audio Grooves

Another powerful feature of the Sampling mode is the Time Slice, that lets you add realism to MIDI tracks by creating Audio Grooves. Cycling rhythm samples, usually named 'audio grooves', can be 'sliced' into separate percussive instruments. Combined with MIDI tracks, the 'sliced' audio groove can be kept in sync with the Tempo, and can play slower or faster than the original groove.

Accessing the Sample Edit mode

- 1 Press the **REC/EDIT** button on the control panel to see the **Record/Edit** menu.

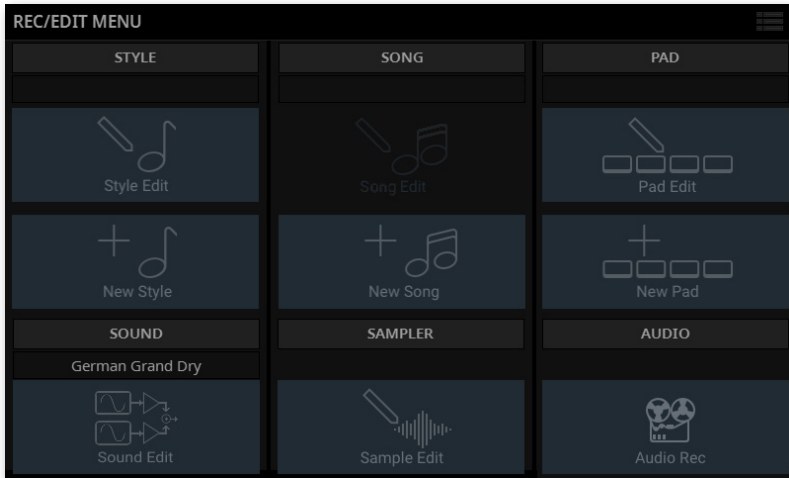

- 2 Touch the **Sample Edit** button in the menu. The **main page** of the **Sample Edit** mode will appear.

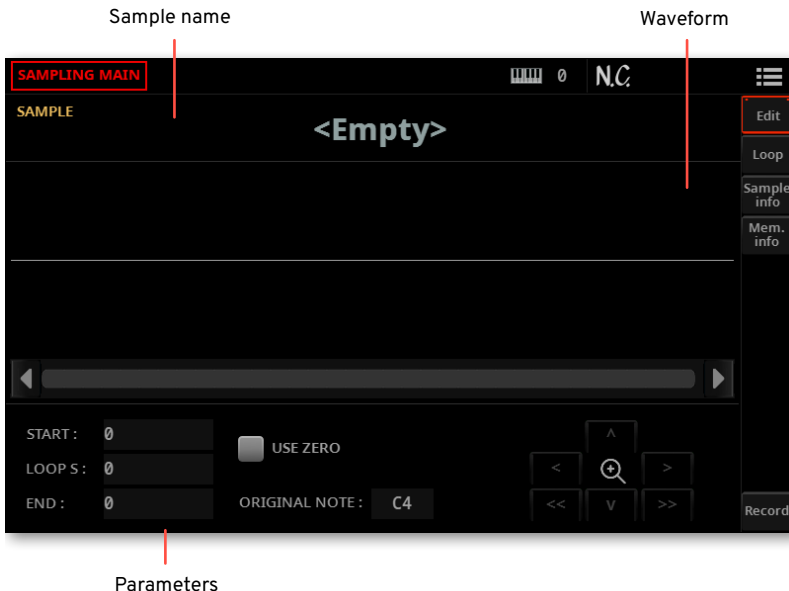

Please note that no sound will be heard when you first enter Sampling mode.

3 Press the **MENU** button on the control panel, and touch one of the buttons to choose the corresponding **edit section** of the **Sound Edit** mode.

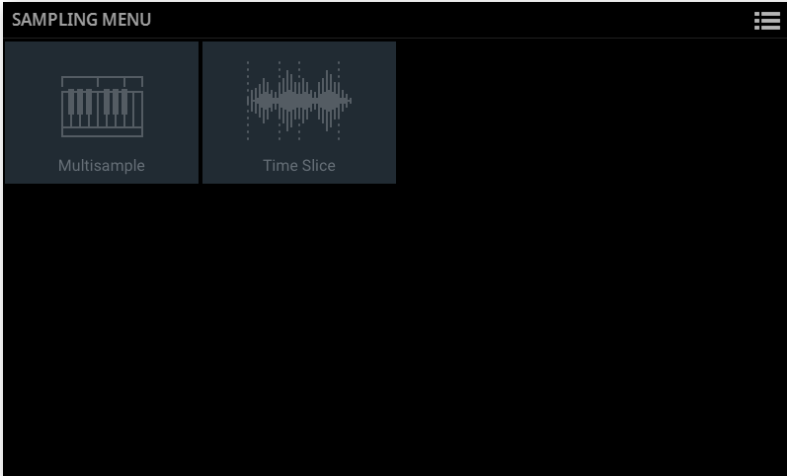

4 Press the **EXIT** button on the control panel to return to the **main page** of the **Sample Edit** mode.

5 To exit from the **Sample Edit** mode, press the **EXIT** or the **REC/EDIT** button again. In case there are unsaved data, a message will warn you.

Loading samples and multisamples

Loading samples from a drive

Supported Sample formats

You can load samples in the following formats.

Sample format	Meaning
KSF	KORG's native sample format, used by the Pa-Series arrangers, and with their legacy in the Trinity and Triton series of workstations. File names must have the .ksf extension. You can load both compressed and uncompressed samples.
AIFF	Apple Mac's preferred format for audio. File names must have the .aif extension.
WAVE	Microsoft Windows preferred format for audio. File names must have the .wav extension.

You can load samples (mono or stereo) in a 8 or 16-bit resolution, and a sampling frequency rate from 11,025 to 48,000Hz. Loaded samples always preserve their original resolution.

If the sample exceeds the maximum size allowed (1,048,576 samples, corresponding to 1 Megasample, either mono or stereo), it will be truncated. A warning will appear in the display.

Please be aware that, by loading new samples, the sample currently in edit will be lost if not saved. Before loading, use the **Write** command to save the sample in edit, if not yet saved.

As an alternative to loading individual samples, you can import sounds or multisamples and their assigned samples, as described later in this chapter.

Loading a sample

1 While in the **Sample Edit > Main > Edit** page, choose the **Load Sample** command from the **page menu** (☰), to open the **Load Sample** window.

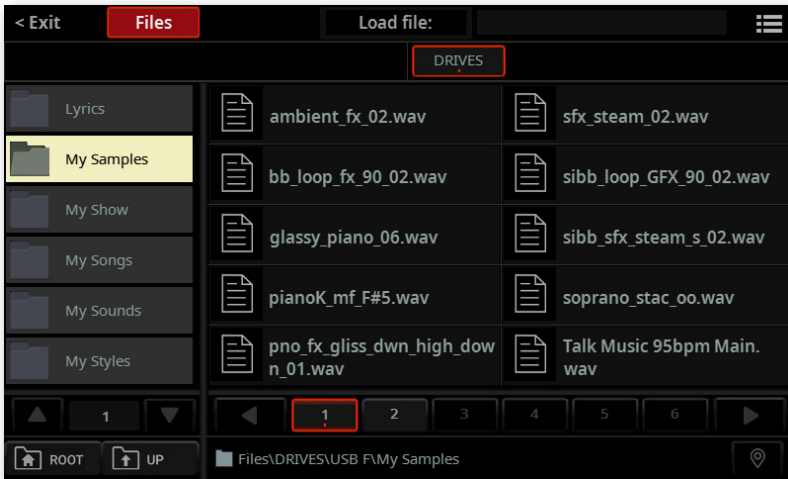

2 Browse through the files, then select the sample to load, and choose the **Load** command from the **page menu** (☰). The sample will be loaded in the sample editor.

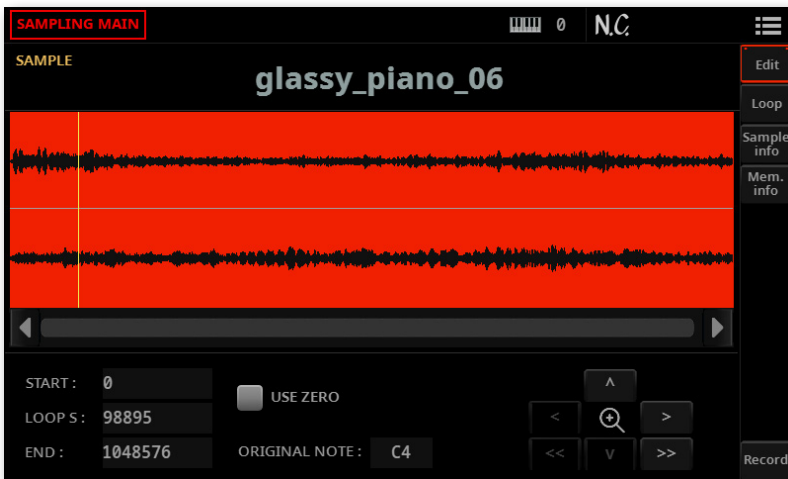

3 After loading a sample, you can edit it in the other pages of the **Sample Edit** section. If it is an Audio Groove, continue editing it with the **Time Slice** function (see later).

4 After having loaded a sample, choose the **Save** command from the **page menu** (☰), to open the **Save Sample** window and save the sample into the internal User Sample memory.

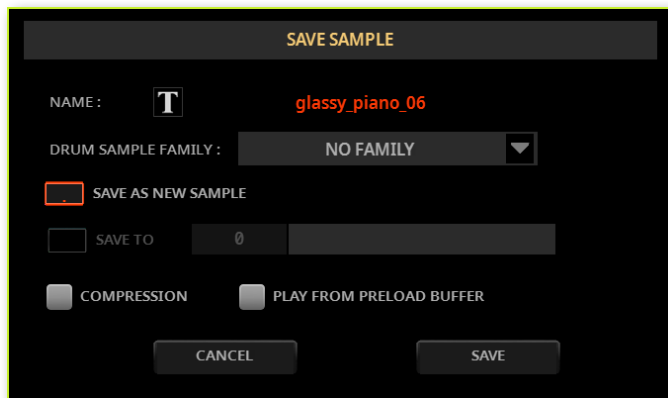

5 Be sure the the **Save as new sample** option is selected, and touch the **Save** button to save the sample.

To create a new User Sound, load or record more samples, save them into the internal User Sample memory, then join them into a multisample (as described later in this chapter). Then use the multisample into a User Sound (as described in the chapter dedicated to the **Sound Edit** pages).

Choosing a sample from the internal sample memory

Before editing, you can choose one of the samples you saved into the internal User Sample memory.

- 1 While in the **Sample Edit > Main > Edit** page, touch the name of the sample in edit, and open the **Sample Select** window.

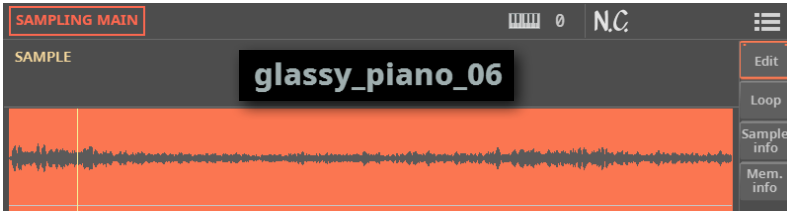

- 2 While in the **Sample Select** window, scroll through the samples, then touch the one you want to select and edit.

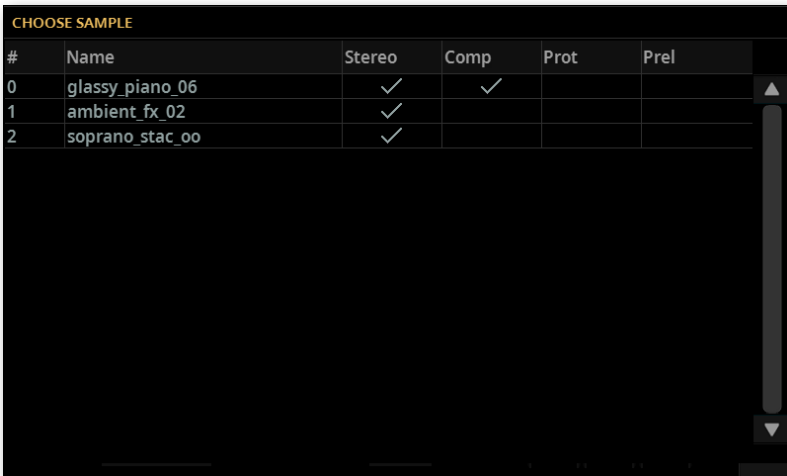

This window contains various information about the samples in memory.

Parameter	Meaning
#	Progressive number of the sample.
Name	Name of the sample.
Comp	When the checkmark appears, the sample is compressed. You can enable/disable compression when writing the sample (in the Save Sample dialog).
Prot	When the checkmark appears, the sample is copy protected. Be sure the protection key was inserted when turning the instrument on, or you will not be able to use the protected data. If you forgot to do it, insert the protection key and restart the instrument.
Prel	When the checkmark appears, the sample contains the 'Play from Preload Buffer' flag, and will be entirely loaded into memory. You can enable/disable this flag when writing the sample (in the Save Sample dialog). This type of sample can't be compressed.

3 If you want to exit from this window without selecting anything, press the **EXIT** button.

Importing Sounds or multisamples

Supported Sounds and Multisample formats

You can import Sounds and Multisamples (including the contained samples) in formats other than the native Pa-Series format.

You can import the following file formats.

File format	Meaning
PCG	KORG's native Program (Sound) format, used by the Triton series of workstations. The file name has the .pcg extension. Note that Drum Kits cannot be imported.
KMP	KORG's native multisample format, used by the Trinity and Triton series of workstations. The file name has the .kmp extension.
SF2	Sound bank format by Creative Labs. The file name has the .sf2 extension. Multisample data are imported. Due to the deep differences with KORG's own format, some Instruments from the SF2 file could not be imported (for example, Instruments with overlapping zones).

Importing a Sound or multisample

1 Go to the **Sample Edit > Menu > Multisample** page, and choose the **Import** command from the **page menu** (☰) to open the **Import File** window.

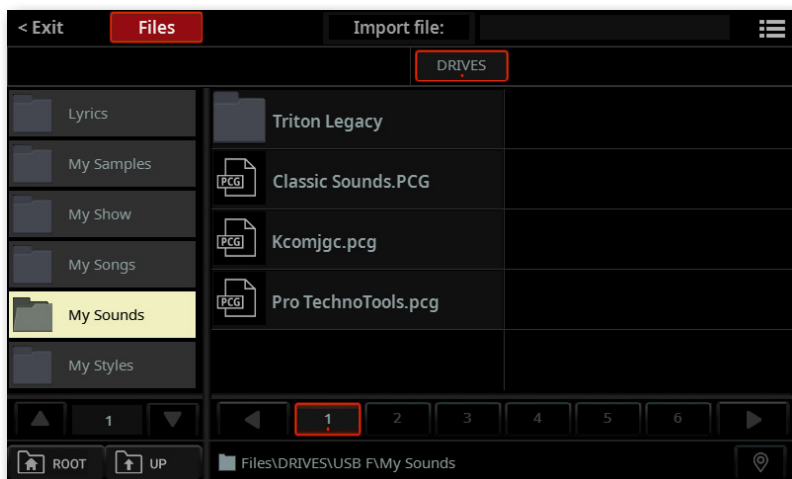

- 2 Browse through the files, then select the one to import, and choose the **Import** command from the **page menu** (☰).
- 3 If you are importing from a bank of Triton Programs, you'll be asked to choose one of the Programs it contains, and a target User Sound location where to load it.
- 4 Once the source and destination are selected, confirm by touching **OK**.

Imported Sounds, multisamples and sample are automatically stored in the internal User Sample memory, and will not be lost when turning the instrument off.

When importing a multisample, take note of its name; you will need it in Sound mode, when assigning the multisample to a new Sound.

Importing a single multisample

When importing a single multisample, you can edit its name during import.

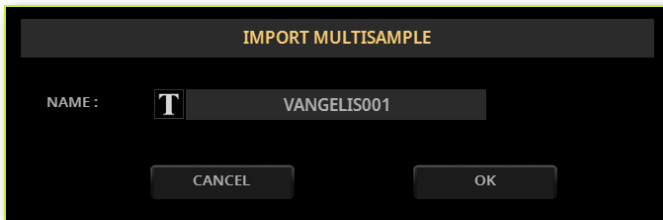

Importing PCG files

When importing a PCG file, you can choose between a single Program or a whole bank.

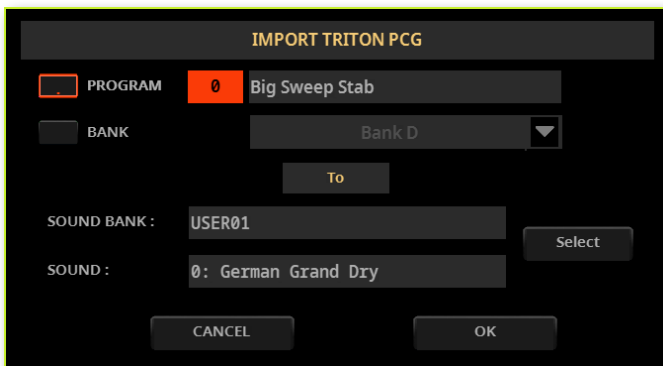

- > Choose **Program** to choose a single Program (corresponding to a Pa-Series Sound); touch the Program number and dial in the corresponding number. Choose a target Sound location where to load the imported Program.
- > Choose **Bank** to import all the Programs from the selected bank. Touch the Sound Bank name to choose a target bank where to load the imported Programs.

Due to the differences between Pa5X and the older KORG instruments, some differences may arise during conversion. When reading a PCG file, Pa5X tries to use exactly the same multisamples as in Triton. If this is not possible, it looks for a similar multisample. If this is also not possible, an <empty> multisample will be selected. Go to the Sound mode, and select a multisample suitable for the imported Program.

Not all Triton's PCG data are imported. Insert FX, EQ, Arpeggio, Combi, Global and Drum Kit data are not loaded.

Importing SF2 files

When importing an SF2 file, you can choose between a single multisample or the whole bank.

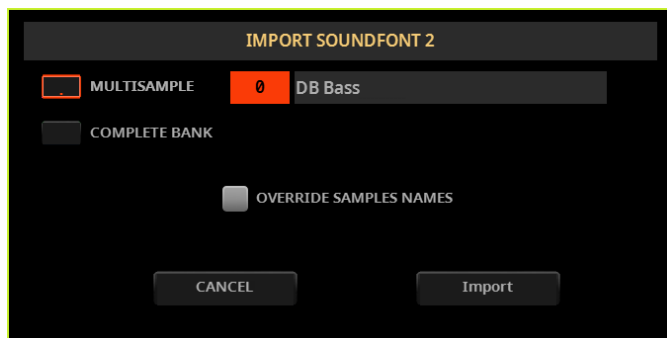

- > Choose **Multisample** to choose a single multisample (that is, SF2 Instruments); touch the multisample number and dial in the corresponding number.
- > Choose **Complete Bank** to import all the multisamples from the selected bank.

Check **Override Sample Names** if you want to assign the sample names a progressive number. In this case, when importing a multisample whose name is, for example, 'Piano', you will have all samples renamed as 'Piano_001', 'Piano_002', and so on.

Freeing memory

If you get a messages warning there isn't enough memory to load all samples or resources, choose the **Delete** command from the **page menu** (☰) to clean the User Sample memory, then retry. Please note that importing single multisamples is the safest way to avoid filling the memory with unnecessary data.

As an alternative, you can compress some or all the samples in memory, as described later in this chapter.

Recording samples or audio grooves

Connecting the audio sources and setting the levels

Connecting the audio source

- 1 To avoid harmful noises while connecting the audio inputs, set the **MASTER VOLUME** control to zero.
- 2 Connect the source to be recorded (for example, a microphone or an external player) to the relevant audio input(s) on the rear of the instrument.

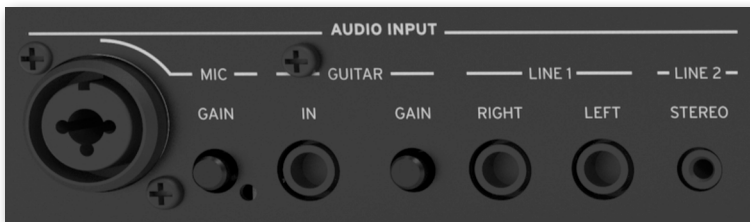

- 3 Go to the **Settings > Menu > Audio/Video > Audio In** page to set the signal routing for the input source.

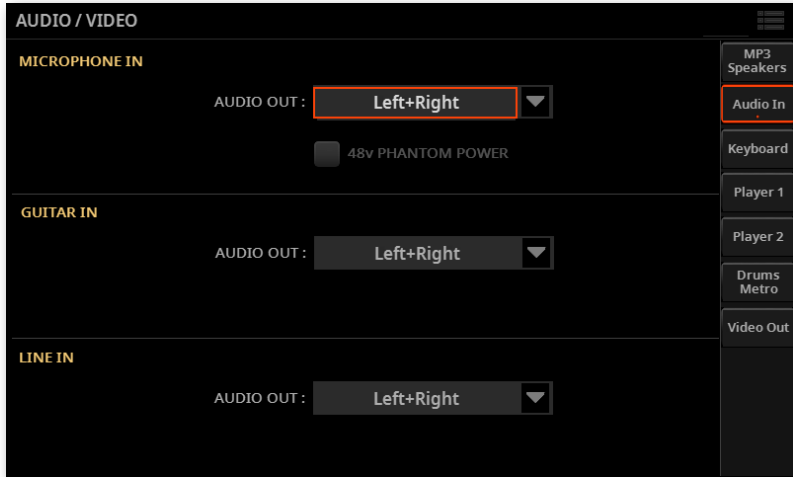

- 4 Select the **48V Phantom Power** checkbox to enable the phantom power, in case a condenser microphone has been connected.
- 5 When the source has been connected, move the **MASTER VOLUME** control to a position other than zero.
- 6 Press the **EXIT** button to return to the previous page.

Accessing the Sample Record page

> While in the main page of the **Sample Edit** mode, touch the **Record** tab to go to the **Sample Edit > Main > Record** page.

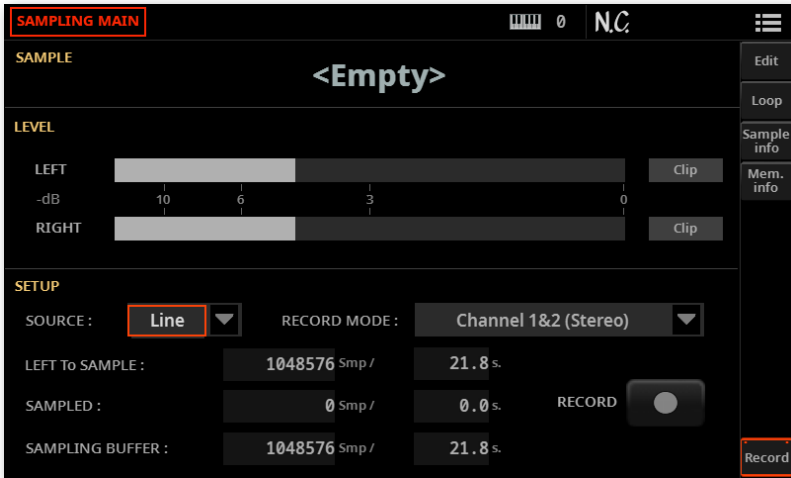

Enabling the audio source and adjusting the levels

- 1 While in the **Sample Edit > Main > Record** page, use the **Source** pop-up menu to choose the input source.
- 2 If you are recording from the line inputs, use the **Record Mode** pop-up menu to choose one or both stereo channels.
- 3 Adjust the source's volume. If you are recording with a microphone or guitar, use the corresponding **GAIN** knob of the back of the instrument. If you are sampling from a line source (like an external player or another instrument), set the source's own output level. If possible, set the output level of the source to be sampled to the maximum.

Watch at the meters in the display to check the input level. The better level is between -3dB and 0dB. Ideally, you should never go to 0dB. When the **Clip** indicators turn red, the signal is too hot and is clipping (distorting).

Should clipping happen, the **Clip** indicators would turn red. Touch one of them to reset these indicators.

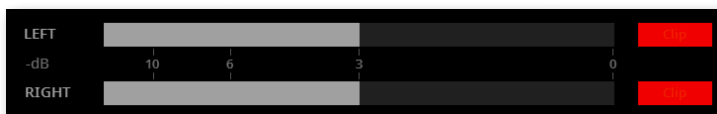

Recording

Recording a sample

Next, you'll record the sound or audio groove.

1 If you can, first start the source to be recorded, then touch the **Record** (●) button in the display to start recording.

As an alternative, touch the **Record** (●) button in the display, and immediately start the source to be recorded. In any case, you will be able to remove the initial part of the sample after recording, by moving forward the **Start** point.

Sampling will happen at 16 bit, 48 kHz.

2 Touch the **Record** (●) button in the display again to stop recording. When the memory is full, the sampling automatically stops. A maximum of 21.8 seconds is allowed for each sample.

3 Go to any other **Sample Edit > Main** page, and play the keyboard to listen to the sampled sound.

4 If you are not satisfied with the recorded sound, return to the **Sample Edit > Record** page, and touch the **Record** (●) button again, to repeat recording. Touch the **Record** (●) button again to stop recording.

5 When finished sampling your sound, save it to the internal User Sample memory.

6 Repeat the above procedure for all the samples you need.

Recording more samples for a Sound

To create an ordinary Sound, you need more samples to make a multisample. The best strategy is to record samples at a fixed distance, for example at each octave, diminished fifth, minor third, major second.

1 Repeat the recording procedure to create other samples.

2 Save the samples.

3 When finished, go to the **Sample Edit > Menu > Multisample** page to create a multisample.

Recording more samples for a Drum Kit

In a Drum Kit, each percussive sound is assigned to a different key. To create a Drum Kit, you have to record all the percussive samples making part of the Drum Kit (for example, the bass drum, the snare drum, the cymbals, the congas...).

- 1 Repeat the recording procedure to create other samples.
- 2 Save the samples.
- 3 When finished, exit **Sample Edit** mode.
- 4 Choose a Drum Kit to be used as a template for your new one, and access **Sound Edit** mode.
- 5 Go to the **Sound Edit > Menu > Drum Kit** page to create a new drum kit.

Editing an Audio Groove

If the new sample is an Audio Groove, go to the **Sample Edit > Menu > Time Slice** page to continue editing it.

Editing the samples

Editing the basic sample parameters

After recording, loading or importing, you can edit the samples.

- 1 Go to the **Sample Edit > Main > Edit** page.
- 2 Load, import or record the samples, as seen in the previous pages.
- 3 Touch the name of the sample to open the **Sample Select** window, and choose a sample.

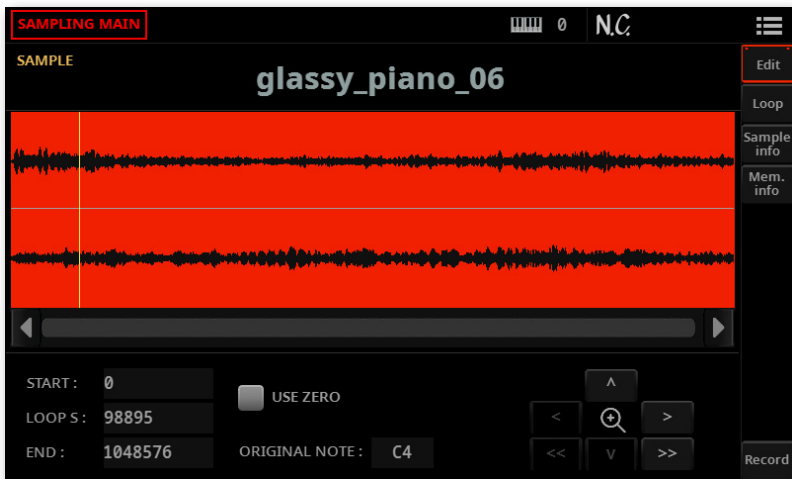

This page allows you to cut, trim or normalize a sample, as well as edit the loop points. The sample can be played over the full keyboard.

Reading the sample waveform diagram

The **diagram** shows the sample's waveform evolving during time (x-axis), and its changing amplitude (y-axis). It also shows the **Start**, **End** and **Loop** points. The area included between the **Start** and **End** points appears highlighted. The **Loop Start** point appears as a yellow vertical line.



Use the **Zoom** controls to change the size of the waveform shown in the diagram. When a button is greyed-out, it means the maximum or minimum value has been reached.

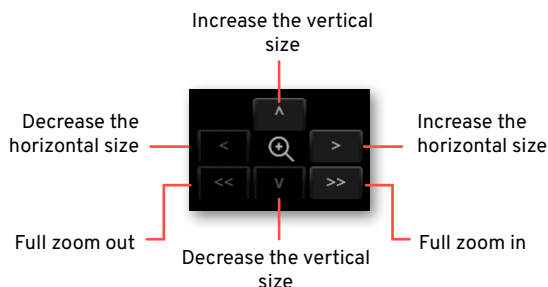

Changing the sample length

When recording, you may have included exceeding materials at the beginning and/or ending of the sample. You can cut them out of the sample.

> Use the **Start** parameter to edit the sample's start point (in samples). Match the start point with the actual attack of the sound you can see in the diagram.

If the Start point reaches the Loop Start point, this latter is also moved forward.

- > Use the **End** parameter to edit the sample and loop end point (in samples). Match this point to the actual end of the sound you can see in the diagram.

When saving the edited sample, the segments exceeding the Start and End points will be permanently removed.

Changing the loop start point

The loop is the cycling segment at the end of a sample, allowing for playing long notes while still using short recordings.

- > Be sure the **Loop On** checkbox is selected in the **Sample Edit > Main > Loop** page. Otherwise, moving the loop start point will have no effect.
- > When back to the **Sample Edit > Edit** page, use the **Loop Start** parameter to adjust the Loop Start point. When you adjust this parameter, an audible click may appear, due to a pitch and/or level mismatch between the starting and ending points of the loop. Move the Loop Start and Loop/Sample End point, so that the click can no longer be heard.

When editing audio grooves, the Loop Start should match the Sample Start point. This parameter usually differs from the Sample Start in ordinary sounds (that is, a guitar, a piano, a voice...).

Forcing the use of ‘zero-crossing’ points

When the **Use Zero** checkbox is selected, the Start, Loop Start and End points always fall on the nearest zero-crossing point (that is, a point where the waveform crosses the x-axis, and goes from negative to positive, or from positive to negative values). This will make loops more accurate, and will reduce the risk of clicks.

Choosing the original note

- > Use the **Original Note** parameter to choose the sample’s original pitch.

While this parameter has no immediate effect on the sound, it will be useful to identify the original pitch of the sample and when assigning a sample to the multisample.

For example, if you sample a C4, set this parameter to ‘C4’. When the sample will be assigned to a keyboard zone of the multisample, it will be transposed (if needed) according to this parameter, to avoid a change of the original pitch.

Normalizing the sample

Normalization automatically rescales the level of the selected sample. Peaks will be raised to 0dB (that is, maximum volume before clipping), while the remaining parts of the sample will be proportionally raised.

This helps optimizing the sample's level relative to other samples, making all samples sound more uniformly. It also helps optimizing signal/noise ratio, by preventing further stages of amplification from increasing any residual noise.

> While in any Sample editing page, choose the **Normalize** command from the **page menu** (☰).

Cutting away part of the sample

You can cut away the selected part of the sample.

- 1 While in the **Edit** page, use the **Start** and **End** points to choose the segment to cut away.
- 2 Choose the **Cut** command from the **page menu** (☰).

Cutting away the unused parts of the sample (trimming/cropping)

You can cut away the non-selected parts of the sample.

- 1 While in the **Edit** page, use the **Start** and **End** points to choose the segment to preserve.
- 2 Choose the **Trim/Crop** command from the **page menu** (☰).

Editing the sample loop

After editing the sample, you can fine-tune the loop.

- > Go to the **Sample Edit > Main > Loop** page.

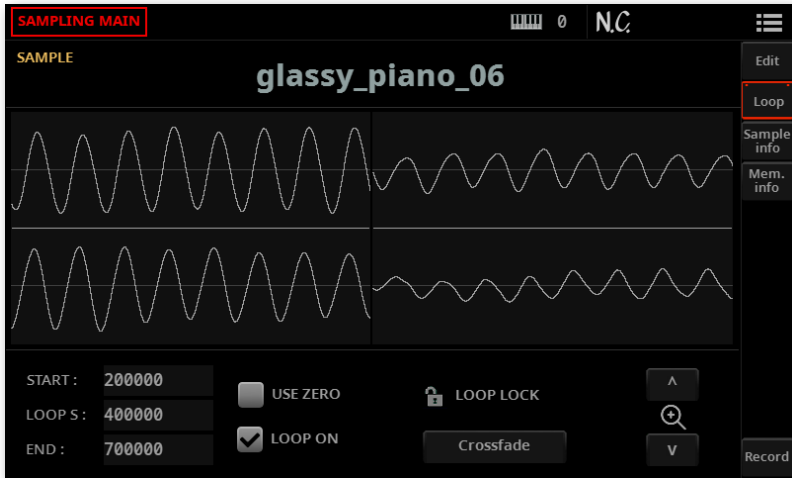

The loop is a cycling portion of a sampled sound. Looping is a technique used to reduce the sampling time, cycling a portion of the sound to create the sustaining phase of the sound. After the attack stage, most sounds repeat the same waveform during their sustain stage.

Reading the loop diagram

The diagram lets you fine tune the loop points, by watching at the Loop End (left half of the diagram) and Loop Start (right half of the diagram) points matching at the center of the diagram. A good-sounding loop is shown as a continuous, non-breaking line.

Use the **Zoom** controls to change the size of the looping ends shown in the diagram. When a button is greyed-out, it means the maximum or minimum value has been reached.



Changing the loop points

- > Be sure the **Loop On** checkbox is selected.
- > Use the **Loop Start** parameter to adjust the Loop Start point.
- > Use the **End** parameter to adjust the Loop End point (always matching the Sample End point).

Protecting the loop length

- > Use the **Loop Lock** to fix the length of the loop being edited. When it is closed, moving the Loop Start automatically moves the Loop/Sample End point, or vice versa.

This is convenient when you are creating a rhythmic loop to match a specific Tempo.

Using crossfade looping

When looping the pitched sample of a complex sound such as strings or woodwinds to make the sound sustain, it is necessary to create a long loop to preserve the rich character of the sound's body. Crossfade Loop can be used to minimize the difference in pitch and level between the beginning and ending of the loop region, to create a natural-sounding loop. In order to solve such problems, Crossfade Loop causes the sound to change gradually from the end to the beginning of the loop.

In practice, here is how it works. A specific length (the Crossfade Length value) of the waveform immediately before the beginning of the loop is taken and mixed with the end portion. At this time, the waveform level of the portion immediately before the end (the length specified by Crossfade Length) will gradually decrease, and the waveform level immediately before the beginning of the loop will gradually increase as the two are mixed.

When the **Loop On** checkbox is selected, and the **Start** and **Loop Start** parameters have different values, the **Crossfade** button becomes available.

- 1 Touch the **Crossfade** button to open the **Crossfade Loop** dialog:

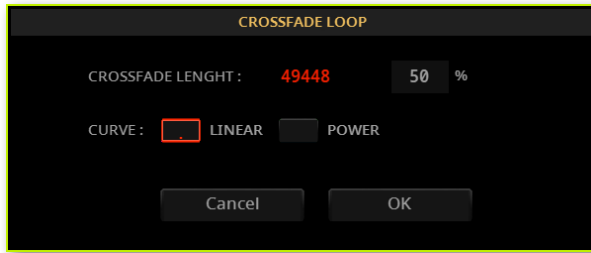

- 2 Use the **Crossfade Length** parameter to specify the length of the sample that you wish to crossfade. You can enter it either as the number of samples, or a percentage (%). If you set this as a percentage, the number of samples will be calculated automatically.

If you set this to 50%, crossfade will be performed on the second half of the region between loop start and loop end.

The Crossfade Length cannot be greater than the smaller length between the Sample Start – Loop Start points, or the Loop Start – Sample End points.

- 3 Use the **Curve** radio buttons to specify how the volume will change in the crossfading region.

Curve	Meaning
Linear	The volume will change linearly.
Power	The volume will change non-linearly. Sometimes a setting of Linear will produce the impression that the volume has dropped in the middle of the crossfade curve. In such cases, use Power.

Getting information on the sample in edit

You can get information on the sample being edited.

- > Go to the **Sample Edit > Main > Sample Info** page.



Sample Edit Info	Meaning
Selected Samples	Number of samples selected between the Start and End points.
Samples	Total size of samples in the sample file being edited.
Sampling Frequency	Sampling frequency of the sample being edited.

Getting information on the User Sample memory

In case you receive a message warning about not having enough User Sample memory, you can check what is filling it up. You will then be able to delete some data or compress the samples.

- > Go to the **Sample Edit > Main > Memory Info** page for information on the number and size of the samples, drum samples and multisamples in the User Sample memory.



Pa5X can use up to 4 GB of User Sample Memory without compression. This is the maximum amount of non-compressed samples that can be loaded or recorded. In case you need more User Sample memory, you can compress the samples and then load up to 8 GB of samples.

PCM Memory Usage	Meaning
Samples	Number of samples in memory.
Samples Size	Total size of the samples in memory.
Preload Buffer Size	Size of the memory buffer reserved to preloading samples from the virtual memory (residing on the internal drive) to the RAM memory.
Drum Samples	Number of drum samples in memory.
Multisamples	Number of multisamples in memory.

Saving, exporting or deleting the samples

Saving the sample

If you are creating a sample to be used in an ordinary Sound or Drum Kit, save the sample to the internal User Sample memory.

1 While in any page of the **Sample Edit > Main** section, choose the **Save** command from the **page menu** (☰) to open the **Save Sample** dialog.

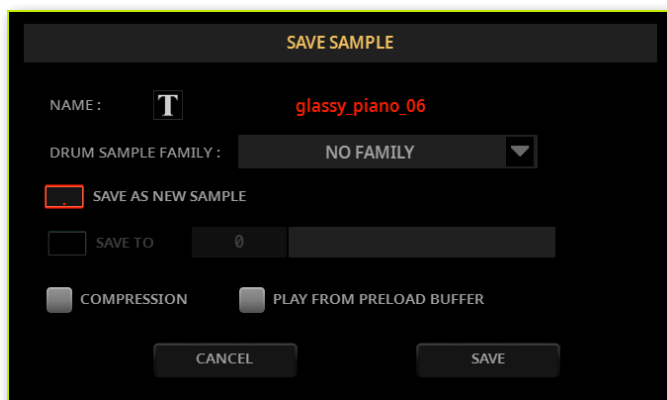

2 You may change the **name** of the sample. Touch the **Text Edit** (T) button to open the **virtual keyboard** and edit the name. When done editing the name, confirm by touching the **OK** button under the virtual keyboard.

3 If you are saving a percussive sample, use the **Drum Sample family** pop-up menu to assign it to a Drum Sample family.

4 Select an option to choose a location where to save the sample:

> Choose **Save as a new Sample** to save to a new location.

> Select **Save to** to overwrite an existing sample. In this case, the existing sample will be deleted.

5 If you want to compress the sample, select the **Compression** checkbox.

Pa5X comes with 4 GB of User Sample memory. This is the maximum amount of non-compressed samples that can be loaded or recorded. In case you need more User Sample memory, you can compress the samples and then load up to 8 GB of samples.

6 Confirm the Save operation by touching the **Save** button.

Compression, short loops, low volume

Loops shorter than 16 samples, and samples with volume too low (often resulting from sample slicing) can't be compressed. If you can't write a sample, disable the **Compression** option in the **Save Sample** dialog, then retry writing.

Play from preload buffer

When the **Play from preload buffer** option in the **Save Sample** dialog is selected, the sample will be entirely loaded to the RAM memory the next time it is selected.

This option is normally not needed. You can however select it when you need the sample to play over the full pitch range, or if you plan to use the sample in reverse.

With some samples, you may not be able to transpose up enough, and higher-pitched notes may sound at the wrong pitch. Since samples entirely read from RAM can be transposed higher than samples read directly from drive, if there are issues with higher-pitched notes, you may want to try with this option checked.

Also, reversing User Samples is only allowed when the samples are fully loaded into the RAM memory.

Preload buffer and compression

Since compression can't be applied to samples loaded to RAM, when the **Compression** parameter is checked you can't select the **Play from preload buffer** parameter.

Compressed samples can be transposed more than non-compressed samples read directly from drive. They can be transposed less than non-compressed samples entirely read from RAM.

Type of sample	Transposition
Non-compressed direct-from-drive	Less
Compressed direct-from-drive	Average
Non-compressed from RAM	More

Exporting samples

You can export the sample in edit to one of two popular computer audio file formats (WAVE and AIFF).

1 While in any page of the **Sample Edit > Main** section, choose the **Export** command from the **page menu** () , to open the **Export Sample** window.

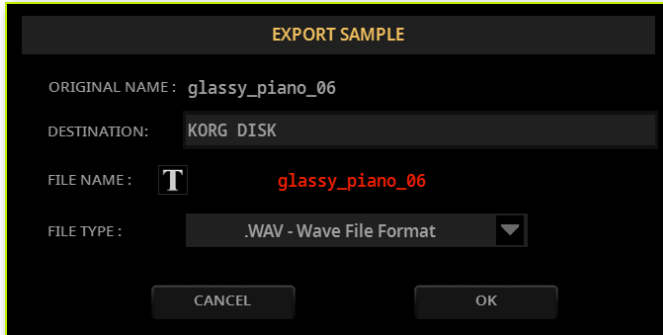

- 2 Touch the **Destination** parameter to choose a target location in the drives.
- 3 You may change the **name** of the sample. Touch the **Text Edit** () button to open the **virtual keyboard** and edit the name. When done editing the name, confirm by touching the **OK** button under the virtual keyboard.
- 4 Use the **File Type** pop-up menu to choose the file format in which to export the sample.
- 5 Confirm saving by touching the **OK** button.

Deleting samples

You can delete a sample, all the unused samples, or all the samples.

Accessing the Delete Sample dialog

> While in any page of **Sample Edit > Main** section, choose the **Delete** command from the **page menu** (☰) to open the **Delete Sample** dialog.

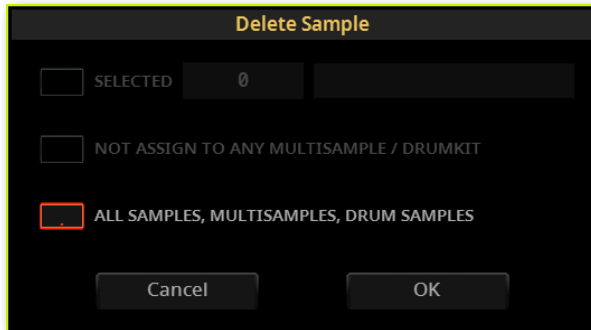

Deleting a sample

> Select the **Selected [n]** option, choose the **sample to be deleted**, and touch **OK** to confirm.

Deleting all the unassigned samples

> Select the **Not assigned to any Multisample/Drumkit** option, and touch **OK** to confirm.

This command deletes only samples not yet assigned to any Multisample or Drum Kit. Use this option with care, since you may delete samples you would like to preserve, but have not yet been assigned.

Deleting all the samples, multisamples and drum samples

- > Select the **All Samples, Multisamples, Drum Samples** option, and touch **OK** to confirm.

Select this command to delete all samples, multisamples and drum samples from the User Sample memory. This operation completely resets the User Sample memory, and may be used to clean-up any trouble with memory management.

Compressing the User Samples

Pa5X can read and play compressed User Samples. It can compress User Samples when saving them, or in batch. Sample compression allows for doubling the available User Sample memory.

Compressed samples can no longer be decompressed. If you want to keep the original samples, please save a copy before compressing them.

Compressing User Samples when saving them

You can compress a User Sample while writing it to the internal User Sample memory.

1 While in any page of the **Sample Edit > Main** section, choose the **Save** command from the **page menu** (☰) to open the **Save Sample** dialog.

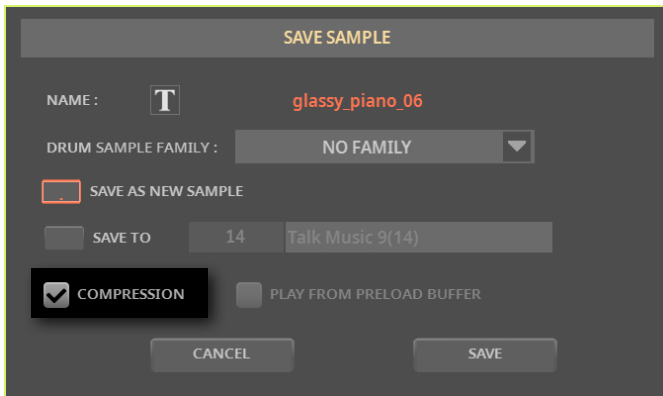

2 While in this dialog, select the **Compression** checkbox, to reduce the size of the sample up to a half of its original size. Please note that compression may require a long time.

Compressing all User Samples in memory

You can compress all the User Samples contained in the User Sample memory.

- 1 While in any page of the **Sample Edit** mode, choose the **Compress all samples** command from the **page menu** (☰) to run compression.

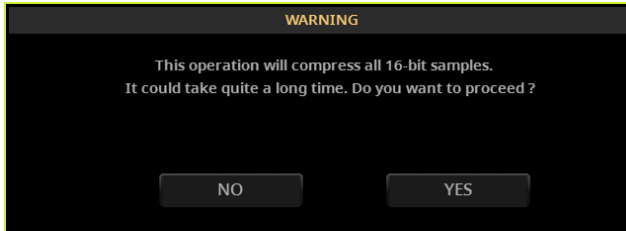

- 2 A message appears, warning about the long times needed to compress all the samples. Touch **Yes** to confirm.

Please do not turn the instrument off while compression is going on.

Multisamples

Creating multisamples

After having recorded, loaded or imported all the needed samples, you can create a multisample. The multisample is a way of organizing several samples on the keyboard. Each sample is assigned to a Keyboard Zone (or Index), with a higher and a lower limit. Later, the multisample will be assigned to an oscillator in an ordinary Sound.

Accessing the Multisample Edit page

- > Go to the **Sample Edit > Menu > Multisample > Edit** page.



In this page you will assign the sample(s) to a multisample. Each sample will be assigned to a different keyboard zone.

Choosing the multisample to edit

1 While in the **Sample Edit > Menu > Multisample > Edit** page, touch the name of the multisample in edit, and open the **Multisample Select** window.

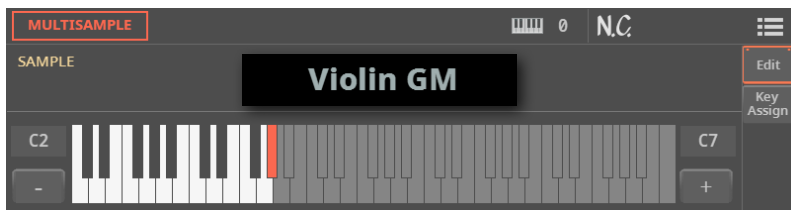

2 While in the **Sample Select** window, scroll through the samples, then touch the one you want to select and edit.

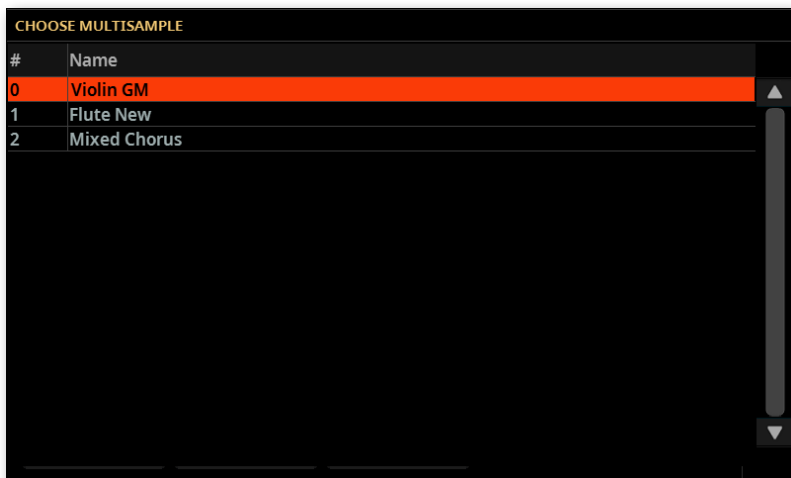

- 3 Touch the name of a multisample to select it.

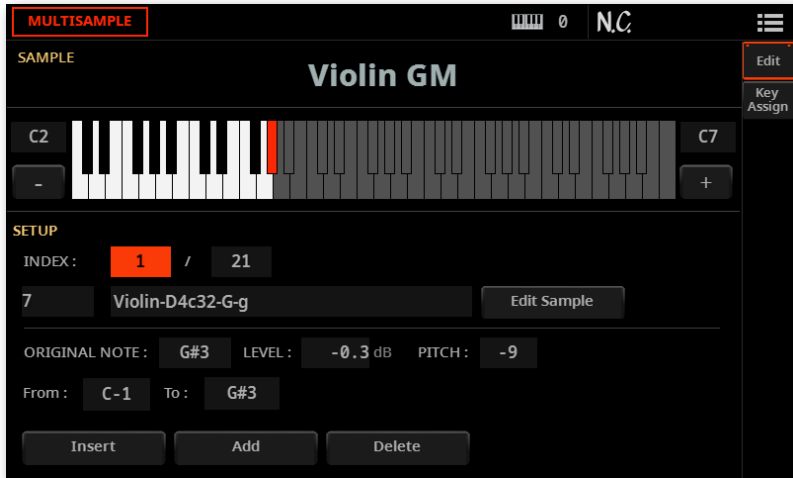

Reading the multisample diagram

The keyboard diagram shows the selected Keyboard Zone (highlighted), and its Original Note (in red). Use the big '-' and '+' buttons on its side to scroll the diagram one octave lower or upper.

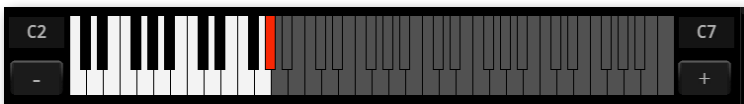

Assigning samples to the keyboard

■ Creating a new zone

By default, a new multisample contains a single zone.

- > Touch the **Insert** button to split the current zone in half, and create a new zone (Index) on the left of the selected one.
 - > Touch the **Add** button to add a new zone (Index) after the last one.
-

■ Deleting a zone

You can delete zones, when no longer needed.

- > Touch the **Delete** button to delete the selected zone (Index). The zone on the right of the deleted one is automatically extended to fill the gap.
-

■ Selecting a zone

- > Play a note on the keyboard to select the corresponding zone (Index).

As an alternative, use the **Index** parameter to choose the corresponding zone.

The total number of zones in the multisample is shown by the second number of the **Index** parameter.

■ Adjusting the zone range

- > Use the **From ... To** pair of parameters to adjust the range of the selected zone (Index).

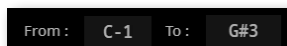

From : C-1 To : G#3

The minimum size is one key. When reducing the range of a zone, the adjacent one is automatically increased to fill the gap.

■ Assigning a sample to the selected zone

A zone always corresponds to a single sample.

- > Use the **Sample** parameter to choose a sample.

To create a silent zone, create it and assign no sample to it.

■ Setting the original note

> Use the **Original Note** parameter to automatically transpose the assigned sample on the keyboard. When you play this note, the sample will sound exactly as it was recorded.

By default, this parameter will match the **Original Note** value assigned when editing the sample in the **Sample Edit > Main > Edit** page.

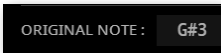

ORIGINAL NOTE : G#3

The note set with this parameter appears highlighted in the keyboard diagram.

■ Adjusting the level and pitch

> Use the **Level** parameter to adjust the relative level of the selected zone. This value can only be a negative offset to the overall volume of the multisample.

> Use the **Pitch** parameter to fine tune the selected sample in cents (1 cent = 1/100 of a semitone).



LEVEL : -0.3 dB PITCH : -9

■ Editing the selected sample

> Touch the **Edit Sample** button to go to the **Sample Edit > Main > Edit** page with the selected sample.

Overview of the assigned samples and zones

You can see the overall map of the samples assigned to the zones, and edit their range on the keyboard.

- > Go to the **Sample Edit > Menu > Multisample > Key Assign** page.

The screenshot shows the 'Key Assign' page for a 'Violin GM' multisample. At the top, there's a 'MULTISAMPLE' label and a 'Key Assign' button. Below is a piano keyboard with various samples assigned to different zones. The zones are listed on the left: A0, C-1, A3, C#4, E4, G#4, and A4. The right side shows the corresponding notes: C8, G#3, C4, D#4, G4, G#4, and A#4. Red arrows point to the 'Samples' list on the left and the 'Keyboard Zones' on the right.

- > Scroll through the zones by using the big **up/down arrows** under the **list of samples** on the left side of the page.



- > Edit the **zone range**, when needed, by using the low and high zone limits appearing on the left and the right of the keyboard zone diagrams. Please note you can't edit the lower note of the lowest sample (always set to C-1).

The close-up shows a keyboard zone diagram for 'Violin-D4c32-...'. The zone range is from A3 to C4. The A3 note is highlighted in red, indicating it is the original note of the sample.

- > The **Original Note** of each sample is shown in red.

Saving, exporting or deleting the multisamples

Saving the multisample

Before creating a Sound, save the multisample to the internal User Sample memory.

1 While in any page of **Sample Edit > Multisample** section, choose the **Save** command from the **page menu** (☰) to open the **Save Multisample** dialog.

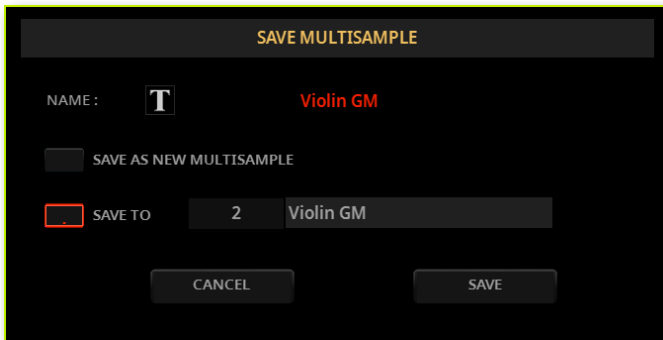

2 You may change the **name** of the multisample. Touch the **Text Edit (T)** button to open the **virtual keyboard** and edit the name. When done editing the name, confirm by touching the **OK** button under the virtual keyboard.

3 Select an option to choose a location where to save the multisample:

- > Choose **Save as a new Multisample** to save to a new location.
- > Select **Save to** to overwrite an existing location. In this case, the existing multisample will be deleted.

4 Confirm the Save operation by touching the **Save** button.

Exporting multisamples

You can export the multisample in edit, together with all the linked samples. The Export operation generates a KMP file (KORG's proprietary file format for multisamples), and a folder containing a series of KSF files (KORG's proprietary file format for samples) inside the same directory.

When exporting a stereo multisample, assign a different name to the Left and Right channel files, to avoid overwriting them. A '-L' and '-R' suffix is usually added after the name of this kind of files.

1 While in any page of the **Sample Edit > Multisample** section, choose the **Export** command from the **page menu** (☰), to open the **Export Multisample** dialog.

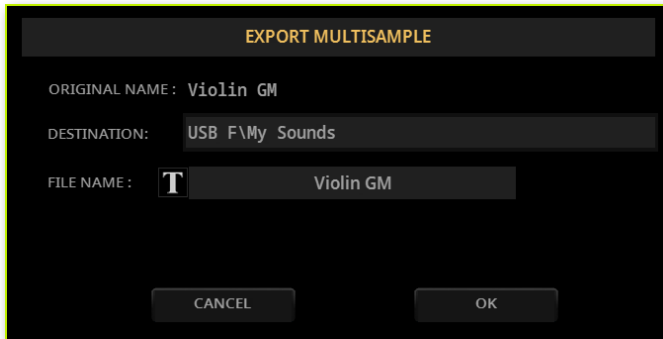

- 2** Touch the **Destination** parameter to choose a target location in the drives.
- 3** You may change the **name** of the multisample. Touch the **Text Edit (T)** button to open the **virtual keyboard** and edit the name. When done editing the name, confirm by touching the **OK** button under the virtual keyboard.
- 4** Confirm saving by touching the **OK** button.

Deleting multisamples

You can delete a multisample, the samples left unused after deleting the multisample, all the multisamples, or all the samples and multisamples.

Accessing the Delete Multisample dialog

> While in any page of **Sample Edit > Multisample** section, choose the **Delete** command from the **page menu** (☰) to open the **Delete Multisample** dialog.

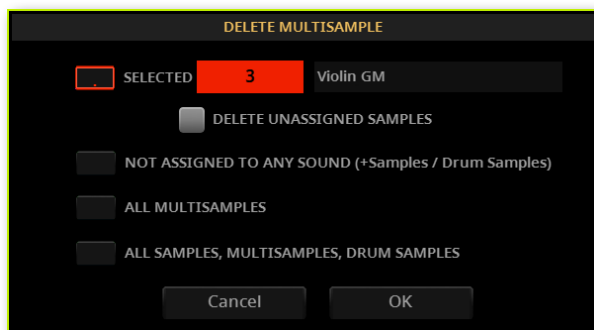

Deleting a multisample

> Select the **Selected [n]** option, choose the **multisample to be deleted**, and touch **OK** to confirm.

Deleting all the unassigned samples

> Select the **Delete Unassigned Samples** checkbox to also delete all the samples left free after deleting the multisample, and not used by other multisamples.

Use this option with care, since you may delete samples you would like to preserve, to be later used in new multisamples still to be created.

Deleting all multisamples not assigned to any Sound

- > Select the **Not assigned to any Sound (+Samples/Drum Samples)** option, and touch **OK** to confirm.

Select this command to delete from the User Sample memory all the multisamples, samples and drum samples that are not used by any Sound or Drum Kit. This will clean up the memory from all 'unlinked' multisamples, samples and drum samples that have remained in memory after deleting some Sounds or Drum Kits.

If you want to only delete all the 'unlinked' samples and drum samples, without deleting any multisample or drum kit, please use the **Delete** command that can be accessed from the **page menu (☰)** of the **Sample Edit > Main** pages. Be sure to choose the **Not assigned to any Multisample/DrumKit** option in the **Delete Sample** dialog.

Deleting all the multisamples

- > Select the **All Multisamples** option, and touch **OK** to confirm.

Deleting all the samples, multisamples and drum samples

- > Select the **All Samples, Multisamples, Drum Samples** option, and touch **OK** to confirm.

Select this command to delete all samples, multisamples and drum samples from the User Sample memory. This operation completely resets the User Sample memory, and may be used to clean-up any trouble with memory management.

Sounds and Drum Kits

Creating new Sounds from multisamples

You can create a new Sound while in **Sound Edit** mode.

- 1 Go to the **Sound Edit** mode.
- 2 Choose a **Sound** similar to the one you are going to create.

If you prefer to start from a blank, default situation, choose the **Initialize Sound** command from the **page menu** (☰).

- 3 Go to the **Sound Edit > Menu > Basic > Oscillator** page.

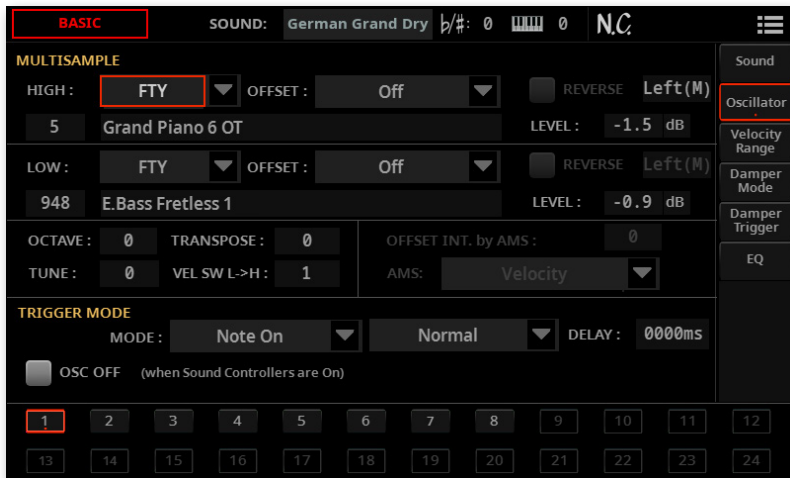

- 4 Select one of the available **oscillators** from the radio buttons at the bottom of the page.
- 5 Use the parameters in the **Multisample** section to assign the multisample to the **High** or **Low** layer of the selected oscillator. Your new multisample can be found in the **USR** bank of multisamples.
- 6 Go on editing the Sound, as shown in the pages dedicated to Sound editing.

Creating new Drum Kits from percussive samples

You can create a new Drum Kit while in **Sound** mode.

- 1 Go to the **Sound Edit** mode.
- 2 Choose a **Drum Kit** similar to the one you are going to create.

If you prefer to start from a blank, default situation, choose the **Initialize Sound** command from the **page menu** (☰).

- 3 Go to the **Sound Edit > Menu > DrumKit > DrumKit** page.

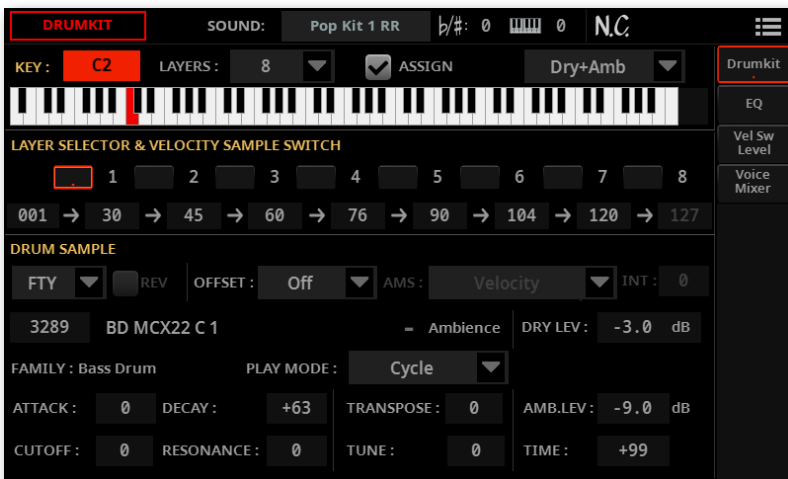

- 4 Use the **Key** parameter to select a key. As an alternative, select it by pressing a key on the keyboard.
- 5 Select one of the available **velocity layers** from the radio buttons under the keyboard diagram.
- 6 Use the parameters in the **Drum Sample** section to assign a sample to the current layer or the selected oscillator. Your new sample can be found in the **USR** bank of samples.
- 7 Go on editing the Drum Kit, as shown in the pages dedicated to Sound editing.

Assigning the new Sound or Drum Kit to a track

The new Sounds or Drum Kits are contained in the User folders. Assign them to the Keyboard, Pad, Style or Song tracks, as you would do with any other Sound or Drum Kit. Drum Kits are better suited for the Drum or Percussion track.

When done, save the Sound set (Keyboard Set, SongBook Entry, Pad, Style, MIDI Song) to preserve your editing.

Audio Grooves

Creating Audio Groove Slices with Time Slicing

Creating separate samples from a sliced audio groove

After recording or loading an audio groove, you must ‘slice’ it to create a series of separate percussive samples, a multisample to organize them on the keyboard, and a MIDI Groove containing the original sequence converted to MIDI events. In the end, you will save it as a new Sound.

How it works

Time Slicing detects the attacks (that is, for example, kick and snare shots) inside a rhythmic audio groove, and automatically divides the audio groove into individual percussive samples. The sliced percussive samples will be automatically assigned to different keys in a multisample, and the multisample to a Sound.

Within the generated multisample, a separate sample is assigned to a different note on the keyboard, starting from C#3. By playing an ascending chromatic scale with this multisample, you could recreate the original audio groove.

A MIDI Groove will also be created, containing a sequence of notes triggering the sliced percussive samples in the same order as in the original audio groove. When you will import this MIDI Groove to a Style or Pad track, this sequence will let you adjust the groove’s Tempo without affecting the pitch of the percussive samples.

In addition to changing the groove’s Tempo without affecting its pitch, this will let you change the order in which the samples are played, change the timing, and edit the pattern to freely recreate a new rhythm loop.

Slicing

- 1 Go to the **Sample Edit > Menu > Time Slice** page.



- 2 Use the **Meter** parameter to specify the Meter of the original sample.
- 3 Use the **Measures** parameter to specify the length of the original sample in measures. Preferably, you will load a groove 1- or 2-measures long.
- 4 The **BPM** (Beats Per Minute) parameter specifies the Tempo (in Beats Per Minute) of the original sample. This value is automatically calculated, based on the **Start** and **End** parameters (from the **Sample Edit > Main** page), and on the **Meter** and **Measures** parameters (from this page).

If you know these data, manually enter the **Meter**, **Measures** and **BPM** parameters, to make the slicing more accurate. The **BPM** value can be only adjusted to values lower than the one automatically calculated. This can be useful, for example, when the actual sample is shorter than the entered **Meter** and **Measures** values.

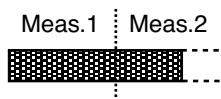

In the example above, the actual groove lasts only up to the first half of Measure 2. The recognized Tempo may be 130, but you know that the real Tempo is 100. Set the **BPM** value to 100, and a rest will be added to the end of the groove, to allow it to loop seamlessly.

- 5 Touch the **Slice** button to slice the original audio groove.

The generated samples and multisample

Each individual sample generated from slicing the audio groove will be assigned to a different key.

Key	Assigned sample/pattern	Speed %
C2	Full pattern cycling at half the speed	50%
C#2	Full pattern cycling at various speeds	53%
D2		56%
D#2		60%
E2		63%
F2		67%
F#2		71%
G2		75%
G#2		80%
A2		84%
A#2		89%
B2	94%	
C3	Full pattern cycling at the original speed	100%
C#3 and above	Separate sliced samples	-

The generated MIDI Groove

After slicing, a MIDI Groove with the original pattern will also be generated. The diagram will show the individual sliced samples separated by vertical lines:

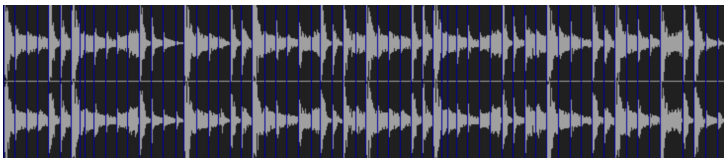

Testing the generated multisample

- > To test the full pattern at different speed, play a note from C2 (half speed) to C3 (original speed). See table above.
- > To test the single sliced samples, play notes from C#3 and above. If you play a full chromatic scale, you can play the original pattern.

If too many samples have been generated, and the keyboard can't fit them all, use the **UPPER OCTAVE** buttons to transpose the keyboard, and also listen to the samples exceeding the upper limit.

Adjusting the slicing parameters

- > If the Slice procedure didn't produce satisfactory results, adjust the **Release** parameter, and touch the **Slice** button again.

Adjusting the **Release** value changes the number of recognized attacks, by varying the speed needed to the Slice engine to start working again on the next one. For example, in the following example, if the Release value is too high (that is, too long), the second attack may be lost:

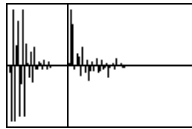

- > If this, again, does not produces good results, try to also adjust the **Threshold** parameter, and touch the **Slice** button again.
- > Since a Tempo value rounding happens during the Slice operation, and the loop may not be accurate, you may need to adjust both the **Start** and **End** parameters of the **Sample Edit > Main** page, to make the groove loop flawlessly. After editing these parameters, touch the **Slice** button again.

Go on experimenting different settings. Editing an audio groove is a pure matter of experimentation.

Extending the sample tails

When using the sliced grooves with a Tempo slower than the original, an annoying gap may be heard between a sample and the following one. The Extend function allows you to fix this problem by adding a ‘tail’ to all samples, making their decay smoother and more musical.

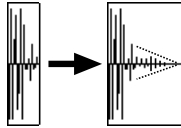

- 1 After slicing and testing the groove, use the Extend function if needed.
- 2 Go to the **Sample Edit > Menu > Time Slice** page.



- 3 Adjust the **Extend > By** parameter to set the length of the ‘tail’ added to the samples (in percentage). A setting of 20-30% is usually suitable to most grooves.

Depending on the Tempo of the Style that will include this groove, use high or low values. If you will slow down the groove very much, assign higher values to this parameter, otherwise you may assign lower values.

Be careful with the higher **By** values, because the Extend function may add audible artifacts.

4 Use the **Extend Mode** pop-up menu to specify if the added ‘tail’ must decay in a linear way, or sustain for a longer time and then fall suddenly. Choose the Extend method suitable for the processed materials.

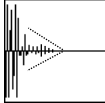
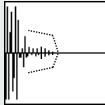
Extend Mode	Meaning	Shape
Normal	Most suitable for percussive sound with a short (but not immediate) decay. The ‘tail’ envelope is linear, and the level decays fast.	
Long	Most suitable for cymbals, whose sound should be sustained up until the next note. The ‘tail’ envelope is sustained and falls slowly, then falls suddenly next to the end.	

5 Touch the **Extend** button.

6 After the Extend operation has been completed, test the pattern.

> To test the full pattern at different speed, play a note from C2 (half speed) to C3 (original speed). See table above.

> To test the single sliced samples, play notes from C#3 and above. If you play a full chromatic scale, you can play the original pattern.

7 If the Extend operation didn’t produce satisfactory results, change the settings and repeat it.

Saving the Audio Groove Slices

Once the Time Slicing procedure is completed, you can save the data as a new Sound, together with a series of separate percussive samples, a multisample arranging them on the keyboard. A MIDI Groove containing the original sequence converted to MIDI events will also be created.

1 While in the **Sample Edit > Time Slice** page, choose the **Save** command from the **page menu** (☰).

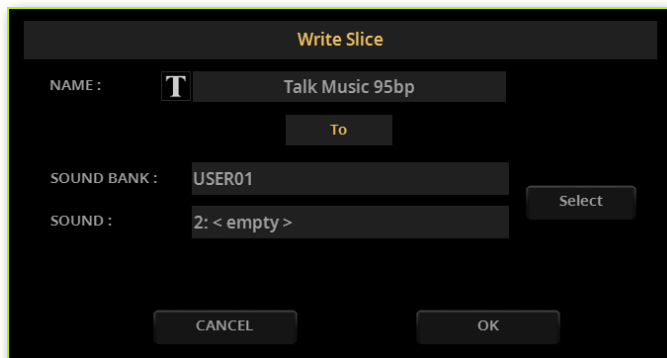

2 You may change the **name** of the Sound. Touch the **Text Edit (T)** button to open the **virtual keyboard** and edit the name. When done editing the name, confirm by touching the **OK** button under the virtual keyboard.

3 When back at the **Save Sound** dialog, if you want to save onto a different location touch the **Select** button and open the **Sound Select** window. The Sounds are organized in a rigid grid. Choose a location as if you were choosing a Sound. Blank locations are shown as a series of dashes ('---').

4 When back at the **Save Slice** dialog, confirm the Save operation by touching the **OK** button.

Together with the Sound and the associated samples and multisample, a MIDI Groove with the same name will also be saved to the RAM memory. This memory will be deleted when turning the instrument off. Therefore, immediately convert the MIDI Groove to a Style or Pad pattern, as explained in the following pages.

Using the Audio Groove Slices in a Style or Pad

After generating the Audio Groove Slices, you can use them in a Style or Pad, by importing the MIDI Groove to a track, and assigning the corresponding Sound to the same track.

Imported grooves can play at different Tempo values. However, please remember that they will not be transposed when playing different chords, since they are still audio data, that cannot be transposed by the Arranger.

Importing the MIDI Groove to a Style or Pad track

- 1 Exit from the **Sample Edit** mode.
- 2 Access **Style/Pad Edit** mode, either creating a new Style/Pad or editing an existing one.
- 3 Go to the **Style/Pad Edit > Menu > Import/Export > Groove** page.

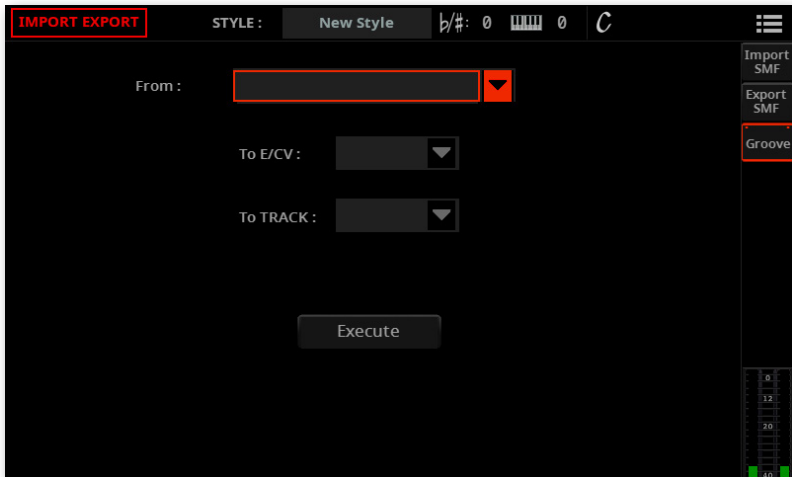

4 Use the **From** pop-up menu to choose the MIDI Groove. (This menu only appears if a MIDI Groove has been generated when saving a Slice from the **Sample Edit > Time Slice** page).

5 Use the **To E/CV** pop-up menu to choose a target Style Element and Chord Variation.

- 6 Use the **To Track** pop-up menu to choose a target track. We suggest the Percussion track, since the Drum track is better left free for standard Drum Kit sounds (for count-ins, breaks, etc.).
- 7 Touch the **Execute** button to confirm.

Assigning the Sound to the Style or Pad track

After having imported the MIDI Groove, assign the Sound generated by the Time Slicing procedure to the track playing the MIDI Groove.

■ Assigning the Sound to a Style

- 1 Exit from the **Style/Pad Edit** mode.
- 2 Go to the **Home > Menu > Mixer/FX > Main** page (or any other page showing the name of the Style Sounds).



- 3 If the Style Sounds are not shown, touch the **TRACK SELECT** button to see them.
- 4 Touch the **name of the Sound** in the track to which to assign the Sound (we suggest the Percussion track), and open the **Sound Select** window.
- 5 Choose the Sound containing the MIDI Groove.
- 6 Save the Style.

■ Assigning the Sound to a Style Element track

1 While still in the **Style Edit** mode, go to the **Style Edit > Menu > Mixer/FX > Main** page (or any other page showing the name of the Style Sounds).

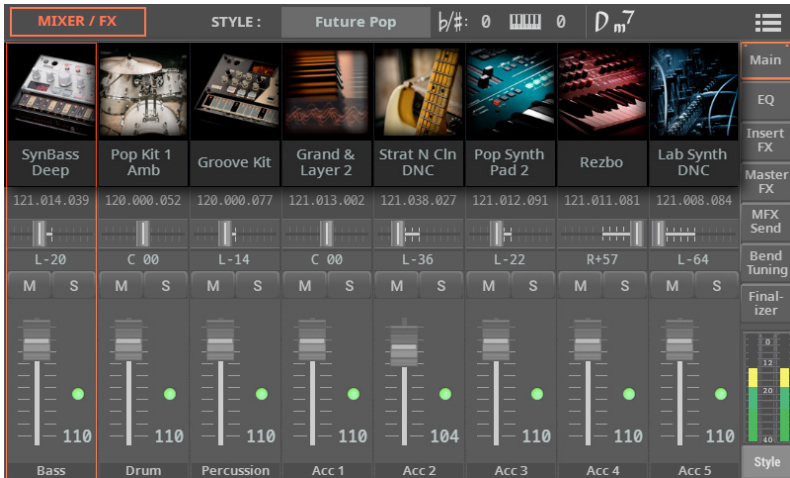

2 Press the corresponding button on the control panel to select one of the **Style Elements (INTRO 1 ... ENDING 3)**.

3 Touch the **name of the Sound** in the track to which to assign the Sound (we suggest the Percussion track), and open the **Sound Select** window.

4 Choose the Sound containing the MIDI Groove.

5 Save the Style.

■ Assigning the Sound to a Pad

1 While still in the **Pad Edit** mode, go to the **Pad Edit > Main** page (or any other page showing the name of the Pad Sound).

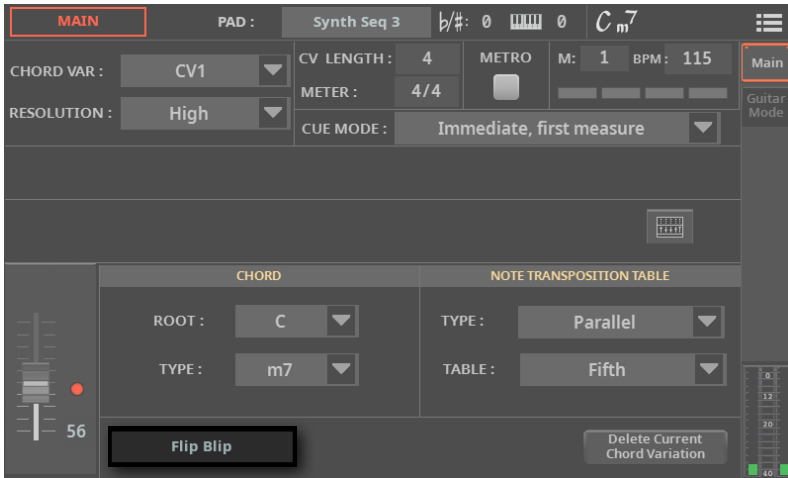

2 Touch the **name of the Sound**, and open the **Sound Select** window.

3 Choose the Sound containing the MIDI Groove.

4 Save the Pad.

Using the Audio Groove Slices in other Sounds

You can use the multisample and samples generated by a Time Slicing operation in other Sounds.

1 Go to the **Sound Edit** mode, and choose a Sound similar to the one you want to assign the multisample to.

If you prefer to start from blank programming, choose the **Initialize Sound** command from the **page menu** (☰).

2 Go to the **Sound Edit > Menu > Basic > Oscillator** page, and select one of the oscillators.

3 Choose the new **multisample** from the **USR** area, and assign it to one of the two layers (**High** or **Low**).

4 Choose the **Save Sound** command from the **page menu** (☰), and save the Sound to an empty User location.

33

Effects for the Microphone

Editing the Mic Presets

Accessing Mic Preset page

You can edit and save the User Mic Presets. Factory Mic Presets are protected. If you access editing with a Factory Mic Preset, a temporary copy is automatically created in memory.

- 1 While in the **Home** mode, press the **MENU** button to see the **Home Edit** menu.

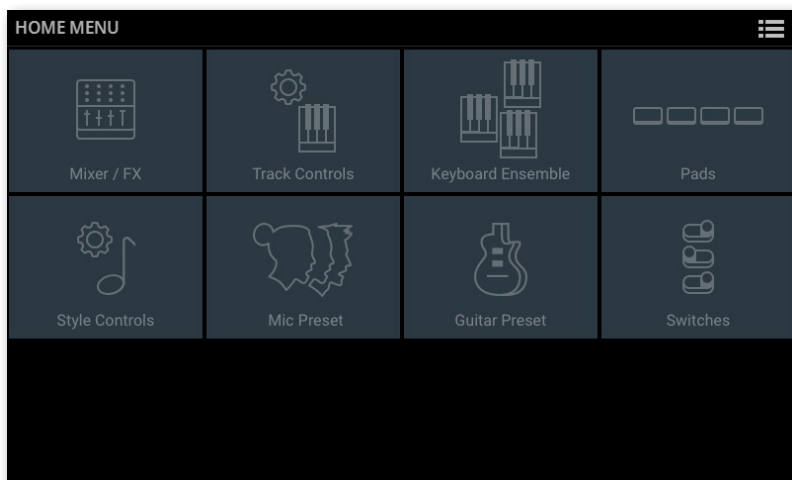

- 2 Touch the **Mic Preset** button in the menu. The **Mic Preset** page will appear.

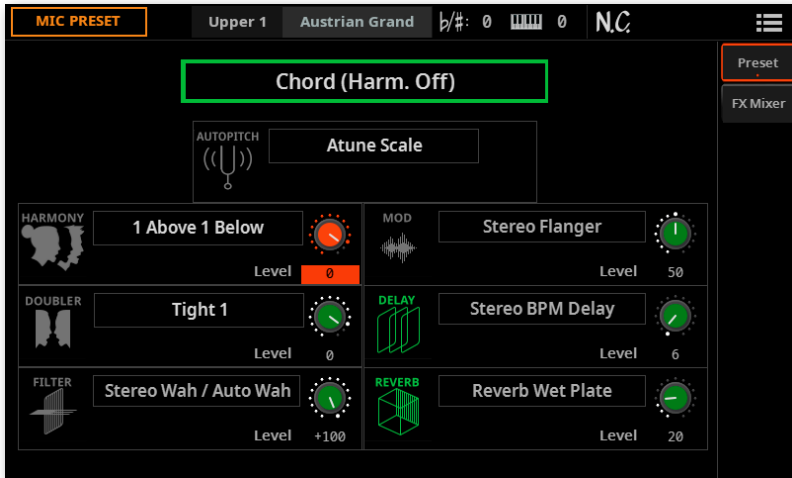

- 3 Press the **EXIT** button if you want to return to the **main Home** page.

Choosing, enabling and balancing the effects

While in the **Mic Preset** page, you can choose a Mic Preset, turn on/off the various effect blocks, choose the effects for each block, and adjust the level of each block.

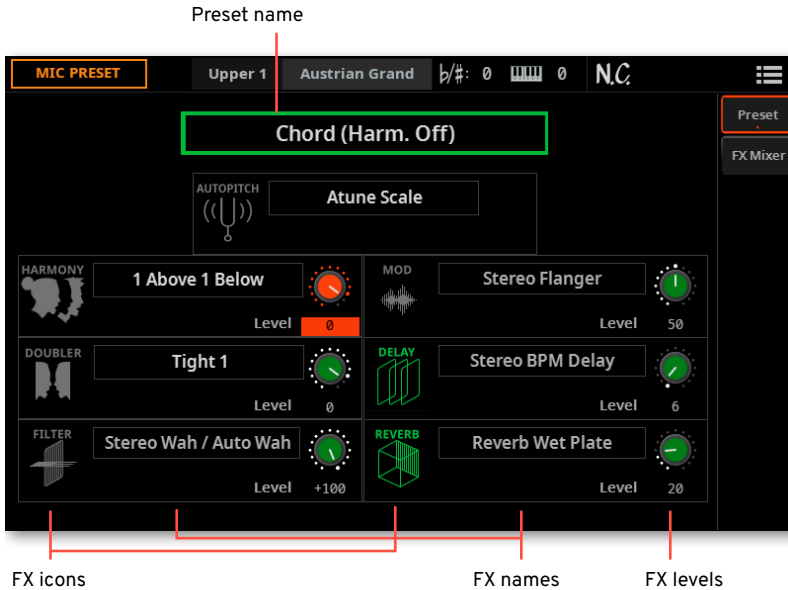

- > Touch the **name of the Preset** to choose a different Mic Preset.
- > Touch the **icon of an effect** to turn the corresponding block on/off. An equivalent **On/Off** button is also found in all the effect editing pages.
- > Touch the **name of an effect** to open the **FX Edit** window for that block. Press the **EXIT** button to return to this page.
- > Adjust the **Level** of each block to balance the effects.

The Auto Pitch

Depending on the settings, the **Auto Pitch** function can work as a subtle and transparent pitch correction, or as a massive Cher-like effect.



- 1 While in the **Mic Preset** page, touch the **name of the Auto Pitch effect** to open the **Auto Pitch** dialog.

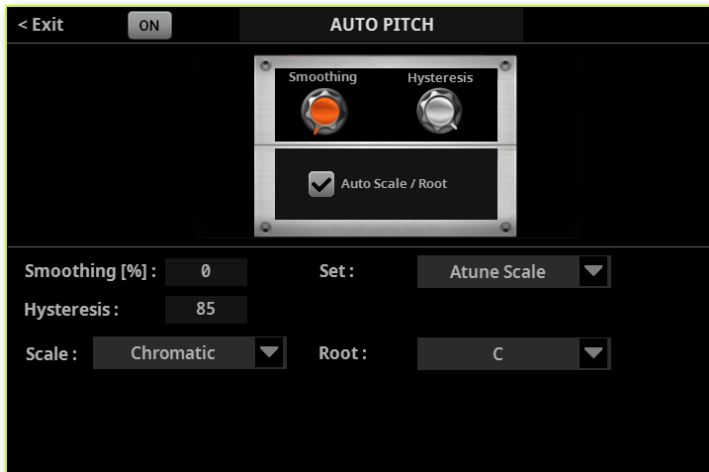

- 2 Edit the parameters, as described below.
- 3 When done, return to the **Mic Preset** page by pressing the **EXIT** button.
 - > Use the **Smoothing** control to make note transitions slower or faster. Too fast a transition, and the change may sound ‘jumpy’. Too slow, and excessive glissando or ‘smoothing’ may appear. Higher values make the transition slower, and the smoothing effect higher.
 - > Use the **Hysteresis** control to set how far from the target note the source note can go, before the target note will change. Higher values maintain the note even in case of heavy oscillations in the source note.

- > Use the **Set** pop-up menu to choose the **Auto Pitch Preset**.

Auto Pitch Preset	Meaning
Atune Scale	Auto Tune scale
Natural Scale	The target notes is part of the selected scale
Natural Chromatic	The target notes is part of the chromatic scale, with preference for the natural scale
Robot	A more artificial-sounding correction

- > Use the **Scale** and **Root** parameters to choose a reference scale to which to adapt the target notes.

Editing the Harmony voices

You can edit the Harmony voices.

- 1 While in the **Mic Preset** page, touch the **name of the Harmony effect** to open the **Harmony** window.

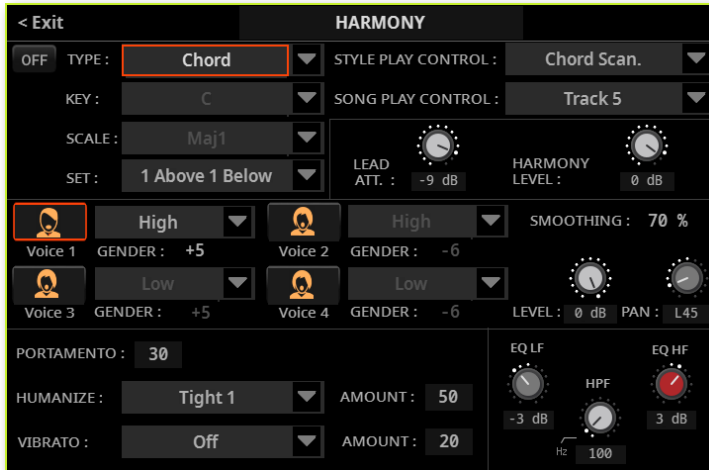

- 2 Edit the parameters, as described below.
- 3 When done, return to the **Mic Preset** page by pressing the **EXIT** button.

Setting the general harmony parameters

The top area of the page contains general parameters for choosing the type of harmonization and the control source.



■ Choosing the harmony type

> Use the **Type** pop-up menu to choose the type of harmonization.

Harmony Type	Meaning
Chord	Chords are to be played on the keyboard, by the Chord Sequencer, received from a MIDI Song or via MIDI. When this type is selected, you can choose the source of the controlling chords (as explained below).
Scale	Harmony notes are adapted to the selected scale. When this type is selected, you can choose the Key/Scale (as explained below).
Shift	Harmony notes are exactly the indicated interval above or under the Lead voice.
Notes	Harmony voices play the notes played on the keyboard, received from a MIDI Song or via MIDI. When this type is selected, you can choose the source of the controlling notes (as explained below).

■ Choosing the source of chords or notes

> Use the **Style Play Control** pop-up menu to choose a source for chords or notes controlling harmony with the Styles.

Control (Style)	Meaning
Chord Scan	Play chords or notes in the area chosen with the CHORD buttons in the control panel.
Lower	Play chords or notes in the Lower area (under the split point).
Upper	Play chords or notes in the Upper area (above the split point).
Full	Play chords or notes over the full extension of the keyboard.

- > Use the **Song Play Control** pop-up menu to choose a source for chords or notes controlling harmony with the Songs.

Control (Song)	Meaning
Off	No track sends chords notes to the Harmony module. Chords can still be received via MIDI.
Track 01...16	Chords or notes are received from one of the Song tracks.
Chord Scan	Play chords or notes in the area chosen with the CHORD buttons in the control panel.
Lower	Play chords or notes in the Lower area (under the split point).
Upper	Play chords or notes in the Upper area (above the split point).
Full	Play chords or notes over the full extension of the keyboard.

■ Choosing the Key and Scale

When the **Scale** Harmony Type is selected, all of the chords in an entire song and your melody can belong to a single key. You can input this key by using the **Key** parameter.

Use the **Scale** parameter to choose a type of scale for the harmony notes. You can choose between 3 Major and 3 Minor alternate scales that can be chosen if your harmony intervals sound incorrect at certain chord/melody combinations.

When the match of Key and song is correct, a Scale harmonization is nearly indistinguishable from recorded harmony. There are limitations however:

- > Scale works for many, but not all songs.
- > Scale works best with 3rd harmony intervals (**Voice > Harmony Scale** pop-up menu); adding the 5th reduces the number of compatible songs.

You should be singing with musical backing and stay true to a A=440Hz reference. This could be a recorded song or other musicians. Choose a simple song to start with. Determine the key of your song; this is often the first or last chord in a song without extensions. For example G Major is a valid key, Gm7b5 is not.

If you're lucky the first time, you'll be rewarded with soaring harmony over your whole chorus or song. If not, you can try the following:

- > Try a different Key, perhaps a 5th away from your first choice.
- > Choose a different Major or Minor alternate Scale.
- > Choose a Set with only the 3rd (High) interval.

■ **Choosing a Harmony set**

> Use the **Set** pop-up menu to choose a set of voices for the Harmony block. The name of the chosen set will give an idea of what the voices will do.

■ **Adjusting the Lead level**

> Use the **Lead Att(enuation)** control to lower the level of the lead voice in the mix.

■ **Adjusting the Harmony level**

> Use the **Harmony Level** control to adjust the level of the Harmony voices.

Programming the individual harmony voices

The center area of the page contains parameters to program the individual voices. It is different, depending on the selected Harmony Type.

Harmony Type	Individual Voice Box
Chord	
Scale	
Shift	
Notes	

- > Touch the **Voice 1-4** buttons to choose the harmony voice to program.

■ Chord type: Choosing the Harmony Voicing

Harmonies will be generated depending on the recognized chord and the chosen voicing.

- > For each voice, use the **Harmony Voicing** pop-up menu to specify the relation of the harmony note to the input note with respect to the current chord.

In Chord mode presets, the harmony voices are always notes in the chord. A setting of High will result in the harmony voice being the next note above the input voice in the chord. For instance, if the chord was C Major and the input note was an E, an High setting would produce a G harmony voice, just above the input E.

■ Scale type: Choosing the Harmony Scale

Harmony intervals will be adapted to the selected scale.

- > For each voice, use the **Harmony Scale** pop-up menu to specify the interval of the harmony note with respect to the input note in the scale.

The range of values goes from -2VE, which is 2 octaves below the input note, to +2VE which is two octaves above the input note. For example, a setting of +3 will result in a harmony voice a third above the input voice.

■ Shift type: Choosing the Harmony Shift

Harmonies will be a fixed interval in reference to the input note.

- > Use the **Harmony Shift** pop-up menu to choose the interval the harmony voice is shifted relative to the input note. The values range from -24 semitones to +24 semitones.

■ Notes type: Programming the envelope

Harmonies will be the ones played by the source (keyboard, Style, Song).

- > Use the **Octave Transpose** parameter to transpose the harmony notes.
- > Use the **Attack** parameter to add a gentle volume fade-in when you strike a note during a sustained sung note. The values range from 0 to 1000 milliseconds.
- > Use the **Release** parameter to add a smooth fade-out if you release your note as you continue to sing. The values range from 0 to 2000 ms.
- > Use the **Smoothing** parameter to make the voice attack smoother and better in tune.

At low values, Smoothing acts like pitch correction for the harmony voices. With the voices corrected like this, some Portamento is usually required to help soften note to note transitions unless a robot-like effect is desired. Higher values offer progressively less correction. Like Portamento, setting each voice with a unique value of the Smoothing parameter helps the harmonies sound more natural. Please note that high values of smoothing will sound out of tune.

■ Choosing the individual voice's gender

- > Use the **Gender** parameter to make timbre adjustment to the voice. Values below 0 lend each voice a more masculine and deeper effect, and values above 0 lend a more feminine or thinner effect.

■ Adjusting the Level and Pan of the individual voices

- > Use the **Level** parameter to control the relative volume of each voice. This is also where voices are turned on or off. The range of values goes from Off to 0 dB (Full). Typically all voices are set at the same level unless you want to highlight or minimize a particular voicing interval.
- > Use the **Pan** parameter to set a unique pan position for each voice. There are 64 possible steps in each of the left and right pan positions.

When the Notes Harmony Type is selected, you can select between Narrow, Medium and Wide panning.

Portamento, humanize and vibrato

For the preset as a whole, you can add expression, by programming portamento, humanize and vibrato.

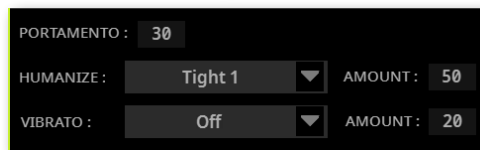

■ Setting portamento time

- > Use the **Portamento** parameter to set the portamento time.

Portamento is a delayed response to the pitch movement of your singing voice. It is also referred to as 'Glide' in synthesizers. The range of values equals approximately how long the upwards or downwards slide will take to reach each new note.

■ Humanizing the harmony voices

- > Use the **Humanize** pop-up menu to choose a humanization style.

The term 'humanize' simply means the application of processes designed to increase realism. All harmony modes usually benefit from careful application of humanization styles that make each harmony voice respond with small pitch and timing variations different from your voice. Each Humanize Style configures each of the four voices differently; Voice 1 has slightly different parameter values than say Voice 4 in the same style but all four voices will work together to produce a useful overall effect.

The various Humanization styles consist of various amounts of the following modifiers:

Onset pitch events – This is also known as ‘scooping’ which adds a generated pitch trajectory for each new note that is different than the sung note.

Pitch modulation – A random wave generator wobbles the pitch in non-periodic ways to simulate even the finest singers’ pitch variation.

Timing delay and modulation – Singers are unable to start notes at the same time with the exactness of a machine so this algorithm applies slight delays to the onset of notes and then adds modulated time variation to sustained portions of notes.

Level (volume) modulation – This effect is like a subtle tremolo with a non-periodic or semi random waveform that simulates the way different singers change note volumes as they sing.

> Use the **Amount** parameter to vary the amount of humanization for the harmony voices. Most of the styles were designed at middle values to allow you to add or remove effects as you see fit.

■ Adding vibrato

> Use the **Vibrato** pop-up menu to choose a vibrato style.

Vibrato assists in providing separation between your dry singing voice and the harmonies as well as to add some movement to the rigid pitch contour in Notes mode harmony. Even the smallest amount of vibrato applied to your harmony voices can achieve this. Like the Humanize effects, each voice is treated slightly differently by the Vibrato algorithm so the voices don’t all sound exactly the same.

> Use the **Amount** parameter to vary the amount of vibrato intensity for the overall style with this parameter. All the styles were designed to be useful at middle values but you can add or remove vibrato as you like.

Programming the EQ

The bottom-right area of the page contains the final equalizer for the block.



- > Use the **EQ LF** and **EQ HF** controls to apply Low-Frequency and High-Frequency equalization to all the harmony voices.
- > Use the **HPF** control to adjust the High-Pass Filter, useful to remove rumble or boominess.

Editing the Doubler effect

- 1 While in the **Mic Preset** page, touch the name of the Doubler effect to open the **Doubler** window.

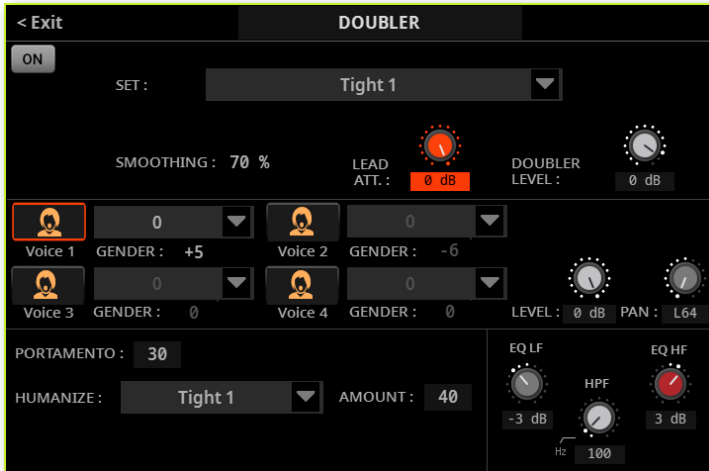

- 2 Edit the parameters, as described below.
- 3 When done, return to the **Mic Preset** page by pressing the **EXIT** button.

The Double effect uses the same type of Humanization technology as in the Harmony effect to create up to four overdubbed versions of your voice. The voices are set to unison intervals as opposed to the moveable intervals available for the harmony voices. Double simulates the sound of a vocalist overdubbing their vocal part multiple times. Many of the edit parameters for the Doubling page are the same as for Harmony page.

■ Choosing a Double set

- > Use the **Set** pop-up menu to choose settings for the Double block. The name of the chosen set will give an idea of what the voices will do.

■ Adjusting the Lead level

- > Use the **Lead Att(enuation)** control to lower the level of the lead voice in the mix.

■ Adjusting the Doubler level

- > Use the **Doubler Level** control to adjust the level of the doubling voices.

■ Adjusting the Level and Pan of the individual voices

- > Use the **Level** parameter to control the relative volume of each voice. This is also where voices are turned on or off. The range of values goes from Off to 0 dB (Full). Typically all voices are set at the same level unless you want to highlight or minimize a particular voicing interval.
- > Use the **Pan** parameter to set a unique pan position for each voice. There are 100 possible steps in each of the left and right pan positions.

■ Humanizing the Doubler voices

- > Use the **Humanize** pop-up menu to choose a humanization style.

The term 'humanize' simply means the application of processes designed to increase realism. Contrary to the same parameter of the Harmony page, humanization is the same for all the doubling voices.

- > Use the **Amount** parameter to vary the amount of humanization.

■ Programming the EQ

- > Use the final equalizer parameters for this block. The parameters are the same seen for the Harmony block.



Editing the Filter effect

- 1 While in the **Mic Preset** page, touch the name of the Filter effect to open the **Filter** window.



- 2 Edit the parameters, as described below.
- 3 When done, return to the **Mic Preset** page by pressing the **EXIT** button.

You can assign to this block effects from the Filter, Dynamics and Frequency categories. For details about the effects, see [Effects for the Sounds](#) on page 1007.

Filters can be used, for example, to emulate the sound of radios, phones and devices that generally degrade the audio signal.

Editing the Mod effect

- 1 While in the **Mic Preset** page, touch the name of the Modulation effect to open the **Modulation** window.



- 2 Edit the parameters, as described below.
- 3 When done, return to the **Mic Preset** page by pressing the **EXIT** button.

You can assign to this block effects from the Modulator and Mixed categories. For details about the effects, see [Effects for the Sounds](#) on page 1007.

You can use modulation for different effects, ranging from subtle but lush thickening to creatively destructive.

Editing the Delay effect

- 1 While in the **Mic Preset** page, touch the name of the Delay effect to open the **Delay** window.

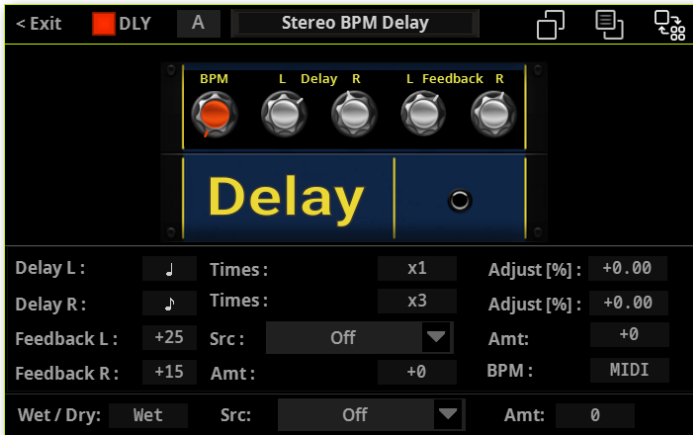

- 2 Edit the parameters, as described below.
- 3 When done, return to the **Mic Preset** page by pressing the **EXIT** button.

You can assign to this block effects from the Delay category. For details about the effects, see [Effects for the Sounds](#) on page 1007.

The delay effect is a configurable echo. You can control how far apart the echoes occur (Delay Time), and whether the echoes fade out quickly or slowly or build on themselves. In addition, there are filtering and stereo controls that allow you to create many popular delay sounds.

Editing the Reverb effect

- 1 While in the **Mic Preset** page, touch the name of the Reverb effect to open the **Reverb** window.



- 2 Edit the parameters, as described below.
- 3 When done, return to the **Mic Preset** page by pressing the **EXIT** button.

You can assign to this block effects from the Reverb category. For details about the effects, see [Effects for the Sounds](#) on page 1007.

Reverb is arguably the most common vocal effect. It can add a spaciousness that softens the abrupt beginnings and endings of lyric phrases. Many reverb types are meant to imitate the natural sound of spaces like churches, clubs and halls but not all. Some reverb effects are recreations of electro-mechanical effects meant to imitate real spaces like plates and springs.

Reverbs are made up of early reflections and the longer reverberant sounds known as the tails. There are usually controls to control the balance of room level and tail. Additionally, a small delay can be added between the dry voice and the reverb signal that adds clarity by briefly separating the dry voice from its reverb. By far the most important control for reverb is the level. A single reverb patch can have a different result for the audience whether it is mixed quietly or boldly in the mix.

Mixing the lead voice and the effects

While in the **Voice Preset > FX Mixer** page, you can set the master level of the effects, and internally route the effects.

- 1 Go to the **Home > Menu > Mic Preset > FX Mixer** page.

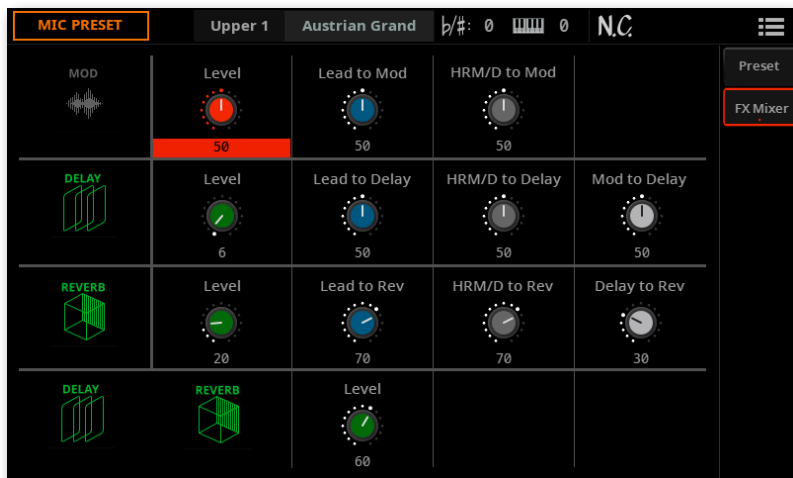

- 2 Adjust the levels.
 - > Turn the effect blocks on/off by touching the corresponding **icons**.
 - > Use the **Level** control to adjust the level of each effect block inside the Mic Preset.
 - > Use the **Delay/Reverb > Level** control to adjust the level of the Delay and Reverb blocks at the same time.
 - > Use the **Lead to Mod/Delay/Rev** controls to adjust the level of the lead voice going into the corresponding effect.
 - > Use the **HRM/D to Mod/Delay/Rev** controls to adjust the level of the harmony/double voices going into the corresponding effect.
 - > Use the **Mod to Delay** control to adjust the level of the Mod effect going into the Delay.
 - > Use the **Delay to Rev** control to adjust the level of the Delay effect going into the Reverb.

Adjusting the microphone input to your voice

You can globally adjust the level of the singer's voice against the effects. This will balance the particular voice, without altering the internal balance of the Mic Preset.

- 1 Go to the **Settings > Menu > Mic Setup > Setup** page.

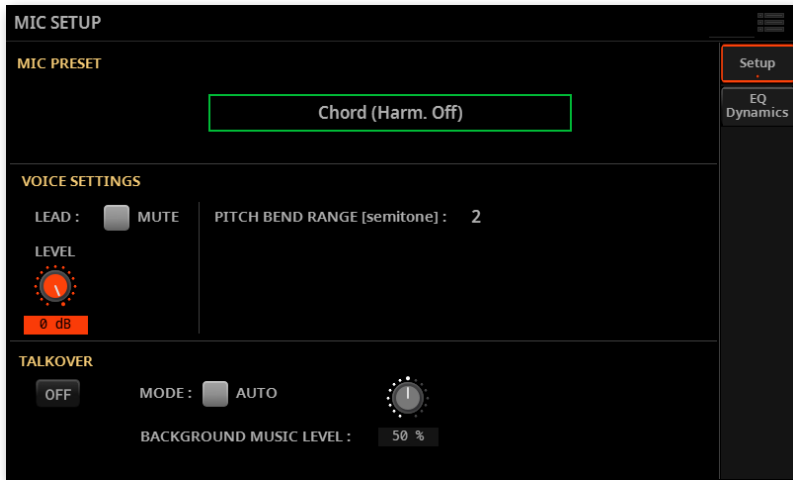

- 2 Adjust the Voice Settings parameters.
 - > Use the **Voice Settings > Lead > Level** knob to adjust the volume of the lead voice.
 - > If you want, select the **Mute** checkbox to exclude the direct lead voice signal from the mix. Only the effected part will remain.
- 3 Press the **EXIT** button, the return to the **Home > Menu > Mic Preset** page.

Saving the Mic Presets

After editing, you can save all the edited parameters into a User Mic Preset location in memory.

NOTE: Changes can only be saved onto User Mic Presets.

1 While in the **Mic Preset** page, choose the **Save Mic Preset** command from the **page menu** (☰) to open the **Save Mic Preset** dialog.

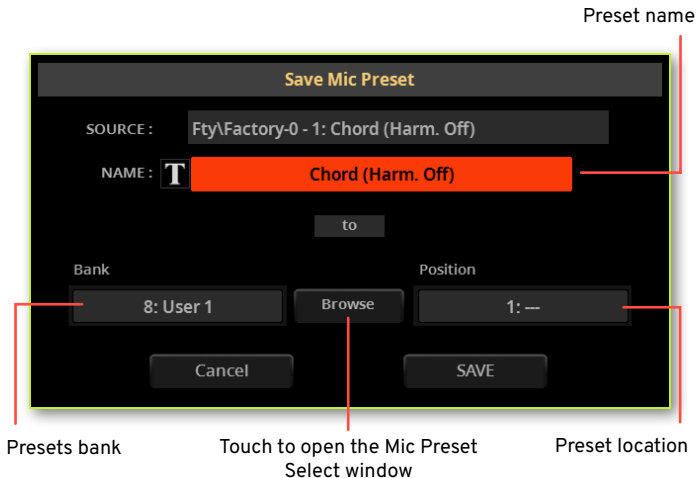

2 You may change the **name** of the Preset. Touch the **Text Edit (T)** button to open the **virtual keyboard** and edit the name.

When done editing the name, confirm by touching the **OK** button under the virtual keyboard.

3 When back at the **Save Mic Preset** dialog, if you want to save onto a different location touch the **Browse** button and open the **Mic Preset Select** window. The Presets are organized in a rigid grid. Choose a location as if you were choosing a Preset. Blank locations are shown as a series of dashes ('---').

4 When back at the **Save Mic Preset** dialog, confirm the Save operation by touching the **Save** button.

CAUTION: If you write over an existing Mic Preset, the existing Preset will be deleted. Please save on a storage device any User Presets you don't want to lose.

34

Effects for the Guitar

Editing the Guitar Presets

Accessing Guitar Preset page

You can edit and save the User Guitar Presets. Factory Guitar Presets are protected. If you access editing with a Factory Guitar Preset, a temporary copy is automatically created in memory.

- 1 While in the **Home** mode, press the **MENU** button to see the **Home Edit** menu.

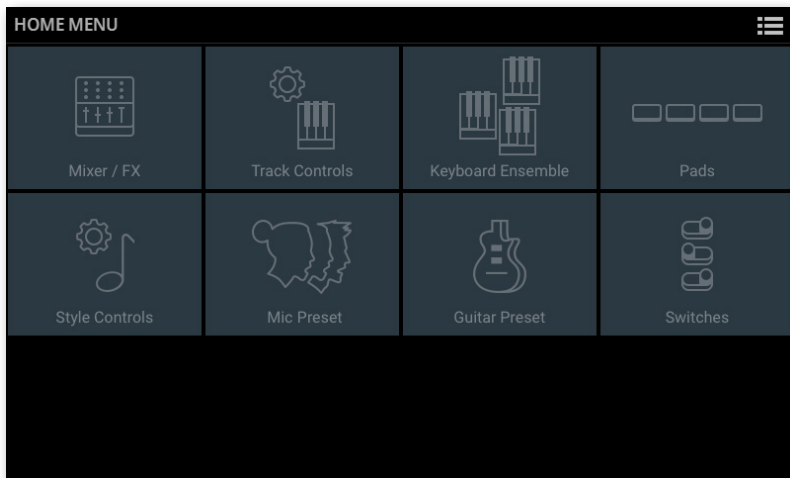

- 2 Touch the **Guitar Preset** button in the menu. The **Guitar Preset** page will appear.

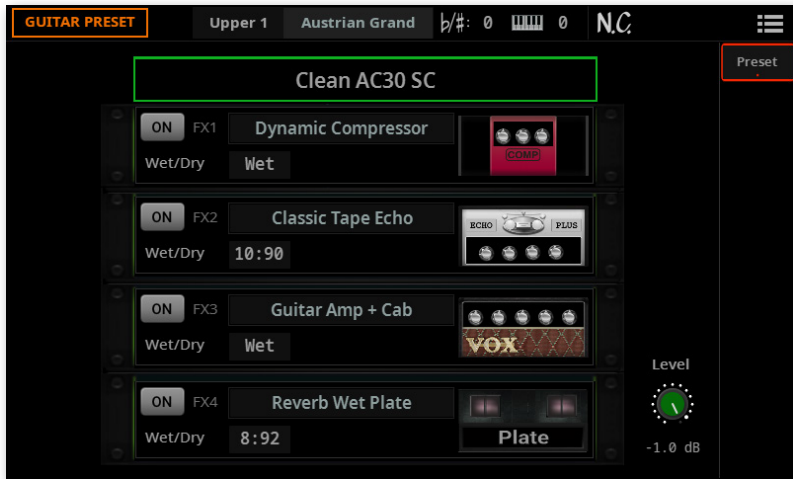

- 3 Press the **EXIT** button if you want to return to the **main Home** page.

Choosing, enabling and balancing the effects

While in the **Guitar Preset** page, you can choose a Guitar Preset, turn on/off the various effect blocks, choose the effects for each block, and adjust the general volume of the Preset.

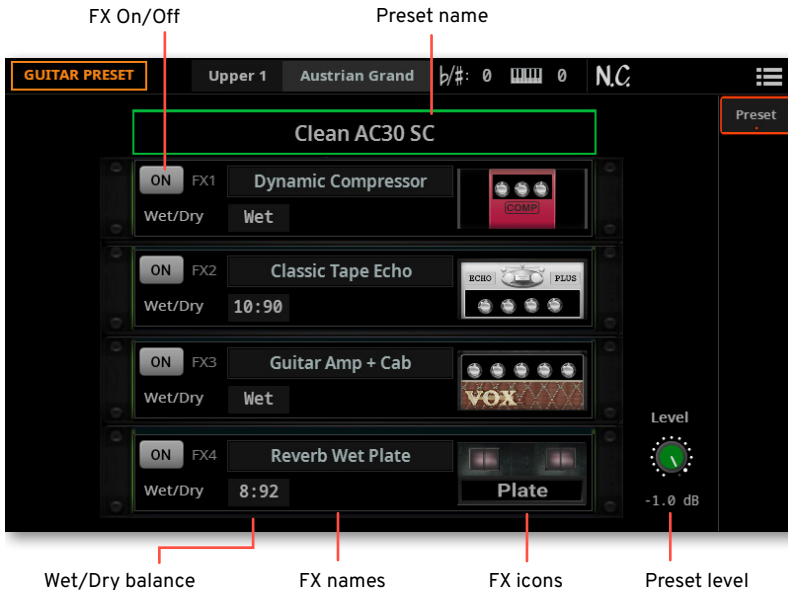

- > Touch the **name of the Preset** to choose a different Guitar Preset.
- > Use the **On/Off** button to turn the effect block on/off. These switches are also found in all the effect editing pages.
- > Touch the **name or icon of an effect** to open the **FX Edit** window and choose a different effect for that block. Press the **EXIT** button to return to this page.
- > Adjust the **Wet/Dry** mix to balance between the effect (Wet) and the direct (Dry) component of each block's audio signal.
- > Use the **Level** parameter to adjust the general level of the Preset.

Editing the Guitar effects

While in the **Guitar Preset** page, you can edit each of the effects in the blocks.

- 1 Touch the **name or icon of an effect** to open the **FX Edit** window for that block.

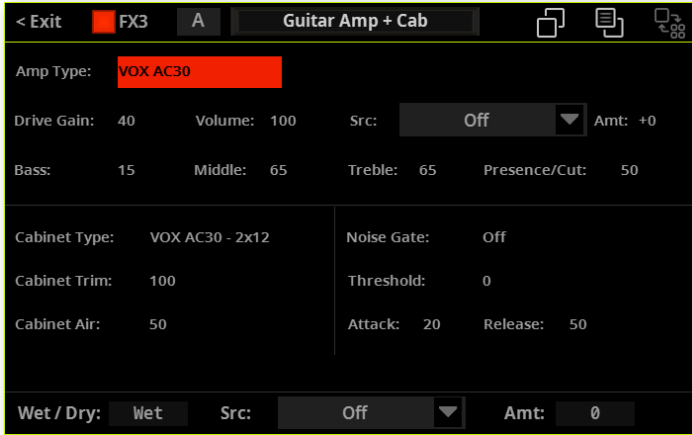

- 2 Edit the parameters. The effects are the same you can assign to the Sounds. For details, please see [Effects for the Sounds](#) on page 1007.
- 3 When done, press the **EXIT** button to return to the **Guitar Preset** page.

Saving the Guitar Presets

After editing, you can save all the edited parameters into a User Guitar Preset location in memory.

NOTE: Changes can only be saved onto User Guitar Presets.

1 While in the **Guitar Preset** page, choose the **Save Guitar Preset** command from the **page menu** () to open the **Save Guitar Preset** dialog.

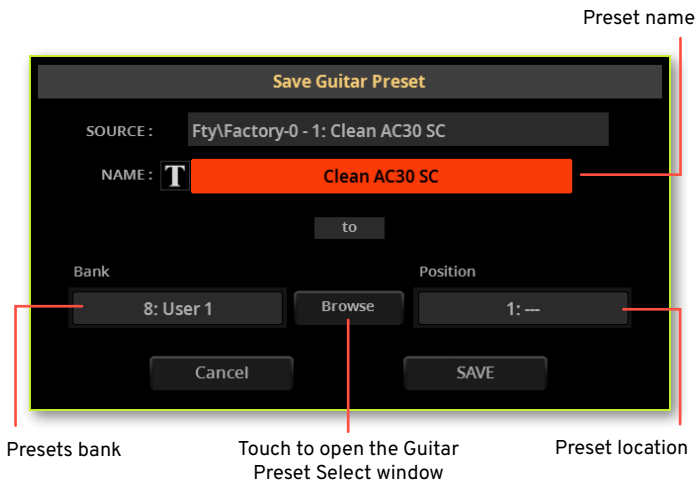

2 You may change the **name** of the Preset. Touch the **Text Edit (T)** button to open the **virtual keyboard** and edit the name.

When done editing the name, confirm by touching the **OK** button under the virtual keyboard.

3 When back at the **Save Guitar Preset** dialog, if you want to save onto a different location touch the **Browse** button and open the **Guitar Preset Select** window. The Presets are organized in a rigid grid. Choose a location as if you were choosing a Preset. Blank locations are shown as a series of dashes ('---').

4 When back at the **Save Guitar Preset** dialog, confirm the Save operation by touching the **Save** button.

CAUTION: If you write over an existing Guitar Preset, the existing Preset will be deleted. Please save on a storage device any User Presets you don't want to lose.

35

Effects for the Sounds

Editing the effects

The FX processors

In Pa5X, Sounds are sent to the **Insert (IFX)** and **Master (MFX) Effects**. The routing can be done in the **Mixer/FX** pages, both in the **Home** and the **Edit** modes. All of them can be edited.

A selection of the effects described in this chapter can also be used in the **Mic Presets** and the **Guitar Presets**.

Accessing the insert effects (IFX)

1 Go to the **Home > Menu > Mixer/FX > Insert FX** page. You can also access this section from the **Style/Song Edit > Menu**.



- 2 Touch the **TRACK SELECT** button to switch between the Sounds of the Keyboard and Pads, and the ones of the Style or the MIDI Song.
- 3 Use the **On/Off** buttons to enable or disable the Insert Effects.
- 4 Touch the **icon of the effect type** to open the **FX Edit** window.



Accessing the master effects (MFX)

1 Go to the **Home > Menu > Mixer/FX > Master FX** page. You can also access this section from the **Style/Song Edit > Menu**.



2 Use the **On/Off** button to enable or disable the Master Effects.

Please keep in mind that the Master Effects are assigned to all the Sounds of the same group. **FX Group A** is assigned to the Style and MIDI Song Sounds; **FX Group B** is assigned to Keyboard and Pad Sounds (but can also be assigned to selected MIDI Song Sounds).

3 Touch the **icon of the effect type** to open the **FX Edit** window.



Accessing the Mic or Guitar effects

Some of the effects used in the Mic and Guitar Presets are the same as the ones used for the Sounds. The voice-specific effects are different than the ones described in this chapter, and are described in the dedicated chapter.

- 1 Go to the **Home > Menu > Mic/Guitar Preset > Preset** page.

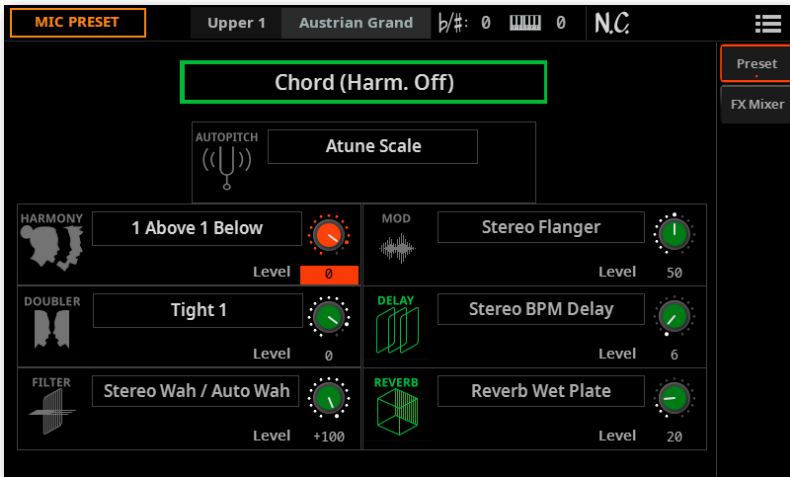

- 2 Touch the **name of the effect** to open the **FX Edit** window.

Editing the effects

The **FX Edit** window may change, depending on the type of effect in edit.

- > Compressor used as an Insert FX:

FX processor: IFX1

FX group: A

Selected FX: Stereo Compressor

Copy/paste commands: Copy, Paste, Zoom

Zoom: Zoom icon

Envelope Select: L/R Individually

Sensitivity: 30

Attack: 80

Pre LEQ Fc: Mid-Low

Pre LEQ Gain [dB]: -1.0

EQ Trim: 100

Pre HEQ Fc: High

Pre HEQ Gain [dB]: -2.0

Output Level: 26

REDUCTION: In, Gain, Out

Src: Off

Amt: +0

Wet / Dry: Wet

Src: Off

Amt: 0

FX mix and modulation

FX parameters

- > Reverb used as a Master FX:

FX processor: FX1

FX group: A

Selected FX: O-verb

Copy/paste commands: Copy, Paste, Zoom

Zoom: Zoom icon

PRE DELAY: 90

SIZE: 100

DECAY: 30

DIFFUSION: 88

Wet / Dry: Wet

Src: Off

Amt: 0

FX mix and modulation

FX parameters

- 1 Depending on the selected effect, you can touch the **Zoom In** () button to see the detailed parameters of the effect.



- 2 Touch the **Zoom Out** () button to return to the main parameters of the effect.
- 3 Touch the **name of the selected effect** on top of the dialog to open the FX Select window, and choose an effect.
- 4 If needed, edit the various parameters, as described in the following pages.
- 5 You can adjust the **Wet/Dry** mix of the effects. With master effects, it is advisable to leave the mix all Wet, and use the individual mixer channels' send level for mixing the dry and wet signals (as explained below).
- 6 When finished editing, press the **EXIT** button to return to the previous page.

Choosing a Dynamic Modulation Source (DMS)

You can modulate one of the effect parameters by using MIDI messages generated by the internal physical controllers or by MIDI data recorded in one of the Style or Song tracks.

■ Choose the modulation track

- > With insert effects, the modulation is always received from the track they are assigned to. For example, if the insert effect is assigned to the Upper 1 Sound, it will be modulated by the Upper 1 Sound.
- > With master effects, you must choose a modulating track. Go to the **Home > Menu > Mixer/FX > Master FX** page containing the master effect you want to edit. You can also access this section from the **Style/Song Edit > Menu**. Use the **Mod. (Modulating Track)** parameter to choose the modulating Sound/part/track.



■ Choose the modulation source

- > While in the **FX Edit** page (for both the insert or master effects), use the **Src (Source)** parameter to choose the physical controller or the type of MIDI data that will modulate the effect.

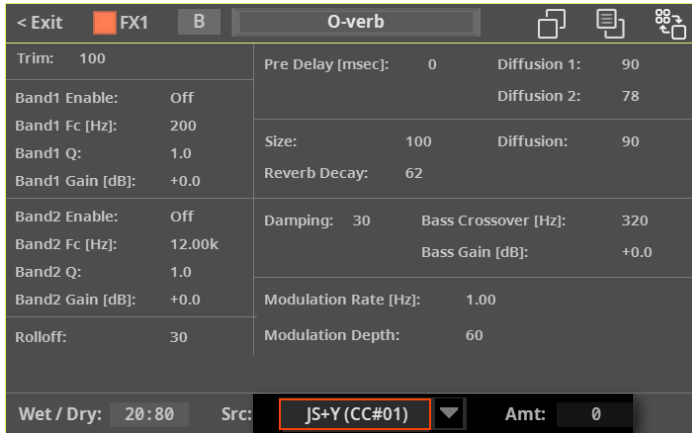

Pa5X uses the Dynamic Modulation Source (DMS) system, a highly flexible and powerful matrix of modulation. See below a list of available sources.

DMS	Note
Off	No modulation
Gate1	
Gate1+Dmpr	Gate 1 + Damper
Gate2	
Gate2+Dmpr	Gate 2 + Damper
Note Nr	Note Number
Velocity	Note Velocity
Expo Velocity	Exponential Note Velocity
After Touch	After Touch
JS X	Joystick Left/Right
JS+Y (CC#01)	Joystick Forward
JS-Y (CC#02)	Joystick Backward
MIDI (CC#04)	
MIDI (CC#12)	FX MIDI Controller 1
MIDI (CC#13)	FX MIDI Controller 2
Ribb. (CC#16)	Ribbon Controller
MIDI (CC#18)	
MIDI (CC#17)	
MIDI (CC#19)	

DMS	Note
MIDI (CC#20)	
MIDI (CC#21)	
MIDI (CC#17+)	
MIDI (CC#19+)	
MIDI (CC#20+)	
MIDI (CC#21+)	
Damper (CC#64)	
Porta.SW (CC#65)	Portamento Switch
Sostenuto (CC#66)	Sostenuto Pedal
MIDI (CC#67)	
MIDI (CC#80)	
MIDI (CC#81)	
MIDI (CC#82)	
MIDI (CC#83)	
MIDI (CC#85)	
MIDI (CC#86)	
MIDI (CC#87)	
MIDI (CC#88)	
Tempo	

■ Notes about the Gate modulation sources

Gate 1+Dmpr is at maximum during note-on, and will stop when all keys are released. The effect will remain at maximum even after the keys are released, as long as the damper (sustain) pedal is pressed.

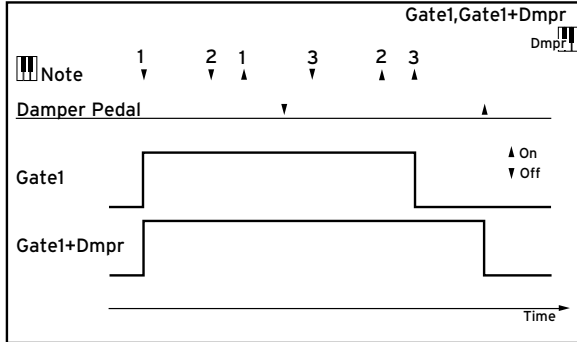

Gate2, Gate2+Dmpr (Gate2+Damper) is essentially the same as for Gate 1 or Gate 1 + Dmpr. However when Gate 2 or Gate 2 + Dmpr are used as a dynamic modulation source for the Envelope Generator, a trigger will occur at each note-on. (In the case of Gate 1 and Gate 1 + Dmpr, the trigger occurs only for the first note-on.)

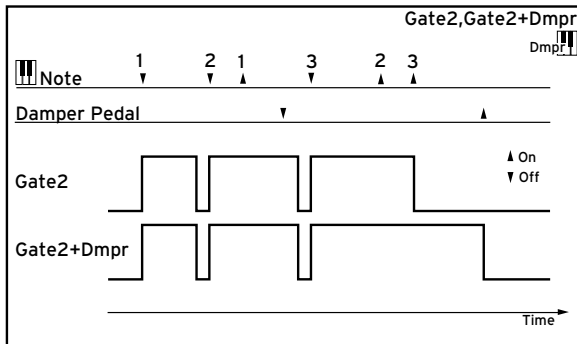

■ Set the modulation intensity

> While in the **FX Edit** page (for both the insert or master effects), use the **Amt (Amount)** parameter to set the intensity of modulation. This is an offset to the normal value received from the source.

Adapting the reverb to the room size

Pa5X includes a master offset for all the reverbs. Use it to adjust reverb tails to the room where you are playing. Use negative values when you are in a very reverberant room, positive values if the room is too dry.

- 1 Go to the **Global > General Controls > Basic** page.

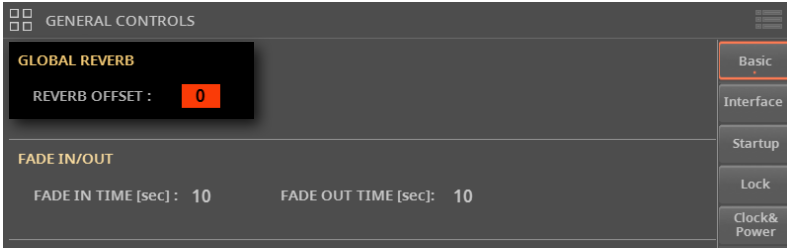

- 2 Use the **Reverb Offset** parameter to change the reverb master.

Reverb Offset	Meaning
-50 ... +50	Value subtracted or added to the reverb length.

Effects list

The following list contains all the Factory Effects. Detailed information on each effect's parameter are contained in the following pages.

Amplifier

OD / Hi Gain + Wah
 Stereo Guitar Cab
 Stereo Bass Cab
 Bass Amp Model
 Bass Amp + Cab
 Tube PreAmp Model
 Stereo Tube Pre Amp
 Mic Model + Pre Amp
 Comp + Amp Sim
 Comp + OD / Hi Gain
 OD / HG + Amp Sim
 Wah + Amp Sim
 Decimator + Amp
 Amp Sim + Tremolo
 OD / HyperGain + Wah
 Guitar Amp + P4EQ
 Bass Tube Amp + Cab
 Stereo Mic + Pre Amp
 Amp Clean Combo
 Amp California
 Amp Tweed
 Amp Modded OD
 Guitar Cab + NR
 Guitar Amp + Cab
 Amp Clean Combo + Cab
 Amp California + Cab
 Amp Tweed + Cab
 Amp Modded OD + Cab
 CX-3 Amp

Delay

L/C/R Delay
 Stereo/Cross Delay
 Stereo Multitap Delay
 Stereo Mod Delay

Stereo Dynamic Delay
 Stereo AutoPan Delay
 Tape Echo
 Sequence BPM Delay
 L/C/R BPM Delay
 Stereo BPM Delay
 Stereo BPM Multitap Delay
 Stereo BPM Mod Delay
 Stereo BPM AutoPan Delay
 Tape Echo BPM
 L/C/R Long Delay²
 Stereo/Cross Long Delay²
 Hold Delay²
 LCR BPM Long Delay²
 Stereo BPM Long Delay²
 Classic Tape Echo

Dynamics

Stereo Compressor
 Stereo Limiter
 Multiband Limiter
 Stereo Mastering Limiter
 Stereo Gate
 Stereo Multiband Limiter
 Dynamic Compressor

Filter

Stereo Parametric 4EQ
 Stereo 6 Band EQ³
 Stereo Graphic 7EQ
 Stereo Exciter / Enhancer
 Stereo Isolator
 Stereo Wah / Auto Wah
 Stereo Vintage Wah
 Stereo Random Filter
 Stereo Multi Mode Filter

Talking Modulator
 2 Voice Resonator
 P4EQ + Exciter
 P4EQ + Wah
 Vocoder³
 VOX Wah
 VOX Treble Booster

Frequency

Stereo Sub Oscillator
 Grain Shifter
 Detune
 Pitch Shifter
 Pitch Shifter BPM
 Pitch Shift Mod.
 Stereo Pitch Shifter²
 Stereo Pitch Shifter BPM²

Mixed

Stereo Decimator
 Stereo Analog Record
 Doppler
 Scratch
 Auto Reverse
 P4EQ + Chorus/Flanger
 P4EQ + Phaser
 P4EQ + Multitap Delay
 Compressor + Wah
 Compressor + P4EQ
 Compressor + Chorus/Flanger
 Compressor + Phaser
 Compressor + Multitap Delay
 Limiter + P4EQ
 Limiter + Chorus/Flanger
 Limiter + Phaser
 Limiter - Multitap Delay

Exciter + Compressor
 Exciter + Limiter
 Exciter + Chorus/Flanger
 Exciter + Phaser
 Exciter - Multitap Delay
 OD / HG + Cho/FIng
 OD / HG + Phaser
 OD / HG + Mt.Delay
 Decimator + Compressor
 Chor/Flang +MultitapDelay
 PianoBody / Damper
 Multitap Chorus/Delay
 Stereo Limiter+6BandEQ³

Modulator

Stereo Chorus
 Stereo Harmonic Chorus
 Stereo Biphase Mod
 Multitap Chorus / Delay
 Ensemble
 Polysix Ensemble
 Stereo Flanger

Stereo Random Flanger
 Stereo Envelope Flanger
 Stereo Phaser
 Stereo Random Phaser
 Stereo Envelope Phaser
 Stereo Vibrato
 Stereo Auto Fade Mod.
 Stereo Tremolo
 Stereo Envelope Tremolo
 Stereo Auto Pan
 Stereo Phaser + Tremolo
 Stereo Ring Modulator
 Organ Vibrato / Chorus
 Rotary Speaker
 Phaser + Chorus/Flanger
 Rotary Speaker OD
 U-Vibe
 Orange Phaser
 Small Phaser
 Classic Chorus
 Classic Flanger
 Classic Tremolo

Black Chorus / Flanger
 CX-3 Rotary Speaker

Reverb

Reverb Hall
 Reverb Smooth Hall
 Reverb Wet Plate
 Reverb Dry Plate
 Reverb Room
 Reverb Bright Room
 Early Reflections
 Reverb Gate
 Early Reflections Hi Dens²
 Reverb Spring
 ToneLab Reverb Room
 O-verb¹

Note:

- 1: MFX1 only
- 2: MFX2-3 only
- 3: IFX only

Effect parameters

Amplifier

Pa5X includes accurate guitar and bass amplifier and cabinet modeling. Some of the effects combine an amplifier and a cabinet model.

Modelling amplifiers

Pa5X comes with a wide selection of the best amps, that offer the widest possible array of great tones. The operating mode of the preamp and power amp, the response of the tone controls, and their placement within the circuit will change depending on the type of amp you select, precisely replicating the exact gain and tonal character of the original amp. The all-important power amp stage (class A or AB) and negative-feedback circuit (or lack thereof) are also carefully simulated.

The volume controls

Two main controls affect the volume (or gain) and at the same time the tone of the amp: **Drive** or **Drive Gain** (controlling the preamp gain and the amount of preamp distortion) and **Volume, Output** or **Out Level** (controlling the preamp output level). Each control has its own specific job, and the sound of a particular amp model can vary over a very wide range just depending on the settings of these controls.

In addition, the **Trim** or **Cabinet Trim** control (a power attenuator) is placed between the output of your amp and the input of your speaker cabinet. At the end of the signal path, the **Wet/Dry** parameter in the **FX Edit** page, and the **Master** knob in the **Mixer/FX > MFX Send** page, control the level of the final mix and allows you to balance all your presets to each other.

We have made the relationship between preamp and power amp work in the same way as in the original amps. Therefore, to obtain truly authentic tones, please use the Pre/Drive Gain parameter to control the preamp distortion, and the Volume parameter to control the distinctive distortion and warmth of the power amp stage.

Be advised that setting the Drive Gain too high will result in heavy distortion, and is not recommended.

Tube talk

‘Tubes’ is the name adopted in the USA, while ‘valves’ is the British equivalent. As all the amps we’ve modelled come from one of the two countries just mentioned, we will use the corresponding term in the following descriptions.

Also, please note that an ECC83 preamp valve is the British version of a 12AX7 preamp tube used in the USA.

Modelling speaker cabinets

The accurate amp models can be paired with speaker cabinet models of the same quality. The output stage of a tube amp works in close harmony with the varying impedance curve of the speaker(s) it is driving. This intimate and vital relationship plays a major role in producing the warm, punchy sound and pleasing feel of tube amps.

Modelling a speaker cabinet is not just a case of frequency response, but is a combination of frequency response, transient response (how a speaker reacts to the strength of how a note is played), and the all-important interaction of the amps output to the speaker’s impedance curve. In addition, other vitally important factors that have to be taken into account when modelling a cabinet are the actual physical dimensions of the enclosure (cabinet), the unique tonality of said enclosure (which will be affected by both the type and thickness of the wood it is made of) and whether it boasts an open, semi-open or closed-back design.

Amplifier types

These are the available amplifier types.

Amp Type	Meaning
VOX AC15	VOX AC15 manufactured in 1962
VOX AC15TB	VOX AC15TB (an AC15 modified by the addition of a top boost circuit).
VOX AC30	Normal channel of a VOX AC30TB
VOX AC30TB	Brilliant channel of a VOX AC30TB
UK BLUES	UK-manufactured vintage stack amp head
UK 70'S	High treble channel of a UK-manufactured 100W amp head from 1969
UK 80'S	UK-manufactured 100 Watt head from 1983
UK 90'S	Lead channel of a 100W dual channel head
UK MODERN	UK-manufactured 100W modern amp
US MODERN	High-gain amp with metal plate
US HIGAIN	1991 model 100W amp head covered in snake-skin
BOUTIQUE OD	Overdrive channel of a high-end 100W hand made amp
BOUTIQUE CL	Clean channel of a high-end, hand-made 100W amp
BLACK 2x12	2x12 combo amp indispensable for country or blues players
TWEED - 1x12	Combo amp covered in tweed cloth
TWEED - 4x10	4x10 combo amp designed for bass guitar
6L6	Generic US amps
EL84	Generic VOX amps
EL34	Generic UK amps
SS	Generic Solid State amps

Cabinet types

When a cabinet can be chosen, these are the available types.

Cabinet Type	Meaning
TWEED - 1x12	Open-back cabinet with one 12" Alnico magnet speaker, typically used for blues. It is usually paired with the Tweed Amp.
TWEED - 4x10	Open-back cabinet with four 10" 8 Ohm Alnico magnet speakers, wired in parallel for a total of 2 Ohms impedance.
BLACK - 2x10	Open-back cabinet with two 10" ceramic magnet 35 Watt speakers.
BLACK - 2x12	American open-back cabinet with two 12" ceramic magnet speakers. They are 8 Ohm units wired in parallel for a 4 Ohm total load.
VOX AC15 - 1x12	VOX AC15 open-back cabinet with one 12" VOX Blue Alnico speaker, manufactured by Celestion in Ipswich, England.
VOX AC30 - 2x12	VOX AC30 open-back cabinet with two 12" VOX Blue Alnicos, wired in series for 16 Ohms.
VOX AD412 - 4x12	VOX AD412 closed-back cabinet with four 12" custom-designed Celestion speakers with Neodymium magnets.
UK H30 - 4x12	Closed-back classic cabinet with four 30W 12" speakers. Made in the late '60s by the same famous UK amp company as the UK T75 4x12.
UK T75 - 4x12	Closed-back cabinet loaded with four modern 75W 12" British speakers.
US V30 - 4x12	Closed-back cabinet with four 30W 12" speakers. This big cabinet uses four UK made Vintage named speakers and is known for its deep bass and high end detail.

Amp + Cabinet combinations

These are the recommended combinations of guitar amp models and cabinet simulators:

Amp Type	Cabinet Type
VOX AC15	VOX AC15 - 1x12
VOX AC15TB	VOX AC15 - 1x12
VOX AC30	VOX AC30 - 2x12
VOX AC30TB	VOX AC30 - 2x12
UK BLUES	UK H30 - 4x12
UK 70'S	UK H30 - 4x12
UK 80'S	UK T75 - 4x12
UK 90'S	UK T75 - 4x12
UK MODERN	UK T75 - 4x12, US V30 - 4x12
US MODERN	US V30 - 4x12
US HIGAIN	US V30 - 4x12, UK T75 - 4x12
BOUTIQUE OD	UK H30 - 4x12
BOUTIQUE CL	UK H30 - 4x12
BLACK 2x12	BLACK - 2x12
TWEED - 1x12	TWEED - 1x12
TWEED - 4x10	TWEED - 4x10

OD / Hi Gain + Wah

This distortion effect utilizes an Overdrive mode and a Hi-Gain mode. Controlling the wah effect, the 3-band EQ, and the amp simulation will allow you to create versatile distortion sounds. This effect is suitable for guitar and organ sounds.

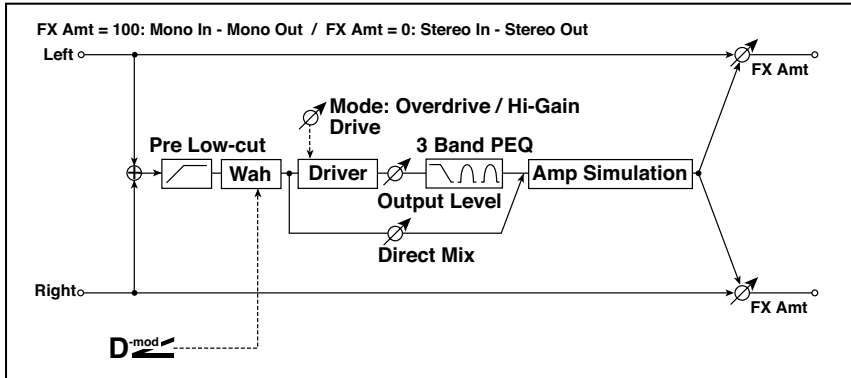

a	Wah	Off, On	Switches Wah on/off
	Src	Off...Tempo	Selects the modulation source that switches the Wah on and off
	Sw	Toggle, Moment	Selects the switching mode for the modulation source that switches the Wah on and off
b	Wah Sweep Range	-10...+10	Sets the range of Wah
	Wah Sweep Src	Off...Tempo	Selects the modulation source that controls the Wah
c	Drive Mode	Overdrive, Hi-Gain	Switches between overdrive and hi-gain distortion
	Drive	1...100	Sets the degree of distortion
e	Pre Low-cut	0...10	Sets the low range cut amount of the distortion input
	Output Level	0...50	Sets the output level
	Src	Off...Tempo	Selects the modulation source for the output level
f	Amt	-50...+50	Sets the modulation amount of the output level
	Low Cutoff [Hz]	20...1.00k	Sets the center frequency for Low EQ (shelving type)
	Gain [dB]	-18...+18	Sets the gain of Low EQ

g	Mid1Cutoff [Hz]	300...10.00k	Sets the center frequency for Mid/High EQ 1 (peaking type)
	Q	0.5...10.0	Sets the band width of Mid/High EQ 1
	Gain [dB]	-18...+18	Sets the gain of Mid/High EQ 1
h	Mid2 Cutoff [Hz]	500...20.00k	Sets the center frequency for Mid/High EQ 2 (peaking type)
	Q	0.5...10.0	Sets the band width of Mid/High EQ 2
	Gain [dB]	-18...+18	Sets the gain of Mid/High EQ 2
i	Direct Mix	0...50	Sets the amount of the dry sound mixed to the distortion
	Speaker Simulation	Off, On	Switches the speaker simulation on/off
j	Wet/Dry	Dry, 1:99...99:1, Wet	Balance between the wet and dry signal
	Src	Off...Tempo	See the list of DMS (Dynamic Modulation Sources) at the beginning of this part
	Amt	-100...+100	Amount of modulation source

■ a: Wah

The Wah parameter switches the wah effect on/off.

■ a: Sw

This parameter sets how the wah effect is switched on and off via the modulation source.

When “Sw” = Moment, the wah effect is usually turned off. It is turned on only when you press the pedal or operate the joystick.

MIDI When a value for the modulation source is less than 64, “off” speed is selected, and when the value is 64 or higher, “on” is selected.

When “Sw” = Toggle, the wah effect is switched between on and off each time you press the pedal or operate the joystick.

MIDI The switch will be turned on/off each time the value of the modulation source exceeds 64.

- **b: Wah Sweep Range**

- **b: Wah Sweep Src**

This parameter sets the sweep range of the wah center frequency. A negative value will reverse the direction of sweep. The wah center frequency can be controlled by the modulation source specified in the “Wah Sweep Src” parameter.

- **d: Pre Low-cut**

Cutting the signal in the low range before it is input to the Distortion will create a sharp distortion.

- **d: Drive**

- **e: Output Level**

The degree of distortion is determined by the level of input signal and the setting of “Drive”. Raising the “Drive” setting will cause the entire volume level to increase. Use the “Output Level” parameter to adjust the volume level. The “Output Level” parameter uses the signal level input to the 3-Band EQ. If clipping occurs at the 3-Band EQ, adjust the “Output Level” parameter.

Stereo Guitar Cab

This simulates the acoustical character of a guitar amp's speaker cabinet.

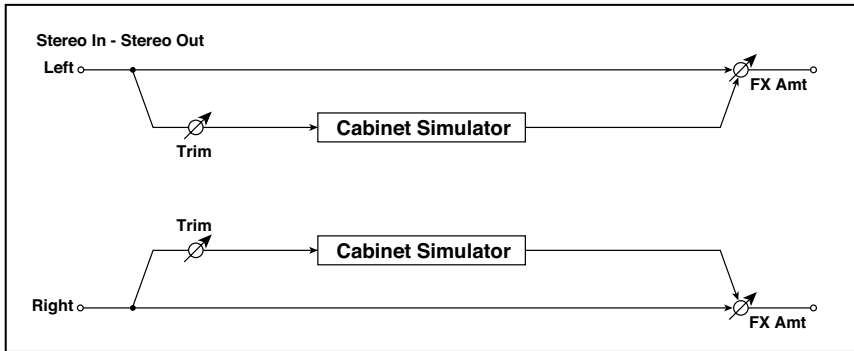

a	Trim	0...100	Sets the input level
b	Type	TWEED - 1x12, TWEED - 4x10, BLACK - 2x10, BLACK - 2x12, VOX AC15 - 1x12, VOX AC30 - 2x12, VOX AD412 - 4x12, UK H30 - 4x12, UK T75 - 4x12, US V30 - 4x12	Selects the cabinet type
c	Air	0...100	Sets the mic position
d	Wet/Dry	Dry, 1:99...99:1, Wet	Balance between the wet and dry signal
	Src	Off...Tempo	See the list of DMS (Dynamic Modulation Sources) at the beginning of this part
	Amt	-100...+100	Amount of modulation source

Stereo Bass Cab

This simulates the acoustical character of a bass amp’s speaker cabinet.

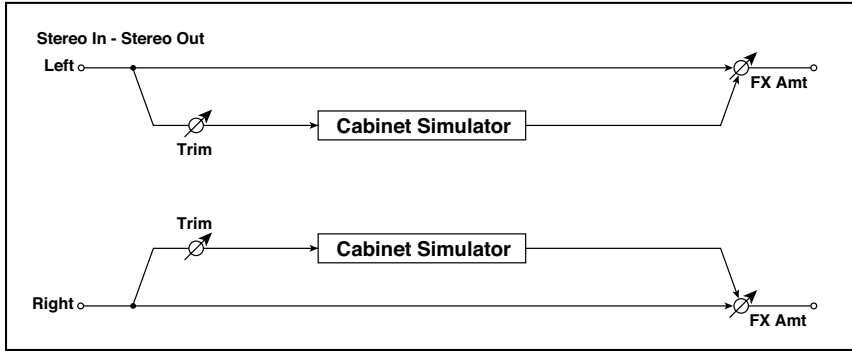

a	Trim	0...100	Sets the input level
b	Cabinet Type		Selects the cabinet type
		LA - 4x10	Four 10" speakers / LA sound cabinet
		MODERN - 4x10	Four 10" aluminum-cone speakers / modern cabinet
		METAL - 4x10	Four 10" aluminum-cone speakers / modern cabinet
		CLASSIC - 8x10	Eight 10" speakers / classic cabinet
		UK - 4x12	Four 12" speakers / UK-manufactured cabinet
		STUDIO - 1x15	One 15" speaker / studio combo cabinet
		JAZZ - 1x15	One 15" speaker / jazz combo cabinet
		VOX AC100 - 2x15	Two 15" speakers / cabinet for Vox AC100
		US - 2x15	Two 15" speakers / US-manufactured cabinet
		UK - 4x15	Four 15" speakers / UK-manufactured cabinet
			LA - 1x18
	COMBI - 1x12 & 1x18	One 12" and one 18" speaker combination cabinet	
c	Wet/Dry	Dry, 1:99...99:1, Wet	Balance between the wet and dry signal
	Src	Off...Tempo	See the list of DMS (Dynamic Modulation Sources) at the beginning of this part
	Amt	-100...+100	Amount of modulation source

Bass Amp Model

This simulates a bass amp.

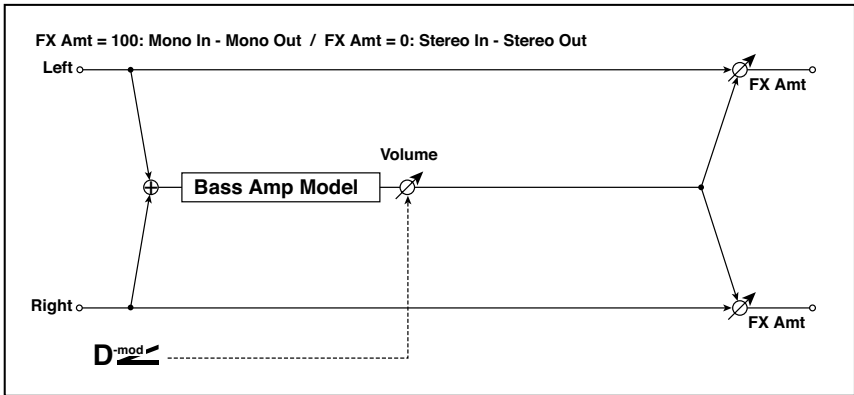

a	Amp Type		Selects the amplifier type
	LA STUDIO		An amp that is typical of the LA sound.
	JAZZ		A combo amp favored by jazz bassists.
	GOLD PANEL		An amp distinctive for its eye-catching gold panel and clean sound.
	SCOOPED		An amp typical of 80's sounds.
	VALVE2		A tube amp suitable for rock.
	VALVE		A tube amp with the ULTRA LO switch turned ON.
	CLASSIC		A tube amp whose basic character changes according to the setting of the value dial.
b	Volume	0...100	Sets the output level
	Src	Off...Tempo	Selects the modulation source for the output level
	Amt	-100...+100	Sets the modulation amount of the output level
c	Bass	0...100	Sets the bass (low range) level
d	Middle	0...100	Sets the middle (mid range) level
	Mid Range	0...4	Sets the mid-frequency range
e	Treble	0...100	Sets the treble (high range) level
f	Presence	0...100	Sets the presence (high-frequency tone)

g	Wet/Dry	Dry, 1:99...99:1, Wet	Balance between the wet and dry signal
	Src	Off...Tempo	See the list of DMS (Dynamic Modulation Sources) at the beginning of this part
	Amt	-100...+100	Amount of modulation source

Bass Amp + Cab

This simulates a bass amp and speaker cabinet.

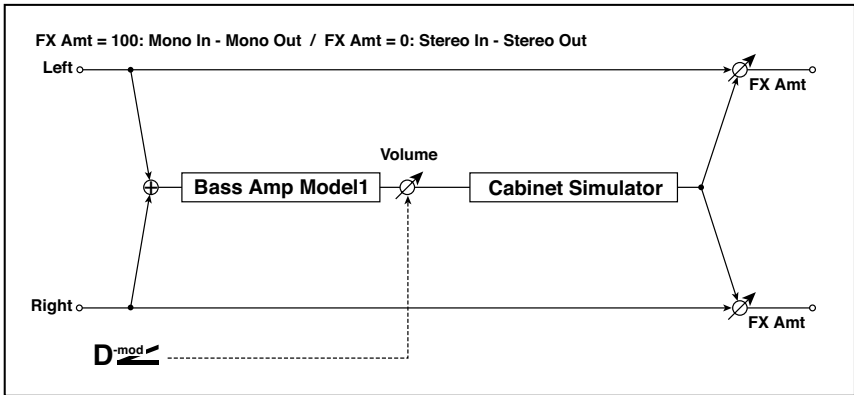

a	Amp Type	LA STUDIO, JAZZ, GOLD PANEL, SCOOPED, VALVE2, VALVE, CLASSIC	Selects the type of the amplifier
b	Volume	0...100	Sets the output level
	Src	Off...Tempo	Selects the modulation source for the output level
	Amt	-100...+100	Sets the modulation amount of the output level
c	Bass	0...100	Sets the bass (low range) level
d	Middle	0...100	Sets the middle (mid range) level
	Mid Range	0...4	Sets the mid-frequency range
e	Treble	0...100	Sets the treble (high range) level
f	Presence	0...100	Sets the presence (high-frequency tone)
g	Cabinet Simulator	Off, On	Switches the cabinet simulator on/off
h	Cabinet Type	LA - 4x10, MODERN - 4x10, METAL - 4x10, CLASSIC - 8x10, UK - 4x12, STUDIO - 1x15, JAZZ - 1x15, VOX AC100 - 2x15, US - 2x15, UK - 4x15, LA - 1x18, COMBI - 1x12 & 1x18	Selects the cabinet type

i	Wet/Dry	Dry, 1:99...99:1, Wet	Balance between the wet and dry signal
	Src	Off...Tempo	See the list of DMS (Dynamic Modulation Sources) at the beginning of this part
	Amt	-100...+100	Amount of modulation source

- **a: Amp Type**

- **h: Cabinet Type**

This is the recommended combinations of Bass Amp Models and Cabinets:

Amp Type	Cabinet Type
LA STUDIO	LA - 4x10, LA - 1x18
JAZZ	JAZZ - 1x15
GOLD PANEL	MODERN - 4x10
SCOOPED	METAL - 4x10
VALVE2	CLASSIC - 8x10
VALVE	CLASSIC - 8x10
CLASSIC	COMBI - 1x12 & 1x18

Tube PreAmp Model

This effect simulates a two-stage vacuum tube preamp. You can make individual settings for two vacuum tubes connected in series. This lets you create the warm sound typical of vacuum tubes.

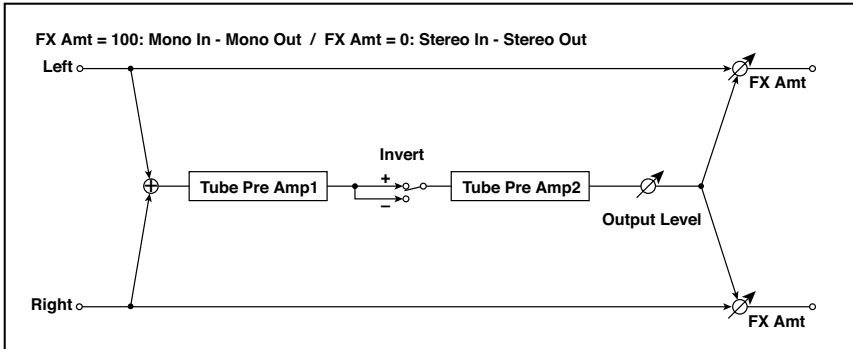

a	Tube1 Low Cut [Hz]	Thru, 21...8.00k	Sets the cutoff frequency for the low cut filter of stage 1
	High Cut [Hz]	53...20.00k, Thru	Sets the cutoff frequency for the high cut filter of stage 1
b	Tube1 Gain [dB]	-24.0...+24.0	Sets the input gain for stage 1
	Saturation [%]	0...100	Sets the input/output response for stage 1
c	Tube1 Bias	0...100	Sets the bias voltage for stage 1
d	Tube1 Phase	Normal, Wet Invert	Turns phase reversal on/off
e	Tube2 Low Cut [Hz]	Thru, 21...8.00k	Sets the cutoff frequency for the low cut filter of stage 2
	High Cut [Hz]	53...20.00k, Thru	Sets the cutoff frequency for the high cut filter of stage 2
f	Tube2 Gain [dB]	-24.0...+24.0	Sets the input gain for stage 2
	Saturation [%]	0...100	Sets the input/output response for stage 2
g	Tube2 Bias	0...100	Sets the bias voltage for stage 2
h	Tube2 Output Level [dB]	-48.0...+0.0	Sets the output level
i	Wet/Dry	Dry, 1:99...99:1, Wet	Balance between the wet and dry signal
	Src	Off...Tempo	See the list of DMS (Dynamic Modulation Sources) at the beginning of this part
	Amt	-100...+100	Amount of modulation source

■ b, f: Saturation [%]

With higher settings of this value, the waveform will change at high gain levels, tending to cause distortion. Lower settings of this value will produce linear response.

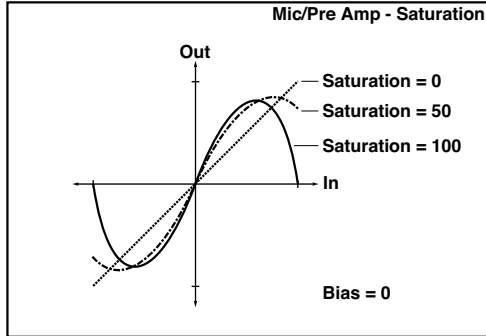

■ c: Tube1 Bias

This expresses the effect that changes in vacuum tube bias have on the distortion of the waveform. Higher settings of this value will produce distortion even at low gain levels. Since this will also change the overtone structure, you can use it to control the tonal character.

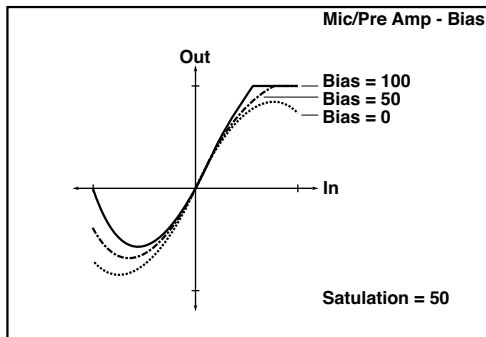

■ d: Tube1 Phase

With the Wet Invert setting, the phase of the signal will be inverted between stage 1 and stage 2. Since "Bias" is applied to the inverted signal in stage 2, this will change the tonal character.

Stereo Tube Pre Amp

This is a stereo vacuum tube preamp simulator (Tube PreAmp Model (Tube PreAmp Modeling)).

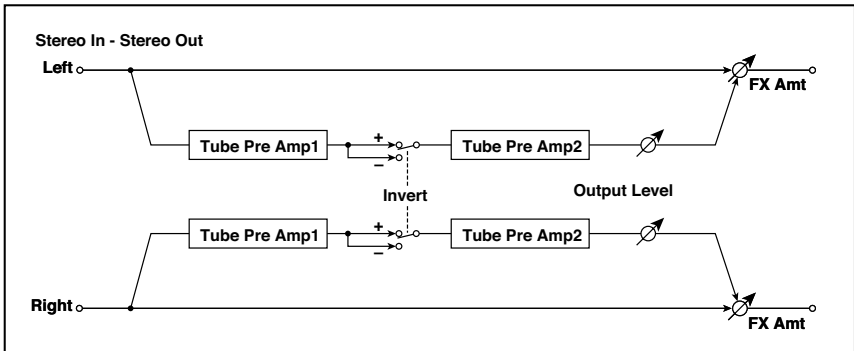

Mic Model+Pre Amp

This effect simulates a mic and vacuum tube preamp. You can choose from various types of mic and positions to create differing sonic characters.

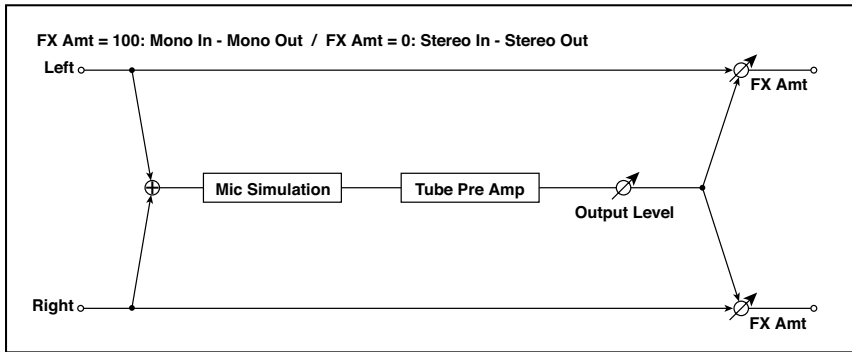

a	Mic Type	Vintage Dynamic, Multi Condenser, Percussion Condenser, Drums Dynamic, Vocal Dynamic, Multi Dynamic, Vocal Condenser, Vocal Tube, Kick Dynamic	Selects the type of mic
b	Mic Position	Close, On, Off, Far	Sets the mic placement distance
c	Tube Low Cut [Hz]	Thru, 21...8.00k	Sets the frequency of the low cut filter
	High Cut [Hz]	53...20.00k, Thru	Sets the frequency of the high cut filter
d	Tube Gain [dB]	-24.0...+24.0	Sets the input gain to the vacuum tube preamp
	Saturation [%]	0...100	Sets the input/output response of the preamp
e	Tube Bias	0...100	Sets the bias level of the preamp
f	Tube Output Level [dB]	-48.0...+0.0	Sets the output level of the preamp
g	Wet/Dry	Dry, 1:99...99:1, Wet	Balance between the wet and dry signal
	Src	Off...Tempo	See the list of DMS (Dynamic Modulation Sources) at the beginning of this part
	Amt	-100...+100	Amount of modulation source

■ **b: Mic Position**

This expresses the effect that the mic position has on the sound. The Close setting is the closest mic position, and the Far setting is the farthest.

Comp + Amp Sim

This effect combines a mono compressor and an amp simulation. You can change the order of the effects.

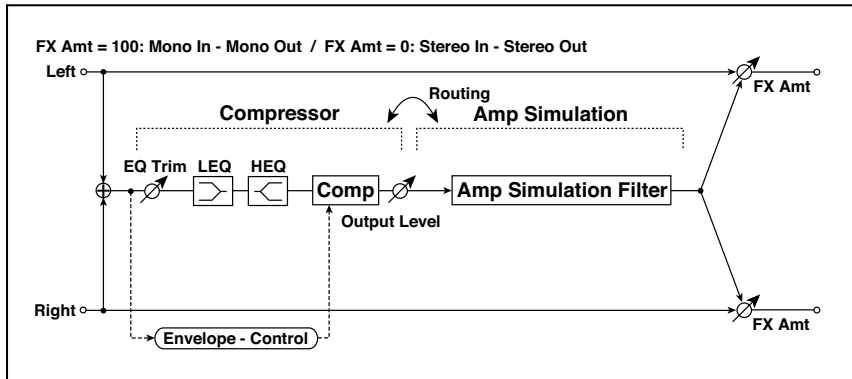

COMPRESSOR

a	[C] Sensitivity	1...100	Sets the sensitivity
b	[C]Attack	1...100	Sets the attack level
	Output Level	0...100	Sets the compressor output level
c	[C]EQ Trim	0...100	Sets the EQ input level
d	[C]Pre LEQ Gain [dB]	-15...+15	Sets the gain of Low EQ
	Pre HEQ Gain [dB]	-15...+15	Sets the gain of High EQ

AMP SIM

e	[A]Amplifier Type	SS, EL84, 6L6	Selects the type of guitar amplifier
f	Routing	Comp > Amp, Amp > Comp	Switches the order of the compressor and amp simulation
g	Wet/Dry	Dry, 1:99...99:1, Wet	Balance between the wet and dry signal
	Src	Off...Tempo	See the list of DMS (Dynamic Modulation Sources) at the beginning of this part
	Amt	-100...+100	Amount of modulation source

Comp + OD / Hi Gain

This effect combines a mono compressor and an overdrive/high-gain distortion. You can change the order of the effects.

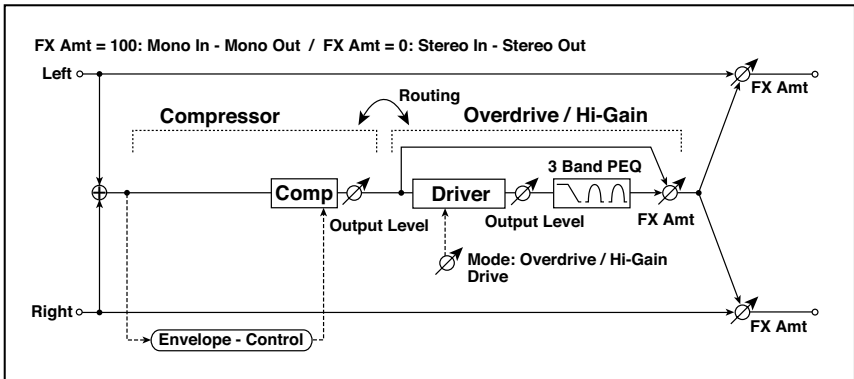

COMPRESSOR

a	[C] Sensitivity	1...100	Sets the sensitivity
b	[C] Attack	1...100	Sets the attack level
	Output Level	0...100	Sets the compressor output level

OD/HI-GAIN

c	[O] Drive Mode	Overdrive, Hi-Gain	Switches between overdrive and high-gain distortion
	Drive	1...100	Sets the degree of distortion
d	[O] Output Level	0...50	Sets the overdrive output level
	Src	Off...Tempo	Selects the modulation source for the overdrive output level
	Amt	-50...+50	Sets the modulation amount of the overdrive output level
e	[O] Low Cutoff [Hz]	20...1.00k	Sets the center frequency for Low EQ (shelving type)
	Gain [dB]	-18...+18	Sets the gain of Low EQ
f	[O] Mid1 Cutoff [Hz]	300...10.00k	Sets the center frequency for Mid/High EQ 1 (peaking type)
	Q	0.5...10.0	Sets the band width of Mid/High EQ 1
	Gain [dB]	-18...+18	Sets the gain of Mid/High EQ 1

g	[O]Mid2 Cutoff [Hz]	500...20.00k	Sets the center frequency for Mid/High EQ 2 (peaking type)
	Q	0.5...10.0	Sets the band width of Mid/High EQ 2
	Gain [dB]	-18...+18	Sets the gain of Mid/High EQ 2
h	[O]Wet/Dry	Dry, 1:99...99:1, Wet	Sets the overdrive effect balance
	Src	Off...Tempo	Selects the Wet/Dry modulation source for the overdrive
	Amt	-100...+100	Sets the Wet/Dry modulation amount for the overdrive
i	Routing	Comp > OD/HG, OD/HG > Comp	Switches the order of the compressor and overdrive
j	Wet/Dry	Dry, 1:99...99:1, Wet	Balance between the wet and dry signal
	Src	Off...Tempo	See the list of DMS (Dynamic Modulation Sources) at the beginning of this part
	Amt	-100...+100	Amount of modulation source

OD / HG + Amp Sim

This effect combines a mono overdrive/high-gain distortion and an amp simulation. You can change the order of the effects.

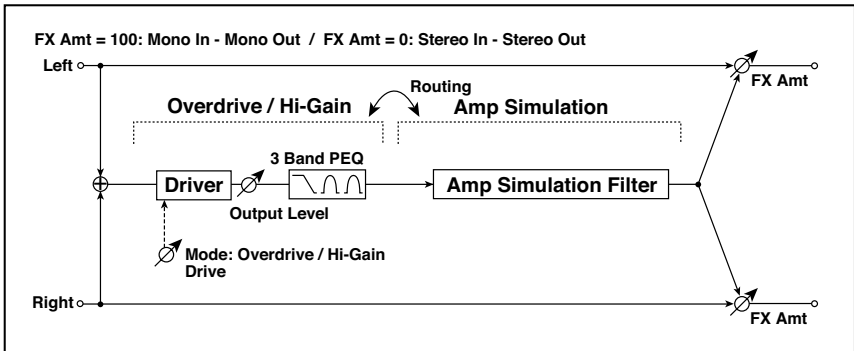

OD/HI-GAIN			
a	[O]Drive Mode	Overdrive, Hi-Gain	Switches between overdrive and high-gain distortion
	Drive	1...100	Sets the degree of distortion
b	[O]Output Level	0...50	Sets the overdrive output level
	Src	Off...Tempo	Selects the modulation source for the overdrive output level
	Amt	-50...+50	Sets the modulation amount of the overdrive output level
c	[O]Low Cutoff [Hz]	20...1.00k	Sets the center frequency for Low EQ (shelving type)
	Gain [dB]	-18...+18	Sets the gain of Low EQ
d	[O]Mid1 Cutoff [Hz]	300...10.00k	Sets the center frequency for Mid/High EQ 1 (peaking type)
	Q	0.5...10.0	Sets the band width of Mid/High EQ 1
	Gain [dB]	-18...+18	Sets the gain of Mid/High EQ 1
e	[O]Mid2 Cutoff [Hz]	500...20.00k	Sets the center frequency for Mid/High EQ 2 (peaking type)
	Q	0.5...10.0	Sets the band width of Mid/High EQ 2
	Gain [dB]	-18...+18	Sets the gain of Mid/High EQ 2
AMP SIM			
f	[A]Amplifier Type	SS, EL84, 6L6	Selects the type of guitar amplifie
g	Routing	OD/HG > Amp, Amp > OD/HG	Switches the order of the overdrive and amp
h	Wet/Dry	Dry, 1:99...99:1, Wet	Balance between the wet and dry signal
	Src	Off...Tempo	See the list of DMS (Dynamic Modulation Sources) at the beginning of this part
	Amt	-100...+100	Amount of modulation source

Wah + Amp Sim

This effect combines a mono wah and an amp simulation. You can change the order of the effects.

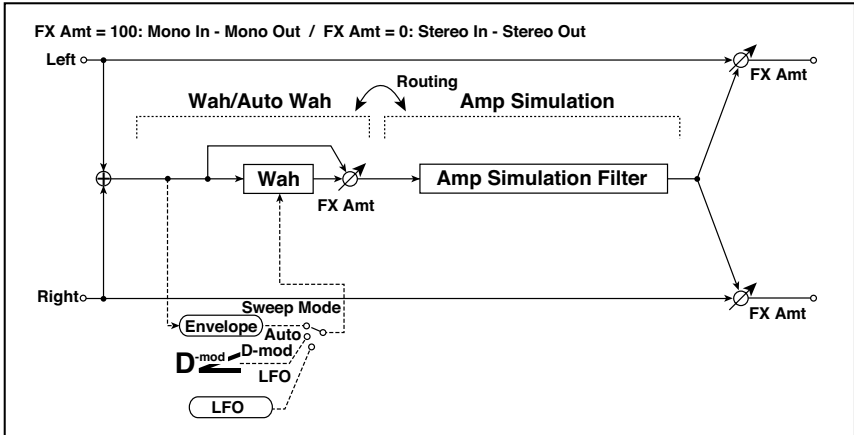

WAH

a	[W]Frequency Bottom	0...100	Sets the lower limit of the wah center frequency
	Frequency Top	0...100	Sets the upper limit of the wah center frequency
b	[W]Sweep Mode	Auto, D-mod, LFO	Selects the control from auto-wah, modulation source, and LFO
	Src	Off...Tempo	Selects the modulation source for the wah when Sweep Mode=D-mod
c	[W]LFO Frequency [Hz]	0.02...20.00	Sets the speed of the LFO
	Resonance	0...100	Sets the resonance amount
	LPF	Off, On	Switches the wah low pass filter on and off
d	[W]Wet/Dry	Dry, 1:99...99:1, Wet	Sets the wah effect balance
	Src	Off...Tempo	Selects the Wet/Dry modulation source for the wah
	Amt	-100...+100	Sets the Wet/Dry modulation amount for the wah

AMP SIM

e	[A]Amplifier Type	SS, EL84, 6L6	Selects the type of guitar amplifier
---	-------------------	---------------	--------------------------------------

f	Routing	Wah > Amp, Amp > Wah	Switches the order of the wah and amp simulation
g	Wet/Dry	Dry, 1:99...99:1, Wet	Balance between the wet and dry signal
	Src	Off...Tempo	See the list of DMS (Dynamic Modulation Sources) at the beginning of this part
	Amt	-100...+100	Amount of modulation source

Decimator + Amp

This effect combines a mono decimator and an amp simulation. You can change the order of the effects.

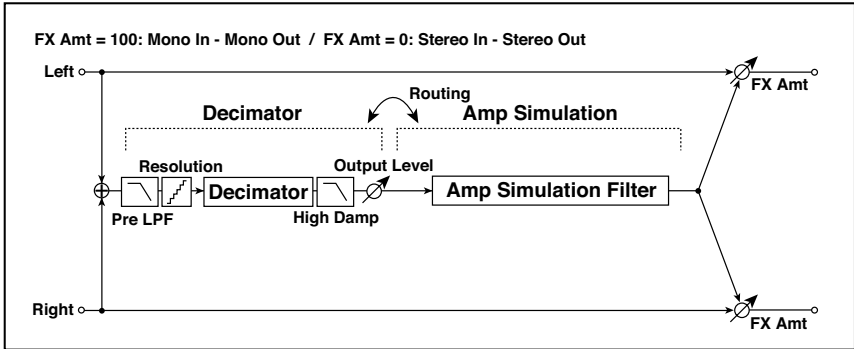

DECIMATOR

a	[D]Pre LPF	Off, On	Turn the harmonic noise caused by lowered sampling on and off
	High Damp [%]	0...100	Sets the ratio of high-range damping
b	[D]Sampling Freq [Hz]	1.00k...48.00k	Sets the sampling frequency
	Resolution	4...24	Sets the data bit length
c	[D]Output Level	0...100	Sets the decimator output level

AMP SIM

d	[A]Amplifier Type	SS, EL84, 6L6	Selects the type of guitar amplifier
e	Routing	Decimator > Amp, Amp > Decimator	Switches the order of the decimator and amp simulation
f	Wet/Dry	Dry, 1:99...99:1, Wet	Balance between the wet and dry signal
	Src	Off...Tempo	See the list of DMS (Dynamic Modulation Sources) at the beginning of this part
	Amt	-100...+100	Amount of modulation source

Amp Sim + Tremolo

This effect combines a mono amp simulation and a tremolo.

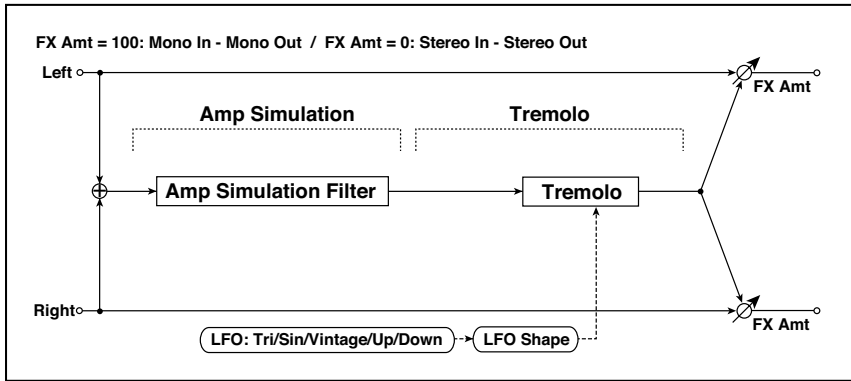

AMP SIM

a [A]Amplifier Type SS, EL84, 6L6 Selects the type of guitar amplifier

TREMOLO

b [T]LFO Waveform Triangle, Sine, Vintage, Up, Down Selects the LFO Waveform

LFO Shape -100...+100 Changes the curvature of the LFO Waveform

c [T]LFO Frequency 0.02...20.00 [Hz] Sets the speed of the LFO

d [T]Depth 0...100 Sets the depth of LFO modulation

e Wet/Dry Dry, 1:99...99:1, Wet Balance between the wet and dry signal

Src Off...Tempo See the list of DMS (Dynamic Modulation Sources) at the beginning of this part

Amt -100...+100 Amount of modulation source

OD / HyperGain + Wah

This distortion effect has two modes: overdrive and hyper-gain that produces a strong distortion. A higher high-gain setting is required for this effect relative to a normal-size effect.

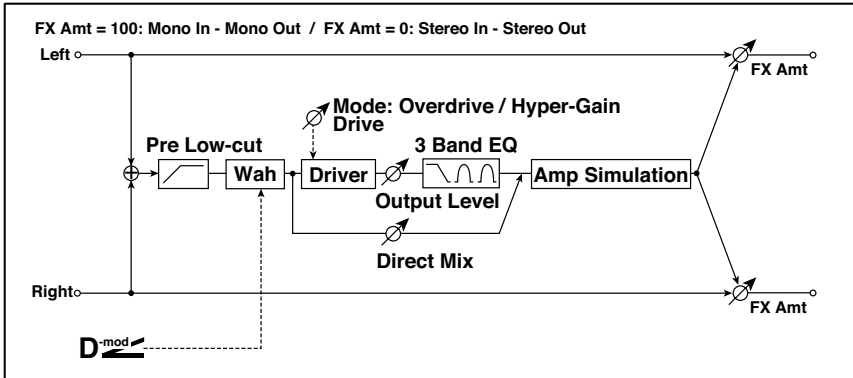

a	Wah	Off, On	Switches Wah on/off
	Src	Off...Tempo	Selects the modulation source that switches the Wah on and off
	Sw	Toggle, Moment	Selects the switching mode for the modulation source that switches the Wah on and off
b	Wah Sweep Range	-10...+10	Sets the range of Wah
	Wah Sweep Src	Off...Tempo	Selects the modulation source that controls the Wah
c	Drive Mode	Overdrive, Hyper-Gain	Switches between overdrive and hi-gain distortion
d	Drive	1...120	Sets the degree of distortion
	Pre Low-cut	0...10	Sets the low range cut amount of the distortion input
e	Output Level	0...50	Sets the output level
	Src	Off...Tempo	Selects the modulation source for the output level
	Amt	-50...+50	Sets the modulation amount of the output level
f	Low Cutoff [Hz]	20...1.00k	Sets the center frequency for Low EQ (shelving type)
	Gain [dB]	-18...+18	Sets the gain of Low EQ

g	Mid1 Cutoff [Hz]	300...10.00k	Sets the center frequency for Mid/High EQ 1 (peaking type)
	Q	0.5...10.0	Sets the band width of Mid/High EQ 1
	Gain [dB]	-18...+18	Sets the gain of Mid/High EQ 1
h	Mid2 Cutoff [Hz]	500...20.00k	Sets the center frequency for Mid/High EQ 2 (peaking type)
	Q	0.5...10.0	Sets the band width of Mid/High EQ 2
	Gain [dB]	-18...+18	Sets the gain of Mid/High EQ 2
i	Direct Mix	0...50	Sets the amount of the dry sound mixed to the distortion
	Speaker Simulation	Off, On	Switches the speaker simulation on/off
j	Wet/Dry	Dry, 1:99...99:1, Wet	Balance between the wet and dry signal
	Src	Off...Tempo	See the list of DMS (Dynamic Modulation Sources) at the beginning of this part
	Amt	-100...+100	Amount of modulation source

Guitar Amp + P4EQ

This combines a guitar amp simulation (which even faithfully replicates the distortion and tone control circuitry) with a four-band equalizer.

By using this in conjunction with St. Guitar Cabinet (Stereo Guitar Cabinet), you can obtain an even more realistic guitar sound that simulates a guitar amp + speaker cabinet.

In alternative, you can use the combined Guitar Amp + Cabinet effect, that does not include an EQ, but only takes a single FX slot.

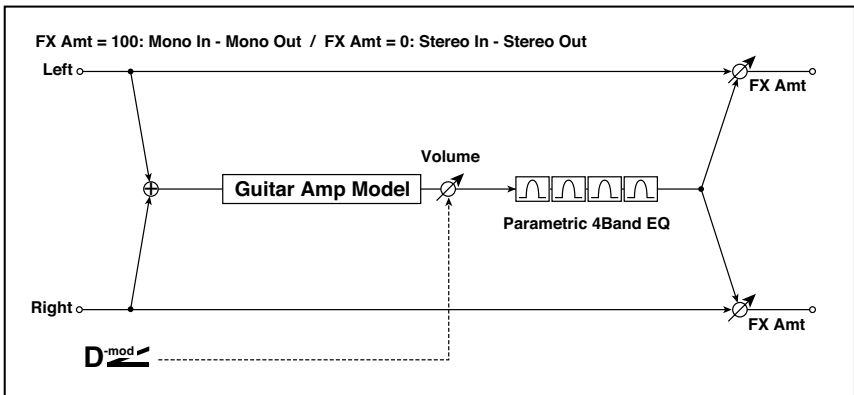

a	Amp Type	VOX AC15, VOX AC15TB, VOX AC30, VOX AC30TB, UK BLUES, UK 70'S, UK 80'S, UK 90'S, UK MODERN, US MODERN, US HIGAIN, BOUTIQUE OD, BOUTIQUE CL, BLACK 2x12, TWEED - 1x12, TWEED - 4x10	Selects the type of the amplifier
	Drive Gain	0...100	Sets the input gain
b	Volume	0...100	Sets the output level
	Src	Off...Tempo	Selects the modulation source for the output level
	Amt	-100...+100	Sets the modulation amount of the output level

c	Bass	0...100	Sets the bass (low range) level
	Middle	0...100	Sets the middle (mid range) level
d	Treble	0...100	Sets the treble (high range) level
	Presence/Cut	0...100	Sets the presence (high-frequency tone). With VOX amps, it simulates the Top Cut on the original AC30; with higher values, it cuts the high frequencies more.
e	Post P4EQ	Thru, On	Selects through or on for the equalizer
f	Band1 Cutoff [Hz]	20...1.00k	Sets the center frequency of Band 1
	Q	0.5...10.0	Sets Band 1's bandwidth
	Gain [dB]	-18...+18	Sets the gain of Band 1
g	Band2 Cutoff [Hz]	50...5.00k	Sets the center frequency of Band 2
	Q	0.5...10.0	Sets Band 2's bandwidth
	Gain [dB]	-18...+18	Sets the gain of Band 2
h	Band3 Cutoff [Hz]	300...10.00k	Sets the center frequency of Band 3
	Q	0.5...10.0	Sets Band 3's bandwidth
	Gain [dB]	-18...+18	Sets the gain of Band 3
i	Band4 Cutoff [Hz]	500...20.00k	Sets the center frequency of Band 4
	Q	0.5...10.0	Sets Band 4's bandwidth
	Gain [dB]	-18...+18	Sets the gain of Band 4
j	Wet/Dry	Dry, 1:99...99:1, Wet	Balance between the wet and dry signal
	Src	Off...Tempo	See the list of DMS (Dynamic Modulation Sources) at the beginning of this part
	Amt	-100...+100	Amount of modulation source

- **a: Amp Type**

- **d: Presence/Cut**

If the Amp Type is VOX AC15...VOX AC30TB, this sets the attenuation of the high-frequency range. For other types, this sets the boost of the high-frequency range. This corresponds to the Cut knob control of amps made by the VOX Corporation.

■ e: Post P4EQ

By chaining this with 19: St.Guitar Cabinet you can simulate the combination of a guitar amp and speaker cabinet. In this case, we recommend that you set Post P4EQ to “Thru,” but if necessary you can turn it “On” and adjust the tone.

Bass Tube Amp + Cab

This simulates a bass amp (with gain and drive) and speaker cabinet.

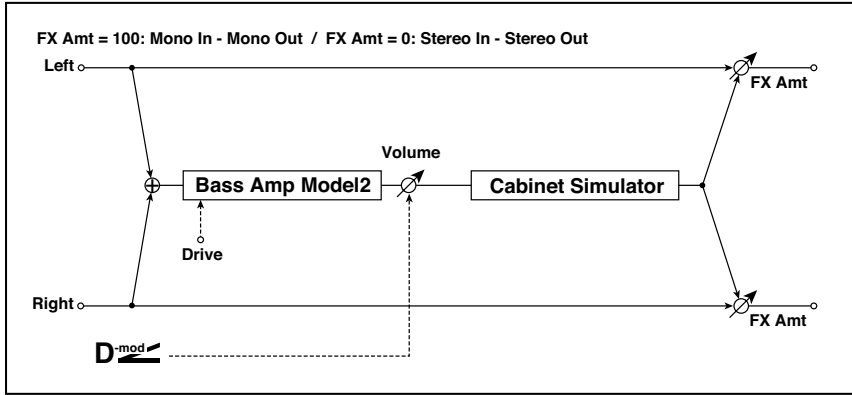

a	Amp Type		Selects the type of the amplifier		
		STUDIO COMBO	A tube combo ideal for the Motown sound		
		VOX AC100	A 100W tube amp AC100 made by Vox		
		UK MAJOR	A 200W tube amp made in the UK		
b	Drive Gain	0...100	Sets the input gain		
		c	Volume	0...100	Sets the output level
				Src	Off...Tempo
	Amt	-100...+100	Sets the modulation amount of the output level		
d	Bass	0...100	Sets the bass (low range) level		
e	Middle	0...100	Sets the middle (mid range) level		
f	Treble	0...100	Sets the treble (high range) level		
g	Presence	0...100	Sets the presence (high-frequency tone)		
h	Cabinet Simulator	Off, On	Switches the cabinet simulator on/off		

i	Cabinet Type	LA - 4x10, MODERN - 4x10, METAL - 4x10, CLASSIC - 8x10, UK - 4x12, STUDIO - 1x15, JAZZ - 1x15, VOX AC100 - 2x15, US - 2x15, UK - 4x15, LA - 1x18, COMBI - 1x12 & 1x18	Selects the cabinet type
j	Wet/Dry	Dry, 1:99...99:1, Wet	Balance between the wet and dry signal
	Src	Off...Tempo	See the list of DMS (Dynamic Modulation Sources) at the beginning of this part
	Amt	-100...+100	Amount of modulation source

■ a: Amp Type

■ i: Cabinet Type

■ Recommended Combinations of Bass Amp Models and Cabinets:

Amp Type	Cabinet Type
STUDIO COMBO	STUDIO - 1x15
AC100	VOX AC100 - 2x15
UK MAJOR	UK - 4x15, UK - 4x12

Stereo Mic + Pre Amp

This is a stereo mic and preamp simulator (Mic Model+PreAmp (Mic Modeling + PreAmp)). For example you might use this to simulate micing of a stereo source such as a rotary speaker.

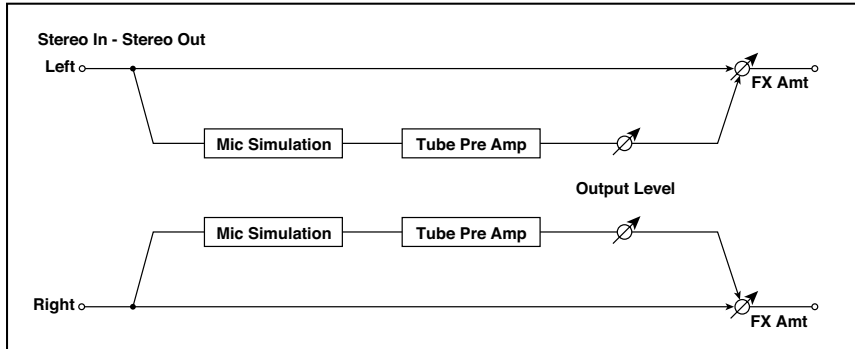

Amp Clean Combo

This models the clean channel of a amp that went on sale in 1975 and contained two 12" speakers. As the name suggests, it produces a clean tone with a tight sounding character, and a deep and compact low-end. When pushed hard the bass tends to crumble. The original amp doesn't have a Presence control but does have a Bright Switch. The Presence control on your Pa4X emulates this switch when Off and On, plus all points in-between.

a	Drive	0...100	Sets the input gain
b	Volume	0...100	Sets the output level
	Src	Off...Tempo	Selects the modulation source for the output level
	Amt	-100...+100	Sets the modulation amount of the output level
c	Bass	0...100	Sets the bass (low range) level
	Middle	0...100	Sets the middle (mid range) level
d	Treble	0...100	Sets the treble (high range) level
	Presence	0...100	Boosts the upper frequencies above the normal treble control range for added high-end
e	Wet/Dry	Dry, 1:99...99:1, Wet	Balance between the wet and dry signal
	Src	Off...Tempo	See the list of DMS (Dynamic Modulation Sources) at the beginning of this part
	Amt	-100...+100	Amount of modulation source

Amp California

This 45W American combo amp with four 10" speakers, produced in South California during the years 1963–1968, was known for its big, clean sound and its warm and husky sound when driven heavily. This amp's medium output and powerful sound was a favorite in clubs.

Original's tube compliment: 4 x 12AX7 in the preamp, 1 x 5AR4 rectifier tube, 2 x 6L6 tubes in the power amp, plus 2 x 12AT7 tubes.

a	Drive	0...100	Sets the input gain
b	Volume	0...100	Sets the output level
	Src	Off...Tempo	Selects the modulation source for the output level
	Amt	-100...+100	Sets the modulation amount of the output level
c	Bass	0...100	Sets the bass (low range) level
	Middle	0...100	Sets the middle (mid range) level
d	Treble	0...100	Sets the treble (high range) level
	Presence	0...100	Sets the presence (high-frequency tone)
e	Wet/Dry	Dry, 1:99...99:1, Wet	Balance between the wet and dry signal
	Src	Off...Tempo	See the list of DMS (Dynamic Modulation Sources) at the beginning of this part
	Amt	-100...+100	Amount of modulation source

Amp Tweed

This 40W American-made tweed-covered 1957 model combo amp with two 12" speakers is known for its rich, clean tone that is ideal for classic rock, blues, and country. By raising the volume you can also produce a powerful and punchy over-drive sound. It quickly became a favorite of the greatest bands of the '60s, and is what you can call 'the classic tone'. Its nickname came from the use of lacquered tweed fronted with vintage brown/gold grille cloth, that gave it that sophisticated look.

Original's tube compliment: 4 x 12AX7 in the preamp, 2 x 5U4 rectifier tube, 2 x 6X4 tubes in the power amp.

a	Drive	0...100	Sets the input gain
b	Volume	0...100	Sets the output level
	Src	Off...Tempo	Selects the modulation source for the output level
	Amt	-100...+100	Sets the modulation amount of the output level
c	Bass	0...100	Sets the bass (low range) level
	Middle	0...100	Sets the middle (mid range) level
d	Treble	0...100	Sets the treble (high range) level
	Presence	0...100	Sets the presence (high-frequency tone)
e	Wet/Dry	Dry, 1:99...99:1, Wet	Balance between the wet and dry signal
	Src	Off...Tempo	See the list of DMS (Dynamic Modulation Sources) at the beginning of this part
	Amt	-100...+100	Amount of modulation source

Amp Modded OD

This models the Overdrive channel of a 100W boutique amp head produced in North Hollywood. Its beautifully deep and rounded low-end, delightfully transient midrange attack and sweet treble, with an harmonically rich overdrive, the lush-est clean tone, woody attack and blooming sustain, make it an instant pleasure to play.

Original's tube compliment: 2 x 12AX7s in the preamp, 1 x 12AX7s rectifier, 4 x EL34s (or 6L6s) in the power amp.

a	Drive	0..100	Sets the input gain
b	Volume	0...100	Sets the output level
	Src	Off...Tempo	Selects the modulation source for the output level
	Amt	-100...+100	Sets the modulation amount of the output level
c	Bass	0..100	Sets the bass (low range) level
	Middle	0...100	Sets the middle (mid range) level
d	Treble	0..100	Sets the treble (high range) level
	Presence	0...100	Sets the presence (high-frequency tone)
e	Wet/Dry	Dry, 1:99...99:1, Wet	Balance between the wet and dry signal
	Src	Off...Tempo	See the list of DMS (Dynamic Modulation Sources) at the beginning of this part
	Amt	-100...+100	Amount of modulation source

Guitar Cab + NR

Guitar cabinet and Noise Reduction.

	NR Sens	Off, 1...100	Noise Reduction sensitivity
a	Trim	0...100	Sets the input level
b	Type	TWEED - 1x12, TWEED - 4x10, BLACK - 2x10, BLACK - 2x12, VOX AC15 - 1x12, VOX AC30 - 2x12, VOX AD412 - 4x12, UK H30 - 4x12, UK T75 - 4x12, US V30 - 4x12	Selects the cabinet type
c	Air	0...100	Sets the mic position
d	Wet/Dry	Dry, 1:99...99:1, Wet	Balance between the wet and dry signal
	Src	Off...Tempo	See the list of DMS (Dynamic Modulation Sources) at the beginning of this part
	Amt	-100...+100	Amount of modulation source

Guitar Amp + Cab

As the **Guitar Amp** effect, minus the EQ, plus the cabinet.

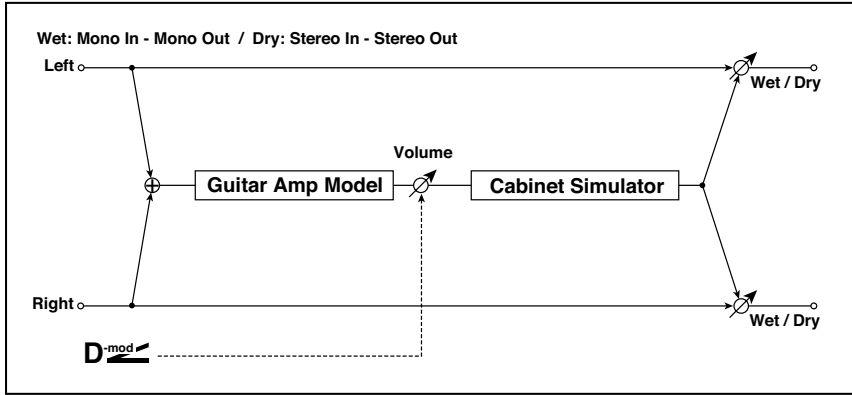

a	Amp Type	VOX AC15, VOX AC15TB, VOX AC30, VOX AC30TB, UK BLUES, UK 70'S, UK 80'S, UK 90'S, UK MODERN, US MODERN, US HIGAIN, BOUTIQUE OD, BOUTIQUE CL, BLACK 2x12, TWEED - 1x12, TWEED - 4x10	Selects the type of the amplifier
b	Drive Gain	0...100	Sets the input gain
c	Volume	0...100	Sets the output level
	Src	Off...Tempo	Selects the modulation source for the output level
	Amt	-100...+100	Sets the modulation amount of the output level
d	Bass	0...100	Sets the bass (low range) level
	Middle	0...100	Sets the middle (mid range) level
	Treble	0...100	Sets the treble (high range) level
	Presence/Cut	0...100	Sets the presence (high-frequency tone). With VOX amps, it simulates the Top Cut on the original AC30; with higher values, it cuts the high frequencies more.

e	Cabinet Type	TWEED - 1x12, TWEED - 4x10, BLACK - 2x10, BLACK - 2x12, VOX AC15 - 1x12, VOX AC30 - 2x12, VOX AD412 - 4x12, UK H30 - 4x12, UK T75 - 4x12, US V30 - 4x12	Selects the cabinet type
	Cabinet Trim	0...100	Sets the input level
	Cabinet Air	0...100	Sets the mic position
f	Noise Gate On/Off	On, Off	Switches Gate on/off
	Threshold	0...100	Sets the level at which gating is applied
	Attack	1...100	Sets the attack time
	Release	1...100	Sets the release time
g	Wet/Dry	Dry, 1:99...99:1, Wet	Balance between the wet and dry signal
	Src	Off...Tempo	See the list of DMS (Dynamic Modulation Sources) at the beginning of this part
	Amt	-100...+100	Amount of modulation source

Amp Clean Combo + Cab

As the **Amp Clean Combo** effect, plus cabinet.

a	Drive	0...100	Sets the input gain
b	Volume	0...100	Sets the output level
	Src	Off...Tempo	Selects the modulation source for the output level
	Amt	-100...+100	Sets the modulation amount of the output level
c	Bass	0...100	Sets the bass (low range) level
	Middle	0...100	Sets the middle (mid range) level
d	Treble	0...100	Sets the treble (high range) level
	Presence	0...100	Sets the presence (high-frequency tone)
e	Cabinet Type	TWEED - 1x12, TWEED - 4x10, BLACK - 2x10, BLACK - 2x12, VOX AC15 - 1x12, VOX AC30 - 2x12, VOX AD412 - 4x12, UK H30 - 4x12, UK T75 - 4x12, US V30 - 4x12	Selects the cabinet type
f	Cabinet Trim	0...100	Sets the input level
g	Cabinet Air	0...100	Sets the mic position
h	Noise Gate On/Off	On, Off	Switches Gate on/off
	Threshold	0...100	Sets the level at which gating is applied
	Attack	1...100	Sets the attack time
	Release	1...100	Sets the release time
i	Wet/Dry	Dry, 1:99...99:1, Wet	Balance between the wet and dry signal
	Src	Off...Tempo	See the list of DMS (Dynamic Modulation Sources) at the beginning of this part
	Amt	-100...+100	Amount of modulation source

Amp California + Cab

As the **Amp California** effect, plus the cabinet.

a	Drive	0...100	Sets the input gain
b	Volume	0...100	Sets the output level
	Src	Off...Tempo	Selects the modulation source for the output level
	Amt	-100...+100	Sets the modulation amount of the output level
c	Bass	0...100	Sets the bass (low range) level
	Middle	0...100	Sets the middle (mid range) level
d	Treble	0...100	Sets the treble (high range) level
	Presence	0...100	Sets the presence (high-frequency tone)
e	Cabinet Type	TWEED - 1x12, TWEED - 4x10, BLACK - 2x10, BLACK - 2x12, VOX AC15 - 1x12, VOX AC30 - 2x12, VOX AD412 - 4x12, UK H30 - 4x12, UK T75 - 4x12, US V30 - 4x12	Selects the cabinet type
f	Cabinet Trim	0...100	Sets the input level
g	Cabinet Air	0...100	Sets the mic position
h	Noise Gate On/Off	On, Off	Switches Gate on/off
	Threshold	0...100	Sets the level at which gating is applied
	Attack	1...100	Sets the attack time
	Release	1...100	Sets the release time
i	Wet/Dry	Dry, 1:99...99:1, Wet	Balance between the wet and dry signal
	Src	Off...Tempo	See the list of DMS (Dynamic Modulation Sources) at the beginning of this part
	Amt	-100...+100	Amount of modulation source

Amp Tweed + Cab

As the **Amp Tweed** effect, plus the cabinet.

a	Drive	0...100	Sets the input gain
b	Volume	0...100	Sets the output level
	Src	Off...Tempo	Selects the modulation source for the output level
	Amt	-100...+100	Sets the modulation amount of the output level
c	Bass	0...100	Sets the bass (low range) level
	Middle	0...100	Sets the middle (mid range) level
d	Treble	0...100	Sets the treble (high range) level
	Presence	0...100	Sets the presence (high-frequency tone)
e	Cabinet Type	TWEED - 1x12, TWEED - 4x10, BLACK - 2x10, BLACK - 2x12, VOX AC15 - 1x12, VOX AC30 - 2x12, VOX AD412 - 4x12, UK H30 - 4x12, UK T75 - 4x12, US V30 - 4x12	Selects the cabinet type
f	Cabinet Trim	0...100	Sets the input level
g	Cabinet Air	0...100	Sets the mic position
h	Noise Gate On/Off	On, Off	Switches Gate on/off
	Threshold	0...100	Sets the level at which gating is applied
	Attack	1...100	Sets the attack time
	Release	1...100	Sets the release time
i	Wet/Dry	Dry, 1:99...99:1, Wet	Balance between the wet and dry signal
	Src	Off...Tempo	See the list of DMS (Dynamic Modulation Sources) at the beginning of this part
	Amt	-100...+100	Amount of modulation source

Amp Modded OD + Cab

As the **Amp Modded OD** effect, plus the cabinet.

a	Drive	0...100	Sets the input gain
b	Volume	0...100	Sets the output level
	Src	Off...Tempo	Selects the modulation source for the output level
	Amt	-100...+100	Sets the modulation amount of the output level
c	Bass	0...100	Sets the bass (low range) level
	Middle	0...100	Sets the middle (mid range) level
d	Treble	0...100	Sets the treble (high range) level
	Presence	0...100	Sets the presence (high-frequency tone)
e	Cabinet Type	TWEED - 1x12, TWEED - 4x10, BLACK - 2x10, BLACK - 2x12, VOX AC15 - 1x12, VOX AC30 - 2x12, VOX AD412 - 4x12, UK H30 - 4x12, UK T75 - 4x12, US V30 - 4x12	Selects the cabinet type
f	Cabinet Trim	0...100	Sets the input level
g	Cabinet Air	0...100	Sets the mic position
h	Noise Gate On/Off	On, Off	Switches Gate on/off
	Threshold	0...100	Sets the level at which gating is applied
	Attack	1...100	Sets the attack time
	Release	1...100	Sets the release time
i	Wet/Dry	Dry, 1:99...99:1, Wet	Balance between the wet and dry signal
	Src	Off...Tempo	See the list of DMS (Dynamic Modulation Sources) at the beginning of this part
	Amt	-100...+100	Amount of modulation source

CX-3 Amp

This is a detailed model of the amp of a classic tonewheel organ. With the addition of the 3band EQ, this amp simulation will allow you to create a very versatile distortion. This amp model is especially suitable for organ sounds.

You can select one of two amp models, or a direct line out from the organ's pre-amp. Type 1 is a standard powered amp for organ, producing a warm, fat tone. Type 2 yields a less colored tone, with more high frequencies than Type 1. Preamp is the sound of a direct line out from the organ, without the amp gain (but with all the other controls).

AMP			
a	Type	Amp Type 1, 2, Preamp	Type of amp model. Pre Amp bypasses the amp gain.
	Gain	0...100	Sets the gain when Type is set to Type 1 or Type 2. It does not apply if the Amp Type is set to Pre Amp. You can use an Expression pedal to control the amount of overdrive and distortion. With higher Gain values, you can reach heavy distortion; with Gain = 0, the amp will always remain clean.
	Src	Off...Tempo	Selects the modulation source for the gain level
	Amt	-100...+100	Amount of modulation source
EQ			
b	Bass	-10...+10	Adjusts the bass frequencies.
	Middle	-10...+10	Adjusts the middle frequencies.
	Treble	-10...+10	Adjusts the high frequencies.
OUTPUT			
c	Level	0...100	Sets the output level
	Src	Off...Tempo	Selects the modulation source for the output level
	Amt	-100...+100	Amount of modulation source
EXPRESSION			
d	Minimum	0...100	Minimum allowed value
	Expression	0...100	Starting value
	Src	Off...Tempo	Selects the modulation source for the Expression level
	Expression Mode	Add	The Expression pedal will working together with the set Expression parameter

Multiple	The Expression pedal action will work together with the set Expression parameter; the Expression parameter will set the maximum level
Overwrite	The Expression pedal will control the Expression level

Delay

L/C/R Delay

This multitap delay outputs three Tap signals to the left, right, and center respectively. You can also adjust the left and right spread of the delay sound.

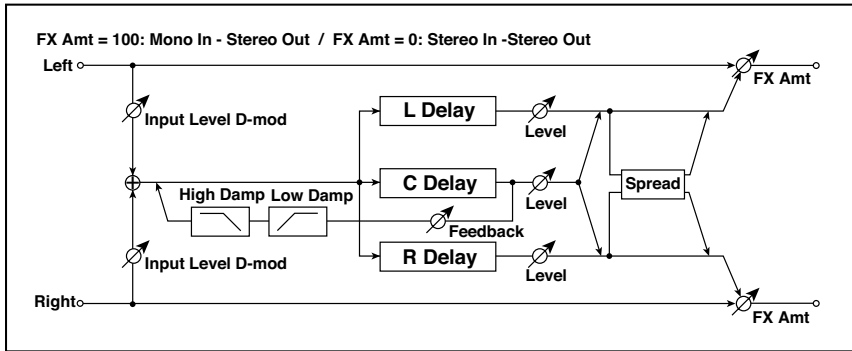

a	L Delay Time [msec]	0...2730	Sets the delay time of TapL
	Level	0...50	Sets the output level of TapL
b	C Delay Time [msec]	0...2730	Sets the delay time of TapC
	Level	0...50	Sets the output level of TapC
c	R Delay Time [msec]	0...2730	Sets the delay time of TapR
	Level	0...50	Sets the output level of TapR
d	Feedback (C Delay)	-100...+100	Sets the feedback amount of TapC
	Src	Off...Tempo	Selects the modulation source of the TapC feedback amount
	Amt	-100...+100	Sets the modulation amount of the TapC feedback amount
e	High Damp [%]	0...100	Sets the damping amount in the high range
	Low Damp [%]	0...100	Sets the damping amount in the low range
f	Input Level Dmod [%]	-100...+100	Sets the modulation amount of the input level
	Src	Off...Tempo	Selects the modulation source for the input level

g	Spread	0...50	Sets the width of the stereo image of the effect sound
h	Wet/Dry	Dry, 1:99...99:1, Wet	Balance between the wet and dry signal
	Src	Off...Tempo	See the list of DMS (Dynamic Modulation Sources) at the beginning of this part
	Amt	-100...+100	Amount of modulation source

■ e: High Damp [%]

■ e: Low Damp [%]

These parameters set the damping amount of high range and low range. The tone of the delayed sound becomes darker and lighter as it feeds back.

■ g: Spread

This parameter sets the pan width of the effect sound. The stereo image is widest with a value of 50, and the effect sound of both channels is output from the center with a value of 0.

Stereo/Cross Delay

This is a stereo delay, and can be used as a cross-feedback delay effect in which the delay sounds cross over between the left and right by changing the feedback routing.

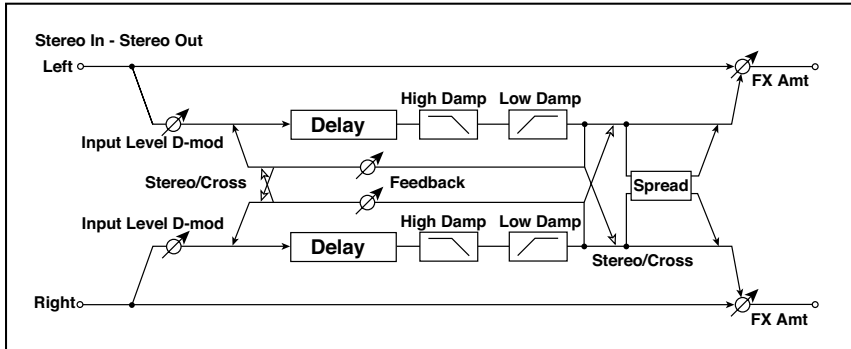

a	Stereo/Cross	Stereo, Cross	Switches between stereo delay and cross-feedback delay
b	L Delay Time [msec]	0.0...1360.0	Sets the delay time for the left channel
c	R Delay Time [msec]	0.0...1360.0	Sets the delay time for the right channel
d	L Feedback	-100...+100	Sets the feedback amount for the left channel
	Src	Off...Tempo	Selects the modulation source of feedback amount
	Amt L	-100...+100	Sets the modulation amount of the left channel feedback
e	R Feedback	-100...+100	Sets the feedback amount for the right channel
	Amt R	-100...+100	Sets the modulation amount of the right channel feedback
f	High Damp [%]	0...100	Sets the damping amount in the high range
g	Low Damp [%]	0...100	Sets the damping amount in the low range
h	Input Level Dmod [%]	-100...+100	Sets the modulation amount of the input level
	Src	Off...Tempo	Selects the modulation source for the input level
i	Spread	-50...+50	Sets the width of the stereo image of the effect sound

j	Wet/Dry	Dry, 1:99...99:1, Wet	Balance between the wet and dry signal
	Src	Off...Tempo	See the list of DMS (Dynamic Modulation Sources) at the beginning of this part
	Amt	-100...+100	Amount of modulation source

Stereo Multitap Delay

The left and right Multitap Delays have two taps respectively. Changing the routing of feedback and tap output allows you to create various patterns of complex effect sounds.

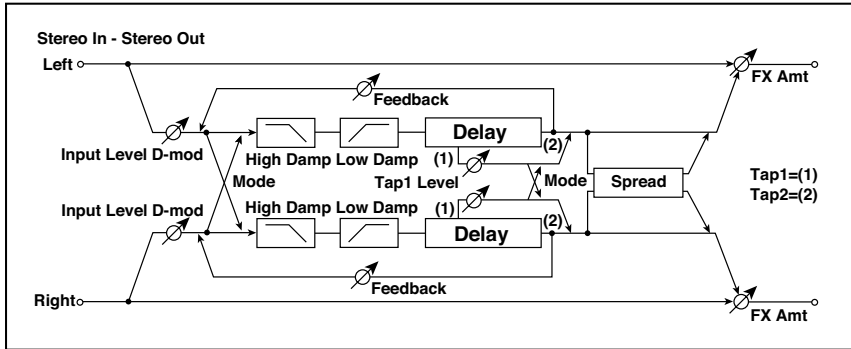

a	Mode	Normal, Cross Feedback, Cross Pan1, Cross Pan2	Switches the left and right delay routing
b	Tap1 Time [msec]	0.0...1360.0	Sets the Tap1 delay time
c	Tap2 Time [msec]	0.0...1360.0	Sets the Tap2 delay time
d	Tap1 Level	0...100	Sets the Tap1 output level
e	Feedback (Tap2)	-100...+100	Sets the Tap2 feedback amount
	Src	Off...Tempo	Selects the modulation source of the Tap2 feedback amount
	Amt	-100...+100	Sets the modulation amount of the Tap2 feedback amount
f	High Damp [%]	0...100	Sets the damping amount in the high range
g	Low Damp [%]	0...100	Sets the damping amount in the low range
h	Input Level Dmod [%]	-100...+100	Sets the modulation amount of the input level
	Src	Off...Tempo	Selects the modulation source for the input level
i	Spread	-100...+100	Sets the width of the stereo image of the effect sound
	Src	Off...Tempo	Selects the modulation source of the effect sound's stereo image width
	Amt	-100...+100	Sets the modulation amount of the effect sound's stereo image width

j	Wet/Dry	Dry, 1:99...99:1, Wet	Balance between the wet and dry signal
	Src	Off...Tempo	See the list of DMS (Dynamic Modulation Sources) at the beginning of this part
	Amt	-100...+100	Amount of modulation source

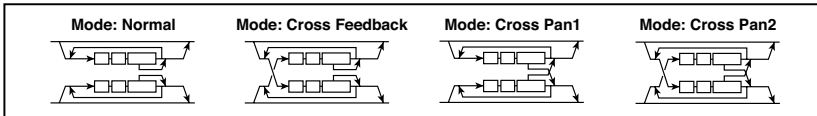

■ a: Mode

You can change how the left and right delay signals are panned by modifying the routing of the left and right delay as shown in the figure above. You need to input different sounds to each channel in order for this parameter to be effective.

■ d: Tap1 Level

This parameter sets the output level of Tap1. Setting a different level from Tap2 will add a unique touch to a monotonous delay and feedback.

Stereo Mod Delay

This stereo delay uses an LFO to sweep the delay time. The pitch also varies, creating a delay sound which swells and shimmers. You can also control the delay time using a modulation source.

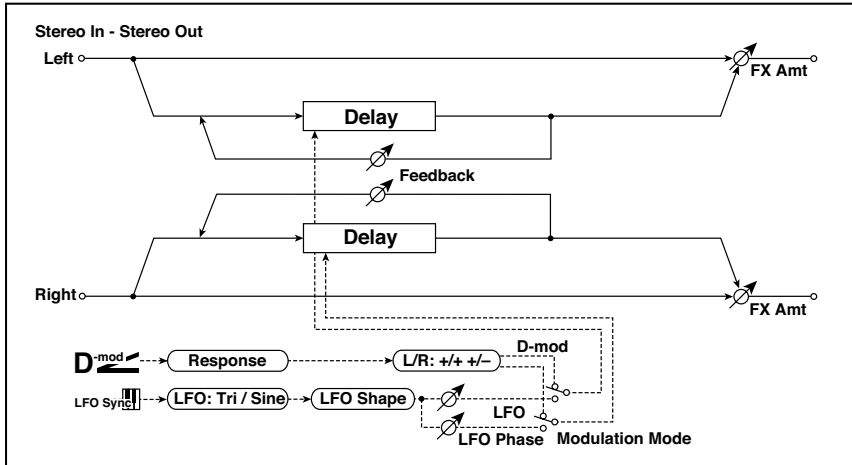

a	Modulation Mode	LFO, D-mod	Switches between LFO modulation control and modulation source control
b	D-mod Modulation	L/R: +/+, L/R: +/-	Reversed L/R control by modulation source
	Src	Off...Tempo	Selects the modulation source that controls delay time
	Response	0...30	Sets the rate of response to the modulation source
c	LFO Waveform	Triangle, Sine	Selects the LFO Waveform
	LFO Shape	-100...+100	Changes the curvature of the LFO Waveform
d	LFO Sync	Off, On	Switches LFO reset off/on
	Src	Off...Tempo	Selects the modulation source that resets the LFO
e	LFO Frequency [Hz]	0.02...20.00	Sets the speed of the LFO

f	MIDI Sync	Off, On	When this is on, the LFO speed is set by BPM, Base Note, and Times, instead of Frequency
	BPM	MIDI, 40.00... 300.00	MIDI syncs to the system tempo; 40–300 sets the tempo manually for this individual effect
	Base Note		Selects the type of notes that specify the LFO speed
	Times	x1...x32	Sets the number of notes that specify the LFO speed
g	L LFO Phase [deg]	-180...+180	Sets the phase obtained when the left LFO is reset
	L Depth	0...200	Sets the depth of the left LFO modulation
h	R LFO Phase [deg]	-180...+180	Sets the phase obtained when the right LFO is reset
	R Depth	0...200	Sets the depth of the right LFO modulation
i	L Delay Time [msec]	0.0...1000.0	Sets the delay time for the left channel
	L Feedback	-100...+100	Sets the feedback amount of left delay
j	R Delay Time [msec]	0.0...1000.0	Sets the delay time for the right channel
	R Feedback	-100...+100	Sets the feedback amount of right delay
k	Wet/Dry	-Wet, -1:99... Dry...99:1, Wet	Balance between the wet and dry signal
	Src	Off...Tempo	See the list of DMS (Dynamic Modulation Sources) at the beginning of this part
	Amt	-100...+100	Amount of modulation source

■ b: D-mod Modulation

When the modulation source is used for control, this parameter reverses the left and right modulation direction.

■ d: LFO Sync

■ d: Src

■ g: L LFO Phase [deg]

■ h: R LFO Phase [deg]

If “LFO Sync” is On, the LFO will be reset by the modulation source that is received.

The “Src” parameter sets the modulation source that resets the LFO. For example, you can assign Gate as a modulation source so that the sweep always starts from the specified point.

“L LFO Phase” and “R LFO Phase” set the phase obtained when the left and right LFOs are reset. In this way, you can create changes in pitch sweep for the left and right channels individually.

MIDI The effect is off when a value of the modulation source specified in the “Src” parameter is 63 or smaller, and the effect is on when the value is 64 or higher. The LFO is triggered and reset to the “L LFO Phase” and “R LFO Phase” settings when the value changes from 63 or smaller to 64 or higher.

Stereo Dynamic Delay

This stereo delay controls the level of delay according to the input signal level. You can use this as a ducking delay that applies delay to the sound only when you play keys at a high velocity or only when the volume level is low.

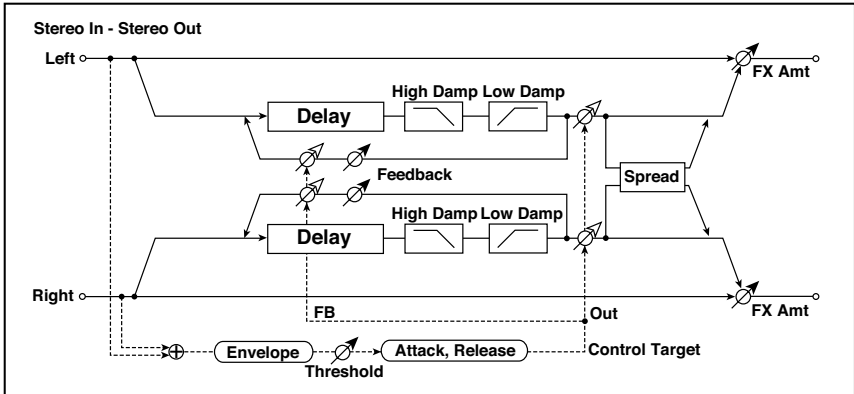

a	Control Target	None, Out, FB	Selects from no control, output, and feedback
	Polarity	+, -	Reverses level control
b	Threshold	0...100	Sets the level to which the effect is applied
	Offset	0...100	Sets the offset of level control
c	Attack	1...100	Sets the attack time of level control
d	Release	1...100	Sets the release time of level control
e	L Delay Time [msec]	0.0...1360.0	Sets the delay time for the left channel
f	R Delay Time [msec]	0.0...1360.0	Sets the delay time for the right channel
g	Feedback	-100...+100	Sets the feedback amount
h	High Damp [%]	0...100	Sets the damping amount in the high range
	Low Damp [%]	0...100	Sets the damping amount in the low range
i	Spread	-100...+100	Sets the width of the stereo image of the effect sound
j	Wet/Dry	Dry, 1:99...99:1, Wet	Balance between the wet and dry signal
	Src	Off...Tempo	See the list of DMS (Dynamic Modulation Sources) at the beginning of this part
	Amt	-100...+100	Amount of modulation source

■ **a: Control Target**

This parameter selects no level control, delay output control (effect balance), or feedback amount control.

■ **a: Polarity**

■ **b: Threshold**

■ **b: Offset**

■ **c: Attack**

■ **d: Release**

The “Offset” parameter specifies the value for the “Control Target” parameter (that is set to None), expressed as the ratio relative to the parameter value (the “Wet/Dry” value with “Control Target”=Output level, or the “Feedback” value with “Control Target”=Feedback).

When “Polarity” is positive, the “Control Target” value is obtained by multiplying the parameter value by the “Offset” value (if the input level is below the threshold), or equals the parameter value if the input level exceeds the threshold.

When “Polarity” is negative, Control Target value equals the parameter value if the input level is below the threshold, or is obtained by multiplying the parameter value by the “Offset” value if the level exceeds the threshold.

The “Attack” and “Release” parameters specify attack time and release time of delay level control.

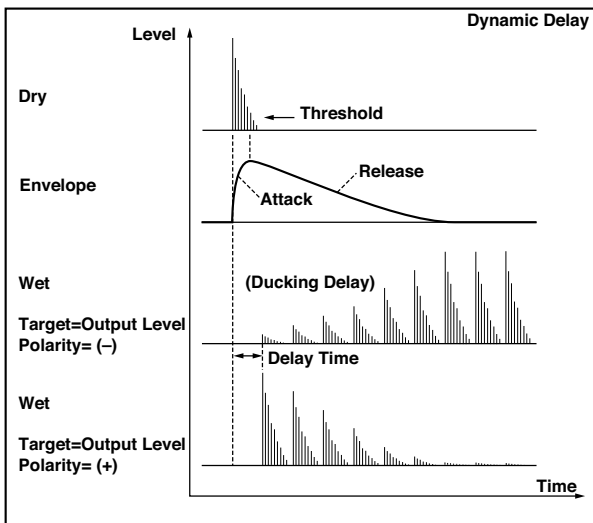

Stereo AutoPan Delay

This stereo delay effect pans the delay sound left and right using the LFO.

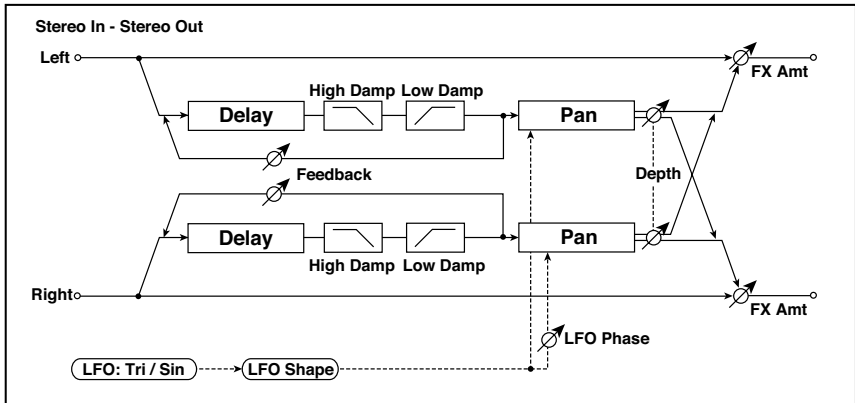

a	L Delay Time [msec]	0.0...1360.0	Sets the delay time for the left channel
	L Feedback	-100...+100	Sets the feedback amount for the left channel
b	R Delay Time [msec]	0.0...1360.0	Sets the delay time for the right channel
	R Feedback	-100...+100	Sets the feedback amount for the right channel
c	High Damp [%]	0...100	Sets the damping amount in the high range
	Low Damp [%]	0...100	Sets the damping amount in the low range
d	LFO Waveform	Triangle, Sine	Selects the LFO Waveform
	LFO Shape	-100...+100	Changes the curvature of the LFO Waveform
e	Phase [degree]	-180...+180	Sets the LFO phase difference between the left and right
f	Panning Freq [Hz]	0.02...20.00	Sets the panning speed
g	MIDI Sync	Off, On	Switches between using the frequency of the panning speed and using the tempo and notes
	BPM	MIDI, 40.00... 300.00	MIDI syncs to the system tempo; 40-300 sets the tempo manually for this individual effect
	Base Note		Selects the type of notes to specify the delay time for the panning speed
	Times	x1...x32	Sets the number of notes to specify the delay time for the panning speed

h	Panning Depth	0...100	Sets the panning width
	Src	Off...Tempo	Selects the modulation source for the panning width
	Amt	-100...+100	Set the modulation amount of the panning width
i	Wet/Dry	Dry, 1:99...99:1, Wet	Balance between the wet and dry signal
	Src	Off...Tempo	See the list of DMS (Dynamic Modulation Sources) at the beginning of this part
	Amt	-100...+100	Amount of modulation source

Tape Echo

This effect simulates a tape echo unit with three playback heads. The distortion and tonal change typical of magnetic tape are also reproduced.

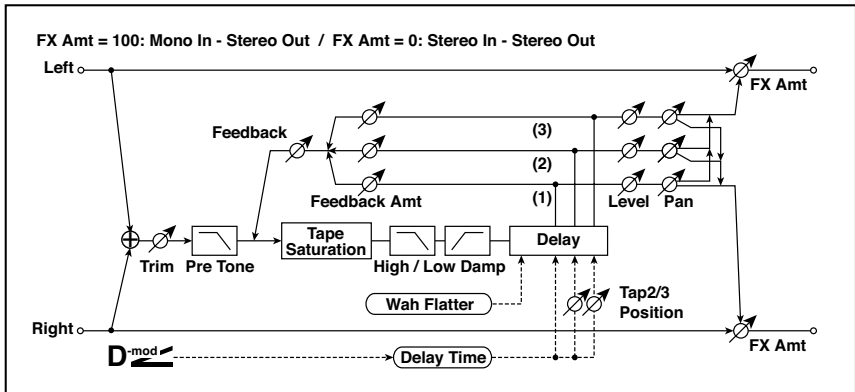

a	Delay (Tap1) [msec]	0...2700	Sets the delay time (tap1)
	Src	Off...Tempo	Selects the modulation source of the delay time
	Amt	-2700... +2700	Sets the modulation amount of delay time
b	Tap2 Position [%]	0...100	Sets the position of Tap 2 relative to the Tap 1 delay time the depth of pitch variation
c	Tap3 Position [%]	0...100	Sets the position of Tap 3 relative to the Tap 1 delay time the depth of pitch variation
d	Tap1 Level	0...100	Sets the Tap1 output level
	Pan	L, 1...99, R	Sets the stereo image of tap1
	FB Amt	-100...+100	Sets the Tap1 feedback amount
e	Tap2 Level	0...100	Sets the Tap2 output level
	Pan	L, 1...99, R	Sets the stereo image of tap2
	FB Amt	-100...+100	Sets the Tap2 feedback amount
f	Tap3 Level	0...100	Sets the Tap3 output level
	Pan	L, 1...99, R	Sets the stereo image of tap3
	FB Amt	-100...+100	Sets the Tap3 feedback amount
g	Feedback	0...100	Sets the amount of feedback for Taps 1, 2, and 3
	Src	Off...Tempo	Selects the modulation source of feedback amount
	Amt	-100...+100	Sets the feedback amount

h	High Damp [%]	0...100	Sets the damping amount in the high range
	Low Damp [%]	0...100	Sets the damping amount in the low range
i	Saturation	0...100	Sets the distortion amount
j	Input Trim	0...100	Sets the input gain
	Pre Tone	0...100	Sets the tone of the input
k	Wow Flutter [Hz]	0.02...1.00	Sets the frequency at which pitch variation will occur
	Wow Flutter depth	0...100	Sets the depth of pitch variation
l	Wet/Dry	Dry, 1:99...99:1, Wet	Balance between the wet and dry signal
	Src	Off...Tempo	See the list of DMS (Dynamic Modulation Sources) at the beginning of this part
	Amt	-100...+100	Amount of modulation source

- **a: Delay (Tap1) [msec]**

- **a: Src**

- **a: Amt**

- **b: Tap2 Position [%]**

- **b: Tap3 Position [%]**

The delay time for Tap 2 and 3 is specified as a proportion (%) relative to “Delay (Tap1).” Even if you use dynamic modulation to control “Delay (Tap1),” Tap 2 and 3 will change at the same proportion.

- **d: FB Amt**

- **e: FB Amt**

- **f: FB Amt**

- **g: Feedback**

The feedback output from Tap 1, 2, and 3 is mixed according to the “FB Amt,” and then the final amount of feedback is specified by “Feedback.”

Sequence BPM Delay

This four-tap delay enables you to select a tempo and rhythm pattern to set up each tap.

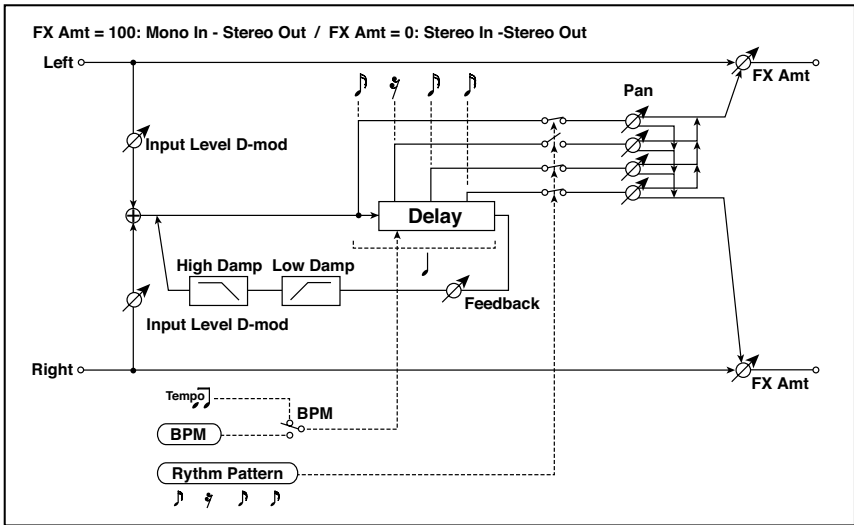

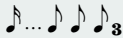
a	BPM	MIDI, 40.00... 300.00	MIDI syncs to the system tempo; 40–300 sets the tempo manually for this individual effect
b	Rhythm Pattern		Selects a rhythm pattern
c	Tap1 Pan	L, 1...99, R	Sets the panning of Tap1
	Tap2 Pan	L, 1...99, R	Sets the panning of Tap2
	Tap3 Pan	L, 1...99, R	Sets the panning of Tap3
	Tap4 Pan	L, 1...99, R	Sets the panning of Tap4
d	Feedback	-100...+100	Sets the feedback amount
	Src	Off...Tempo	Selects the modulation source of feedback amount
	Amt	-100...+100	Sets the feedback amount
e	High Damp [%]	0...100	Sets the damping amount in the high range
	Low Damp [%]	0...100	Sets the damping amount in the low range
f	Input Level Dmod [%]	-100...+100	Sets the modulation amount of the input level
	Src	Off...Tempo	Selects the modulation source for the input level

g	Wet/Dry	Dry, 1:99...99:1, Wet	Balance between the wet and dry signal
	Src	Off...Tempo	See the list of DMS (Dynamic Modulation Sources) at the beginning of this part
	Amt	-100...+100	Amount of modulation source

- **a: BPM**



- **b: Rhythm Pattern**

With the tempo specified by the “BPM” parameter (or the MIDI Clock tempo if “BPM” is set to MIDI), the length of one beat equals the feedback delay time, and the interval between taps becomes equal. Selecting a rhythm pattern will automatically turn the tap outputs on and off. When “BPM” is set to MIDI, the lower limit of the “BPM” is 44.

L/C/R BPM Delay

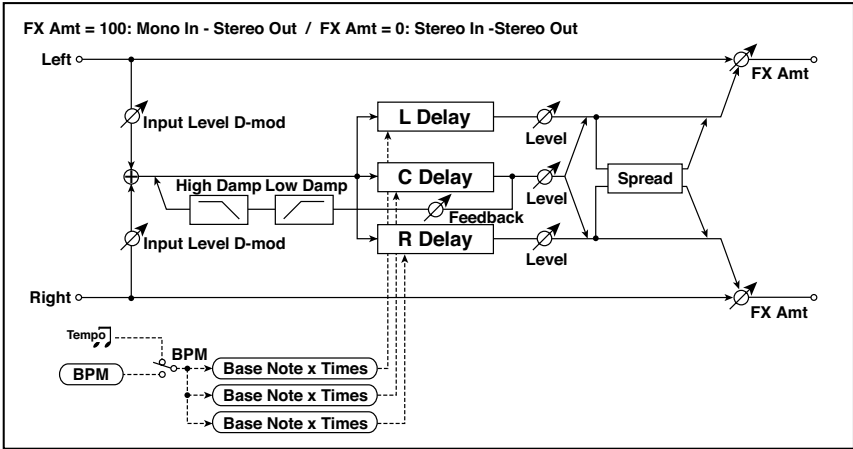
The L/C/R delay enables you to match the delay time with the song tempo. You can also synchronize the delay time with the arpeggiator or sequencer. If you program the tempo before performance, you can achieve a delay effect that synchronizes with the song in real-time. Delay time is set by notes.



a	BPM	MIDI, 40.00... 300.00	MIDI syncs to the system tempo; 40–300 sets the tempo manually for this individual effect
	Time Over?	---, OVER!	Displays an error message when the delay time exceeds the upper limit
b	L Delay Base Note		Selects the type of notes to specify the delay time for TapL
	Times	x1...x32	Sets the number of notes to specify the delay time for TapL
	Level	0...50	Sets the output level of TapL
c	C Delay Base Note		Selects the type of notes to specify the delay time for TapC
	Times	x1...x32	Sets the number of notes to specify the delay time for TapC
	Level	0...50	Sets the output level of TapC
d	R Delay Base Note		Selects the type of notes to specify the delay time for TapR
	Times	x1...x32	Sets the number of notes to specify the delay time for TapR
	Level	0...50	Sets the output level of TapR
e	Feedback (C Delay)	-100...+100	Sets the feedback amount of TapC
	Src	Off... Tempo	Selects the modulation source for the TapC feedback
	Amt	-100...+100	Sets the modulation amount of the TapC feedback
f	High Damp [%]	0...100	Sets the damping amount in the high range
	Low Damp [%]	0...100	Sets the damping amount in the low range
g	Input Level Dmod [%]	-100...+100	Sets the modulation amount of the input level
	Src	Off... Tempo	Selects the modulation source for the input level
h	Spread	0...50	Sets the width of the stereo image of the effect sound
i	Wet/Dry	Dry, 1:99...99:1, Wet	Balance between the wet and dry signal
	Src	Off... Tempo	See the list of DMS (Dynamic Modulation Sources) at the beginning of this part
	Amt	-100...+100	Amount of modulation source

■ a: Time Over?

You can set the delay time up to 5,460msec. If the delay time exceeds this limit, the error message “OVER!” appears in the display. Set the delay time parameters so that this message will not appear. “Time Over?” is only a display parameter.

Stereo BPM Delay

This stereo delay enables you to set the delay time to match the song tempo.

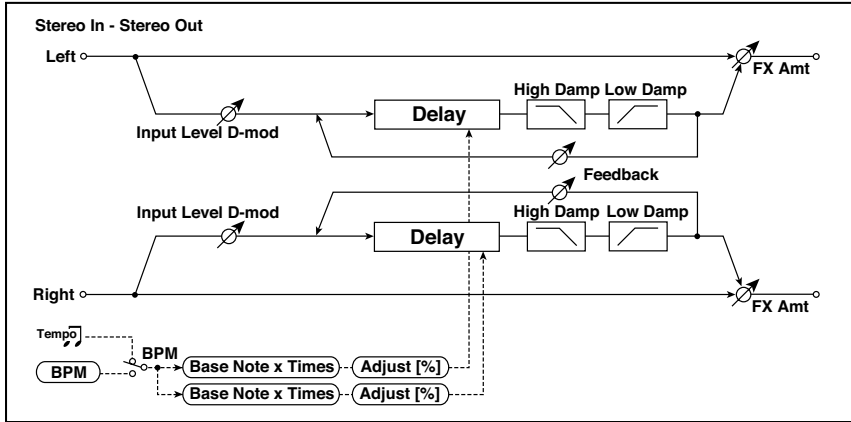

a	BPM	MIDI, 40.00... 300.00	MIDI syncs to the system tempo; 40–300 sets the tempo manually for this individual effect
	Time Over? L	---, OVER!	Display the error message if the left channel delay time exceeds the upper limit
	R	---, OVER!	Display the error message if the right channel delay time exceeds the upper limit
b	L Delay Base Note		Selects the type of notes to specify the left channel delay time
	Times	x1...x32	Sets the number of notes to specify the left channel delay time
	Adjust [%]	-2.50... +2.50	Fine-adjust the left channel delay time
c	R Delay Base Note		Selects the type of notes to specify the right channel delay time
	Times	x1...x32	Sets the number of notes to specify the right channel delay time
	Adjust [%]	-2.50... +2.50	Fine-adjust the right channel delay time
d	L Feedback	-100...+100	Sets the feedback amount for the left channel
	Src	Off... Tempo	Selects the modulation source of feedback amount
	Amt L	-100...+100	Sets the modulation amount of the left channel feedback

e	R Feedback	-100...+100	Sets the feedback amount for the right channel
	Amt R	-100...+100	Sets the modulation amount of the right channel feedback
f	High Damp [%]	0...100	Sets the damping amount in the high range
g	Low Damp [%]	0...100	Sets the damping amount in the low range
h	Input Level Dmod [%]	-100...+100	Sets the modulation amount of the input level
	Src	Off... Tempo	Selects the modulation source for the input level
i	Wet/Dry	Dry, 1:99...99:1, Wet	Balance between the wet and dry signal
	Src	Off... Tempo	See the list of DMS (Dynamic Modulation Sources) at the beginning of this part
	Amt	-100...+100	Amount of modulation source

■ a: Time Over? L, R

You can set the delay time up to 2,730msec. If the delay time exceeds this limit, the error message “OVER!” appears in the display. Set the delay time parameters so that this message will not appear. “Time Over?” is only a display parameter.

Stereo BPM Multitap Delay

This four-tap delay enables you to select a tempo and rhythm pattern to set up each tap.

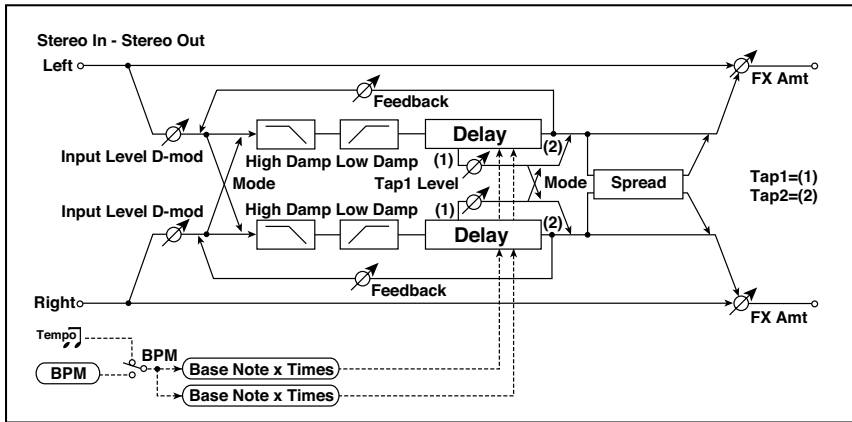



a	Mode	Normal, Cross Feedback, Cross Pan1, Cross Pan2	Switches the left and right delay routing
b	BPM	MIDI, 40.00... 300.00	MIDI syncs to the system tempo; 40–300 sets the tempo manually for this individual effect
	Time Over? 1	---, OVER!	Displays an error message when the delay time for Tap1 exceeds the upper limit
	2	---, OVER!	Displays an error message when the delay time for Tap2 exceeds the upper limit
c	Tap 1 Base Note		Selects the type of notes to specify the delay time for Tap1
	Times	x1...x32	Sets the number of notes to specify the delay time for Tap1
d	Tap 2 Base Note		Selects the type of notes to specify the delay time for Tap2
	Times	x1...x32	Sets the number of notes to specify the delay time for Tap2
e	Tap1 Level	0...100	Sets the Tap1 output level

f	Feedback (Tap2)	-100...+100	Sets the Tap2 feedback amount
	Src	Off...Tempo	Selects the modulation source of the Tap2 feedback amount
	Amt	-100...+100	Sets the modulation amount of the Tap2 feedback amount
g	High Damp [%]	0...100	Sets the damping amount in the high range
	Low Damp [%]	0...100	Sets the damping amount in the low range
h	Input Level Dmod [%]	-100...+100	Sets the modulation amount of the input level
	Src	Off...Tempo	Selects the modulation source for the input level
i	Spread	-100...+100	Sets the width of the stereo image of the effect sound
	Src	Off...Tempo	Selects the modulation source of the effect sound's stereo image width
	Amt	-100...+100	Sets the modulation amount of the effect sound's stereo image width
j	Wet/Dry	Dry, 1:99...99:1, Wet	Balance between the wet and dry signal
	Src	Off...Tempo	See the list of DMS (Dynamic Modulation Sources) at the beginning of this part
	Amt	-100...+100	Amount of modulation source

Stereo BPM Mod Delay

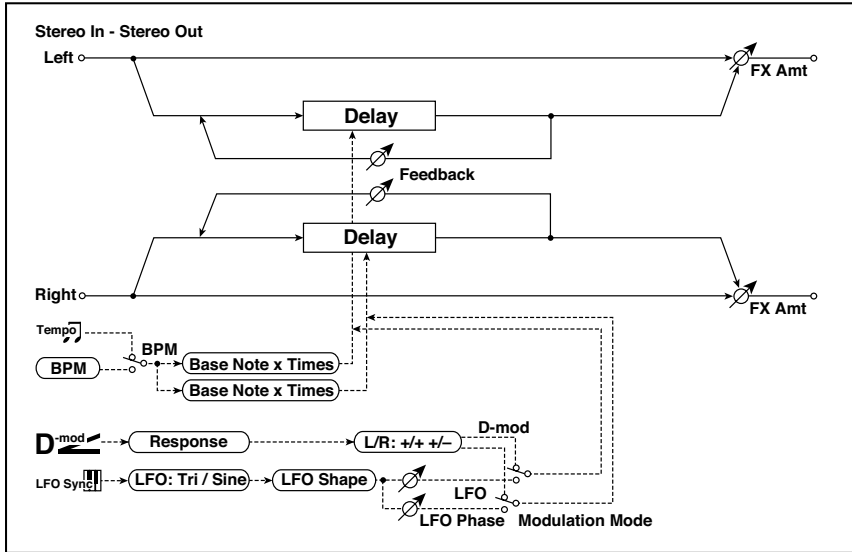
This is a stereo modulation delay that lets you synchronize the delay time to the tempo of the song.



a	Modulation Mode	LFO, D-mod	Switches between LFO modulation control and modulation source control
b	D-mod Modulation	L/R:+/+, L/R:+/-	Reversed L/R control by modulation source
	Src	Off...Tempo	Selects the modulation source that controls delay time
	Response	0...30	Sets the rate of response to the modulation source
c	LFO Waveform	Triangle, Sine	Selects the LFO Waveform
	LFO Shape	-100...+100	Changes the curvature of the LFO Waveform
d	LFO Sync	Off, On	Switches LFO reset off/on
	Src	Off...Tempo	Selects the modulation source that resets the LFO
e	LFO Frequency [Hz]	0.02...20.00	Sets the speed of the LFO
f	MIDI Sync	Off, On	When this is on, the LFO speed is set by BPM, Base Note, and Times, instead of Frequency
	BPM	MIDI, 40.00... 300.00	MIDI syncs to the system tempo; 40-300 sets the tempo manually for this individual effect
	Base Note		Selects the type of notes that specify the LFO speed
	Times	x1...x32	Sets the number of notes that specify the LFO speed
g	L LFO Phase [deg]	-180...+180	Sets the phase obtained when the left LFO is reset
	Depth	0...200	Sets the depth of the left LFO modulation
h	R LFO Phase [deg]	-180...+180	Sets the phase obtained when the right LFO is reset
	Depth	0...200	Sets the depth of the right LFO modulation
i	BPM(Delay)	MIDI, 40.00... 300.00	MIDI syncs to the system tempo; 40-300 sets the tempo manually for this individual effect
	Time Over? L	---, OVER!	Display the error message if the left channel delay time exceeds the upper limit
	R	---, OVER!	Display the error message if the right channel delay time exceeds the upper limit
j	L Delay Base Note		Selects the type of notes to specify the left channel delay time
	Times	x1...x32	Sets the number of notes to specify the left channel delay time
	Feedback	-100...+100	Sets the feedback amount of left delay

k	R Delay Base Note 		Selects the type of notes to specify the right channel delay time
	Times	x1...x32	Sets the number of notes to specify the right channel delay time
	Feedback	-100...+100	Sets the feedback amount of right delay
l	Wet/Dry	-Wet, -1:99... Dry...99:1, Wet	Balance between the wet and dry signal
	Src	Off...Tempo	See the list of DMS (Dynamic Modulation Sources) at the beginning of this part
	Amt	-100...+100	Amount of modulation source

■ i: Time Over? L, R

You can set the delay time up to 2,550msec. If the delay time exceeds this limit, the error message “OVER!” appears in the display. Set the delay time parameters so that this message will not appear. “Time Over?” is only a display parameter.

Stereo BPM AutoPan Delay

This stereo auto panning delay enables you to set the delay time to match the song tempo.

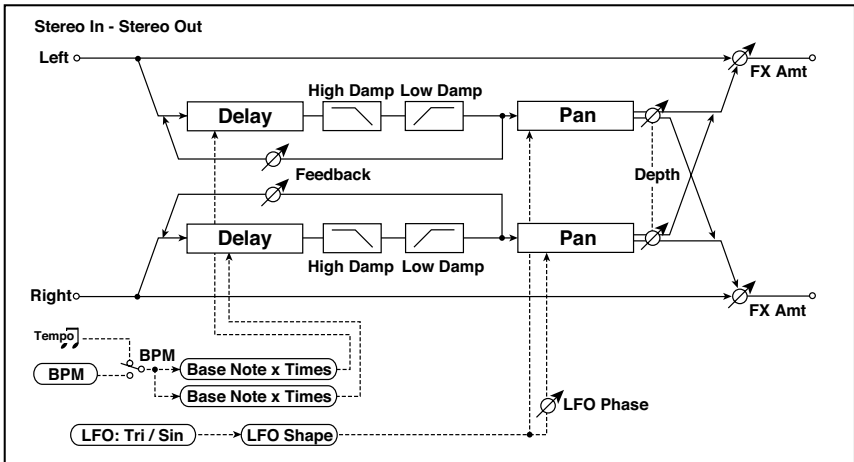

a	BPM	MIDI, 40.00... 300.00	MIDI syncs to the system tempo; 40-300 sets the tempo manually for this individual effect
	Time Over? L	---, OVER!	Display the error message if the left channel delay time exceeds the upper limit
	R	---, OVER!	Display the error message if the right channel delay time exceeds the upper limit
b	L Delay Base Note		Selects the type of notes to specify the left channel delay time
	Times	x1...x32	Sets the number of notes to specify the left channel delay time
	Feedback	-100...+100	Sets the feedback amount for the left channel
c	R Delay Base Note		Selects the type of notes to specify the right channel delay time
	Times	x1...x32	Sets the number of notes to specify the right channel delay time
	Feedback	-100...+100	Sets the feedback amount for the right channel
d	High Damp [%]	0...100	Sets the damping amount in the high range
	Low Damp [%]	0...100	Sets the damping amount in the low range

e	LFO Waveform	Triangle, Sine	Selects the LFO Waveform
	Shape	-100...+100	Changes the curvature of the LFO Waveform
	LFO Phase	-180...+180	Sets the LFO phase difference between the left and right
f	Panning Freq [Hz]	0.02...20.00	Sets the panning speed
g	MIDI Sync	Off, On	When this is on, the pan LFO speed is set by BPM, Base Note, and Times, instead of Frequency
	BPM	MIDI, 40.00... 300.00	MIDI syncs to the system tempo; 40–300 sets the tempo manually for this individual effect
	Base Note		Selects the type of notes to specify the delay time for the panning speed
	Times	x1...x32	Sets the number of notes to specify the delay time for the panning speed
h	Panning Depth	0...100	Sets the panning width
	Src	Off...Tempo	Selects the modulation source for the panning width
	Amt	-100...+100	Set the modulation amount of the panning width
i	Wet/Dry	Dry, 1:99...99:1, Wet	Balance between the wet and dry signal
	Src	Off...Tempo	See the list of DMS (Dynamic Modulation Sources) at the beginning of this part
	Amt	-100...+100	Amount of modulation source

Tape Echo BPM

This is a tape echo that lets you synchronize the delay time to the tempo of the song.

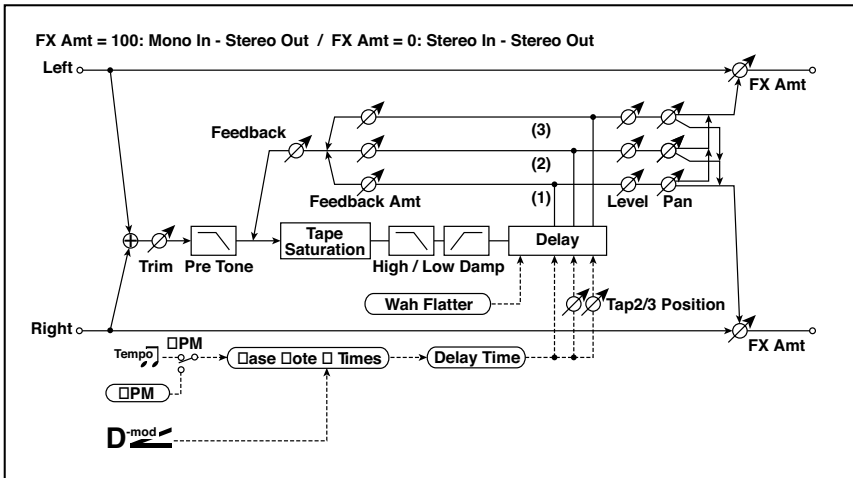

a	BPM (Delay)	MIDI, 40.00... 300.00	MIDI syncs to the system tempo; 40–300 sets the tempo manually for this individual effect
	Tap1 Dmod Src	Off...Tempo	Selects the modulation source of the delay time
b	Tap1 Delay Note		Selects the type of notes to specify the delay time (tap1)
	Times	x1...x32	Sets the number of notes to specify the delay time (tap1)
	Time Over?	---, OVER!	Displays an error message when the delay time exceeds the upper limit
c	Tap1 Dmod Note		Selects the note value used to specify the delay time when the modulation is at maximum
	Times	x1...x32	Specifies the number of notes used to specify the delay time when the modulation is at maximum
d	Tap2 Position [%]	0...100	Sets the position of Tap 2 relative to the Tap 1 delay time the depth of pitch variation
e	Tap3 Position [%]	0...100	Sets the position of Tap 3 relative to the Tap 1 delay time the depth of pitch variation
f	Tap1 Level	0...100	Sets the Tap1 output level
	Pan	L, 1...99, R	Sets the stereo image of tap1
	FB Amt	-100...+100	Sets the Tap1 feedback amount

g	Tap2 Level	0...100	Sets the Tap2 output level
	Pan	L, 1...99, R	Sets the stereo image of tap2
	FB Amt	-100...+100	Sets the Tap2 feedback amount
h	Tap3 Level	0...100	Sets the Tap3 output level
	Pan	L, 1...99, R	Sets the stereo image of tap3
	FB Amt	-100...+100	Sets the Tap3 feedback amount
i	Feedback	0...100	Sets the amount of feedback for Taps 1, 2, and 3
	Src	Off...Tempo	Selects the modulation source of feedback amount
	Amt	-100...+100	Sets the depth by which feedback amount will be modulated
j	High Damp [%]	0...100	Sets the damping amount in the high range
	Low Damp [%]	0...100	Sets the damping amount in the low range
k	Saturation	0...100	Sets the distortion amount
l	Input Trim	0...100	Sets the input gain
	Pre Tone	0...100	Sets the tone of the input
m	Wow Flutter [Hz]	0.02...1.00	Sets the frequency at which pitch variation will occur
	Wow Flutter depth	0...100	Sets the depth of pitch variation
n	Wet/Dry	Dry, 1:99...99:1, Wet	Balance between the wet and dry signal
	Src	Off...Tempo	See the list of DMS (Dynamic Modulation Sources) at the beginning of this part
	Amt	-100...+100	Amount of modulation source

- **a: Tap1 Dmod Src**
- **b: Tap1 Delay Note**
- **b: Times**
- **c: Tap1 Dmod Note**
- **c: Times**

If “Tap1 Dmod Src” is Off or the selected modulation is at 0, the delay time will be the length specified by “Tap1 Delay Note” and “Times.”

If “Tap1 Dmod Src” is other than Off, the delay time will change so that it will be as specified by “Tap1 Dmod Note” and “Times” when the maximum modulation is reached.

■ **b: Time Over?**

You can set the delay time up to 5,400msec. If the delay time exceeds this limit, the error message “OVER!” appears in the display. Set the delay time parameters so that this message will not appear. “Time Over?” is only a display parameter.

L/C/R Long Delay

This multitap delay outputs three Tap signals to left, right and center respectively. You can set a maximum of 5,460msec for the delay time.

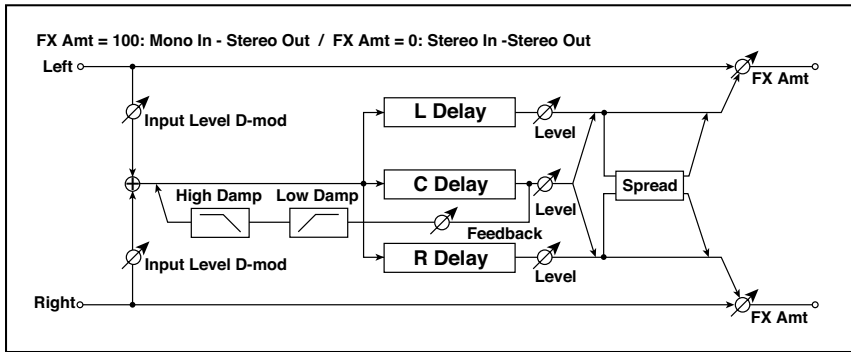

a	L Delay Time [msec]	0...5460	Sets the delay time of TapL
	Level	0...50	Sets the output level of TapL
b	C Delay Time [msec]	0...5460	Sets the delay time of TapC
	Level	0...50	Sets the output level of TapC
c	R Delay Time [msec]	0...5460	Sets the delay time of TapR
	Level	0...50	Sets the output level of TapR
d	Feedback (C Delay)	-100...+100	Sets the feedback amount of TapC
	Src	Off...Tempo	Selects the modulation source for the TapC feedback
	Amt	-100...+100	Sets the modulation amount of the TapC feedback
e	High Damp [%]	0...100	Sets the damping amount in the high range
	Low Damp [%]	0...100	Sets the damping amount in the low range
f	Input Level Dmod [%]	-100...+100	Sets the modulation amount of the input level
	Src	Off...Tempo	Selects the modulation source for the input level
g	Spread	0...50	Sets the width of the stereo image of the effect sound

h	Wet/Dry	Dry, 1:99...99:1, Wet	Balance between the wet and dry signal
	Src	Off...Tempo	See the list of DMS (Dynamic Modulation Sources) at the beginning of this part
	Amt	-100...+100	Amount of modulation source

St/Cross Long Delay (Stereo/Cross Long Delay)

This is a stereo delay, and can be used as a cross-feedback delay effect in which the delay sounds cross over between left and right by changing the feedback routing. You can set a maximum of 2,730msec for the delay time.

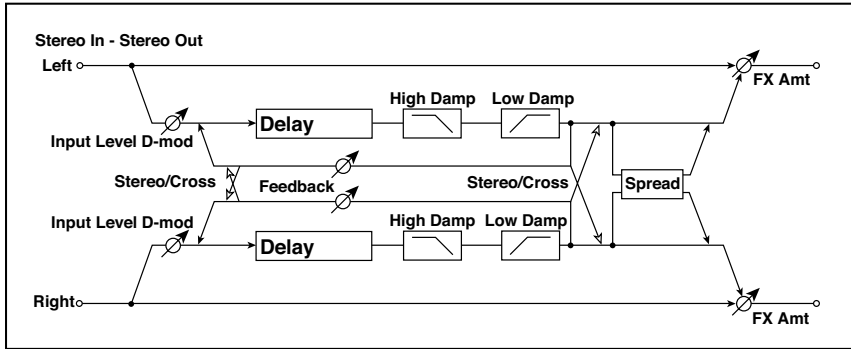

a	Stereo/Cross	Stereo, Cross	Switches between stereo delay and cross-feedback delay
b	L Delay Time [msec]	0.0...2730.0	Sets the delay time for the left channel
c	R Delay Time [msec]	0.0...2730.0	Sets the delay time for the right channel
d	L Feedback	-100...+100	Sets the feedback amount for the left channel
	Src	Off...Tempo	Selects the modulation source of feedback amount
	Amt	-100...+100	Sets the modulation amount of the left channel feedback
e	R Feedback	-100...+100	Sets the feedback amount for the right channel
	Amt	-100...+100	Sets the modulation amount of the right channel feedback
f	High Damp [%]	0...100	Sets the damping amount in the high range
g	Low Damp [%]	0...100	Sets the damping amount in the low range
h	Input Level Dmod [%]	-100...+100	Sets the modulation amount of the input level
	Src	Off...Tempo	Selects the modulation source for the input level
i	Spread	-50...+50	Sets the width of the stereo image of the effect sound

j	Wet/Dry	Dry, 1:99...99:1, Wet	Balance between the wet and dry signal
	Src	Off...Tempo	See the list of DMS (Dynamic Modulation Sources) at the beginning of this part
	Amt	-100...+100	Amount of modulation source

Hold Delay

This effect records the input signal and plays it back repeatedly. You can control the start of recording and reset via a modulation source. Easy to use for real-time performances.

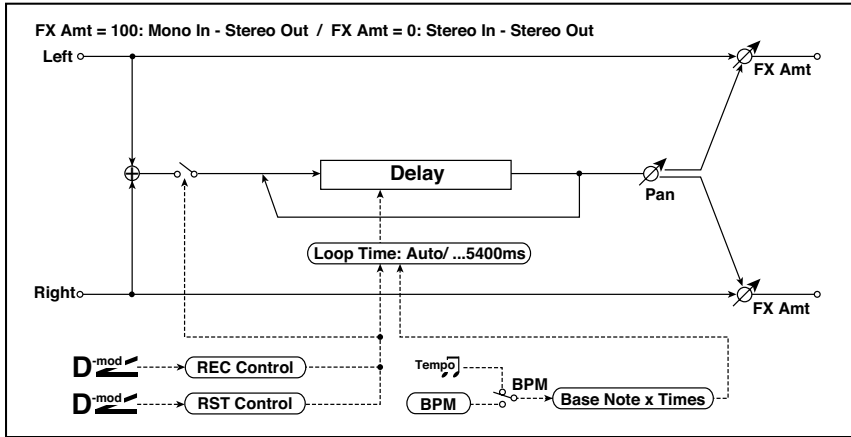

a	Loop Time [msec]	Auto, 1...10800	Sets Automatic loop time setup mode or specifies loop time
b	Loop BPM Sync	Off, On	Specifies whether delay time is set in milliseconds, or as a note value relative to tempo
c	BPM	MIDI, 40.00... 300.00	MIDI syncs to the system tempo; 40-300 sets the tempo manually for this individual effect
	Time Over?	---, OVER!	An error indication that appears if delay time exceeds the upper limit when MIDI/Tempo Sync=On
d	Loop Base Note		Selects the type of notes to specify the delay time
	Times	x1...x32	Sets the number of notes to specify the delay time
e	REC Control Src	Off...Tempo	Selects control source for recording
f	RST Control Src	Off...Tempo	Selects control source for reset
g	Manual REC Control	REC Off, REC On	Sets the recording switch
h	Manual RST Control	Off, RESET	Sets the reset switch

i	Pan	L100...L1, C, R1... R100	Sets the stereo image of the effect
	Src	Off...Tempo	Selects the modulation source of stereo image of the effect
	Amt	-100...+100	Sets the modulation amount of stereo image of the effect
j	Wet/Dry	Dry, 1:99...99:1, Wet	Balance between the wet and dry signal
	Src	Off...Tempo	See the list of DMS (Dynamic Modulation Sources) at the beginning of this part
	Amt	-100...+100	Amount of modulation source

■ a: Loop Time [msec]

With Auto, the loop time is automatically set. Otherwise, you can specify the loop time.

When Auto is selected, the Loop Time is automatically set to the time it takes for a performance recorded while the Modulation Source or “Manual REC Control” is on. However, if the time length exceeds 10,800msec, the loop time will be automatically set to 10,800msec.

■ c: Time Over?

You can set the delay time up to 10,800msec. If the delay time exceeds this limit, the error message “OVER!” appears in the display. Set the delay time parameters so that this message will not appear. “Time Over?” is only a display parameter.

■ b: Loop BPM Sync

■ c: BPM

■ d: Loop Base Note

■ d: Times

If “Loop BPM Sync” is on, the “Times” setting is ignored; the loop time is determined by “BPM,” “Loop Base Note,” and “Times.” Even in this case, the delay time cannot exceed 10,800 msec.

■ “Hold” procedure (when Loop Time = Auto)

1 Select the following options for each parameter:

Parameter	Option
Loop Time [msec]	Auto
REC Control Src	JS +Y: #01
RST Control Src	JS -Y: #02
Manual REC Control	REC Off
Manual RST Control	RESET
Loop BPM Sync	Off

It should be noted that all recordings will be deleted while Reset is On.

2 Set “Manual RST Control” = Off

Reset is cancelled and the unit enters Rec ready mode.

3 Push the joystick in the +Y direction (forward) and play a phrase you wish to hold. When you pull the joystick to its original position, the recording will be finished and the phrase you just played will be held.

Loop Time is automatically set only for the first recording after resetting. If the time length exceeds 10,800msec, Loop Time will be automatically set to 10,800msec. (If you have set “Times” to 1-10,800msec, the specified loop time will be used regardless of the time taken from pushing the joystick forward until it is pulled back. However, the recording method remains the same. The phrase being played while the joystick is pushed forward will be held.)

4 If you made a mistake during recording, pull the joystick in the -Y direction (back) to reset. In this way, the recording will be erased. Repeat step 4. again.

5 The recorded phrase will be repeated again and again. You can use this to create an accompaniment.

6 By pushing the joystick in the +Y direction (forward), you can also overdub performances over the phrase that is being held.

■ e: REC Control Src

■ g: Manual REC Control

“REC Control Src” selects the modulation source that controls recording.

If this modulation is on, or if “Manual REC Control” is set to On, you can record the input signal. If a recording has already been carried out, additional signals will be overdubbed.

MIDI The effect is off when a value for the modulation source specified for the “REC Control Src” parameter is 63 or smaller, and the effect is on when the value is 64 or higher.

- **f: RST Control Src**

- **h: Manual RST Control**

The “RST Control Src” parameter specifies the modulation source that controls the reset operation.

When you set this modulation source to On, or “Manual RST Control” to RESET, you can erase what you recorded. If the Loop Time parameter has been set to Auto, the loop time is also reset.

MIDI The effect is off when a value for the modulation source specified for the “RST Control Src” parameter is 63 or smaller, and the effect is on when the value is 64 or higher.

LCR BPM Long Delay

The L/C/R delay enables you to match the delay time with the song tempo.

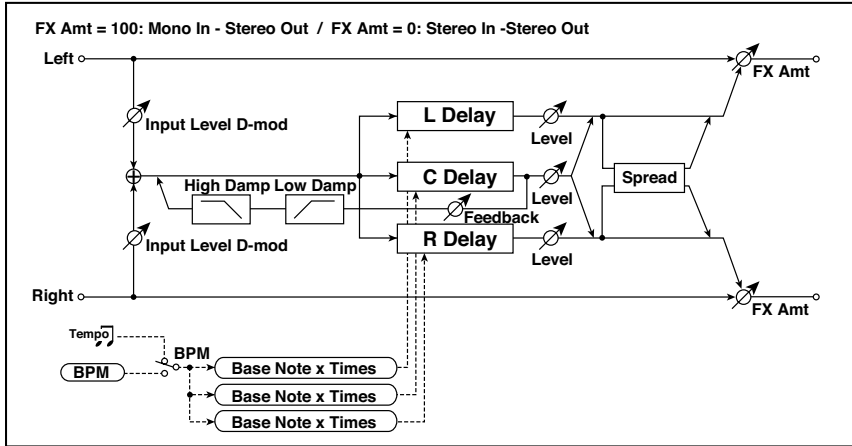

a	BPM	MIDI, 40.00... 300.00	MIDI syncs to the system tempo; 40–300 sets the tempo manually for this individual effect
	Time Over?	---, OVER!	Displays an error message when the delay time exceeds the upper limit
b	L Delay Base Note		Selects the type of notes to specify the delay time for TapL
	Times	x1...x32	Sets the number of notes to specify the delay time for TapL
	Level	0...50	Sets the output level of TapL
c	C Delay Base Note		Selects the type of notes to specify the delay time for TapC
	Times	x1...x32	Sets the number of notes to specify the delay time for TapC
	Level	0...50	Sets the output level of TapC
d	R Delay Base Note		Selects the type of notes to specify the delay time for TapR
	Times	x1...x32	Sets the number of notes to specify the delay time for TapR
	Level	0...50	Sets the output level of TapR

e	Feedback (C Delay)	-100...+100	Sets the feedback amount of TapC
	Src	Off...Tempo	Selects the modulation source for the TapC feedback
	Amt	-100...+100	Sets the modulation amount of the TapC feedback
f	High Damp [%]	0...100	Sets the damping amount in the high range
	Low Damp [%]	0...100	Sets the damping amount in the low range
g	Input Level Dmod [%]	-100...+100	Sets the modulation amount of the input level
	Src	Off...Tempo	Selects the modulation source for the input level
h	Spread	0...50	Sets the width of the stereo image of the effect sound
i	Wet/Dry	Dry, 1:99...99:1, Wet	Balance between the wet and dry signal
	Src	Off...Tempo	See the list of DMS (Dynamic Modulation Sources) at the beginning of this part
	Amt	-100...+100	Amount of modulation source

■ a: Time Over?

You can set the delay time up to 10,920msec. If the delay time exceeds this limit, the error message “OVER!” appears in the display. Set the delay time parameters so that this message will not appear. “Time Over?” is only a display parameter.

Stereo BPM Long Delay

The stereo delay enables you to match the delay time with the song tempo.

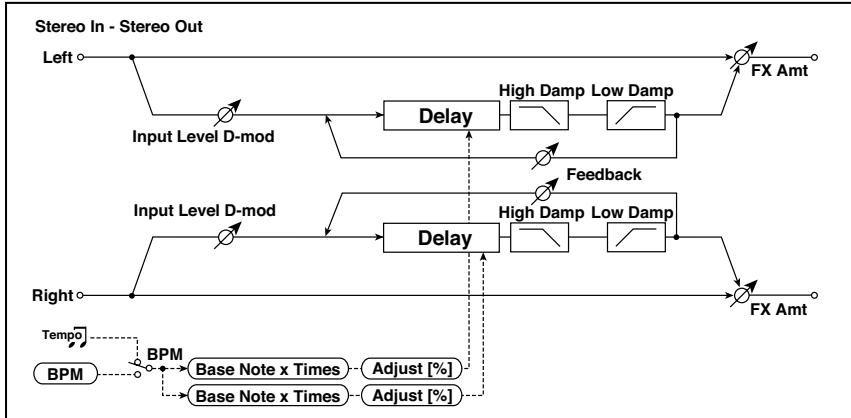

a	BPM	MIDI, 40.00... 300.00	MIDI syncs to the system tempo; 40–300 sets the tempo manually for this individual effect
	Time Over? L	---, OVER!	Display the error message if the left channel delay time exceeds the upper limit
	R	---, OVER!	Display the error message if the right channel delay time exceeds the upper limit
b	L Delay Base Note		Selects the type of notes to specify the left channel delay time
	Times	x1...x32	Sets the number of notes to specify the left channel delay time
	Adjust [%]	-2.50...+2.50	Fine-adjust the left channel delay time
c	R Delay Base Note		Selects the type of notes to specify the right channel delay time
	Times	x1...x32	Sets the number of notes to specify the right channel delay time
	Adjust [%]	-2.50...+2.50	Fine-adjust the right channel delay time
d	L Feedback	-100...+100	Sets the feedback amount for the left channel
	Src	Off...Tempo	Selects the modulation source of feedback amount
	L Amt	-100...+100	Sets the modulation amount of the left channel feedback

e	R Feedback	-100...+100	Sets the feedback amount for the right channel
	R Amt	-100...+100	Sets the modulation amount of the right channel feedback
f	High Damp [%]	0...100	Sets the damping amount in the high range
g	Low Damp [%]	0...100	Sets the damping amount in the low range
h	Input Level Dmod [%]	-100...+100	Sets the modulation amount of the input level
	Src	Off...Tempo	Selects the modulation source for the input level
i	Wet/Dry	Dry, 1:99...99:1, Wet	Balance between the wet and dry signal
	Src	Off...Tempo	See the list of DMS (Dynamic Modulation Sources) at the beginning of this part
	Amt	-100...+100	Amount of modulation source

■ a: Time Over? L, R

You can set the delay time up to 5,460msec. If the delay time exceeds this limit, the error message “OVER!” appears in the display. Set the delay time parameters so that this message will not appear. “Time Over?” is only a display parameter.

Classic Tape Echo

This models a famous analog tape echo unit. On the original device, “echo” was created by a playback head, and the “delay time” was specified by adjusting the speed of the motor. The warmth and subtlety of the echoes it generated made this “lo-fi” unit a favorite with many pro musicians.

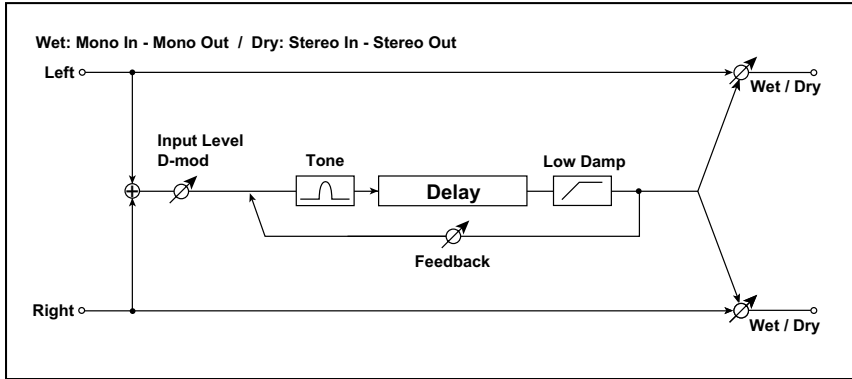

a	Time	0...2700	This parameter sets the delay time.
	Src	Off...Tempo	Selects the modulation source of Time
	Amt	-100...+100	Sets the depth by which Time will be modulated
b	Feedback	0...100	Sets the amount of feedback
	Src	Off...Tempo	Selects the modulation source of feedback amount
	Amt	-100...+100	Sets the depth by which feedback amount will be modulated
c	Tone	0...99	Sets the tone of the input. This models the reduced high frequencies of an analog tape delay, before the saturation stage. Lower settings create a darker tone. This cuts the high frequencies in both the main output and the feedback. Higher settings create a brighter tone.
d	Low Damp [%]	0...100	Sets the damping amount in the low range
e	Input Level Dmod	-100...+100	Amount of input level modulation
	Src	Off...Tempo	Selects the modulation source of Input Level Dmod. See the list of DMS (Dynamic Modulation Sources) at the beginning of this part

f	Wet/Dry	Dry, 1:99...99:1, Wet	Balance between the wet and dry signal
	Src	Off...Tempo	See the list of DMS (Dynamic Modulation Sources) at the beginning of this part
	Amt	-100...+100	Amount of modulation source

Dynamics

Stereo Compressor

This effect compresses the input signal to regulate the level and give a “punchy” effect. It is useful for guitar, piano, and drum sounds. This is a stereo compressor. You can link left and right channels, or use each channel separately.

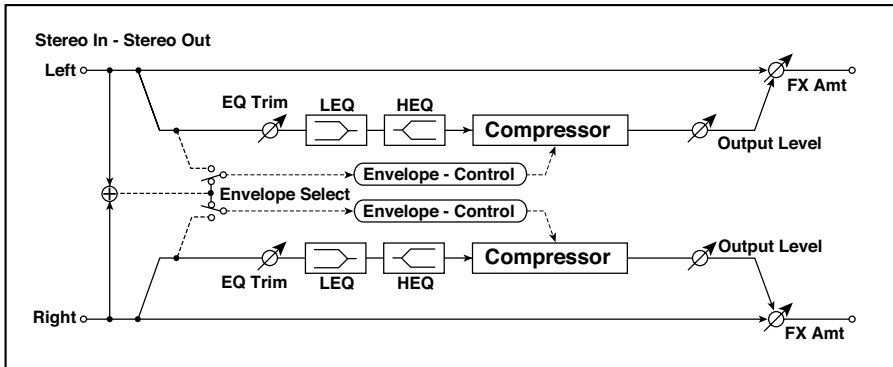

a	Envelope Select	L/R Mix, L/R Individually	Determines whether the left and right channels are linked or used separately
b	Sensitivity	1...100	Sets the sensitivity
c	Attack	1...100	Sets the attack level
d	EQ Trim	0...100	Sets the EQ input level
e	Pre LEQ Fc	Low, Mid-Low	Selects the cutoff frequency (low or mid-low) of the low-range equalizer
	Pre HEQ Fc	High, Mid-High	Selects the cutoff frequency (high or mid-high) of the high-range equalizer
f	Pre LEQ Gain [dB]	-15.0...+15.0	Sets the gain of the Low EQ
	Pre HEQ Gain [dB]	-15.0...+15.0	Sets the gain of the High EQ
g	Output Level	0...100	Sets the output level of the compressor
	Src	Off...Tempo	Selects the modulation source for the compressor output level
	Amt	-100...+100	Sets the modulation amount for the compressor output level

h	Wet/Dry	Dry, 1:99...99:1, Wet	Sets the Balance between the wet and dry signal
	Src	Off...Tempo	Selects a modulation source for Wet/Dry
	Amt	-100...+100	Sets the modulation amount for Wet/Dry

■ a: Envelope Select

This parameter selects whether the left and right channels are linked to control both signals simultaneously, or whether each channel is controlled independently.

■ b: Sensitivity

■ g: Output Level

The “Sensitivity” parameter sets the sensitivity of the compressor. If this parameter is set to a higher value, lower level sounds will be boosted. With a higher Sensitivity, the overall volume level is higher. To adjust the final volume level, use the “Output Level” parameter.

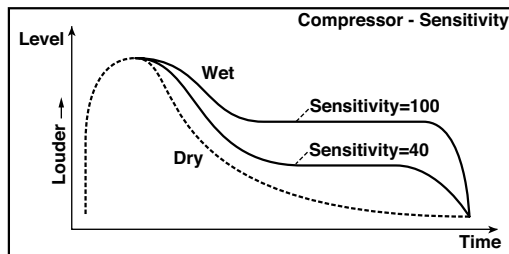

■ c: Attack

This parameter controls the attack level.

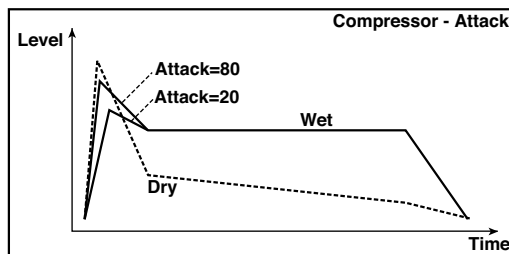

Stereo Limiter

The Limiter regulates the input signal level. It is similar to the Compressor, except that the Limiter compresses only signals that exceed the specified level to lower unnecessary peak signals. The Limiter applies a peaking-type EQ to the trigger signal (which controls the degree of the Limiter effect), allowing you to set any band width to be covered. This effect is a stereo limiter. You can link left and right channels, or use each channel individually.

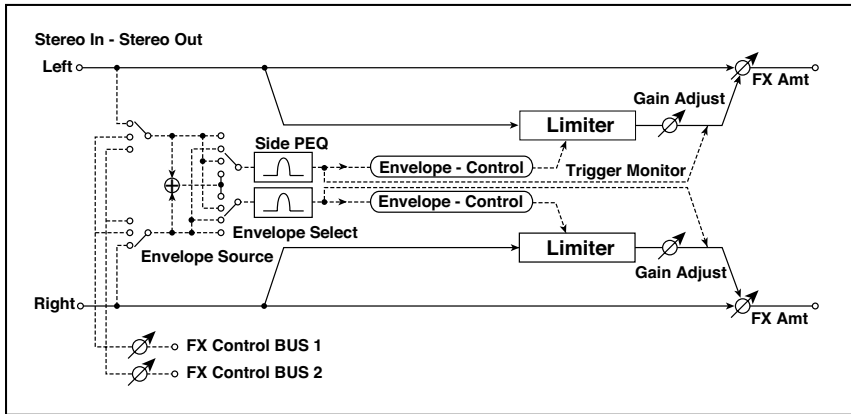

a	Envelope Select	L/R Mix, L Only, R Only, L/R Individually	Selects from linking both channels, controlling only from left channel, only from the right channel, or controlling each channel individually
b	Ratio	1.0 : 1... 50.0 : 1, Inf : 1	Sets the signal compression ratio
c	Threshold [dB]	-40...0	Sets the level above which the compressor is applied
v	Attack	1...100	Sets the attack time
	Release	1...100	Sets the release time
e	Gain Adjust [dB]	-Inf, -38...+24	Sets the output gain
	Src	Off...Tempo	Selects the modulation source for the output gain
	Amt	-63...+63	Sets the modulation amount of the output gain
f	Side PEQ Insert	Off, On	Toggles between on/off of the trigger signal's EQ
	Trigger Monitor	Off, On	Switches between effect output monitor and trigger signal monitor

g	Side PEQ Cutoff [Hz]	20...12.00k	Sets the EQ center frequency for the trigger signal
	Q	0.5...10.0	Sets the EQ bandwidth for the trigger signal
	Gain [dB]	-18.0...+18.0	Sets the EQ gain for the trigger signal
h	Wet/Dry	Dry, 1:99...99:1, Wet	Balance between the wet and dry signal
	Src	Off...Tempo	Dynamic Modulation sources
	Amt	-100...+100	Amount of modulation source

■ a: Envelope Select

When L/R Mix is selected for this parameter, the left and right channels are linked to control the Limiter using the mixed signal. If L Only (or R Only) is selected, the left and right channels are linked, and the Limiter is controlled via only the left (or right) channel.

With L/R individually, the left and right channels control the Limiter individually.

■ b: Ratio

■ c: Threshold [dB]

■ e: Gain Adjust [dB]

This parameter sets the signal compression “Ratio”. Compression is applied only when the signal level exceeds the “Threshold” value.

Adjust the output level using the “Gain Adjust” parameter, since compression causes the entire level to be reduced.

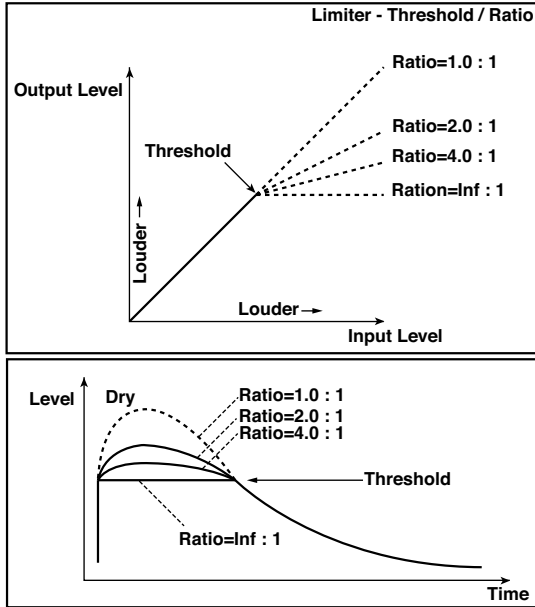

- **d: Attack**
- **d: Release**

These parameters set the attack time and release time. A higher attack time will cause the compression to be applied more slowly.

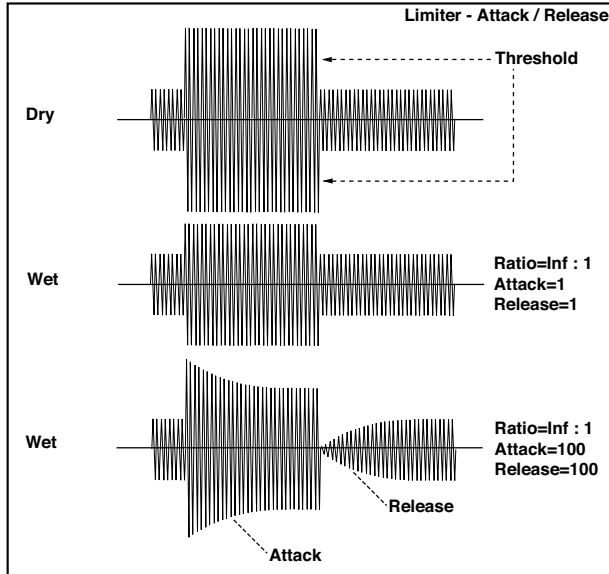

- **f: Trigger Monitor**

Setting this parameter On will cause the trigger signal to be output, instead of the effect sound. Use this parameter to check the trigger signal with EQ applied.

Usually, set this to Off.

- **f: Side PEQ Insert**
- **g: Side PEQ Cutoff [Hz]**
- **g: Q**
- **g: Gain [dB]**

These parameters are used to set the EQ applied to the trigger signal.

The Limiter determines whether the compression is applied or not, based on the post-EQ trigger signal. Setting the equalizer allows you to set the Limiter to respond to any frequency band.

Multiband Limiter

This effect applies the Limiter to the low range, mid range, and high range of the input signal. You can control dynamics for each range to adjust the sound pressure of the low range, mid range, and high range in a different way from the EQ.

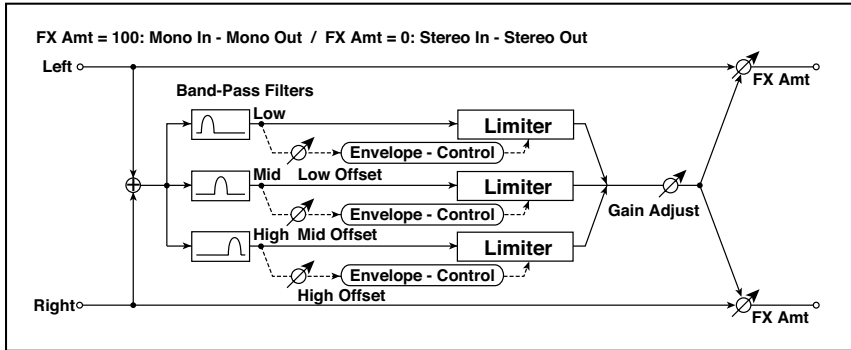

a	Ratio	1.0 : 1...50.0 : 1, Inf : 1	Sets the signal compression ratio
b	Threshold [dB]	-40...0	Sets the level above which the compressor is applied
c	Attack	1...100	Sets the attack time
d	Release	1...100	Sets the release time
e	Low Offset [dB]	-40...0	Gain of the low-range trigger signal
f	Mid Offset [dB]	-40...0	Gain of the mid-range trigger signal
g	High Offset [dB]	-40...0	Gain of the high-range trigger signal
h	Gain Adjust [dB]	-Inf, -38...+24	Sets the output gain
	Src	Off...Tempo	Selects the modulation source for the output gain
	Amt	-63...+63	Sets the modulation amount of the output gain
i	Wet/Dry	Dry, 1:99...99:1, Wet	Balance between the wet and dry signal
	Src	Off...Tempo	See the list of DMS (Dynamic Modulation Sources) at the beginning of this part
	Amt	-100...+100	Amount of modulation source

-
- **e: Low Offset [dB]**

 - **f: Mid Offset [dB]**

 - **g: High Offset [dB]**

These parameters set the gain of the trigger signal.

For example, if you do not want to apply compression to the high range, reduce the “High Offset” value down below the “Threshold” level. In this way, the high range limiter will not respond, and compression will not be applied.

Stereo Mastering Limiter

This is a stereo limiter that is optimized for mastering songs.

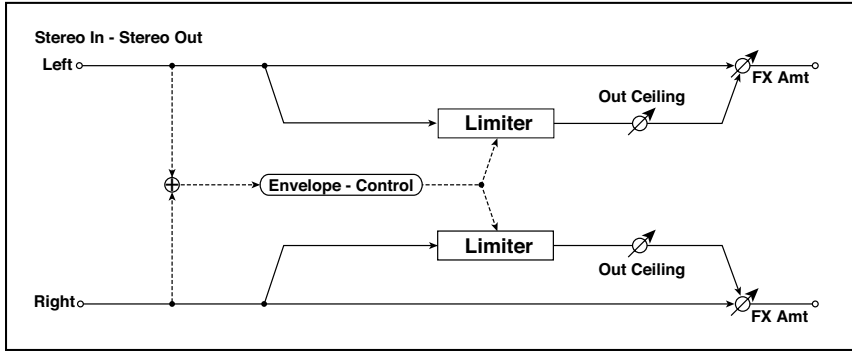

a	Threshold [dB]	-30.0...0.0	Sets the level above which the compressor is applied
b	Out Ceiling [dB]	-30.0...0.0	Sets the output gain
c	Release [msec]	0.50...1000.0	Sets the release time
d	Wet/Dry	Dry, 1:99...99:1, Wet	Balance between the wet and dry signal
	Src	Off...Tempo	See the list of DMS (Dynamic Modulation Sources) at the beginning of this part
	Amt	-100...+100	Amount of modulation source

Stereo Gate

This effect mutes the input signal when it falls below a specified level. You can also invert the on/off status of the gate, or use note-on/off messages to turn the gate on/off directly.

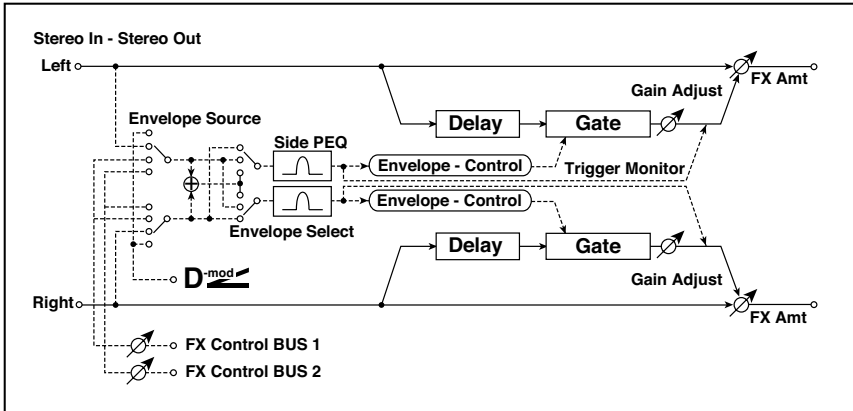

a	Envelope Source	D-mod, Input	Selects the source to control the gate: D-mod control, or use the input signal as a trigger
b	Envelope Select	L/R Mix, L Only, R Only	Selects the control signal: left and right linked, left only, or right only
	Src	Off...Tempo	Selects the source that will control the gate when Envelope Src = D-mod
c	Threshold	0...100	Sets the level at which gating is applied
	Polarity	+, -	Switches the polarity of gating
d	Attack	1...100	Sets the attack time
	Release	1...100	Sets the release time
e	Delay Time [msec]	0...100	Sets the delay time for the gate input
f	Side PEQ Insert	Off, On	Switches the trigger signal equalizer on/off
	Trigger Monitor	Off, On	Switches between monitoring the effect output and the trigger signal
g	Side PEQ Cutoff [Hz]	20...12.00k	Sets the center frequency of the equalizer for the trigger signal
	Q	0.5...10.0	Sets the bandwidth of the equalizer for the trigger signal
	Gain [dB]	-18.0...+18.0	Sets the gain of the equalizer for the trigger signal

h	Wet/Dry	Dry, 1:99...99:1, Wet	Balance between the wet and dry signal
	Src	Off...Tempo	See the list of DMS (Dynamic Modulation Sources) at the beginning of this part
	Amt	-100...+100	Amount of modulation source

- **c: Threshold**

- **d: Attack**

- **d: Release**

“Threshold” specifies the level at which gating occurs when “Envelope Select” is set to L/R Mix, L Only, or R Only.

“Attack” and “Release” specify the attack time and release time of the gate.

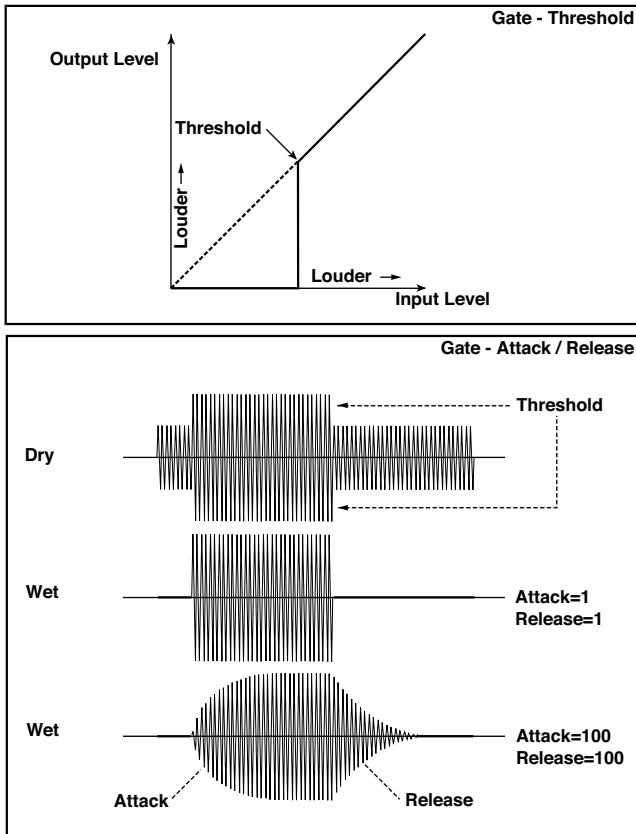

■ c: Polarity

This inverts the polarity of the gate on/off operation. With the “-” setting, the gate will close when the input signal exceeds the specified level. The direction in which the modulation source opens or closes the gate will also be reversed.

■ e: Delay Time [msec]

This sets the delay time for the input to the gate. When using shorter Attack Time settings, you can lengthen the Delay Time so that the sound is input after the gate opens.

Stereo Multiband Limiter

This is a stereo multiband limiter.

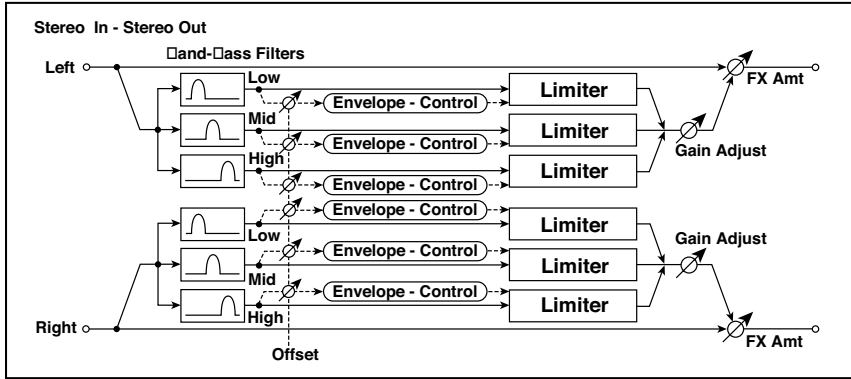

a	Ratio	1.0 : 1... 50.0 : 1, Inf : 1	Sets the signal compression ratio
b	Threshold [dB]	-40...0	Sets the level above which the compressor is applied
c	Attack	1...100	Sets the attack time
d	Release	1...100	Sets the release time
e	Low Offset [dB]	-40...0	Sets the low range gain of trigger signal
f	Mid Offset [dB]	-40...0	Sets the mid range gain of trigger signal
g	High Offset [dB]	-40...0	Sets the high range gain of trigger signal
h	Gain Adjust [dB]	-Inf, -38...+24	Sets the output gain
	Src	Off...Tempo	Selects the modulation source for the output gain
	Amt	-63...+63	Sets the modulation amount of the output gain
i	Wet/Dry	Dry, 1:99...99:1, Wet	Balance between the wet and dry signal
	Src	Off...Tempo	See the list of DMS (Dynamic Modulation Sources) at the beginning of this part
	Amt	-100...+100	Amount of modulation source

Dynamic Compressor

This effect reduces the dynamic range of the input signal, to regulate the level and give a ‘punchy’ effect. It is useful for guitar, piano, and drum sounds. This is a true stereo effect; you can link the left and right channels, or use each channel separately.

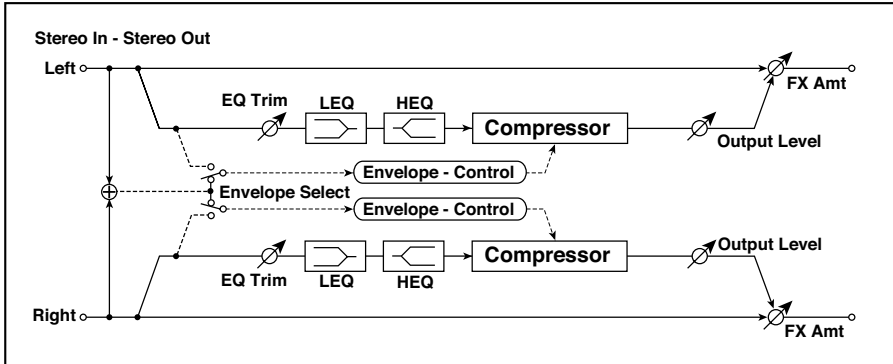

a	Sensitivity	1...100	This controls the amount of compression. Increasing the value boosts lower level sounds, and raises the overall volume. To adjust the final volume, use the Level parameter.
b	Attack	1...100	Sets the attack level
c	Level	0...100	Sets the output level of the compressor
	Src	Off...Tempo	Selects the modulation source for the compressor output level
	Amt	-100...+100	Sets the modulation amount for the compressor output level
d	Wet/Dry	Dry, 1:99...99:1, Wet	Sets the Balance between the wet and dry signal
	Src	Off...Tempo	Selects a modulation source for Wet/Dry
	Amt	-100...+100	Sets the modulation amount for Wet/Dry

Filter (EQ and Filters)

Stereo Parametric 4EQ

This is a stereo 4-band parametric equalizer. You can select peaking type or shelving type for Band 1 and 4. The gain of Band 2 can be controlled by dynamic modulation.

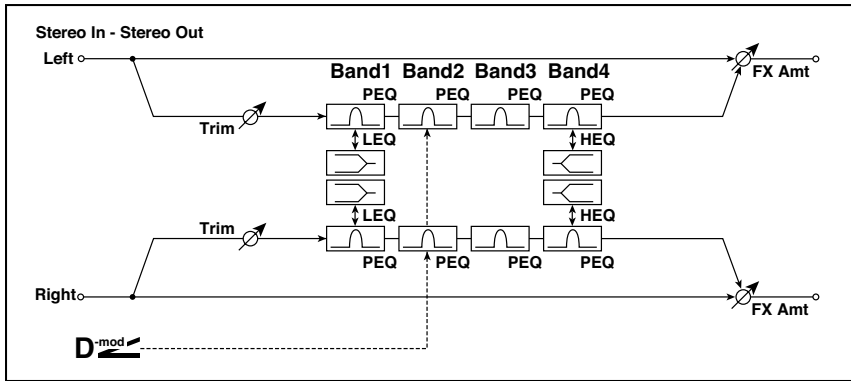

a	Trim	0...100	Sets the input level
b	Band1 Type	Peaking, Shelving-Low	Selects the type of Band 1
c	Band4 Type	Peaking, Shelving-High	Selects the type of Band 4
d	Band2 Dynamic Gain Src	Off...Tempo	Selects the modulation source of the Band 2 gain
	Amt [dB]	-18.0...+18.0	Sets the modulation amount of Band 2 gain
e	Band1 Cutoff [Hz]	20...1.00k	Sets the center frequency of Band 1
	Q	0.5...10.0	Sets the bandwidth of Band 1
	Gain [dB]	-18.0...+18.0	Sets the gain of Band 1
f	Band2 Cutoff [Hz]	50...10.00k	Sets the center frequency of Band 2
	Q	0.5...10.0	Sets the bandwidth of Band 2
	Gain [dB]	-18.0...+18.0	Sets the gain of Band 2
g	Band3 Cutoff [Hz]	300...10.00k	Sets the center frequency of Band 3
	Q	0.5...10.0	Sets the bandwidth of Band 3
	Gain [dB]	-18.0...+18.0	Sets the gain of Band 3

h	Band4 Cutoff [Hz]	500...20.00k	Sets the center frequency of Band 4
	Q	0.5...10.0	Sets the bandwidth of Band 4
	Gain [dB]	-18.0...+18.0	Sets the gain of Band 4
i	Wet/Dry	Dry, 1:99...99:1, Wet	Balance between the wet and dry signal
	Src	Off...Tempo	See the list of DMS (Dynamic Modulation Sources) at the beginning of this part
	Amt	-100...+100	Amount of modulation source

- **b: Band1 Type**

- **c: Band4 Type**

Selects a filter type for Band 1 and 4.

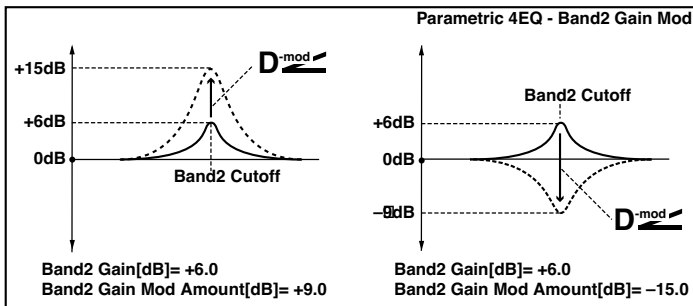
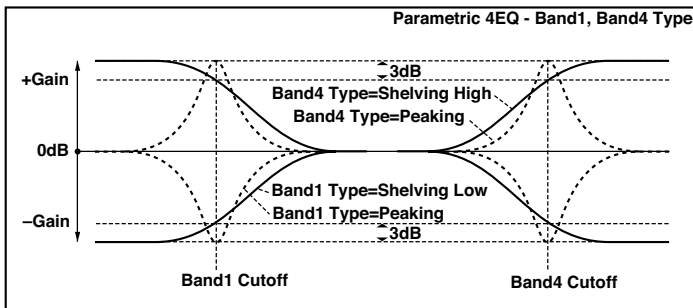

- **e, f, g, h: Q**

These parameters set the bandwidth of each equalizer. The higher the value, the narrower the band becomes.

-
- **d: Band2 Dynamic Gain Src**
 - **d: Amt [dB]**
-

You can control the gain of Band 2 using the modulation source.

Stereo 6 Band EQ

This is the same as the **Stereo Parametric 4EQ** effects, but with the addition of a high-pass and a low-pass filter (see [Stereo Parametric 4EQ](#) on page 1130).

Stereo Graphic 7EQ

This is a stereo 7-band graphic equalizer. The bar graph of the gain setting for each band gives you a clear, visual idea of frequency responses. You can select a center frequency setting for each band from twelve types, according to the sound.

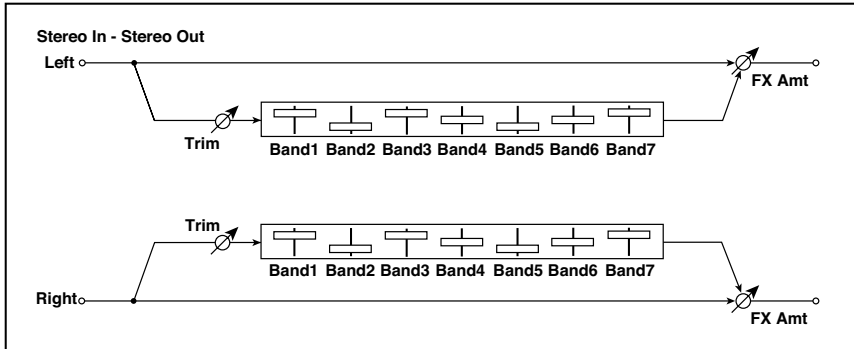

a	Type	1:Wide 1, 2:Wide 2, 3:Wide 3, 4:Half Wide 1, 5:Half Wide 2, 6:Half Wide 3, 7:Low, 8:Wide Low, 9:Mid, 10:Wide Mid, 11:High, 12:Wide High	Selects a combination of center frequencies for each band
b	Trim	0...100	Sets the input level
c	Band1 [dB]	-18.0...+18.0	Sets the gain of Band 1
d	Band2 [dB]	-18.0...+18.0	Sets the gain of Band 2
e	Band3 [dB]	-18.0...+18.0	Sets the gain of Band 3
f	Band4 [dB]	-18.0...+18.0	Sets the gain of Band 4
g	Band5 [dB]	-18.0...+18.0	Sets the gain of Band 5
h	Band6 [dB]	-18.0...+18.0	Sets the gain of Band 6
i	Band7 [dB]	-18.0...+18.0	Sets the gain of Band 7
j	Wet/Dry	Dry, 1:99...99:1, Wet	Balance between the wet and dry signal
	Src	Off...Tempo	See the list of DMS (Dynamic Modulation Sources) at the beginning of this part
	Amt	-100...+100	Amount of modulation source

■ a: Type

This parameter selects a combination of center frequencies for each band. The center frequency of each band is shown in the right of the screen.

You can configure a 21-Band Graphic EQ ranging from 80 Hz to 18 kHz if you route three Graphic 7-Band EQ effects in series, with a setting of 7:Low, 9:Mid, and 11:High for each EQ.

St.Exciter/Enhncr (Stereo Exciter/Enhancer)

This effect is a combination of the Exciter, which adds a punch to the sound and the Enhancer, which adds spread and presence.

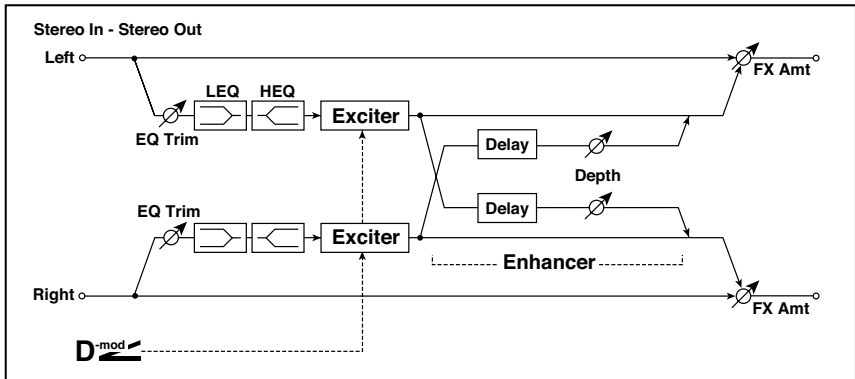

a	Exciter Blend	-100...+100	Sets the intensity (depth) of the Exciter effect
	Src	Off...Tempo	Selects the modulation source of the Exciter intensity
	Amt	-100...+100	Sets the modulation amount of the Exciter intensity
b	Emphasis Freq	0...70	Sets the frequency to be emphasized
	Src	Off...Tempo	Selects the modulation source of the frequency to be emphasized
	Amt	-70...+70	Sets the amount of modulation of the frequency to be emphasized
c	Enhancer Delay L [msec]	0.0...50.0	Sets the delay time for the Enhancer left channel
d	Enhancer Delay R [msec]	0.0...50.0	Sets the delay time for the Enhancer right channel
e	Enhancer Depth	0...100	Sets the determines to what degree the Enhancer effect is applied
	Src	Off...Tempo	Selects the modulation source of the Enhancer width
	Amt	-100...+100	Sets the modulation amount of the Enhancer width
f	EQ Trim	0...100	Sets the 2-band EQ input level
g	Pre LEQ Fc	Low, Mid-Low	Selects the cutoff frequency (low or mid-low) of the low-range equalizer
	Pre HEQ Fc	High, Mid-High	Selects the cutoff frequency (high or mid-high) of the high-range equalizer

h	Pre LEQ Gain [dB]	-15.0...+15.0	Gain of the Lo EQ
	Pre HEQ Gain [dB]	-15.0...+15.0	Gain of the High EQ
i	Wet/Dry	Dry, 1:99...99:1, Wet	Balance between the wet and dry signal
	Src	Off...Tempo	See the list of DMS (Dynamic Modulation Sources) at the beginning of this part
	Amt	-100...+100	Amount of modulation source

■ a: Exciter Blend

This parameter sets the depth (intensity) of the Exciter effect. Positive values give a frequency pattern (to be emphasized) different from negative values.

■ b: Emphasis Freq

This parameter sets the frequency to be emphasized. Higher values will emphasize lower frequencies.

■ c: Enhancer Delay L [msec]

■ d: Enhancer Delay R [msec]

These parameters set the delay time for the Enhancer left and right channel. Specifying a slightly different delay time for the left and right channel will add a stereo image, depth, and width to the sound.

Stereo Isolator

This is a stereo effect that separates the input signal into low, mid, and high-frequency bands, and controls the volume of each band independently. For example you can separately boost or cut the kick, snare, and hi-hat sounds from a drum signal in realtime.

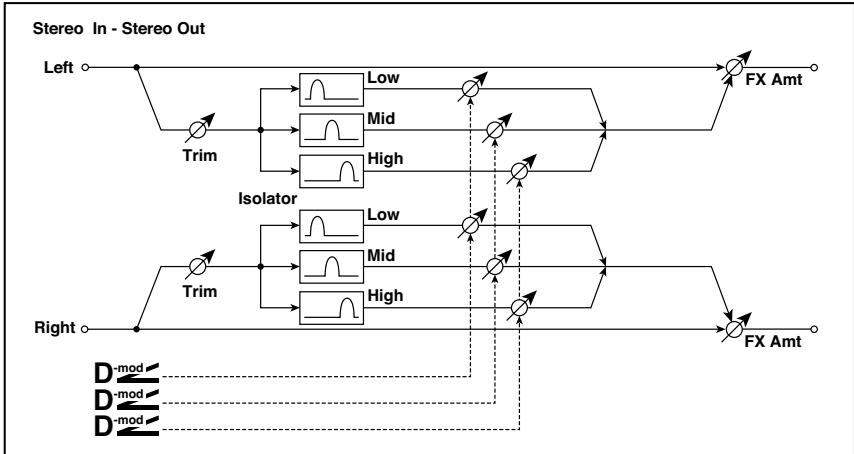



a	Trim	0...100	Sets the input level
b	Low/Mid [Hz]	100...500	Sets the frequency at which the low and mid bands are divided
c	Mid/High [Hz]	2000...6000	Sets the frequency at which the mid and high bands are divided
d	Low Gain [dB]	-Inf, -59...+12	Sets the low-frequency gain
	Src	Off...Tempo	Selects the source that will modulate low-frequency gain
	Amt	-72...+72	Sets the amount by which the low-frequency gain will be modulated
e	Mid Gain [dB]	-Inf, -59...+12	Sets the mid-frequency gain
	Src	Off...Tempo	Selects the modulation source for mid-frequency gain
	Amt	-72...+72	Sets the amount by which the mid-frequency gain will be modulated

f	High Gain [dB]	-Inf, -59...+12	Sets the high-frequency gain
	Src	Off...Tempo	Selects the modulation source for high-frequency gain
	Amt	-72...+72	Sets the amount by which the high-frequency gain will be modulated
g	Wet/Dry	Dry, 1:99...99:1, Wet	Balance between the wet and dry signal
	Src	Off...Tempo	See the list of DMS (Dynamic Modulation Sources) at the beginning of this part
	Amt	-100...+100	Amount of modulation source

Stereo Wah / Auto Wah

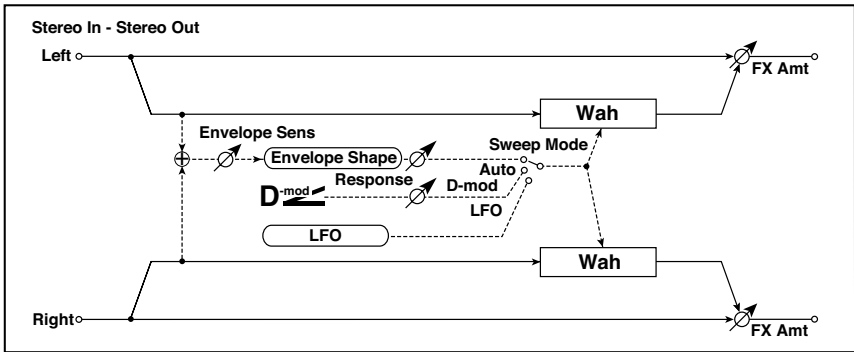
This stereo wah effect allows you to create sounds from vintage wah pedal simulation to auto-wah simulation, and much broader range settings.



a	Frequency Bottom	0...100	Sets the lower limit of the wah center frequency
	Frequency Top	0...100	Sets the upper limit of the wah center frequency
b	Sweep Mode	Auto, D-mod, LFO	Selects the control from auto-wah, modulation source, and LFO
	Src	Off...Tempo	Selects the modulation source for the wah when Sweep Mode=D-mod
	Respon	0...100	Sets the response speed when Sweep Mode = Auto or D-mod
c	Envelope Sens	0...100	Sets the sensitivity of auto-wah
	Envelope Shape	-100...+100	Sets the sweep curve of auto-wah
d	LFO Frequency [Hz]	0.02...20.00	Sets the speed of the LFO
	Src	Off...Tempo	Selects a modulation source for LFO speed
	Amt	-20.00...+20.00	Sets the modulation amount of LFO speed
e	MIDI Sync	Off, On	When this is on, the LFO speed is set by BPM, Base Note, and Times, instead of Frequency
	BPM	MIDI, 40.00...300.00	MIDI syncs to the system tempo; 40-300 sets the tempo manually for this individual effect
	Base Note		Selects the type of notes that specify the LFO speed
	Times	x1...x32	Sets the number of notes that specify the LFO speed
f	Resonance	0...100	Sets the resonance amount
	Low Pass Filter	Off, On	Switches the wah low pass filter on and off
g	Output Level	0...100	Sets the output level of the effect sound
	Src	Off...Tempo	Selects the modulation source that will control the effect output level
	Amt	-100...+100	Sets the modulation amount of the effect output level
h	Wet/Dry	Dry, 1:99...99:1, Wet	Balance between the wet and dry signal
	Src	Off...Tempo	See the list of DMS (Dynamic Modulation Sources) at the beginning of this part
	Amt	-100...+100	Amount of modulation source

- **a: Frequency Bottom**
- **a: Frequency Top**

The sweep width and direction of the wah filter are determined by the “Frequency Top” and “Frequency Bottom” settings.

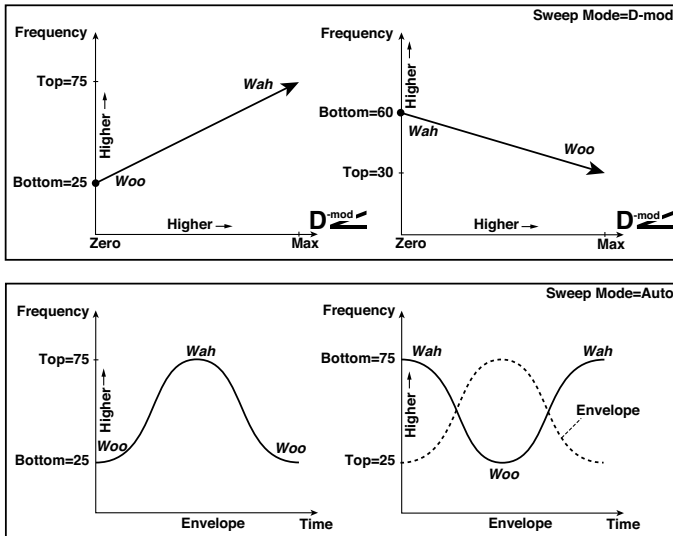

- **b: Sweep Mode**

This parameter changes the wah control mode. Setting “Sweep Mode” to Auto will select an auto-wah that sweeps according to envelope changes in the input signal level. Auto-wah is frequently used for funk guitar parts and clav sounds.

When “Sweep Mode” is set to D-mod, you can control the filter directly via the modulation source in the same way as a wah pedal.

When “Sweep Mode” is set to LFO, the effect uses LFO to sweep in cycle.

- **c: Envelope Sens**

This parameter sets the sensitivity of auto-wah. Increase the value if the input signal is too low to sweep. Reduce the value if the input signal is so high that the filter is stopped temporarily.

- **c: Envelope Shape**

This parameter determines the sweep curve for auto-wah.

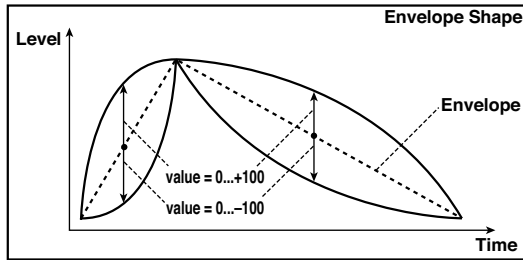

- **d: LFO Frequency [Hz]**

- **e: MIDI Sync**

When “MIDI/Tempo Sync”=Off, the LFO speed uses the LFO Frequency parameter setting. When “MIDI/Tempo Sync”=On, the LFO speed follows the “BPM”, “Base Note”, and “Times” settings.

- **e: BPM**

- **e: Base Note**

- **e: Times**

One cycle of LFO sweep is obtained by multiplying the length of a note (🎵...🎵) (selected for “Base Note”, in relation to the tempo specified in “BPM”, or the MIDI Clock tempo if “BPM” is set to MIDI) by the number specified in the Times parameter.

Stereo Vintage Wah

This effect simulates the tonal character of a vintage wah pedal. You can customize the tone and range settings.

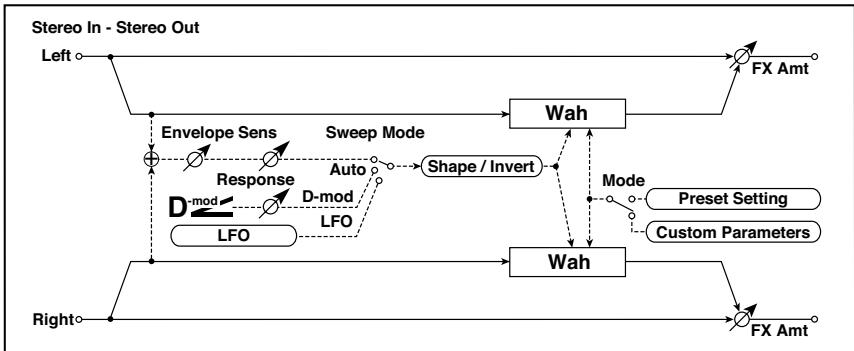

a	Mode	Preset, Custom	Selects either preset or custom settings
	Shape	-100...+100	Sets the curve of the sweep
	Invert	Off, On	Inverts the polarity of the sweep
b	Frequency Bottom	0...100	Sets the lower limit of the wah center frequency when Mode = Custom
	Frequency Top	0...100	Sets the upper limit of the wah center frequency when Mode = Custom
c	Resonance Bottom	0...100	Sets the lower limit of resonance amount when Mode=Custom
	Resonance Top	0...100	Sets the upper limit of resonance amount when Mode=Custom
d	Sweep Mode	Auto, D-mod, LFO	Selects the control from auto-wah, modulation source, and LFO
	Src	Off...Tempo	Selects the modulation source for the wah when Sweep Mode=D-mod
	Manual	0...100	Sets the center frequency when Sweep Mode=D-mod and Source=Off
e	Envelope Sens	0...100	Sets the auto-wah sensitivity
	Response	0...100	Sets the speed of response when Sweep Mode=Auto or D-mod

f	LFO Frequency [Hz]	0.02...20.00	Sets the speed of the LFO
	Src	Off...Tempo	Selects a modulation source for LFO speed
	Amt	-20.00... +20.00	Sets the modulation amount of LFO speed
g	MIDI Sync	Off, On	When this is on, the LFO speed is set by BPM, Base Note, and Times, instead of Frequency
	BPM	MIDI, 40.00... 300.00	MIDI syncs to the system tempo; 40-300 sets the tempo manually for this individual effect
	Base Note		Selects the type of notes that specify the LFO speed
	Times	x1...x32	Sets the number of notes that specify the LFO speed
h	Output Level	0...100	Sets the output level of the effect sound
	Src	Off...Tempo	Selects the modulation source that will control the effect output level
	Amt	-100...+100	Sets the modulation amount of the effect output level
i	Wet/Dry	Dry, 1:99...99:1, Wet	Balance between the wet and dry signal
	Src	Off...Tempo	See the list of DMS (Dynamic Modulation Sources) at the beginning of this part
	Amt	-100...+100	Amount of modulation source

■ a: Shape

This parameter specifies the sweep curve of the wah. It applies to all control via auto-wah, modulation source, and LFO, and lets you adjust subtle nuances of the wah effect.

■ a: Mode

■ b: Frequency Bottom

■ b: Frequency Top

■ c: Resonance Bottom

■ c: Resonance Top

If Mode=Preset, this simulates a vintage wah pedal. In this case, internally fixed values are used for Frequency Bottom/Top and Resonance Bottom/Top, and these settings will be ignored. The settings for Frequency Bottom/Top and Resonance Bottom/Top are valid if Mode=Custom.

Stereo Random Filter

This stereo band pass filter uses a step-shape waveform and random LFO for modulation. You can create a special effect from filter oscillation.

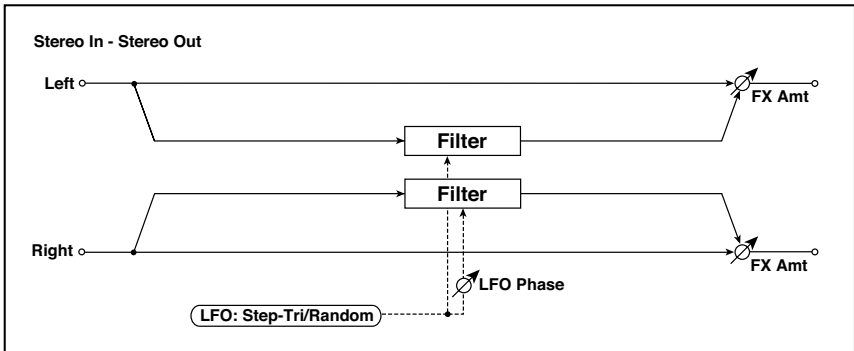

a	LFO Waveform	Step-Tri, Random	Selects the LFO Waveform
	LFO Phase [degree]	-180...+180	Sets the LFO phase difference between the left and right
b	LFO Frequency [Hz]	0.02...20.00	Sets the speed of the LFO
	Src	Off...Tempo	Selects the modulation source used for both LFO speed and step speed
	Amt	-20.00...+20.00	Sets the modulation amount of LFO speed
c	LFO Step Freq [Hz]	0.05...50.00	Sets the LFO step speed (speed that changes in steps)
	Amt	-50.00...+50.00	Sets the modulation amount of LFO step speed
d	MIDI Sync	Off, On	When this is on, the LFO speed is set by BPM, Base Note, and Times, instead of Frequency
	BPM	MIDI, 40.00...300.00	MIDI syncs to the system tempo; 40-300 sets the tempo manually for this individual effect
	Base Note		Selects the type of notes that specify the LFO speed
	Times	x1...x32	Sets the number of notes that specify the LFO speed

e	Step Base Note		Selects the type of notes to specify the LFO step speed
	Times	x1...x32	Sets the number of notes to specify the LFO step speed
f	Manual	0...100	Sets the filter center frequency
	Src	Off...Tempo	Selects the modulation source for the filter center frequency
	Amt	-100...+100	Sets the modulation amount for the filter center frequency
g	Depth	0...100	Sets the modulation depth of filter center frequency
	Src	Off...Tempo	Selects the modulation source of filter modulation
	Amt	-100...+100	Sets the modulation amount of filter modulation
h	Resonance	0...100	Sets the resonance amount
i	Wet/Dry	-Wet, -1:99... Dry...99:1, Wet	Balance between the wet and dry signal
	Src	Off...Tempo	See the list of DMS (Dynamic Modulation Sources) at the beginning of this part
	Amt	-100...+100	Amount of modulation source

■ **a: LFO Phase [degree]**

Offsetting the left and right phases alters how modulation is applied to the left and right channels, creating a swelling affect.

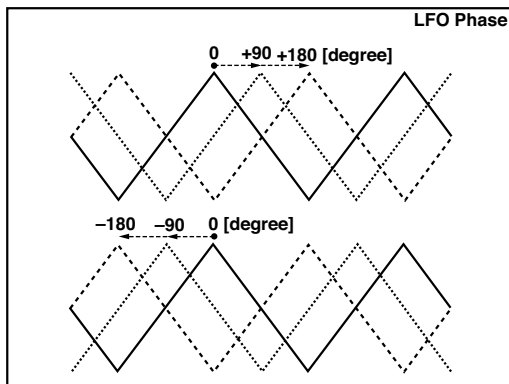

- a: LFO Waveform
- b: LFO Frequency [Hz]
- c: LFO Step Freq [Hz]

When “LFO Waveform” is set to Step-Tri, LFO is a step-shape, triangle waveform. The “LFO Frequency” parameter sets the original triangle waveform speed. Changing the “LFO Step Freq” parameter enables you to adjust the width of the steps.

When “LFO Waveform” is set to Random, the “LFO Step Freq” parameter uses a random LFO cycle.

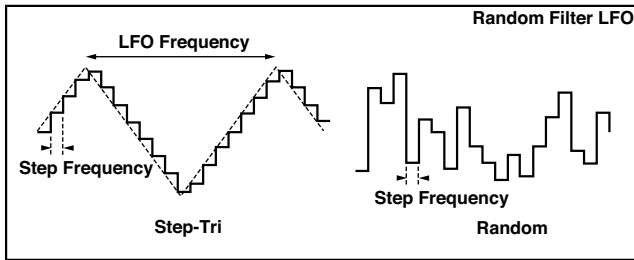

- d: BPM
- e: Step Base Note
- e: Times

The width of an LFO step, or a cycle of random LFO, is obtained by multiplying the length of a note (♩...♩) (selected for “Step Base Note”, in relation to the tempo specified in “BPM,” or the MIDI Clock tempo if “BPM” is set to MIDI) by the number specified in the “Times” parameter.

- i: Wet/Dry

The effect sound’s phase will be reversed when you set this parameter in the negative range of values.

Stereo Multi Mode Filter

This is a multi-mode filter with four types; low pass, high pass, band pass, and band reject. You can use LFO or dynamic modulation to vary the cutoff frequency or resonance.

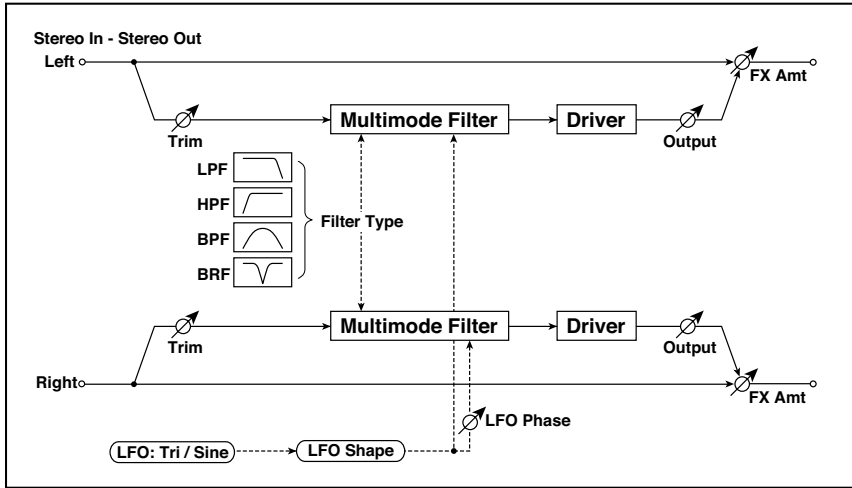



a	Type	LPF, HPF, BPF, BRF	Selects the type of filter
	Trim	0...100	Sets the input level
b	Cutoff	0...100	Sets the cutoff frequency (center frequency)
	Src	Off...Tempo	Selects the modulation source of the cutoff
	Amt	-100...+100	Sets the modulation amount of the cutoff
c	Resonance	0...100	Sets the resonance amount
	Src	Off...Tempo	Selects the source that will modulate the amount of resonance
	Amt	-100...+100	Sets the amount by which the resonance will be modulated
d	LFO Waveform	Triangle, Sine	Selects the LFO Waveform
	Phase [degree]	-180...+180	Sets the LFO phase difference between the left and right
	Depth	0...100	Sets the depth to which the LFO will modulate the cutoff frequency

e	LFO Frequency [Hz]	0.02...20.00	Sets the speed of the LFO
	Src	Off...Tempo	Selects a modulation source for LFO speed
	Amt	-20.00... +20.00	Sets the modulation amount of LFO speed
f	MIDI Sync	Off, On	When this is on, the LFO speed is set by BPM, Base Note, and Times, instead of Frequency
	BPM	MIDI, 40.00... 300.00	MIDI syncs to the system tempo; 40–300 sets the tempo manually for this individual effect
	Base Note		Selects the type of notes that specify the LFO speed
	Times	x1...x32	Sets the number of notes that specify the LFO speed
g	Drive SW	Off, On	Switches distortion on/off within the filter
	Output Level	0...100	Sets the output level
h	Drive Gain	0...100	Sets the distortion amount
	Low Boost	0...100	Sets the amount of low-range boost
i	Wet/Dry	Dry, 1:99...99:1, Wet	Balance between the wet and dry signal
	Src	Off...Tempo	See the list of DMS (Dynamic Modulation Sources) at the beginning of this part
	Amt	-100...+100	Amount of modulation source

Talking Modulator

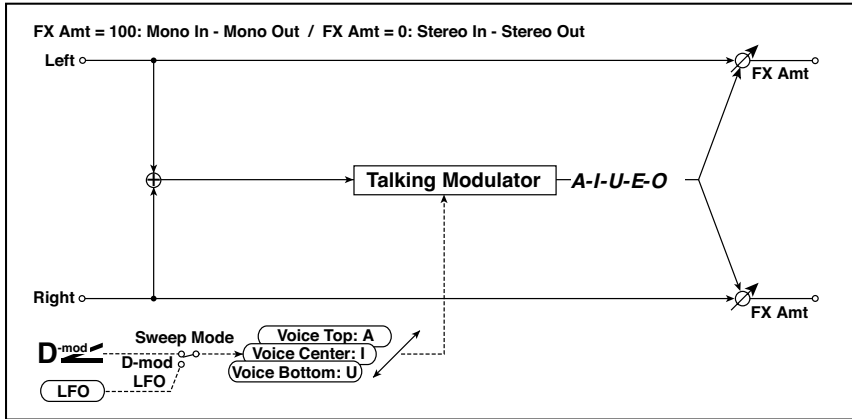
This effect adds an unusual character, like a human voice, to the input signal. Modulating the tone via dynamic modulation, you can create an interesting effect that sounds as if the guitar or synthesizer is talking.



a	Sweep Mode	D-mod, LFO	Switches between modulation source control and LFO control
b	Manual Voice Control	Bottom, 1...49, Center, 51...99, Top	Voice pattern control
	Src	Off...Tempo	Selects the modulation source that controls the voice pattern
c	Voice Top	A, I, U, E, O	Selects a vowel sound at the top end of control
d	Voice Center	A, I, U, E, O	Selects a vowel sound in the center of control
e	Voice Bottom	A, I, U, E, O	Selects a vowel sound at the bottom end of control
f	Formant Shift	-100...+100	Sets the frequency to which the effect is applied
	Resonance	0...100	Sets the Level of resonance of the voice pattern
g	LFO Frequency [Hz]	0.02...20.00	Sets the speed of the LFO
	Src	Off...Tempo	Selects a modulation source for LFO speed
	Amt	-20.00...+20.00	Sets the modulation amount of LFO speed
h	MIDI Sync	Off, On	When this is on, the LFO speed is set by BPM, Base Note, and Times, instead of Frequency
	BPM	MIDI, 40.00...300.00	MIDI syncs to the system tempo; 40-300 sets the tempo manually for this individual effect
	Base Note		Selects the type of notes that specify the LFO speed
	Times	x1...x32	Sets the number of notes that specify the LFO speed
i	Wet/Dry	Dry, 1:99...99:1, Wet	Balance between the wet and dry signal
	Src	Off...Tempo	See the list of DMS (Dynamic Modulation Sources) at the beginning of this part
	Amt	-100...+100	Amount of modulation source

- **c: Voice Top**

- **d: Voice Center**

- **e: Voice Bottom**

These parameters assign vowels to the top, center, and bottom position of the controller.

For example, when “Voice Top”=A, “Voice Center”=I, and “Voice Bottom”=U:

If “Sweep Mode” is set to D-mod and Ribbon is selected as the modulation source, moving your finger from the right to left of the ribbon controller will change the sound from “a” to “i,” then “u.”

If Sweep Mode is set to LFO, the sound will change cyclically from “a” to “i,” “u,” “i,” then “a.”

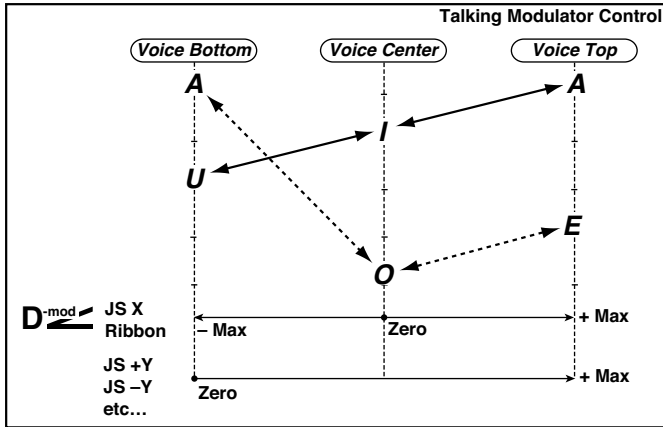

■ **f: Formant Shift**

This parameter adjusts the frequency level to which the effect is applied. If you wish to apply the effect to a higher-range sound, set this parameter to a higher value; to apply the effect to a lower-range sound, set this to a lower value.

■ **f: Resonance**

This parameter sets the intensity of resonance for the voice pattern. A larger value will add more character to the sound.

2 Voice Resonator

This effect resonates the input signal at a specified pitch. You can set the pitch, output level, and pan settings for two resonators individually. You can control the resonance intensity via an LFO.

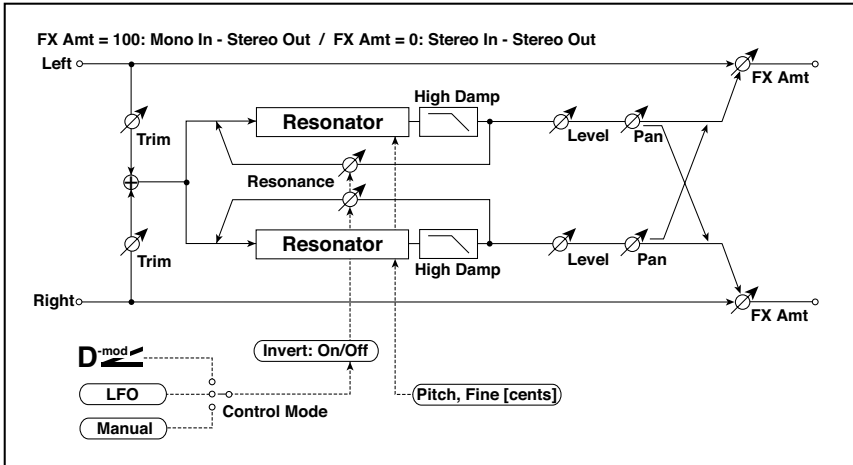

a	Control Mode	Manual, LFO, D-mod	Switches the controls of resonance intensity
	LFO/D-mod Invert	Off, On	Reverses the Voice 1 and 2 control when LFO/D-mod is selected
b	LFO Frequency [Hz]	0.02...20.00	Sets the speed of the LFO
	D-mod Src	Off...Tempo	Selects the modulation source that controls resonance intensity
c	MIDI Sync	Off, On	When this is on, the LFO speed is set by BPM, Base Note, and Times, instead of Frequency
	BPM	MIDI, 40.00...300.00	MIDI syncs to the system tempo; 40–300 sets the tempo manually for this individual effect
	Base Note		Selects the type of notes that specify the LFO speed
	Times	x1...x32	Sets the number of notes that specify the LFO speed
d	Mod. Depth	-100...+100	Sets the amount of resonance intensity control via LFO/D-mod
	Trim	0...100	Sets the input level at the resonator
e	Voice1: Pitch	C0...B8	Sets the voice1 Pitch for resonance
	Fine [cents]	-50...+50	Fine-adjusts the voice 1 pitch for resonance
	Level	0...100	Sets the Voice1 output level

f	Voice1: Resonance	-100...+100	Sets the intensity of resonance when Control Mode = Manual
	High Damp [%]	0...100	Sets the damping amount of resonant sound in the high range
	Pan	L6...L1, C, R1...R6	Sets the Voice1 stereo image
g	Voice2: Pitch	C0...B8	Sets the voice 2 Pitch for resonance
	Fine [cents]	-50...+50	Fine-adjusts the voice 2 pitch for resonance
	Level	0...100	Sets the Voice2 output level
h	Voice2: Resonance	-100...+100	Sets the intensity of resonance when Control Mode = Manual
	High Damp [%]	0...100	Sets the damping amount of resonant sound in the high range
	Pan	L6...L1, C, R1...R6	Sets the Voice2 stereo image
i	Wet/Dry	Dry, 1:99...99:1, Wet	Balance between the wet and dry signal
	Src	Off...Tempo	See the list of DMS (Dynamic Modulation Sources) at the beginning of this part
	Amt	-100...+100	Amount of modulation source

- **a: Control Mode**
- **f: Voice 1: Resonance**
- **h: Voice 2: Resonance**

This parameter determines the resonance intensity.

When “Control Mode” = Manual, the “Resonance” parameter sets the intensity of resonance. If the “Resonance” parameter has a negative value, harmonics will be changed, and resonance will occur at a pitch one octave lower.

When “Control Mode” = LFO, the intensity of resonance varies according to the LFO. The LFO sways between positive and negative values, causing resonance to occur between specified pitches an octave apart in turn.

When “Control Mode” = D-mod, the resonance is controlled by the dynamic modulation source. If JS X or Ribbon is assigned as the modulation source, the pitch an octave higher and lower can be controlled, similar to when LFO is selected for Control Mode.

- **a: LFO/D-mod Invert**

When “Control Mode” = LFO or D-mod, the controlled phase of either Voice 1 or 2 will be reversed. When the resonance pitch is set for Voice 1 (Resonance has a positive value), Voice 2 will resonate at a pitch an octave below (Resonance has a negative value).

- **f: Voice 1: Pitch**

- **f: Fine [cents]**

- **h: Voice 2: Pitch**

- **h: Fine [cents]**

The Pitch parameter specifies the pitch of resonance by note name. The “Fine” parameter allows for fine adjustment in steps of cents.

- **g: High Damp [%]**

- **i: High Damp [%]**

This sets the amount of damping amount for the high frequencies of the resonant sound. Lower values create a metallic sound with a higher range of harmonics.

P4EQ + Exciter

This effect combines a mono four-band parametric equalizer and an exciter.

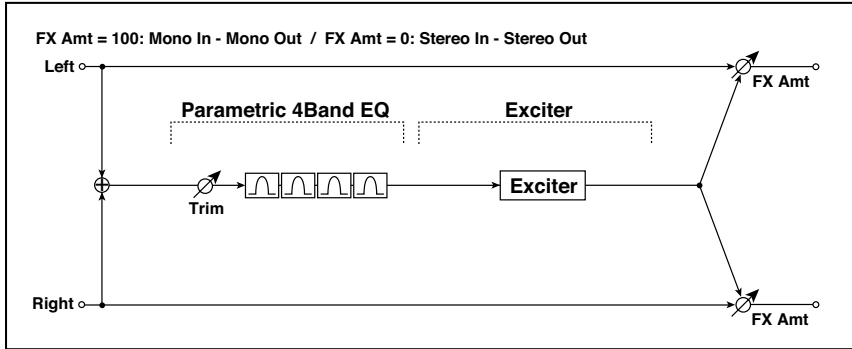

P4EQ

a	[E]Trim	0...100	Sets the parametric EQ input level
b	[E]B1 Cutoff [Hz]	20...1.00k	Sets the center frequency of Band 1
	Q	0.5...10.0	Sets the bandwidth of Band 1
	Gain [dB]	-18...+18	Sets the gain of Band 1
c	[E]B2 Cutoff [Hz]	50...5.00k	Sets the center frequency of Band 2
	Q	0.5...10.0	Sets the bandwidth of Band 2
	Gain [dB]	-18...+18	Sets the gain of Band 2
d	[E]B3 Cutoff [Hz]	300...10.00k	Sets the center frequency of Band 3
	Q	0.5...10.0	Sets the bandwidth of Band 3
	Gain [dB]	-18...+18	Sets the gain of Band 3
e	[E]B4 Cutoff [Hz]	500...20.00k	Sets the center frequency of Band 4
	Q	0.5...10.0	Sets the bandwidth of Band 4
	Gain [dB]	-18...+18	Sets the gain of Band 4

EXCITER

f	[X]Exciter Blend	-100...+100	Sets the intensity (depth) of the Exciter effect
g	[X]Emphasis Freq	0...70	Sets the frequency range to be emphasized
h	Wet/Dry	Dry, 1:99...99:1, Wet	Balance between the wet and dry signal
	Src	Off...Tempo	See the list of DMS (Dynamic Modulation Sources) at the beginning of this part
	Amt	-100...+100	Amount of modulation source

P4EQ + Wah

This effect combines a mono four-band parametric equalizer and a wah. You can change the order of the connection.

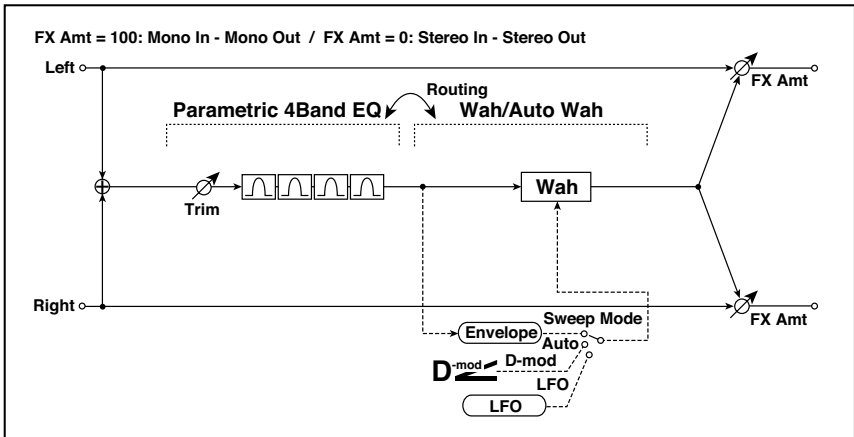

P4EQ

a	[E]Trim	0...100	Sets the parametric EQ input level
	Routing	P4EQ > Wah, Wah > P4EQ	Changes the order of the parametric equalizer and wah connection
b	[E]B1 Cutoff [Hz]	20...1.00k	Sets the center frequency of Band 1
	Q	0.5...10.0	Sets the bandwidth of Band 1
	Gain [dB]	-18...+18	Sets the gain of Band 1
c	[E]B2 Cutoff [Hz]	50...5.00k	Sets the center frequency of Band 2
	Q	0.5...10.0	Sets the bandwidth of Band 2
	Gain [dB]	-18...+18	Sets the gain of Band 2
d	[E]B3 Cutoff [Hz]	300...10.00k	Sets the center frequency of Band 3
	Q	0.5...10.0	Sets the bandwidth of Band 3
	Gain [dB]	-18...+18	Sets the gain of Band 3
e	[E]B4 Cutoff [Hz]	500...20.00k	Sets the center frequency of Band 4
	Q	0.5...10.0	Sets the bandwidth of Band 4
	Gain [dB]	-18...+18	Sets the gain of Band 4

WAH

f	[W]Frequency Bottom	0...100	Sets the lower limit of the wah center frequency
	Frequency Top	0...100	Sets the upper limit of the wah center frequency

g	[W]Sweep Mode	Auto, D-mod, LFO	Selects the control from auto-wah, modulation source, and LFO
	Src	Off...Tempo	Selects the modulation source for the wah when Sweep Mode=D-mod
h	[W]LFO Frequency [Hz]	0.02...20.00	Sets the speed of the LFO
	Resonance	0...100	Sets the resonance amount
	LPF	Off, On	Switches the wah low pass filter on and off
i	[W] Wet/Dry	Dry,1 : 99... 99 : 1, Wet	Sets the wah effect balance
	Src	Off...Tempo	Selects the Wet/Dry modulation source for the wah
	Amt	-100...+100	Sets the Wet/Dry modulation amount for the wah
j	Wet/Dry	Dry, 1:99...99:1, Wet	Balance between the wet and dry signal
	Src	Off...Tempo	See the list of DMS (Dynamic Modulation Sources) at the beginning of this part
	Amt	-100...+100	Amount of modulation source

Vocoder

This effect applies the timbral character of a different signal (the modulator) to the input signal (the carrier).

A common use of this effect is to produce the sound of various instruments by inputting a voice to the Modulator via a microphone. A special effect is also achieved by using rhythm or effect sounds. Strings or distortion guitar sounds with a lot of harmonics are suitable as Carrier signals.

When this effect is selected, the microphone input no longer goes to the Voice Processor, but is routed to this FX processor.

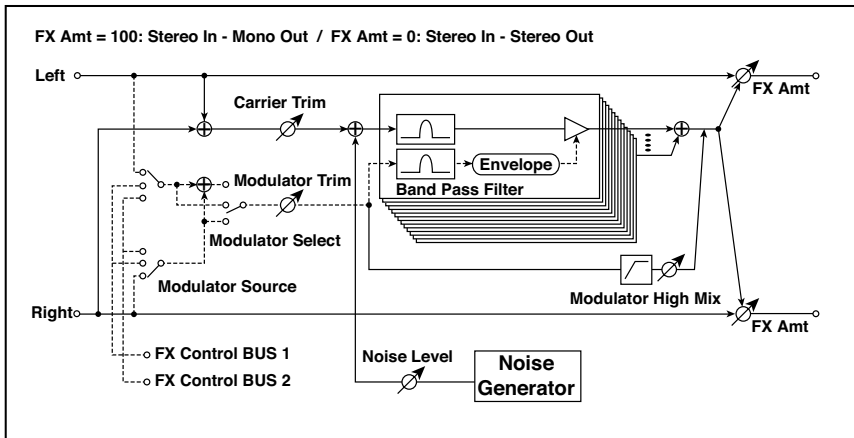

a	Carrier Trim	0...100	Sets the carrier input level
b	Modulator Trim	0...100	Sets the modulator input level
c	Modulator Source	Input, FX Control 1, FX Control 2	Choose either FX Control 1 or 2 to select the microphone input as the modulator. Choose FX Control 1 for the Left Line input, or FX Control 2 for the Right Line input. Choose Input to use the Sound as the modulator. If you want to use the keyboard as the modulator, apply the Vocoder effect to one of the Upper Sounds.
d	Modulator Select	L/R Mix, L Only, R Only	Selects whether to use the left/right mix, only left, or only right of the modulator input
e	Formant Shift	-2...+2	Sets the height of the frequency for the vocoder effect
f	Response	0...100	Sets the speed of the response to the modulator input

g	Noise Level	0...100	Sets the noise mix level to the Carrier
	Src	Off...Tempo	Selects the modulation source for the noise mix level
	Amt	-100...+100	Sets the modulation amount for the noise mix level
h	Modulator High Mix	0...100	Sets the high-range output level of the modulator
	Low Gain [dB]	-12...+12	Sets the low-range output level of the vocoder
i	High Gain [dB]	-12...+12	Sets the high-range output level of the vocoder
	Wet/Dry	Dry, 1:99...99:1, Wet	Balance between the wet and dry signal
j	Src	Off...Tempo	See the list of DMS (Dynamic Modulation Sources) at the beginning of this part
	Amt	-100...+100	Amount of modulation source

■ e: Formant Shift

By offsetting the Carrier filter, you can adjust the height of the frequency range to which the vocoder effect is applied. The tonal quality will change significantly.

■ g: Noise Level

This parameter enables you to mix white noise with the Carrier.

■ h: Modulator High Mix

This parameter sets the high-range output level of the modulator sound. If the modulator is a human voice, it will make the words more clear.

■ Using the vocoder with the microphone input

When programming the Vocoder, you can start from one of the specially programmed **Vocoder** Keyboard Sets (in the **Synth** group) as templates.

To use a voice from a microphone as a modulator:

- 1 Turn the microphone channel off (you can use **BUTTON #1** while in the **MAIN** mode of the **CONTROL** section).
- 2 Connect a microphone to the **MIC** audio input.
- 3 Set **Modulator Source** to **FX Control 1**.
- 4 Speak into the microphone while you use the **GAIN** knob (next to the **MIC** input) to adjust the level as high as possible without allowing distortion to occur.

With these settings, the sound from the microphone will be used as the modulator. While you play, speak into the mic; it will sound as though the instrument is talking.

If the effect sound is distorted, adjust the **Carrier Trim** and **Modulator Trim**.

Please remember to set the Carrier track's **Dry** parameter to Off, and the Send value to 127.

You can add reverb to the Vocoder, by way of the **to MFX1** parameter.

VOX Wah

This effect is modeled on two legendary VOX wah pedals: the V847 and the V848 Clyde McCoy model. Thanks to their unique ‘throaty’ tone, these are the only wah pedals that many professionals will consider putting under their feet. Played musically, they can make your melody lines cry like a baby—or howl like a man possessed!

A great tonal trick is to find a ‘sweet spot’ within the range of the Wah pedal and then leave it there. This ‘stuck-Wah’ can be very effective when used tastefully, producing a distinctive sound that will cut through any mix.

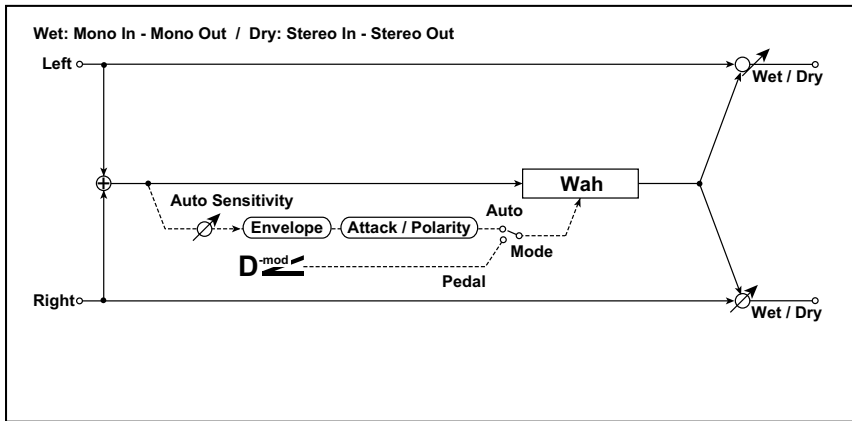

a	Type	V847, V848	Effect model
b	Open	0...99	Level when open
	Close	0...99	Level when close
c	Mode	Auto, Pedal	Selects either auto or pedal mode
d	Pedal Source	Off...Tempo	Selects the modulation source when in pedal mode
	Pedal Manual	0...99	Level when in pedal mode
e	Auto Sensivity	0...100	Sensitivity when in auto mode
	Auto Polarity	Up, Down	Polarity when in auto mode
	Auto Attack	0...99	Attack time

f	Wet/Dry	Dry, 1:99...99:1, Wet	Balance between the wet and dry signal
	Src	Off...Tempo	See the list of DMS (Dynamic Modulation Sources) at the beginning of this part
	Amt	-100...+100	Amount of modulation source

VOX Treble Booster

Vintage booster of high frequencies.

a	Drive	0...99	Amount of the boost effect
b	Level	0...99	General level
c	Tone	0...100	Tone of the effect
d	Wet/Dry	Dry, 1:99...99:1, Wet	Balance between the wet and dry signal
	Src	Off...Tempo	See the list of DMS (Dynamic Modulation Sources) at the beginning of this part
	Amt	-100...+100	Amount of modulation source

Frequency

Stereo Sub Oscillator

This effect adds very low frequencies to the input signal. It is very useful when simulating a roaring drum sound or emphasizing powerful low range. This effect is different from the equalizer in that you can add very low range harmonics. You can also adjust the oscillator frequency to match a particular note number, for use as an octaver.

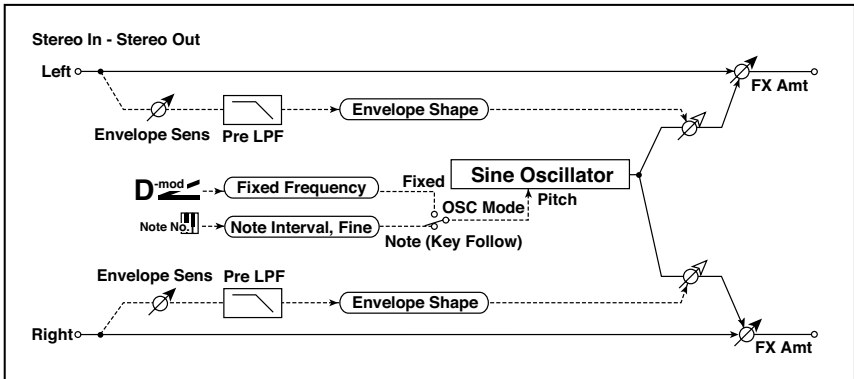

a	OSC Mode	Note (Key Follow), Fixed	Determines whether the oscillator frequency follows the note number or whether it is fixed
b	Note Interval	-48...0	Sets the pitch difference from the note number when OSC Mode=Note (Key Follow)
	Note Fine	-100...+100	Fine adjustment of the oscillator frequency
c	Fixed Frequency [Hz]	10.0...80.0	Sets the oscillator frequency when OSC Mode=Fixed
	Src	Off...Tempo	Selects the modulation source for the oscillator frequency when OSC Mode=Fixed
	Amt	-80...+80	Sets the oscillator frequency modulation amount when OSC Mode=Fixed
d	Envelope Pre LPF	1...100	Sets the upper limit of the frequency range for which very low harmonics are added
e	Envelope Sens	0...100	Sets the sensitivity with which very low harmonics are added
	Envelope Shape	-100...+100	Sets the oscillator's volume envelope curve

f	Wet/Dry	Dry, 1:99...99:1, Wet	Balance between the wet and dry signal
	Src	Off...Tempo	See the list of DMS (Dynamic Modulation Sources) at the beginning of this part
	Amt	-100...+100	Amount of modulation source

- **a: OSC Mode**

- **b: Note Interval**

- **b: Note Fine**

The “OSC Mode” parameter selects the oscillator operation mode. When Note (Key Follow) is selected, the oscillator’s frequency is determined based on the note number, allowing you to use it as an octaver. The “Note Interval” parameter sets the pitch offset from the original note number by semitone steps. The “Note Fine” parameter allows you to fine-tune in steps of cents.

- **d: Envelope Pre LPF**

This parameter sets the upper limit of the frequency range to which very low harmonics are added. Adjust this parameter if you do not want to add lower harmonics to the higher range.

Grain Shifter

This effect cuts extremely short samples ('grains') from the input signal waveform and plays them repeatedly, giving a mechanical character to the sound.

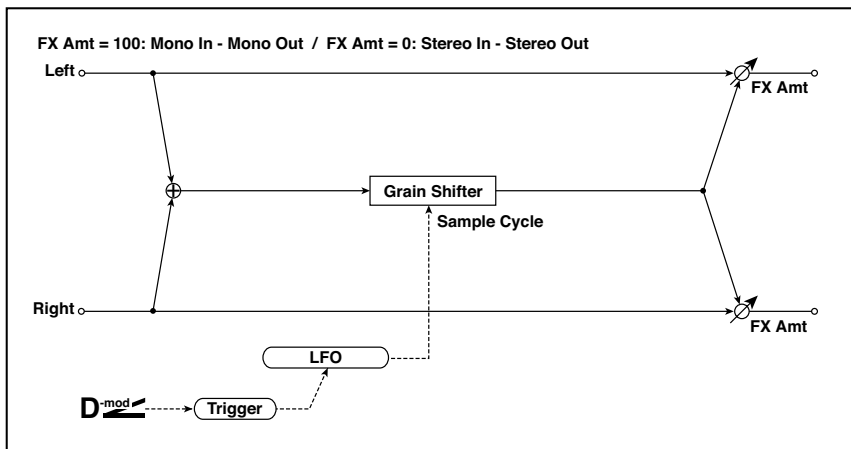

a	Duration	0...100	Sets the duration of the grain
	Src	Off...Tempo	Selects the source that will modulate the duration of the grain
	Amt	-100...+100	Sets the amount by which the grain duration will be modulated
b	LFO Sync Src	Off...Tempo	Selects the modulation source that will reset the LFO
c	LFO Sample Cycle [Hz]	0.02...20.00	Sets the frequency at which the grain will be switched
	Src	Off...Tempo	Selects a modulation source for LFO speed
	Amt	-20.00...+20.00	Sets the modulation amount of LFO speed
d	MIDI Sync	Off, On	When this is on, the LFO speed is set by BPM, Base Note, and Times, instead of Frequency
	BPM	MIDI, 40.00...300.00	MIDI syncs to the system tempo; 40-300 sets the tempo manually for this individual effect
	Base Note		Selects the type of notes that specify the LFO speed
	Times	x1...x32	Sets the number of notes that specify the LFO speed

e	Wet/Dry	Dry, 1:99...99:1, Wet	Balance between the wet and dry signal
	Src	Off...Tempo	See the list of DMS (Dynamic Modulation Sources) at the beginning of this part
	Amt	-100...+100	Amount of modulation source

- **a: Duration**
- **c: LFO Sample Cycle [Hz]**

Duration sets the length of the sampled grain, and the LFO **Sample Cycle** controls how often a new grain is sampled. In between Sample Cycles, the current grain is repeated continuously.

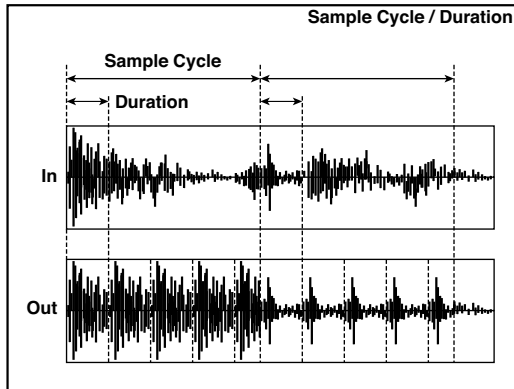

Detune

Using this effect, you can obtain a detune effect that offsets the pitch of the effect sound slightly from the pitch of the input signal. Compared to the chorus effect, a more natural sound thickness will be created.

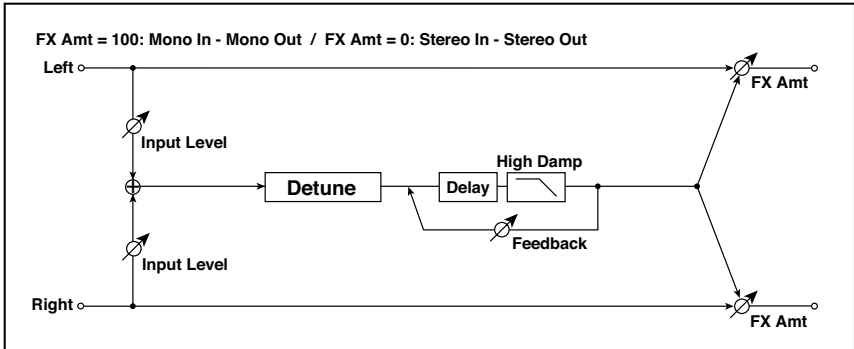

a	Pitch Shift [cents]	-100...+100	Sets the pitch difference from the input signal
	Src	Off...Tempo	Selects a modulation source for pitch shift
	Amt	-100...+100	Sets the modulation amount for pitch shift
b	Delay Time [msec]	0...1000	Sets the delay time
c	Feedback	-100...+100	Sets the feedback amount
	High Damp [%]	0...100	Sets the damping amount in the high range
d	Input Level Dmod [%]	-100...+100	Sets the modulation amount of the input level
	Src	Off...Tempo	Selects the modulation source for the input level
e	Wet/Dry	Dry, 1:99...99:1, Wet	Balance between the wet and dry signal
	Src	Off...Tempo	See the list of DMS (Dynamic Modulation Sources) at the beginning of this part
	Amt	-100...+100	Amount of modulation source

- **d: Input Level Dmod [%]**
- **d: Src**

This parameter sets the dynamic modulation of the input level.

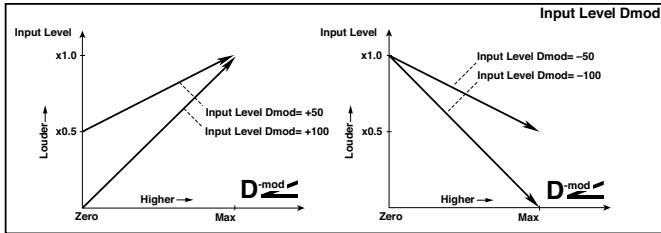

Pitch Shifter

This effect changes the pitch of the input signal. You can select from three types: Fast (quick response), Medium, and Slow (preserves tonal quality). You can also create an effect in which the pitch is gradually raised (or dropped) using the delay with feedback.

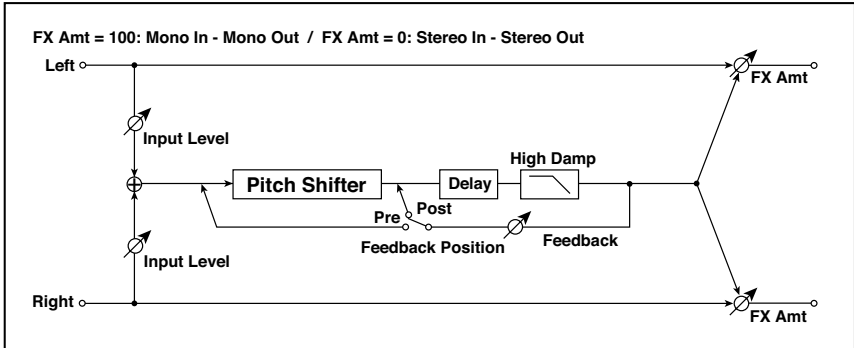

a	Mode	Slow, Medium, Fast	Switches Pitch Shifter mode
b	Pitch Shift [1/2tone]	-24...+24	Sets the pitch shift amount by steps of a semitone
	Src	Off...Tempo	Selects the modulation source of pitch shift amount
	Amt	-24...+24	Sets the modulation amount of pitch shift amount
c	Fine [cents]	-100...+100	Sets the pitch shift amount by steps of a cent
	Amt	-100...+100	Sets the modulation amount of pitch shift amount
d	Delay Time [msec]	0...2000	Sets the delay time
e	Feedback Position	Pre, Post	Switches the feedback connection
f	Feedback	-100...+100	Sets the feedback amount
	High Damp [%]	0...100	Sets the damping amount in the high range
g	Input Level Dmod [%]	-100...+100	Sets the modulation amount of the input level
	Src	Off...Tempo	Selects the modulation source for the input level

h	Wet/Dry	Dry, 1:99...99:1, Wet	Balance between the wet and dry signal
	Src	Off...Tempo	See the list of DMS (Dynamic Modulation Sources) at the beginning of this part
	Amt	-100...+100	Amount of modulation source

■ a: Mode

This parameter switches the pitch shifter operating mode. With Slow, tonal quality will not be changed too much. With Fast, the effect becomes a Pitch Shifter that has a quick response, but may change the tone. Medium is in-between these two. If you do not need to set too much pitch shift amount, set this parameter to Slow. If you wish to change the pitch significantly, use Fast.

■ b: Pitch Shift [1/2tone]

■ b: Src

■ b: Amt

■ c: Fine [cents]

■ c: Amt

The amount of pitch shift will use the value of the **Pitch Shift** plus the **Fine** value. The amount of modulation will use the b: Amt value plus the c: Amt.

The same Modulation Source is used for both **Pitch Shift** and **Fine**.

■ e: Feedback Position

■ f: Feedback

When **Feedback Position** is set to **Pre**, the pitch shifter output is again input to the pitch shifter. Therefore, if you specify a higher value for the **Feedback** parameter, the pitch will be raised (or lowered) more and more each time feedback is repeated.

If **Feedback Position** is set to **Post**, the feedback signal will not pass through the pitch shifter again. Even if you specify a higher value for the **Feedback** parameter, the pitch-shifted sound will be repeated at the same pitch.

Pitch Shifter BPM

This pitch shifter enables you to set the delay time to match the song tempo.

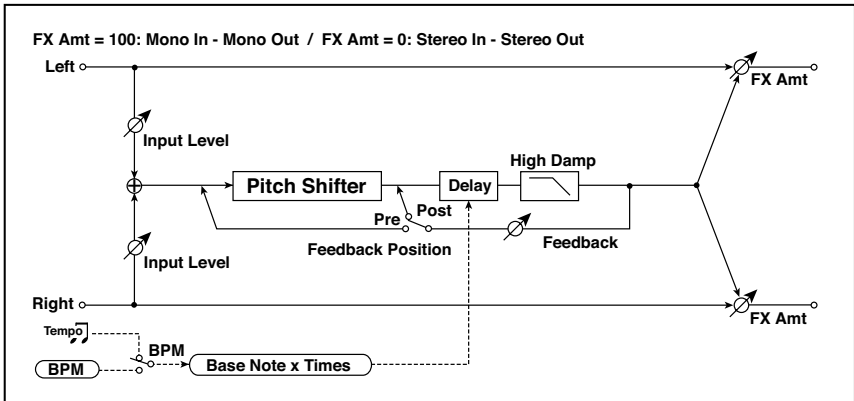

a	Mode	Slow, Medium, Fast	Switches Pitch Shifter mode
b	Pitch Shift [1/2tone]	-24...+24	Sets the pitch shift amount in steps of a semitone
	Src	Off...Tempo	Selects the modulation source of pitch shift amount
	Amt	-24...+24	Sets the modulation amount of pitch shift amount
c	Fine [cents]	-100...+100	Sets the pitch shift amount in steps of one cent
	Amt	-100...+100	Sets the modulation amount of pitch shift amount
d	BPM	MIDI, 40.00... 300.00	MIDI syncs to the system tempo; 40-300 sets the tempo manually for this individual effect
	Time Over?	---, OVER!	Displays an error message when the delay time exceeds the upper limit
e	Delay Base Note	 ...	Selects the type of notes to specify the delay time
	Times	x1...x32	Sets the number of notes to specify the delay time
f	Feedback Position	Pre, Post	Switches the feedback connection
g	Feedback	-100...+100	Sets the feedback amount
	High Damp [%]	0...100	Sets the damping amount in the high range

h	Input Level Dmod [%]	-100...+100	Sets the modulation amount of the input level
	Src	Off...Tempo	Selects the modulation source for the input level
i	Wet/Dry	Dry, 1:99...99:1, Wet	Balance between the wet and dry signal
	Src	Off...Tempo	See the list of DMS (Dynamic Modulation Sources) at the beginning of this part
	Amt	-100...+100	Amount of modulation source

- **d: BPM**

- **e: Delay Base Note**

- **e: Times**

The delay time is the duration of “Times” number of “Delay Base Note” note values at the “BPM” tempo (or if “BPM” is set to MIDI, the tempo determined by MIDI Clock).

- **d: Time Over?**

You can set the delay time up to 5,290msec. If the delay time exceeds this limit, the error message “OVER!” appears on the display. Set the delay time parameters so that this message will not appear. “Time Over?” is only a display parameter.

Pitch Shift Mod

This effect modulates the detuned pitch shift amount using an LFO, adding a clear spread and width to the sound by panning the effect sound and dry sound to the left and right. This is especially effective when the effect sound and dry sound output from stereo speakers are mixed.

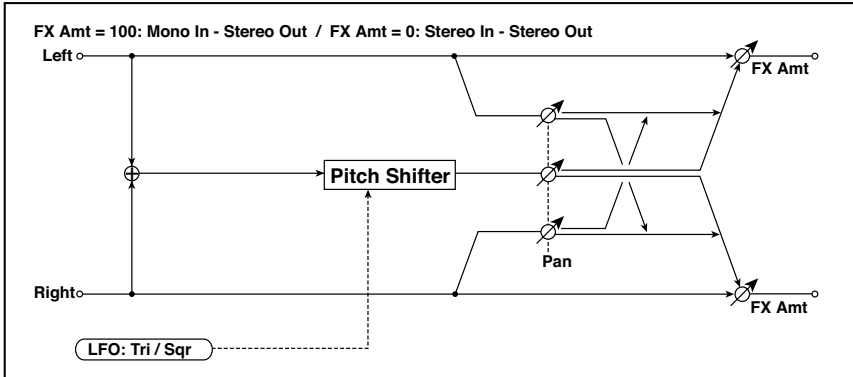

a	Pitch Shift [cents]	-100...+100	Sets the pitch difference from the input signal
b	LFO Waveform	Triangle, Square	Selects the LFO Waveform
c	LFO Frequency [Hz]	0.02...20.00	Sets the speed of the LFO
	Src	Off...Tempo	Selects a modulation source for LFO speed
	Amt	-20.00...+20.00	Sets the modulation amount of LFO speed
d	MIDI Sync	Off, On	When this is on, the LFO speed is set by BPM, Base Note, and Times, instead of Frequency
	BPM	MIDI, 40.00...300.00	MIDI syncs to the system tempo; 40-300 sets the tempo manually for this individual effect
	Base Note		Selects the type of notes that specify the LFO speed
	Times	x1...x32	Sets the number of notes that specify the LFO speed
e	Depth	-100...+100	Sets the LFO modulation depth for pitch shift amount
	Src	Off...Tempo	Selects the modulation source of the depth of modulation
	Amt	-100...+100	Sets the modulation amount of the depth of modulation
f	Pan	L, 1:99...99:1, R	Sets the panning effect sound and dry sound separately

g	Wet/Dry	Dry, 1:99...99:1, Wet	Balance between the wet and dry signal
	Src	Off...Tempo	See the list of DMS (Dynamic Modulation Sources) at the beginning of this part
	Amt	-100...+100	Amount of modulation source

■ **a: Pitch Shift [cents]**

■ **e: Depth**

These parameters set the amount of pitch shift and amount of modulation by means of the LFO.

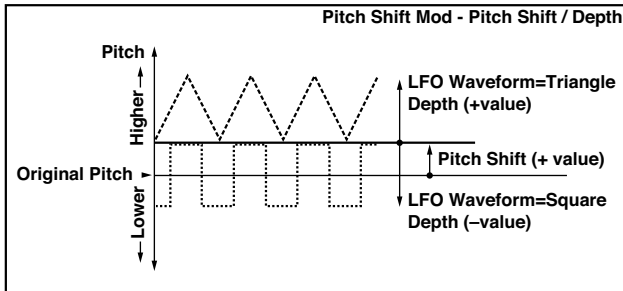

■ **g: Pan**

■ **h: Wet/Dry**

The Pan parameter pans the effect sound and dry sound to the left and right. With L, the effect sound is panned left, and the dry sound is panned right. With a Wet/Dry = Wet setting, the effect and dry sound will be output in a proportion of 1:1.

Stereo Pitch Shifter

This is a stereo pitch shifter. The pitch shift amount for the left and right channels can be reversed from each other.

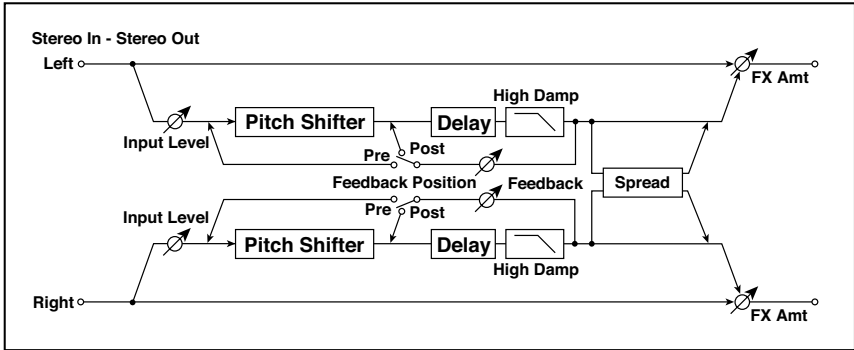

a	Mode	Slow, Medium, Fast	Switches Pitch Shifter mode
	L/R Pitch	Normal, Up/Down	Determines whether or not the L/R pitch shift amount is inverted
b	Pitch Shift [1/2tone]	-24...+24	Sets the pitch shift amount in steps of a semitone
	Src	Off...Tempo	Selects the modulation source of pitch shift amount
	Amt	-24...+24	Sets the modulation amount of pitch shift amount
c	Fine [cents]	-100...+100	Sets the pitch shift amount in steps of one cent
	Amt	-100...+100	Sets the modulation amount of pitch shift amount
d	L Delay [msec]	0...2000	Sets the delay time for the left channel
e	R Delay [msec]	0...2000	Sets the delay time for the right channel
f	Feedback	-100...+100	Sets the feedback amount
	High Damp [%]	0...100	Sets the damping amount in the high range
g	Feedback Position	Pre, Post	Switches the feedback connection
	Spread	-100...+100	Sets the width of the stereo image of the effect sound
h	Input Level Dmod [%]	-100...+100	Sets the modulation amount of the input level
	Src	Off...Tempo	Selects the modulation source for the input level

i	Wet/Dry	Dry, 1:99...99:1, Wet	Balance between the wet and dry signal
	Src	Off...Tempo	See the list of DMS (Dynamic Modulation Sources) at the beginning of this part
	Amt	-100...+100	Amount of modulation source

■ a: L/R Pitch



When you select Up/Down for this parameter, the pitch shift amount for the right channel will be reversed. If the pitch shift amount is positive, the pitch of the left channel is raised, and the pitch of the right channel is lowered.

Stereo Pitch Shifter BPM

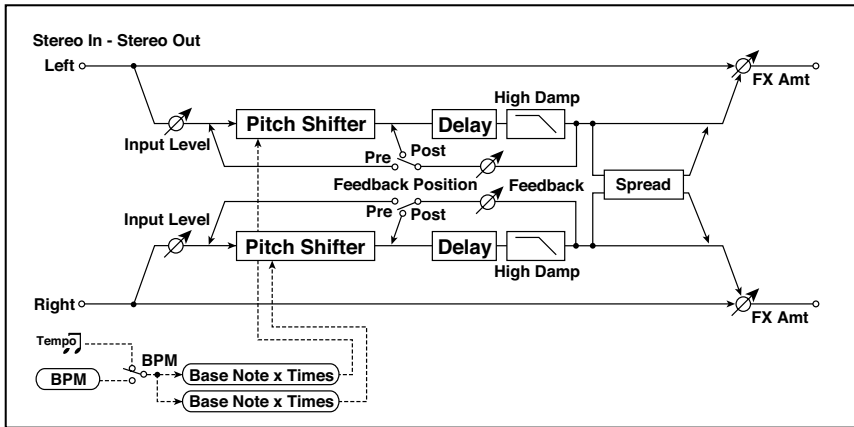
This stereo pitch shifter enables you to set the delay time to match the song tempo.



a	Mode	Slow, Medium, Fast	Switches Pitch Shifter mode
	L/R Pitch	Normal, Up/Down	Determines whether or not the L/R pitch shift amount is inverted
b	Pitch Shift [1/2tone]	-24...+24	Sets the pitch shift amount in steps of a semi-tone
	Src	Off...Tempo	Selects the modulation source of pitch shift amount
	Amt	-24...+24	Sets the modulation amount of pitch shift amount
c	Fine [cents]	-100...+100	Sets the pitch shift amount in steps of one cent
	Amt	-100...+100	Sets the modulation amount of pitch shift amount Sets the modulation amount of pitch shift amount
d	BPM	MIDI, 40.00... 300.00	MIDI syncs to the system tempo; 40-300 sets the tempo manually for this individual effect
	Time Over? L	---, OVER!	Display the error message if the left channel delay time exceeds the upper limit
	R	---, OVER!	Display the error message if the right channel delay time exceeds the upper limit

e	L Delay Base Note		Selects the type of notes to specify the left channel delay time
	Times	x1...x32	Sets the number of notes to specify the left channel delay time
f	R Delay Base Note		Selects the type of notes to specify the right channel delay time
	Times	x1...x32	Sets the number of notes to specify the right channel delay time
g	Feedback Position	Pre, Post	Switches the feedback connection
	Spread	-100...+100	Sets the width of the stereo image of the effect sound
h	Feedback	-100...+100	Sets the feedback amount
	High Damp [%]	0...100	Sets the damping amount in the high range
i	Input Level Dmod [%]	-100...+100	Sets the modulation amount of the input level
	Src	Off...Tempo	Selects the modulation source for the input level
j	Wet/Dry	Dry, 1:99...99:1, Wet	Balance between the wet and dry signal
	Src	Off...Tempo	See the list of DMS (Dynamic Modulation Sources) at the beginning of this part
	Amt	-100...+100	Amount of modulation source

Mixed

Stereo Decimator

This effect creates a rough sound like a cheap sampler by lowering the sampling frequency and data bit length. You can also simulate noise unique to a sampler (aliasing).

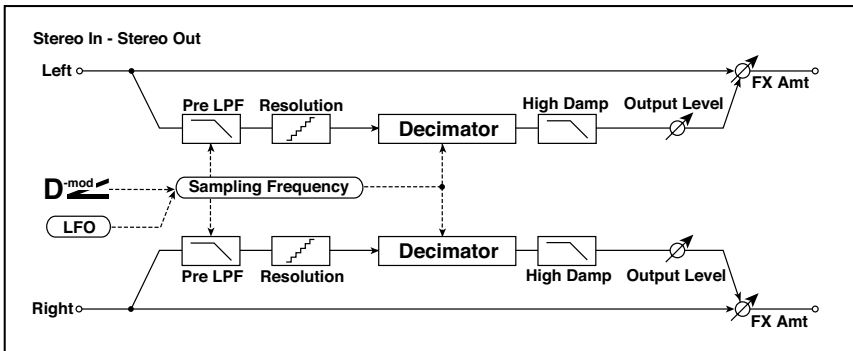

a	Pre LPF	Off, On	Selects whether the harmonic noise caused by a decrease in sampling frequency is generated or not
	High Damp [%]	0...100	Sets the ratio of cut of the high range
b	Sampling Freq [Hz]	1.00k... 48.00k	Sets the sampling frequency
	Src	Off...Tempo	Selects the modulation source of the sampling frequency
	Amt	-48.00k... +48.00k	Sets the modulation amount of the sampling frequency
c	LFO Frequency [Hz]	0.02...20.00	Sets the speed of the LFO
	Src	Off...Tempo	Selects a modulation source for LFO speed
	Amt	-20.00... +20.00	Sets the modulation amount of LFO speed

d	MIDI Sync	Off, On	When this is on, the LFO speed is set by BPM, Base Note, and Times, instead of Frequency
	BPM	MIDI, 40.00... 300.00	MIDI syncs to the system tempo; 40–300 sets the tempo manually for this individual effect
	Base Note		Selects the type of notes that specify the LFO speed
	Times	x1...x32	Sets the number of notes that specify the LFO speed
e	Depth	0...100	Sets the depth of the sampling frequency LFO modulation
	Src	Off...Tempo	Selects the LFO modulation source of the sampling frequency
	Amt	-100...+100	Sets the LFO modulation amount of the sampling frequency
f	Resolution	4...24	Sets the data bit length
g	Output Level	0...100	Sets the output level
	Src	Off...Tempo	Selects the modulation source for the output level
	Amt	-100...+100	Sets the modulation amount of the output level
h	Wet/Dry	Dry, 1:99...99:1, Wet	Balance between the wet and dry signal
	Src	Off...Tempo	See the list of DMS (Dynamic Modulation Sources) at the beginning of this part
	Amt	-100...+100	Amount of modulation source

■ a: Pre LPF

If a sampler with a very low sampling frequency receives very high-pitched sound that could not be heard during playback, it could generate pitch noise that is unrelated to the original sound. Set “Pre LPF” to On to prevent this noise from being generated.

If you set the “Sampling Freq” to about 3 kHz and set “Pre LPF” to Off, you can create a sound like a ring modulator.

■ f: Resolution

■ g: Output Level

If you set a smaller value for the “Resolution” parameter, the sound may be distorted. The volume level may also be changed. Use “Output Level” to adjust the level.

Stereo Analog Record

This effect simulates the noise caused by scratches and dust on analog records. It also reproduces some of the modulation caused by a warped turntable.

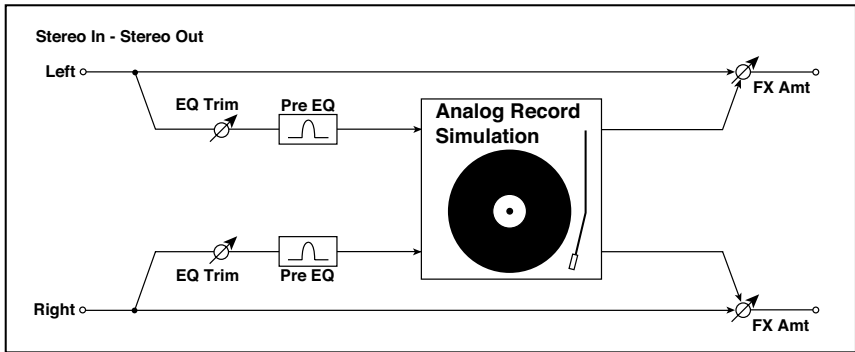

a	Speed [RPM]	33 1/3, 45, 78	Sets the r.p.m. of a record
b	Flutter	0...100	Sets the modulation depth
c	Noise Density	0...100	Sets the noise density
	Noise Tone	0...100	Sets the noise tone
d	Noise Level	0...100	Sets the noise level
	Src	Off...Tempo	Selects the modulation source for the noise level
	Amt	-100...+100	Sets the modulation amount of the noise level
e	Click Level	0...100	Sets the click noise level
	Src	Off...Tempo	Selects the modulation source for the click noise level
	Amt	-100...+100	Sets the modulation amount of the click noise level
f	EQ Trim	0...100	Sets the EQ input level
g	Pre EQ Cutoff [Hz]	300...10.00k	Sets the EQ center frequency
	Q	0.5...10.0	Sets the EQ band width
	Gain [dB]	-18.0...+18.0	Sets the EQ gain
h	Wet/Dry	Dry, 1:99...99:1, Wet	Balance between the wet and dry signal
	Src	Off...Tempo	See the list of DMS (Dynamic Modulation Sources) at the beginning of this part
	Amt	-100...+100	Amount of modulation source

■ **b: Flutter**

This parameter enables you to set the depth of the modulation caused by a warped turntable.

■ **e: Click Level**

This parameter enables you to set the level of the click noise that occurs once every rotation of the turntable. This simulation reproduces record noise, and the noise generated after the music on a vinyl record finishes.

Doppler

This effect simulates the “Doppler effect” of a moving sound with a changing pitch, similar to the siren of an ambulance. Mixing the effect sound with the dry sound will create a unique chorus effect.

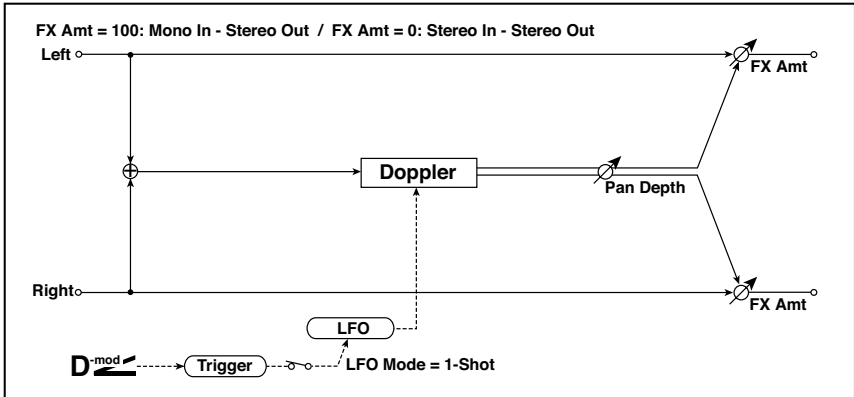

a	LFO Mode	Loop, 1-Shot	Switches LFO operation mode
	Src	Off...Tempo	Selects the modulation source of LFO reset
b	LFO Sync	Off, On	Switches between LFO reset on and off when LFO Mode is set to Loop
c	LFO Frequency [Hz]	0.02...20.00	Sets the speed of the LFO
	Src	Off...Tempo	Selects a modulation source for LFO speed
	Amt	-20.00...+20.00	Sets the modulation amount of LFO speed
d	MIDI Sync	Off, On	When this is on, the LFO speed is set by BPM, Base Note, and Times, instead of Frequency
	BPM	MIDI, 40.00...300.00	MIDI syncs to the system tempo; 40–300 sets the tempo manually for this individual effect
	Base Note		Selects the type of notes that specify the LFO speed
	Times	x1...x32	Sets the number of notes that specify the LFO speed
e	Pitch Depth	0...100	Sets the pitch variation of the moving sound
	Src	Off...Tempo	Selects the modulation source of pitch variation
	Amt	-100...+100	Sets the modulation amount of pitch variation
f	Pan Depth	-100...+100	Sets the panning of the moving sound
	Src	Off...Tempo	Selects the modulation source of panning
	Amt	-100...+100	Sets the modulation amount of panning
g	Wet/Dry	Dry, 1:99...99:1, Wet	Balance between the wet and dry signal
	Src	Off...Tempo	See the list of DMS (Dynamic Modulation Sources) at the beginning of this part
	Amt	-100...+100	Amount of modulation source

- **a: LFO Mode**

- **a: Src**

- **b: LFO Sync**

The “LFO Mode” parameter switches LFO operation mode. When Loop is selected, the Doppler effect will be created repeatedly. If “LFO Sync” is set to On, the LFO will be reset when the modulation source specified with the “Src” parameter is turned on.

When “LFO Mode” is set to 1-Shot, the Doppler effect is created only once when the modulation source specified in the “Src” field is turned on. At this time if you do not set the “Src” parameter, the Doppler effect will not be created, and no effect sound will be output.

MIDI The effect is off when a value for the modulation source specified for the “Src” parameter is smaller than 64, and the effect is on when the value is 64 or higher. The Doppler effect is triggered when the value changes from 63 or smaller to 64 or higher.

■ e: Pitch Depth

With the Doppler effect, the pitch is raised when the sound approaches, and the pitch is lowered when the sound goes away. This parameter sets this pitch variation.

■ f: Pan Depth

This parameter sets the width of the stereo image of the effect sound. With larger values, the sound seems to come and go from much further away. With positive values, the sound moves from left to right; with negative values, the sound moves from right to left.

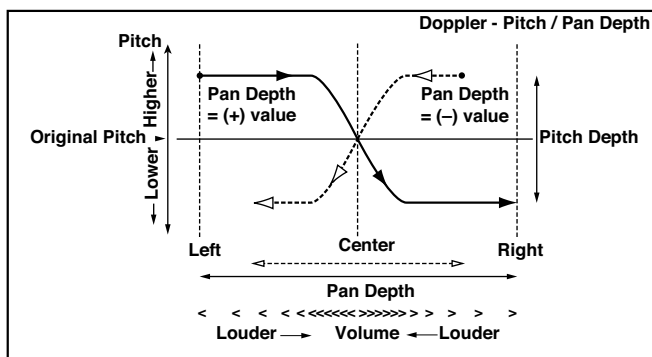

Scratch

This effect is applied by recording the input signal and moving the modulation source. It simulates the sound of scratches you can make using a turntable.

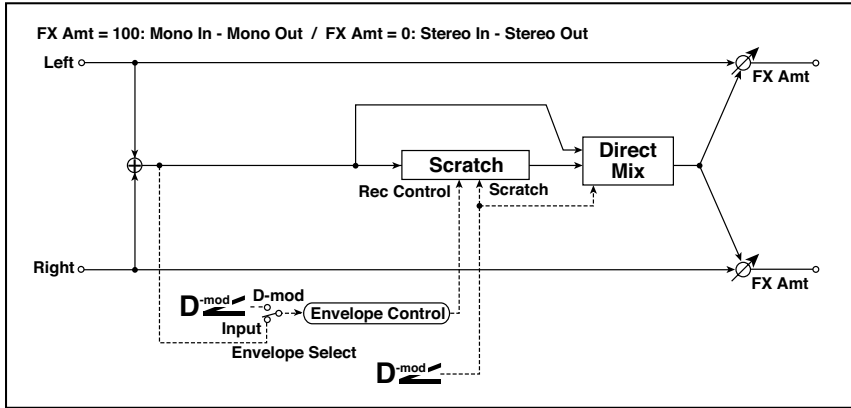

a	Scratch Source	Off...Tempo	Selects the modulation source for simulation control
b	Response	0...100	Sets the speed of the response to the Scratch Src
c	Envelope Select	D-mod, Input	Selects whether the start and end of recording is controlled via the modulation source or the input signal level
	Src	Off...Tempo	Selects the modulation source that controls recording when Envelope Select is set to D-mod
d	Threshold	0...100	Sets the recording start level when Envelope Select is set to Input
e	Response	0...100	Sets the speed of the response to the end of recording
f	Direct Mix	Always On, Always Off, Cross Fade	Selects how a dry sound is mixed
g	Wet/Dry	Dry, 1:99...99:1, Wet	Balance between the wet and dry signal
	Src	Off...Tempo	See the list of DMS (Dynamic Modulation Sources) at the beginning of this part
	Amt	-100...+100	Amount of modulation source

- **a: Scratch Source**
- **b: Response**

The Scratch Source parameter enables you to select the modulation source that controls simulation. The value of the modulation source corresponds to the playback position. The Response parameter enables you to set the speed of the response to the modulation source.

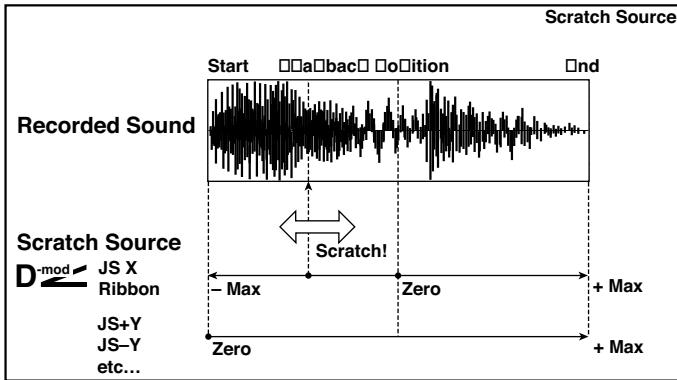

- **c: Envelope Select**
- **c: Src**
- **d: Threshold**

When “Envelope Select” is set to D-mod, the input signal will be recorded only when the modulation source value is 64 or higher.

When “Envelope Select” is set to Input, the input signal will be recorded only when its level is over the Threshold value.

The maximum recording time is 2,730msec. If this is exceeded, the recorded data will start being erased from the top.

- **e: Response**

This parameter enables you to set the speed of the response to the end of recording. Set a smaller value when you are recording a phrase or rhythm pattern, and set a higher value if you are recording only one note.

■ **f: Direct Mix**

With Always On, a dry sound is usually output. With Always Off, dry sounds are not output. With Cross Fade, a dry sound is usually output, and it is muted only when scratching.

Set Wet/Dry to 100 to use this parameter effectively.

Auto Reverse

This effect records the input signal and automatically plays it in reverse (the effect is similar to a tape reverse sound).

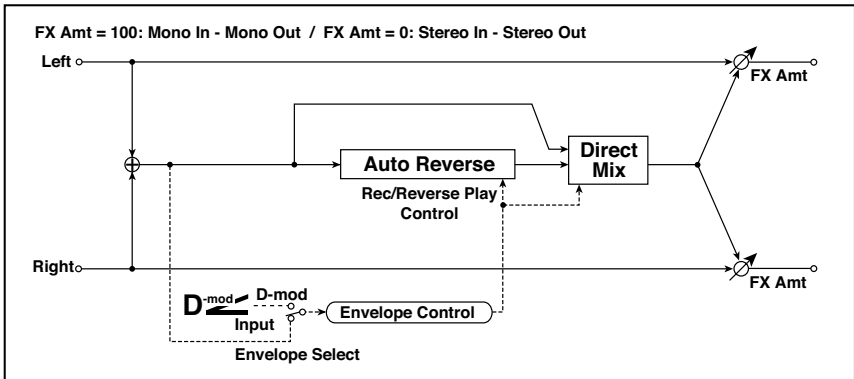

a	Rec Mode	Single, Multi	Sets the recording mode
b	Reverse Time [msec]	20...2640	Sets the maximum duration of the reverse playback
c	Envelope Select	D-mod, Input	Selects whether the start and end of recording is controlled via the modulation source or the input signal level
	Src	Off...Tempo	Selects the modulation source that controls recording when Envelope Select is set to D-mod
d	Threshold	0...100	Sets the recording start level when Envelope Select is set to Input
e	Response	0...100	Sets the speed of the response to the end of recording
f	Direct Mix	Always On, Always Off, Cross Fade	Selects how a dry sound is mixed
g	Wet/Dry	Dry, 1:99...99:1, Wet	Balance between the wet and dry signal
	Src	Off...Tempo	See the list of DMS (Dynamic Modulation Sources) at the beginning of this part
	Amt	-100...+100	Amount of modulation source

- **a: Rec Mode**
- **b: Reverse Time [msec]**

When “Rec Mode” is set to Single, you can set up to 2,640msec for “Reverse Time.” If recording starts during the reverse playback, the playback will be interrupted.

When “Rec Mode” is set to Multi, you can make another recording during the reverse playback. However, the maximum Reverse Time is limited to 1,320msec.

If you wish to record a phrase or rhythm pattern, set “Rec Mode” to Single. If you record only one note, set “Rec Mode” to Multi.

The “Reverse Time” parameter specifies the maximum duration of the reverse playback. The part in excess of this limit will not be played in reverse. If you wish to add short pieces of the reverse playback of single notes, make the “Reverse Time” shorter.

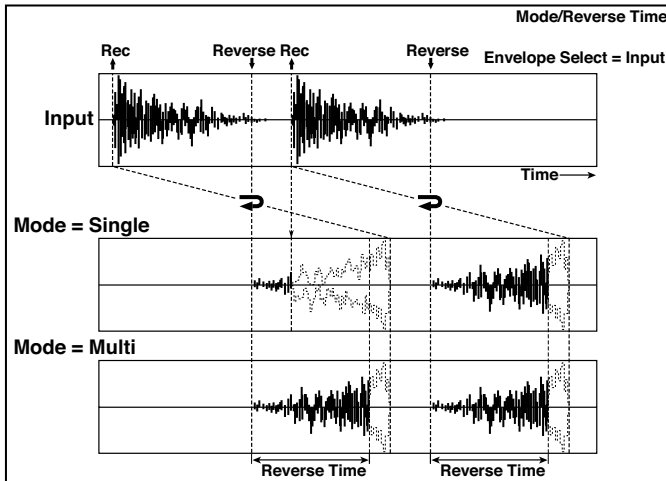

- **c: Envelope Select**
- **c: Src**
- **d: Threshold**

These parameters select the source to control the start and end of recording.

When “Envelope Select” is set to D-mod, the input signal will be recorded only when the value of the modulation source selected by the Src parameter is 64 or higher.

When “Envelope Select” is set to Input, the input signal will be recorded only when its level exceeds the Threshold level.

When recording is completed, reverse playback starts immediately.

P4EQ + Chorus/Flanger

This effect combines a mono four-band parametric equalizer and a chorus/flanger.

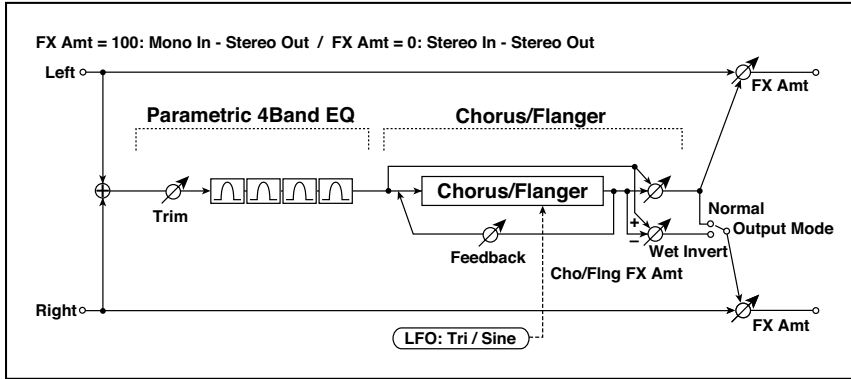

P4EQ

a	[E]Trim	0...100	Sets the parametric EQ input level
b	[E]B1 Cutoff [Hz]	20...1.00k	Sets the center frequency of Band 1
	Q	0.5...10.0	Sets the bandwidth of Band 1
	Gain [dB]	-18...+18	Sets the gain of Band 1
c	[E]B2 Cutoff [Hz]	50...5.00k	Sets the center frequency of Band 2
	Q	0.5...10.0	Sets the bandwidth of Band 2
	Gain [dB]	-18...+18	Sets the gain of Band 2
d	[E]B3 Cutoff [Hz]	300...10.00k	Sets the center frequency of Band 3
	Q	0.5...10.0	Sets the bandwidth of Band 3
	Gain [dB]	-18...+18	Sets the gain of Band 3
e	[E]B4 Cutoff [Hz]	500...20.00k	Sets the center frequency of Band 4
	Q	0.5...10.0	Sets the bandwidth of Band 4
	Gain [dB]	-18...+18	Sets the gain of Band 4

CHORUS/FLANGER

f	[F]LFO Frequency [Hz]	0.02...20.00	Sets the speed of the LFO
	LFO Waveform	Triangle, Sine	Selects the LFO Waveform

g	[F]Delay Time [msec]	0.0...1350.0	Sets the delay time
	Depth	0...100	Sets the depth of LFO modulation
	Feedback	-100...+100	Sets the feedback amount
h	[F]Cho/Fing Wet/Dry	-Wet, -1:99... Dry...99:1, Wet	Sets the effect balance of the chorus/flanger
	Src	Off...Tempo	Selects the Wet/Dry modulation source for the chorus/flanger
	Amt	-100...+100	Sets the Wet/Dry modulation amount for the chorus/flanger
i	[F]Output Mode	Normal, Wet Invert	Selects the output mode for the chorus/flanger
j	Wet/Dry	Dry, 1:99...99:1, Wet	Balance between the wet and dry signal
	Src	Off...Tempo	See the list of DMS (Dynamic Modulation Sources) at the beginning of this part
	Amt	-100...+100	Amount of modulation source

■ i: Output Mode

When Wet Invert is selected, the right channel phase of the chorus/flanger effect sound is inverted. This creates pseudo-stereo effects and adds spread.

However, if a mono-input type effect is connected after this effect, the left and right sounds may cancel each other, eliminating the chorus/flanger effects.

P4EQ + Phaser

This effect combines a mono four-band parametric equalizer and a phaser.

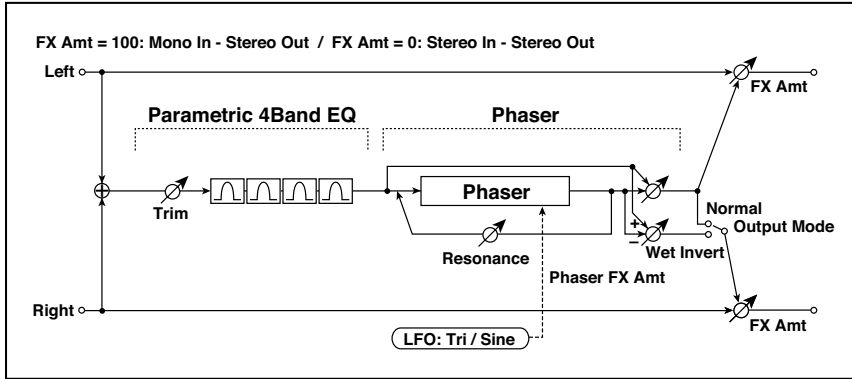

P4EQ

a	[E]Trim	0...100	Sets the parametric EQ input level
b	[E]B1 Cutoff [Hz]	20...1.00k	Sets the center frequency of Band 1
	Q	0.5...10.0	Sets the bandwidth of Band 1
	Gain [dB]	-18...+18	Sets the gain of Band 1
c	[E]B2 Cutoff [Hz]	50...5.00k	Sets the center frequency of Band 2
	Q	0.5...10.0	Sets the bandwidth of Band 2
	Gain [dB]	-18...+18	Sets the gain of Band 2
d	[E]B3 Cutoff [Hz]	300...10.00k	Sets the center frequency of Band 3
	Q	0.5...10.0	Sets the bandwidth of Band 3
	Gain [dB]	-18...+18	Sets the gain of Band 3
e	[E]B4 Cutoff [Hz]	500...20.00k	Sets the center frequency of Band 4
	Q	0.5...10.0	Sets the bandwidth of Band 4
	Gain [dB]	-18...+18	Sets the gain of Band 4

PHASER

f	[P]LFO Frequency [Hz]	0.02...20.00	Sets the speed of the LFO
	LFO Waveform	Triangle, Sine	Selects the LFO Waveform
g	[P]Manual	0...100	Sets the frequency to which the effect is applied
	Depth	0...100	Sets the depth of LFO modulation
	Resonance	-100...+100	Sets the resonance amount
h	[P]Phaser Wet/Dry	-Wet, -1:99... Dry...99:1, Wet	Sets the phaser effect balance
	Src	Off...Tempo	Selects the Wet/Dry modulation source for the phaser
	Amt	-100...+100	Sets the Wet/Dry modulation amount for the phaser
i	[P]Output Mode	Normal, Wet Invert	Selects the phaser output mode
j	Wet/Dry	Dry, 1:99...99:1, Wet	Balance between the wet and dry signal
	Src	Off...Tempo	See the list of DMS (Dynamic Modulation Sources) at the beginning of this part
	Amt	-100...+100	Amount of modulation source

P4EQ + Multitap Delay

This effect combines a mono four-band parametric equalizer and a multitap delay.

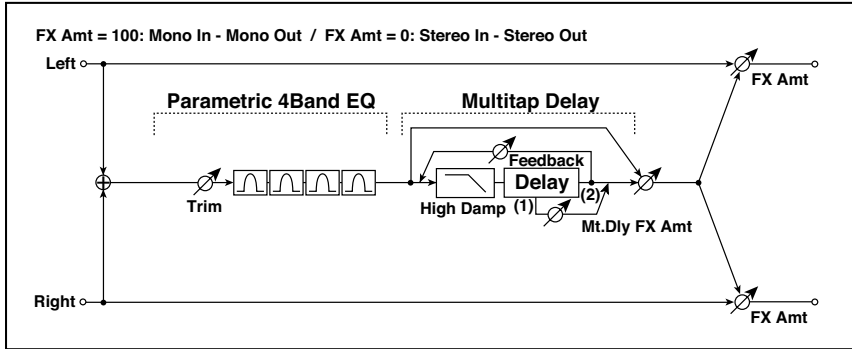

P4EQ

a	[E]Trim	0...100	Sets the parametric EQ input level
b	[E]B1 Cutoff [Hz]	20...1.00k	Sets the center frequency of Band 1
	Q	0.5...10.0	Sets the bandwidth of Band 1
	Gain [dB]	-18...+18	Sets the gain of Band 1
c	[E]B2 Cutoff [Hz]	50...5.00k	Sets the center frequency of Band 2
	Q	0.5...10.0	Sets the bandwidth of Band 2
	Gain [dB]	-18...+18	Sets the gain of Band 2
d	[E]B3 Cutoff [Hz]	300...10.00k	Sets the center frequency of Band 3
	Q	0.5...10.0	Sets the bandwidth of Band 3
	Gain [dB]	-18...+18	Sets the gain of Band 3
e	[E]B4 Cutoff [Hz]	500...20.00k	Sets the center frequency of Band 4
	Q	0.5...10.0	Sets the bandwidth of Band 4
	Gain [dB]	-18...+18	Sets the gain of Band 4

MULTITAP DELAY

f	[D]Tap1 Time [msec]	0.0...1360.0	Sets the Tap1 delay time
	Tap1 Level	0...100	Sets the Tap1 output level
g	[D]Tap2 Time [msec]	0.0...1360.0	Sets the Tap2 delay time
	Feedback (Tap2)	-100...+100	Sets the Tap2 feedback amount
h	[D]High Damp [%]	0...100	Sets the damping amount in the high range

i	[D]Mt.Delay Wet/Dry	Dry, 1:99...99:1, Wet	Sets the multitap delay effect balance
	Src	Off...Tempo	Selects the Wet/Dry modulation source for the multitap delay
	Amt	-100...+100	Sets the Wet/Dry modulation amount for the multitap delay
j	Wet/Dry	Dry, 1:99...99:1, Wet	Balance between the wet and dry signal
	Src	Off...Tempo	See the list of DMS (Dynamic Modulation Sources) at the beginning of this part
	Amt	-100...+100	Amount of modulation source

Compressor + Wah

This effect combines a mono compressor and a wah. You can change the order of the connection.

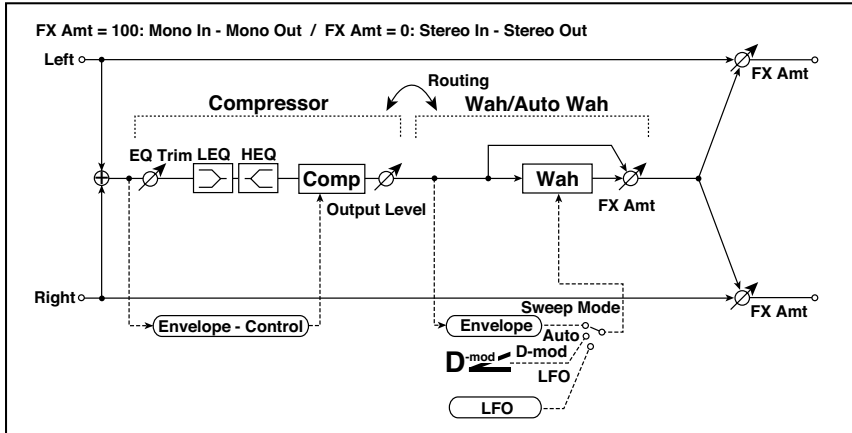

COMPRESSOR

a	[C] Sensitivity	1...100	Sets the sensitivity
b	[C]Attack	1...100	Sets the attack level
	Output Level	0...100	Sets the compressor output level
c	[C]EQ Trim	0...100	Sets the EQ input level
d	[C]Pre LEQ Gain [dB]	-15...+15	Sets the gain of Low EQ
	Pre HEQ Gain [dB]	-15...+15	Sets the gain of High EQ

WAH

e	[W]Frequency Bottom	0...100	Sets the lower limit of the wah center frequency
	Frequency Top	0...100	Sets the upper limit of the wah center frequency
f	[w]Sweep Mode	Auto, D-mod, LFO	Selects the control from auto-wah, modulation source, and LFO
	Src	Off...Tempo	Selects the modulation source for the wah when Sweep Mode=D-mod
g	[W]LFO Frequency [Hz]	0.02...20.00	Sets the speed of the LFO
	Resonance	0...100	Sets the resonance amount
	LPF	Off, On	Switches the wah low pass filter on and off
h	[W]Wet/Dry	Dry, 1:99...99:1, Wet	Sets the wah effect balance
	Src	Off...Tempo	Selects the Wet/Dry modulation source for the wah
	Amt	-100...+100	Sets the Wet/Dry modulation amount for the wah
i	Routing	Comp > Wah, Wah > Comp	Switches the order of the compressor and wah
j	Wet/Dry	Dry, 1:99...99:1, Wet	Balance between the wet and dry signal
	Src	Off...Tempo	See the list of DMS (Dynamic Modulation Sources) at the beginning of this part
	Amt	-100...+100	Amount of modulation source

Compressor + P4EQ

This effect combines a mono compressor and a four-band parametric equalizer. You can change the order of the effects.

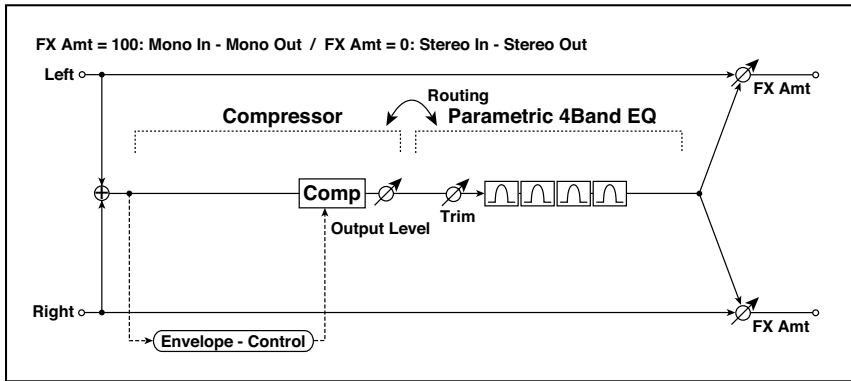

COMPRESSOR

a	[C]Sensitivity	1...100	Sets the sensitivity
b	[C]Attack	1...100	Sets the attack level
	Output Level	0...100	Sets the compressor output level

P4EQ

c	[E]Trim	0...100	Sets the parametric EQ input level
d	[E]B1 Cutoff [Hz]	20...1.00k	Sets the center frequency of Band 1
	Q	0.5...10.0	Sets the bandwidth of Band 1
	Gain [dB]	-18...+18	Sets the gain of Band 1
e	[E]B2 Cutoff [Hz]	50...5.00k	Sets the center frequency of Band 2
	Q	0.5...10.0	Sets the bandwidth of Band 2
	Gain [dB]	-18...+18	Sets the gain of Band 2
f	[E]B3 Cutoff [Hz]	300...10.00k	Sets the center frequency of Band 3
	Q	0.5...10.0	Sets the bandwidth of Band 3
	Gain [dB]	-18...+18	Sets the gain of Band 3
g	[E]B4 Cutoff [Hz]	500...20.00k	Sets the center frequency of Band 4
	Q	0.5...10.0	Sets the bandwidth of Band 4
	Gain [dB]	-18...+18	Sets the gain of Band 4
h	Routing	Comp > P4EQ, P4EQ > Comp	Switches the order of the compressor and parametric EQ

i	Wet/Dry	Dry, 1:99...99:1, Wet	Balance between the wet and dry signal
	Src	Off...Tempo	See the list of DMS (Dynamic Modulation Sources) at the beginning of this part
	Amt	-100...+100	Amount of modulation source

Compressor + Chorus/Flanger

This effect combines a mono compressor and a chorus/flanger. You can change the order of the effects.

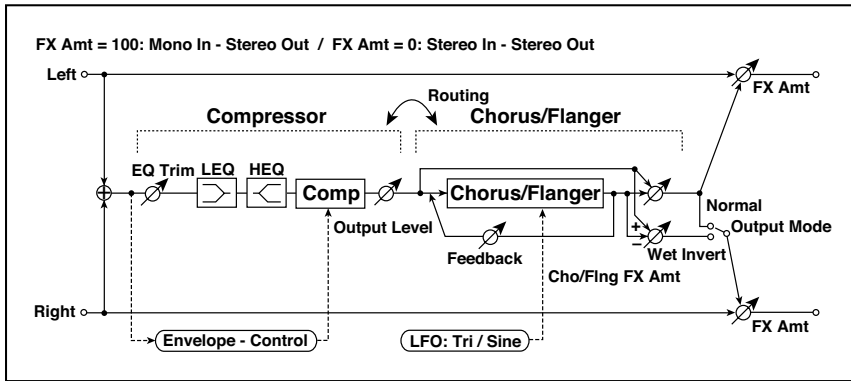

COMPRESSOR

a	[C] Sensitivity	1...100	Sets the sensitivity
b	[C]Attack	1...100	Sets the attack level
	Output Level	0...100	Sets the compressor output level
c	[C]EQ Trim	0...100	Sets the EQ input level
d	[C]Pre LEQ Gain [dB]	-15...+15	Sets the gain of Low EQ
	Pre HEQ Gain [dB]	-15...+15	Sets the gain of High EQ

CHORUS/FLANGER

e	[F]LFO Frequency [Hz]	0.02...20.00	Sets the speed of the LFO
	LFO Waveform	Triangle, Sine	Selects the LFO Waveform
f	[F]Delay Time [msec]	0.0...1350.0	Sets the delay time
	Depth	0...100	Sets the depth of LFO modulation
	Feedback	-100...+100	Sets the feedback amount
g	[F]Cho/Fing Wet/Dry	-Wet, -1:99... Dry...99:1, Wet	Sets the effect balance of the chorus/flanger
	Src	Off...Tempo	Selects the Wet/Dry modulation source for the chorus/flanger
	Amt	-100...+100	Sets the Wet/Dry modulation amount for the chorus/flanger

h	[F]Output Mode	Normal, Wet Invert	Selects the output mode for the chorus/flanger
i	Routing	Comp › Flanger, Flanger › Comp	Switches the order of the compressor and chorus/flanger
j	Wet/Dry	Dry, 1:99...99:1, Wet	Balance between the wet and dry signal
	Src	Off...Tempo	See the list of DMS (Dynamic Modulation Sources) at the beginning of this part
	Amt	-100...+100	Amount of modulation source

■ h: [F]Output Mode

■ i: Routing

When Wet Invert is selected, the right channel phase of the chorus/flanger effect sound is inverted. This creates pseudo-stereo effects and adds spread.

However, if a mono-input type effect is connected after this effect, the left and right sounds may cancel each other, eliminating the chorus/flanger effects.

When “Routing” is set to Flanger/Comp, “[F]Output Mode” will be set to Normal.

Compressor + Phaser

This effect combines a mono compressor and a phaser. You can change the order of the effects.

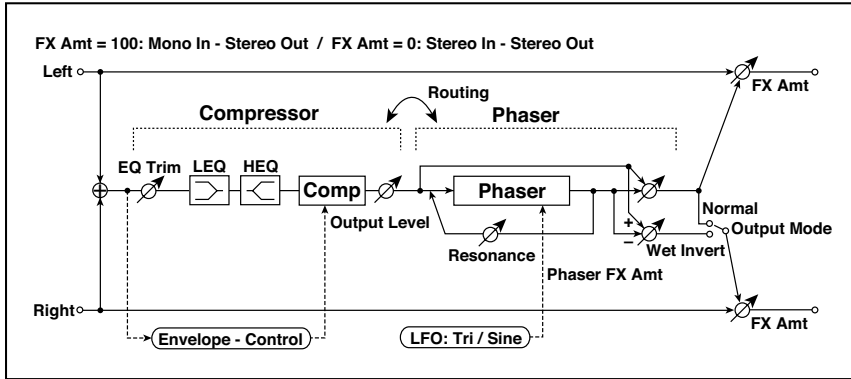

COMPRESSOR

a	[C] Sensitivity	1...100	Sets the sensitivity
b	[C]Attack	1...100	Sets the attack level
	Output Level	0...100	Sets the compressor output level
c	[C]EQ Trim	0...100	Sets the EQ input level
d	[C]Pre LEQ Gain [dB]	-15...+15	Sets the gain of Low EQ
	Pre HEQ Gain [dB]	-15...+15	Sets the gain of High EQ

PHASER

e	[P]LFO Frequency [Hz]	0.02...20.00	Sets the speed of the LFO
	LFO Waveform	Triangle, Sine	Selects the LFO Waveform
f	[P]Manual	0...100	Sets the frequency to which the effect is applied
	Depth	0...100	Sets the depth of LFO modulation
	Resonance	-100...+100	Sets the resonance amount
g	[P]Phaser Wet/Dry	-Wet, -1:99... Dry...99:1, Wet	Sets the phaser effect balance
	Src	Off...Tempo	Selects the Wet/Dry modulation source for the phaser
	Amt	-100...+100	Sets the Wet/Dry modulation amount for the phaser
h	[F]Output Mode	Normal, Wet Invert	Selects the phaser output mode

i	Routing	Comp › Phaser, Phaser › Comp	Switches the order of the compressor and phaser
j	Wet/Dry	Dry, 1:99...99:1 Wet	Balance between the wet and dry signal
	Src	Off...Tempo	See the list of DMS (Dynamic Modulation Sources) at the beginning of this part
	Amt	-100...+100	Amount of modulation source

Compressor + Multitap Delay

This effect combines a mono compressor and a multitap delay. You can change the order of the effects.

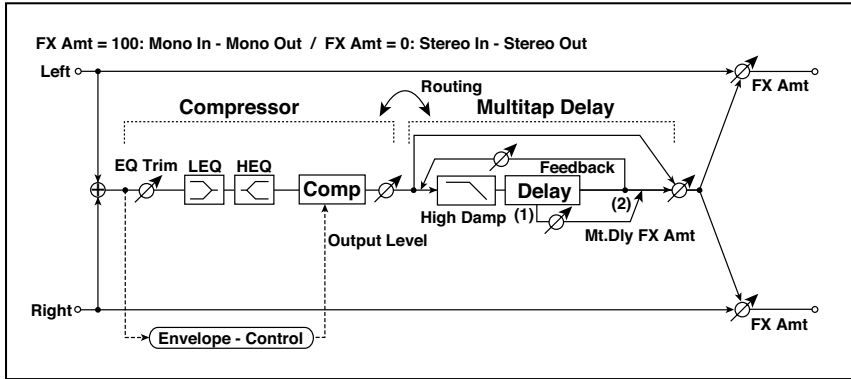

COMPRESSOR

a	[C]Sensitivity	1...100	Sets the sensitivity
b	[C]Attack	1...100	Sets the attack level
	Output Level	0...100	Sets the compressor output level
c	[C]EQ Trim	0...100	Sets the EQ input level
d	[C]Pre LEQ Gain [dB]	-15...+15	Sets the gain of Low EQ
	Pre HEQ Gain [dB]	-15...+15	Sets the gain of High EQ

MULTITAP DELAY

e	[D]Tap1 Time [msec]	0.0...1360.0	Sets the Tap1 delay time
	Tap1 Level	0...100	Sets the Tap1 output level
f	[D]Tap2 Time [msec]	0.0...1360.0	Sets the Tap2 delay time
	Feedback (Tap2)	-100...+100	Sets the Tap2 feedback amount
g	[D]High Damp [%]	0...100	Sets the damping amount in the high range

h	[D]Mt.Delay Wet/Dry	Dry, 1 : 99...99 : 1, Wet	Sets the multitap delay effect balance
	Src	Off...Tempo	Selects the Wet/Dry modulation source for the multitap delay
	Amt	-100...+100	Sets the Wet/Dry modulation amount for the multitap delay
i	Routing	Comp › Mt.Delay, Mt.Delay › Comp	Switches the order of the compressor and multitap delay
j	Wet/Dry	Dry, 1:99...99:1, Wet	Balance between the wet and dry signal
	Src	Off...Tempo	See the list of DMS (Dynamic Modulation Sources) at the beginning of this part
	Amt	-100...+100	Amount of modulation source

Limiter + P4EQ

This effect combines a mono limiter and a four-band parametric equalizer. You can change the order of the effects.

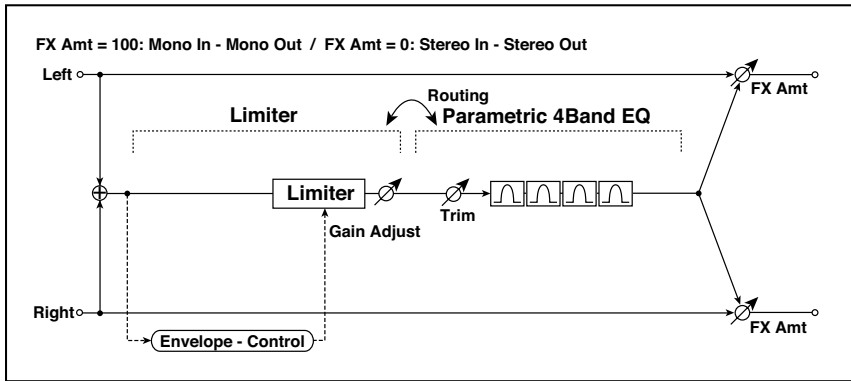

LIMITER

a	[L]Ratio	1.0 : 1... 50.0 : 1, Inf : 1	Sets the signal compression ratio
	Threshold [dB]	-40...0	Sets the level above which the compressor is applied
b	[L]Attack	1...100	Sets the attack time
	Release	1...100	Sets the release time
c	[L]Gain Adjust [dB]	-Inf, -38...+24	Sets the limiter output gain

P4EQ

d	[E]Trim	0...100	Sets the parametric EQ input level
e	[E]B1 Cutoff [Hz]	20...1.00k	Sets the center frequency of Band 1
	Q	0.5...10.0	Sets the bandwidth of Band 1
	Gain [dB]	-18...+18	Sets the gain of Band 1
f	[E]B2 Cutoff [Hz]	50...5.00k	Sets the center frequency of Band 2
	Q	0.5...10.0	Sets the bandwidth of Band 2
	Gain [dB]	-18...+18	Sets the gain of Band 2
g	[E]B3 Cutoff [Hz]	300...10.00k	Sets the center frequency of Band 3
	Q	0.5...10.0	Sets the bandwidth of Band 3
	Gain [dB]	-18...+18	Sets the gain of Band 3

h	[E]B4 Cutoff [Hz]	500...20.00k	Sets the center frequency of Band 4
	Q	0.5...10.0	Sets the bandwidth of Band 4
	Gain [dB]	-18...+18	Sets the gain of Band 4
i	Routing	Limiter > P4EQ, P4EQ > Limiter	Switches the order of the limiter and parametric EQ
j	Wet/Dry	Dry, 1:99...99:1, Wet	Balance between the wet and dry signal
	Src	Off...Tempo	See the list of DMS (Dynamic Modulation Sources) at the beginning of this part
	Amt	-100...+100	Amount of modulation source

- **a: [L]Ratio**

- **a: Threshold [dB]**

- **c: [L]Gain Adjust [dB]**

This parameter sets the signal compression “[L]Ratio”. Compression is applied only when the signal level exceeds the “Threshold” value.

Adjust the output level using the “Gain Adjust” parameter, since compression causes the entire level to be reduced.

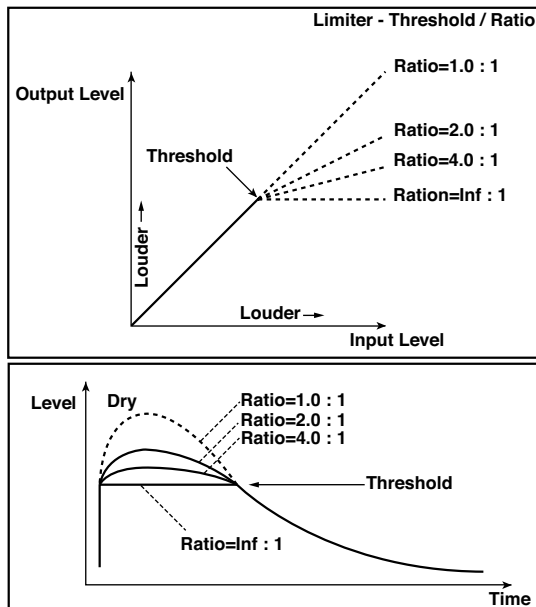

Limiters + Chorus/Flanger

This effect combines a mono limiter and a chorus/flanger. You can change the order of the effects.

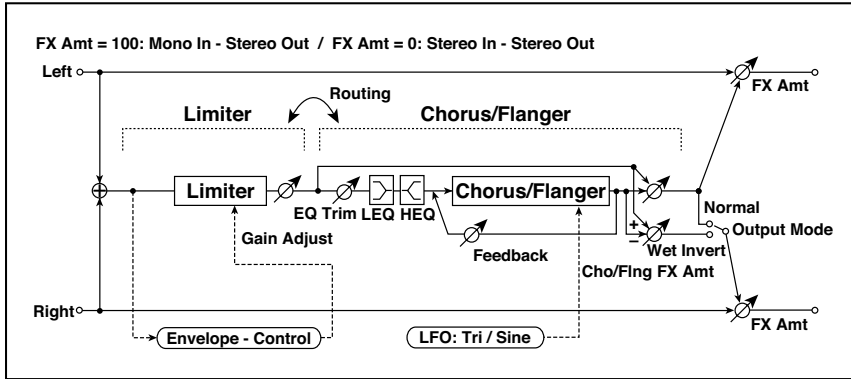

LIMITER

a	[L]Ratio	1.0 : 1... 50.0 : 1, Inf : 1	Sets the signal compression ratio
	Threshold [dB]	-40...0	Sets the level above which the compressor is applied
b	[L]Attack	1...100	Sets the attack time
	Release	1...100	Sets the release time
c	[L]Gain Adjust [dB]	-Inf, -38...+24	Sets the limiter output gain

CHORUS/FLANGER

d	[F]LFO Frequency [Hz]	0.02...20.00	Sets the speed of the LFO
	LFO Waveform	Triangle, Sine	Selects the LFO Waveform
e	[F]Delay Time [msec]	0.0...1350.0	Sets the delay time
	Depth	0...100	Sets the depth of LFO modulation
	Feedback	-100...+100	Sets the feedback amount
f	[F]EQ Trim	0...100	Sets the EQ input level
g	[F]Pre LEQ Gain [dB]	-15...+15	Sets the gain of Low EQ
	Pre HEQ Gain [dB]	-15...+15	Sets the gain of High EQ

h	[F]Cho/Fing Wet/Dry	-Wet, -1:99... Dry...99:1, Wet	Sets the effect balance of the chorus/flanger
	Src	Off...Tempo	Selects the Wet/Dry modulation source for the chorus/flanger
	Amt	-100...+100	Sets the Wet/Dry modulation amount for the chorus/flanger
i	[F]Output Mode	Normal, Wet Invert	Selects the output mode for the chorus/flanger
	Routing	Limiter > Flanger, Flanger > Limiter	Switches the order of the limiter and chorus/flanger
j	Wet/Dry	Dry, 1:99...99:1, Wet	Balance between the wet and dry signal
	Src	Off...Tempo	See the list of DMS (Dynamic Modulation Sources) at the beginning of this part
	Amt	-100...+100	Amount of modulation source

Limiter + Phaser

This effect combines a mono limiter and a phaser. You can change the order of the effects.

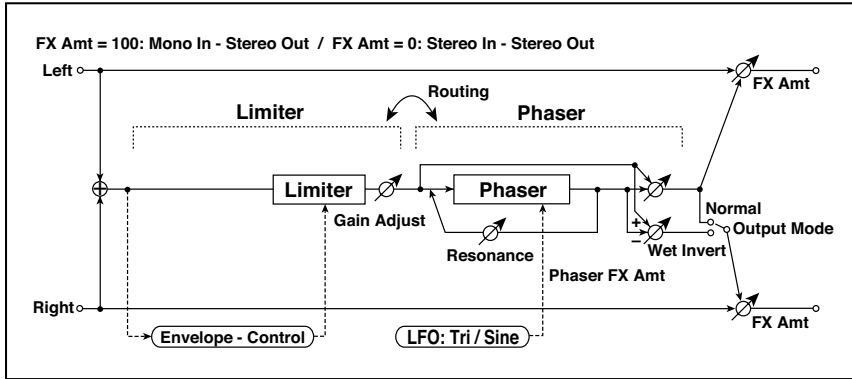

LIMITER

a	[L]Ratio	1.0 : 1... 50.0 : 1, Inf : 1	Sets the signal compression ratio
	Threshold [dB]	-40...0	Sets the level above which the compressor is applied
b	[L]Attack	1...100	Sets the attack time
	Release	1...100	Sets the release time
c	[L]Gain Adjust [dB]	-Inf, -38...+24	Sets the limiter output gain

PHASER

d	[P]LFO Frequency [Hz]	0.02...20.00	Sets the speed of the LFO
	LFO Waveform	Triangle, Sine	Selects the LFO Waveform
e	[P]Manual	0...100	Sets the frequency to which the effect is applied
	Depth	0...100	Sets the depth of LFO modulation
	Resonance	-100...+100	Sets the resonance amount
f	[P]Phaser Wet/Dry	-Wet, -1:99... Dry...99:1, Wet	Sets the phaser effect balance
	Src	Off...Tempo	Selects the phaser's Wet/Dry modulation source
	Amt	-100...+100	Sets the phaser's Wet/Dry modulation amount
g	[P]Output Mode	Normal, Wet Invert	Selects the phaser output mode

h	Routing	Limiter › Phaser, Phaser › Limiter	Switches the order of the limiter and phaser
i	Wet/Dry	Dry, 1:99...99:1, Wet	Balance between the wet and dry signal
	Src	Off...Tempo	See the list of DMS (Dynamic Modulation Sources) at the beginning of this part
	Amt	-100...+100	Amount of modulation source

Limiter + Multitap Delay

This effect combines a mono limiter and a multitap delay. You can change the order of the effects.

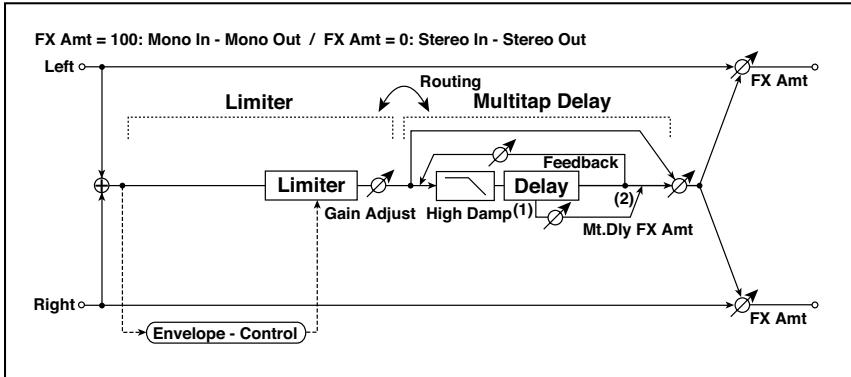

LIMITER

a	[L]Ratio	1.0:1... 50.0:1, Inf:1	Sets the signal compression ratio
	Threshold [dB]	-40...0	Sets the level above which the compressor is applied
b	[L]Attack	1...100	Sets the attack time
	Release	1...100	Sets the release time
c	[L]Gain Adjust [dB]	-Inf, -38...+24	Sets the limiter output gain

MULTITAP DELAY

d	[D]Tap1 Time [msec]	0.0...1360.0	Sets the Tap1 delay time
	Tap1 Level	0...100	Sets the Tap1 output level
e	[D]Tap2 Time [msec]	0.0...1360.0	Sets the Tap2 delay time
	Feedback	-100...+100	Sets the Tap2 feedback amount
f	[D]High Damp [%]	0...100	Sets the damping amount in the high range
g	[D]Mt.Delay Wet/ Dry	Dry, 1:99...99:1, Wet	Sets the multitap delay effect balance
	Src	Off...Tempo	Selects the multitap delay's Wet/Dry modulation source
	Amt	-100...+100	Sets the multitap delay's Wet/Dry modulation amount
h	Routing	Limiter > Mt.Delay, Mt.Delay > Limiter	Switches the order of the limiter and multitap delay
i	Wet/Dry	Dry, 1:99...99:1, Wet	Balance between the wet and dry signal
	Src	Off...Tempo	See the list of DMS (Dynamic Modulation Sources) at the beginning of this part
	Amt	-100...+100	Amount of modulation source

Exciter + Compressor

This effect combines a mono exciter and a compressor. You can change the order of the effects.

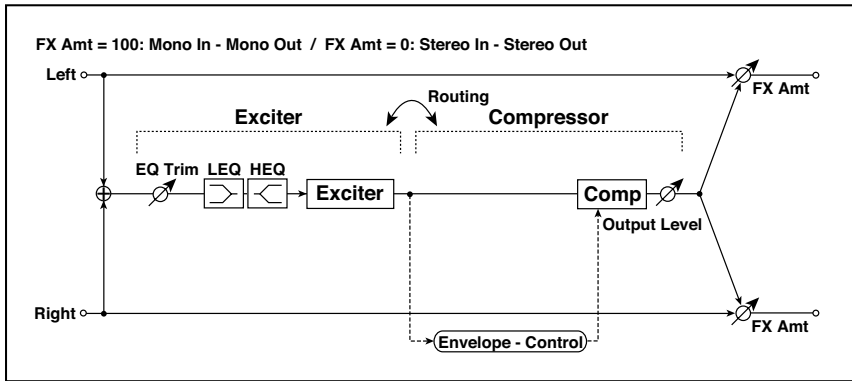

EXCITER

a	[X]Exciter Blend	-100...+100	Sets the intensity (depth) of the Exciter effect
b	[X]Emphasis Frequency	0...70	Sets the frequency range to be emphasized
c	[X]EQ Trim	0...100	Sets the EQ input level
d	[X]Pre LEQ Gain [dB]	-15...+15	Sets the gain of Low EQ
	Pre HEQ Gain [dB]	-15...+15	Sets the gain of High EQ

COMPRESSOR

e	[C] Sensitivity	1...100	Sets the sensitivity
f	[C]Attack	1...100	Sets the attack level
	Output Level	0...100	Sets the compressor output level
g	Routing	Exciter > Comp, Comp > Exciter	Switches the order of the exciter and compressor
h	Wet/Dry	Dry, 1:99...99:1, Wet	Balance between the wet and dry signal
	Src	Off...Tempo	See the list of DMS (Dynamic Modulation Sources) at the beginning of this part
	Amt	-100...+100	Amount of modulation source

Exciter + Limiter

This effect combines a mono exciter and a limiter. You can change the order of the effects.

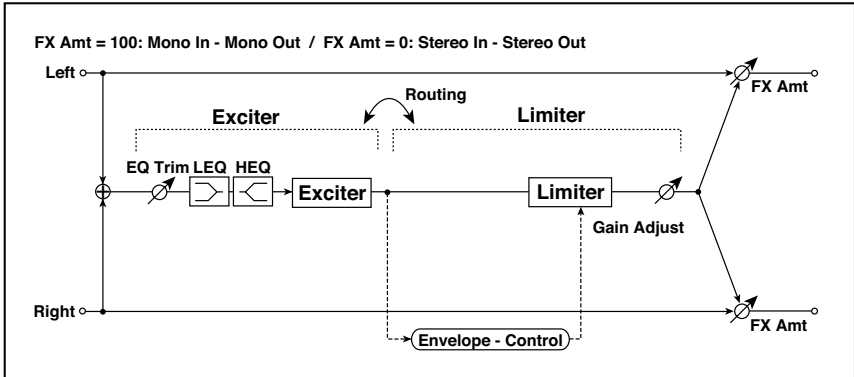

EXCITER

a	[X]Exciter Blend	-100...+100	Sets the intensity (depth) of the Exciter effect
b	[X]Emphasis Frequency	0...70	Sets the frequency range to be emphasized
c	[X]Trim	0...100	Sets the EQ input level
d	[X]Pre LEQ Gain [dB]	-15...+15	Sets the gain of Low EQ
	Pre HEQ Gain [dB]	-15...+15	Sets the gain of High EQ

LIMITER

e	[L]Ratio	1.0 : 1... 50.0 : 1, Inf : 1	Sets the signal compression ratio
f	[L]Threshold [dB]	-40...0	Sets the level above which the compressor is applied
g	[L]Attack	1...100	Sets the attack time
	Release	1...100	Sets the release time
h	[L]Gain Adjust [dB]	-Inf, -38...+24	Sets the limiter output gain
i	Routing	Exciter > Limiter, Limiter > Exciter	Switches the order of the exciter and limiter
j	Wet/Dry	Dry, 1:99...99:1, Wet	Balance between the wet and dry signal
	Src	Off...Tempo	See the list of DMS (Dynamic Modulation Sources) at the beginning of this part
	Amt	-100...+100	Amount of modulation source

Exciter + Chorus/Flanger

This effect combines a mono limiter and a chorus/flanger.

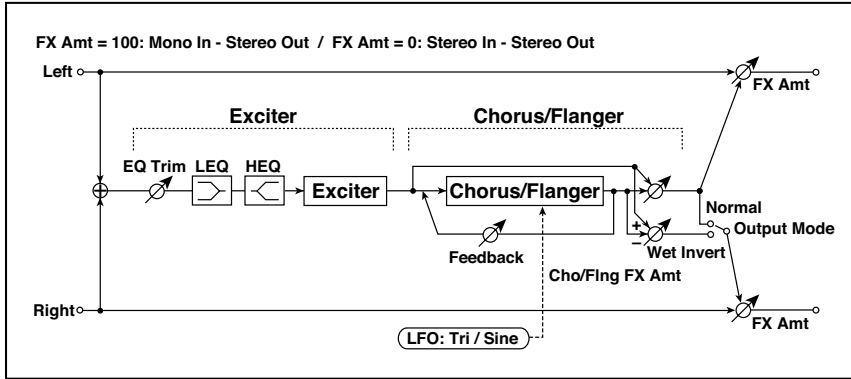

EXCITER

a	[X]Exciter Blend	-100...+100	Sets the intensity (depth) of the Exciter effect
b	[X]Emphasis Frequency	0...70	Sets the frequency range to be emphasized
c	[X]Trim	0...100	Sets the EQ input level
d	[X]Pre LEQ Gain [dB]	-15...+15	Sets the gain of Low EQ
	Pre HEQ Gain [dB]	-15...+15	Sets the gain of High EQ

CHORUS/FLANGER

e	[F]LFO Frequency [Hz]	0.02...20.00	Sets the speed of the LFO
	LFO Waveform	Triangle, Sine	Selects the LFO Waveform
f	[F]Delay Time [msec]	0.0...1350.0	Sets the delay time
	Depth	0...100	Sets the depth of LFO modulation
	Feedback	-100...+100	Sets the feedback amount
g	[F]Cho/Fling Wet/Dry	-Wet, -1:99... Dry...99:1, Wet	Sets the effect balance of the chorus/flanger
	Src	Off...Tempo	Selects the Wet/Dry modulation source for the chorus/flanger
	Amt	-100...+100	Sets the Wet/Dry modulation amount for the chorus/flanger
h	[F]Output Mode	Normal, Wet Invert	Selects the output mode for the chorus/flanger

i	Wet/Dry	Dry, 1:99...99:1, Wet	Balance between the wet and dry signal
	Src	Off...Tempo	See the list of DMS (Dynamic Modulation Sources) at the beginning of this part
	Amt	-100...+100	Amount of modulation source

Exciter + Phaser

This effect combines a mono limiter and a phaser.

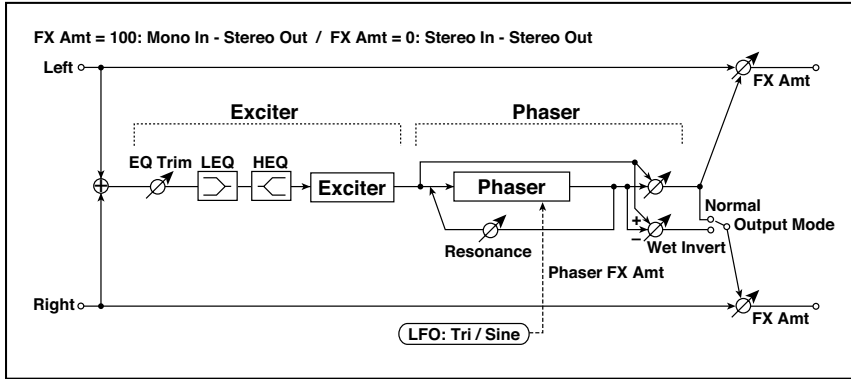

EXCITER

a	[X]Exciter Blend	-100...+100	Sets the intensity (depth) of the Exciter effect
b	[X]Emphasis Frequency	0...70	Sets the frequency range to be emphasized
c	[X]Trim	0...100	Sets the EQ input level
d	[X]Pre LEQ Gain [dB]	-15...+15	Sets the gain of Low EQ
	Pre HEQ Gain [dB]	-15...+15	Sets the gain of High EQ

PHASER

e	[P]LFO Frequency [Hz]	0.02...20.00	Sets the speed of the LFO
	LFO Waveform	Triangle, Sine	Selects the LFO Waveform
f	[P]Manual	0...100	Sets the frequency to which the effect is applied
	Depth	0...100	Sets the depth of LFO modulation
	Resonance	-100...+100	Sets the resonance amount
g	[P]Phaser Wet/Dry	-Wet, -1:99... Dry...99:1, Wet	Sets the phaser effect balance
	Src	Off...Tempo	Selects the Wet/Dry modulation source for the phaser
	Amt	-100...+100	Sets the Wet/Dry modulation amount for the phaser
h	[P]Output Mode	Normal, Wet Invert	Selects the phaser output mode

i	Wet/Dry	Dry, 1:99...99:1, Wet	Balance between the wet and dry signal
	Src	Off...Tempo	See the list of DMS (Dynamic Modulation Sources) at the beginning of this part
	Amt	-100...+100	Amount of modulation source

Exciter + Multitap Delay

This effect combines a mono exciter and a multitap delay.

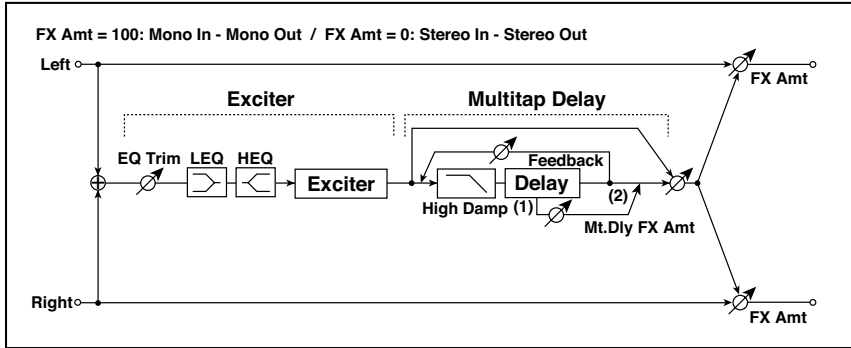

EXCITER

a	[X]Exciter Blend	-100...+100	Sets the intensity (depth) of the Exciter effect
b	[X]Emphasis Frequency	0...70	Sets the frequency range to be emphasized
c	[X]Trim	0...100	Sets the EQ input level
d	[X]Pre LEQ Gain [dB]	-15...+15	Sets the gain of Low EQ
	Pre HEQ Gain [dB]	-15...+15	Sets the gain of High EQ

MULTITAP DELAY

e	[D]Tap1 Time [msec]	0.0...1360.0	Sets the Tap1 delay time
	Tap1 Level	0...100	Sets the Tap1 output level
f	[D]Tap2 Time [msec]	0.0...1360.0	Sets the Tap2 delay time
	Feedback (Tap2)	-100...+100	Sets the Tap2 feedback amount
g	[D]High Damp [%]	0...100	Sets the damping amount in the high range
h	[D]Mt.Delay Wet/Dry	Dry, 1:99...99:1, Wet	Sets the multitap delay effect balance
	Src	Off...Tempo	Selects the Wet/Dry modulation source for the multitap delay
	Amt	-100...+100	Sets the Wet/Dry modulation amount for the multitap delay
i	Wet/Dry	Dry, 1:99...99:1, Wet	Balance between the wet and dry signal
	Src	Off...Tempo	See the list of DMS (Dynamic Modulation Sources) at the beginning of this part
	Amt	-100...+100	Amount of modulation source

OD/HG + Cho/FIng

This effect combines a mono overdrive/high-gain distortion and a chorus/flanger. You can change the order of the effects.

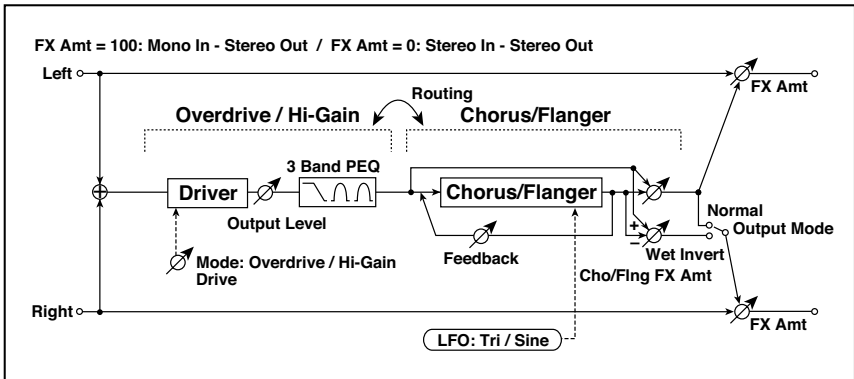

OD/HI-GAIN

a	[O] Drive Mode	Overdrive, Hi-Gain	Switches between overdrive and high-gain distortion
	Drive	1...100	Sets the degree of distortion
b	[O] Output Level	0...50	Sets the overdrive output level
	Src	Off...Tempo	Selects the modulation source for the overdrive output level
	Amt	-50...+50	Sets the modulation amount of the overdrive output level
e	[O] Low Cutoff [Hz]	20...1.00k	Sets the center frequency for Low EQ (shelving type)
	Gain [dB]	-18...+18	Sets the gain of Low EQ
f	[O] Mid1 Cutoff [Hz]	300...10.00k	Sets the center frequency for Mid/High EQ 1 (peaking type)
	Q	0.5...10.0	Sets the band width of Mid/High EQ 1
	Gain [dB]	-18...+18	Sets the gain of Mid/High EQ 1
g	[O] Mid2 Cutoff [Hz]	500...20.00k	Sets the center frequency for Mid/High EQ 2 (peaking type)
	Q	0.5...10.0	Sets the band width of Mid/High EQ 2
	Gain [dB]	-18...+18	Sets the gain of Mid/High EQ 2

CHORUS/FLANGER

h	[F]LFO Frequency [Hz]	0.02...20.00	Sets the speed of the LFO
	LFO Waveform	Triangle, Sine	Selects the LFO Waveform
i	[F]Delay Time [msec]	0.0...1350.0	Sets the delay time
	Depth	0...100	Sets the depth of LFO modulation
	Feedback	-100...+100	Sets the feedback amount
j	[F]Cho/Flng Wet/Dry	-Wet, -1:99... Dry...99:1, Wet	Sets the effect balance of the chorus/flanger
	Src	Off...Tempo	Selects the Wet/Dry modulation source for the chorus/flanger
	Amt	-100...+100	Sets the Wet/Dry modulation amount for the chorus/flanger
k	[F]Output Mode	Normal, Wet Invert	Selects the output mode for the chorus/flanger
	Routing	OD/HG › Flanger, Flanger › OD/HG	Switches the order of the overdrive and chorus / flanger
l	Wet/Dry	Dry, 1:99...99:1, Wet	Balance between the wet and dry signal
	Src	Off...Tempo	See the list of DMS (Dynamic Modulation Sources) at the beginning of this part
	Amt	-100...+100	Amount of modulation source

OD/HG + Phaser

This effect combines a mono overdrive/high-gain distortion and a phaser. You can change the order of the effects.

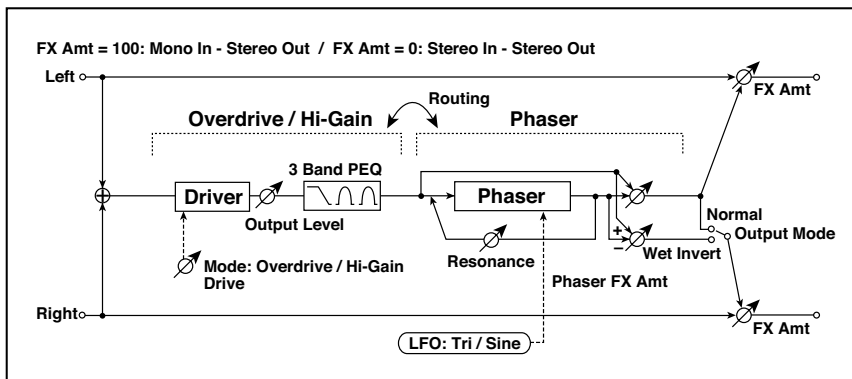

OD/HI-GAIN

a	[O] Drive Mode	Overdrive, Hi-Gain	Switches between overdrive and high-gain distortion
	Drive	1...100	Sets the degree of distortion
b	[O] Output Level	0...50	Sets the overdrive output level
	Src	Off...Tempo	Selects the modulation source for the overdrive output level
	Amt	-50...+50	Sets the modulation amount of the overdrive output level
e	[O] Low Cutoff [Hz]	20...1.00k	Sets the center frequency for Low EQ (shelving type)
	Gain [dB]	-18...+18	Sets the gain of Low EQ
f	[O] Mid1 Cutoff [Hz]	300...10.00k	Sets the center frequency for Mid/High EQ 1 (peaking type)
	Q	0.5...10.0	Sets the band width of Mid/High EQ 1
	Gain [dB]	-18...+18	Sets the gain of Mid/High EQ 1
g	[O] Mid2 Cutoff [Hz]	500...20.00k	Sets the center frequency for Mid/High EQ 2 (peaking type)
	Q	0.5...10.0	Sets the band width of Mid/High EQ 2
	Gain [dB]	-18...+18	Sets the gain of Mid/High EQ 2

PHASER

h	[P]LFO Frequency [Hz]	0.02...20.00	Sets the speed of the LFO
	LFO Waveform	Triangle, Sine	Selects the LFO Waveform
i	[P]Manual	0...100	Sets the frequency to which the effect is applied
	Depth	0..100	Sets the depth of LFO modulation
	Resonance	-100...+100	Sets the resonance amount
j	[P]Phaser Wet/Dry	-Wet, -1:99... Dry...99:1, Wet	Sets the phaser effect balance
	Src	Off...Tempo	Selects the Wet/Dry modulation source for the phaser
	Amt	-100...+100	Sets the Wet/Dry modulation amount for the phaser
k	[P]Output Mode	Normal, Wet Invert	Selects the phaser output mode
	Routing	OD/HG > Phaser, Phaser > OD/HG	Switches the order of the overdrive and phaser
l	Wet/Dry	Dry, 1:99...99:1, Wet	Balance between the wet and dry signal
	Src	Off...Tempo	See the list of DMS (Dynamic Modulation Sources) at the beginning of this part
	Amt	-100...+100	Amount of modulation source

OD/HG + Mt.Delay

This effect combines a mono overdrive/high-gain distortion and a multitap delay.

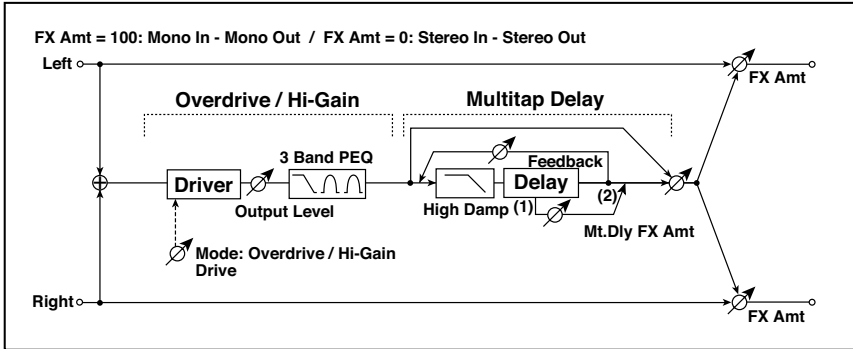

OD/HI-GAIN

a	[O]Drive Mode	Overdrive, Hi-Gain	Switches between overdrive and high-gain distortion
	Drive	1...100	Sets the degree of distortion
b	[O]Output Level	0...50	Sets the overdrive output level
	Src	Off...Tempo	Selects the modulation source for the overdrive output level
	Amt	-50...+50	Sets the modulation amount of the overdrive output level
e	[O]Low Cutoff [Hz]	20...1.00k	Sets the center frequency for Low EQ (shelving type)
	Gain [dB]	-18...+18	Sets the gain of Low EQ
f	[O]Mid1 Cutoff [Hz]	300...10.00k	Sets the center frequency for Mid/High EQ 1 (peaking type)
	Q	0.5...10.0	Sets the band width of Mid/High EQ 1
	Gain [dB]	-18...+18	Sets the gain of Mid/High EQ 1
g	[O]Mid2 Cutoff [Hz]	500...20.00k	Sets the center frequency for Mid/High EQ 2 (peaking type)
	Q	0.5...10.0	Sets the band width of Mid/High EQ 2
	Gain [dB]	-18...+18	Sets the gain of Mid/High EQ 2

MULTITAP DELAY

h	[D]Tap1 Time [msec]	0.0...1360.0	Sets the Tap1 delay time
	Tap1 Level	0...100	Sets the Tap1 output level
i	[D]Tap2 Time [msec]	0.0...1360.0	Sets the Tap2 delay time
	Feedback	-100...+100	Sets the Tap2 feedback amount
j	[D]High Damp [%]	0...100	Sets the damping amount in the high range
k	[D]Mt.Delay Wet/Dry	Dry, 1:99...99:1, Wet	Sets the multitap delay effect balance
	Src	Off...Tempo	Selects the Wet/Dry modulation source for the multitap delay
	Amt	-100...+100	Sets the Wet/Dry modulation amount for the multitap delay
l	Wet/Dry	Dry, 1:99...99:1, Wet	Balance between the wet and dry signal
	Src	Off...Tempo	See the list of DMS (Dynamic Modulation Sources) at the beginning of this part
	Amt	-100...+100	Amount of modulation source

Decimator + Compressor

This effect combines a mono decimator and a compressor. You can change the order of the effects.

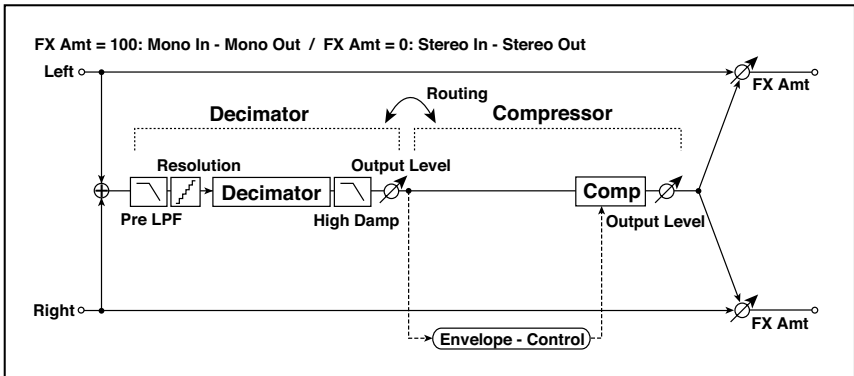

DECIMATOR

a	[D]Pre LPF	Off, On	Turn the harmonic noise caused by lowered sampling on and off
	High Damp [%]	0...100	Sets the ratio of high-range damping
b	[D]Sampling Freq [Hz]	1.00k...48.00k	Sets the sampling frequency
	Resolution	4...24	Sets the data bit length
c	[D]Output Level	0...100	Sets the decimator output level

COMPRESSOR

d	[C] Sensitivity	1...100	Sets the sensitivity
e	[C]Attack	1...100	Sets the attack level
	Output Level	0...100	Sets the compressor output level
f	Routing	Decimator > Comp, Comp > Decimator	Switches the order of the decimator and compressor
g	Wet/Dry	Dry, 1:99...99:1, Wet	Balance between the wet and dry signal
	Src	Off...Tempo	See the list of DMS (Dynamic Modulation Sources) at the beginning of this part
	Amt	-100...+100	Amount of modulation source

Chor/Flang + Multitap Delay

This effect combines a mono chorus/flanger and a multitap delay.

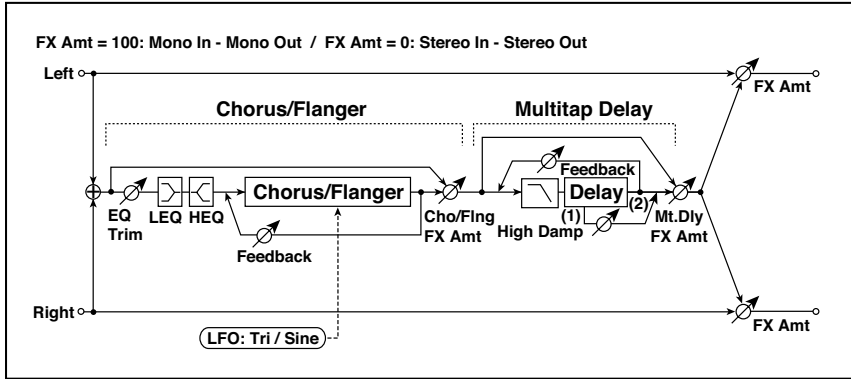

CHORUS/FLANGER

a	[F]LFO Frequency [Hz]	0.02...20.00	Sets the speed of the LFO
	LFO Waveform	Triangle, Sine	Selects the LFO Waveform
b	[F]Delay Time [msec]	0.0...1350.0	Sets the delay time
	Depth	0...100	Sets the depth of LFO modulation
	Feedback	-100...+100	Sets the feedback amount
c	[F]EQ Trim	0...100	Sets the EQ input level
d	[F]PreLEQ Gain [dB]	-15...+15	Sets the gain of Low EQ
	PreHEQ Gain [dB]	-15...+15	Sets the gain of High EQ
e	[F]Cho/Flng Wet/Dry	-Wet...-1 : 99, Dry, 1 : 99...Wet	Sets the effect balance of the chorus/flanger

MULTITAP DELAY

f	[D]Tap1 Time [msec]	0.0...1360.0	Sets the Tap1 delay time
	Tap1 Level	0...100	Sets the Tap1 output level
g	[D]Tap2 Time [msec]	0.0...1360.0	Sets the Tap2 delay time
	Feedback	-100...+100	Sets the Tap2 feedback amount
h	[D]High Damp [%]	0...100	Sets the damping amount in the high range

i	[D]Mt.DelayWet/Dry	Dry, 1:99...99:1, Wet	Sets the multitap delay effect balance
	Src	Off...Tempo	Selects the Wet/Dry modulation source for the multitap delay
	Amt	-100...+100	Sets the Wet/Dry modulation amount for the multitap delay
j	Wet/Dry	Dry, 1:99...99:1, Wet	Balance between the wet and dry signal
	Src	Off...Tempo	See the list of DMS (Dynamic Modulation Sources) at the beginning of this part
	Amt	-100...+100	Amount of modulation source

PianoBody / Damper

This effect simulates the resonance of the piano sound board caused by the string vibration, and also simulates the resonance of other strings that are not being played when you press the damper pedal. It will create a very realistic sound when applied to acoustic piano sounds.

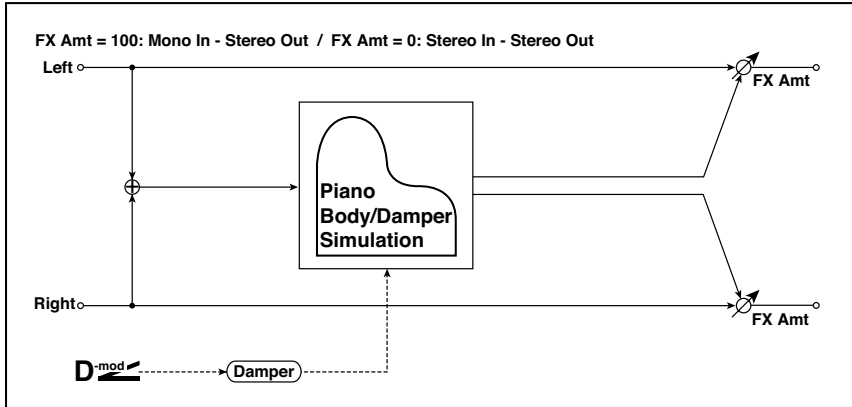

a	Sound Board Depth	0...100	Sets the intensity of resonance of the sound board
b	Damper Depth	0...100	Sets the intensity of the string resonance created when the damper pedal is pressed
	Src	Off...Tempo	Selects the modulation source of damper effect
c	Tone	1...100	Sets tonal quality of effect sound
d	Mid Shape	0...36	Sets the mid range of tonal quality
e	Tune	-50...+50	Fine tuning
f	Wet/Dry	Dry, 1:99...99:1, Wet	Balance between the wet and dry signal
	Src	Off...Tempo	See the list of DMS (Dynamic Modulation Sources) at the beginning of this part
	Amt	-100...+100	Amount of modulation source

- **a: Sound Board Depth**

This parameter sets the intensity of resonance of the piano sound board.

- **b: Damper Depth**

- **b: Src**

This parameter sets the resonance intensity of the other strings created when the damper pedal is pressed. The “Src” parameter selects the modulation source from which the damper effect is applied. Usually, select Damper #64 Pdl (Damper pedal).

MIDI The effect is off when a value for the modulation source specified for the “Src” parameter is 63 or smaller, and the effect is on when the value is 64 or higher.

- **c: Tone**

- **d: Mid Shape**

These parameters control the tonal quality of the effect sound.

- **e: Tune**

Since this effect simulates the resonance of the strings, the sound varies depending on the pitch. If you have changed tuning using the “Master Tuning” (Global > General Controls > Basic), adjust this parameter value.

Multitap Chorus/Delay

This effect has six chorus blocks with different LFO phases. You can produce a complex stereo image by setting a different delay time and depth for each block. You can control the delay output level via a modulation source.

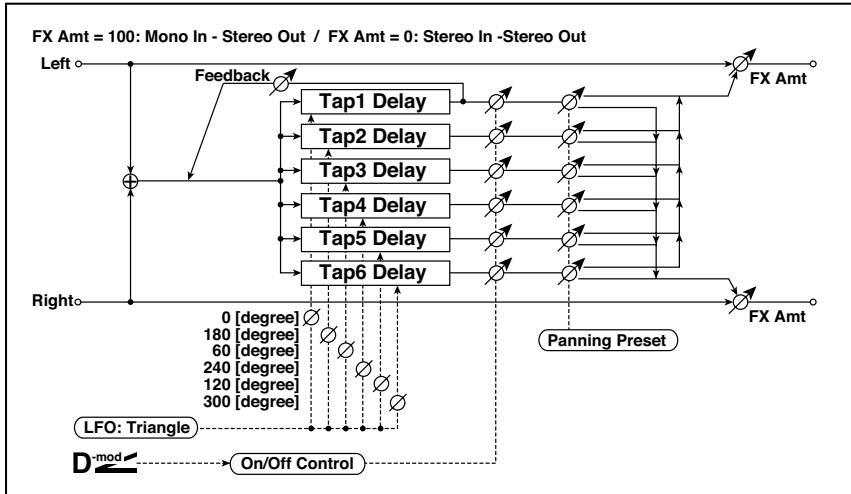

a	LFO Frequency [Hz]	0.02...13.00	Sets the speed of the LFO
b	Tap1 (000) [msec]	0...2000	Sets the Tap1 (LFO phase=0 degrees) delay time
	Depth	0...30	Sets the Tap1 chorus depth
	Status	Always On, Always Off, On>Off (Dm), Off>On (Dm)	Selects on, off, or modulation source for the control of Tap1 output
	c	Tap2 (180) [msec]	0...2000
d	Depth	0...30	Sets the Tap2 chorus depth
	Status	Always On, Always Off, On>Off (Dm), Off>On (Dm)	Selects on, off, or modulation source for the control of Tap2 output
	d	Tap3 (060) [msec]	0...2000
e	Depth	0...30	Sets the Tap3 chorus depth
	Status	Always On, Always Off, On>Off (Dm), Off>On (Dm)	Selects on, off, or modulation source for the control of Tap3 output

e	Tap4 (240) [msec]	0...2000	Sets the Tap4 (LFO phase=240 degrees) delay time
	Depth	0...30	Sets the Tap4 chorus depth
	Status	Always On, Always Off, On>Off (Dm), Off>On (Dm)	Selects on, off, or modulation source for the control of Tap4 output
f	Tap5 (120) [msec]	0...2000	Sets the Tap5 (LFO phase=120 degrees) delay time
	Depth	0...30	Sets the Tap5 chorus depth
	Status	Always On, Always Off, On>Off (Dm), Off>On (Dm)	Selects on, off, or modulation source for the control of Tap5 output
g	Tap6 (300) [msec]	0...2000	Sets the Tap1 (LFO phase=300 degrees) delay time
	Depth	0...30	Sets the Tap6 chorus depth
	Status	Always On, Always Off, On>Off (Dm), Off>On (Dm)	Selects on, off, or modulation source for the control of Tap6 output
h	Panning Preset	1 : L 1 2 3 4 5 6 R, 2 : L 135 246 R, 3 : L 1 3 5 2 4 6 R, 4 : L 1 4 5 6 3 2 R	Selects the stereo panning pattern for each tap
i	Tap1 Feedback	-100...+100	Sets the Tap1 feedback amount
	Src	Off...Tempo	Selects the modulation source for the Tap output level, feedback amount, and effect balance
	Amt	-100...+100	Sets the modulation amount of Tap1 feedback amount
j	Wet/Dry	Dry, 1:99...99:1, Wet	Balance between the wet and dry signal
	Src	Off...Tempo	See the list of DMS (Dynamic Modulation Sources) at the beginning of this part
	Amt	-100...+100	Amount of modulation source

■ b, c, d, e, f, g: Status

These parameters set the output status of each Tap.

Always On: Output is always on. (No modulation)

Always Off: Output is always off. (No modulation)

On/Off (dm): Output level is switched from on to off depending on the modulation source.

Off/On (dm): Output level is switched from off to on depending on the modulation source.

Combining these parameters, you can change from 4-phase chorus to two-tap delay by crossfading them gradually via the modulation source during a performance.

■ **h: Panning Preset**

This parameter selects combinations of stereo images of the tap outputs.

Stereo Limiter+6BandEQ

This is the same as the **Limiter + P4EQ** effect, but with with the addition of a high-pass and a low-pass filter (see **Limiter + P4EQ** on page 1210).

Modulator

Stereo Chorus

This effect adds thickness and warmth to the sound by modulating the delay time of the input signal. You can add spread to the sound by offsetting the phase of the left and right LFOs from each other.

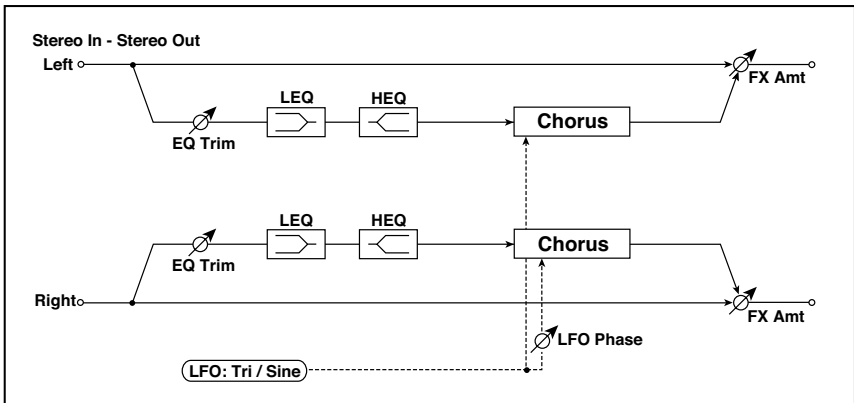

a	LFO Waveform	Triangle, Sine	Selects the LFO Waveform
	LFO Phase [degree]	-180...+180	Sets the LFO phase difference between the left and right
b	LFO Frequency [Hz]	0.02...20.00	Sets the speed of the LFO
	Src	Off...Tempo	Selects a modulation source for LFO speed
	Amt	-20.00... +20.00	Sets the modulation amount of LFO speed
c	MIDI Sync	Off, On	When this is on, the LFO speed is set by BPM, Base Note, and Times, instead of Frequency
	BPM	MIDI, 40.00... 300.00	MIDI syncs to the system tempo; 40–300 sets the tempo manually for this individual effect
	Base Note		Selects the type of notes that specify the LFO speed
	Times	x1...x32	Sets the number of notes that specify the LFO speed
	d	L Pre Delay [msec]	0.0...50.0
	R Pre Delay [msec]	0.0...50.0	Sets the delay time for the right channel

e	Depth	0...100	Sets the depth of LFO modulation
	Src	Off...Tempo	Selects the modulation source for the LFO modulation depth
	Amt	-100...+100	Sets the modulation amount of the LFO modulation depth
f	EQ Trim	0...100	Sets the EQ input level
g	Pre LEQ Fc	Low, Mid-Low	Selects the cutoff frequency (low or mid-low) of the low-range equalizer
	Pre HEQ Fc	High, Mid-High	Selects the cutoff frequency (high or mid-high) of the high-range equalizer
h	Pre LEQ Gain [dB]	-15.0...+15.0	Gain of the Low EQ
	Pre HEQ Gain [dB]	-15.0...+15.0	Gain of the High EQ
i	Wet/Dry	-Wet, -1:99... Dry...99:1, Wet	Balance between the wet and dry signal
	Src	Off...Tempo	See the list of DMS (Dynamic Modulation Sources) at the beginning of this part
	Amt	-100...+100	Amount of modulation source

- **d: L Pre Delay [msec]**

- **d: R Pre Delay [msec]**

Setting the left and right delay time individually allows you to control the stereo image.

Stereo Harmonic Chorus

This effect applies chorus only to higher frequencies. This can be used to apply a chorus effect to a bass sound without making the sound thinner. You can also use this chorus block with feedback as a flanger.

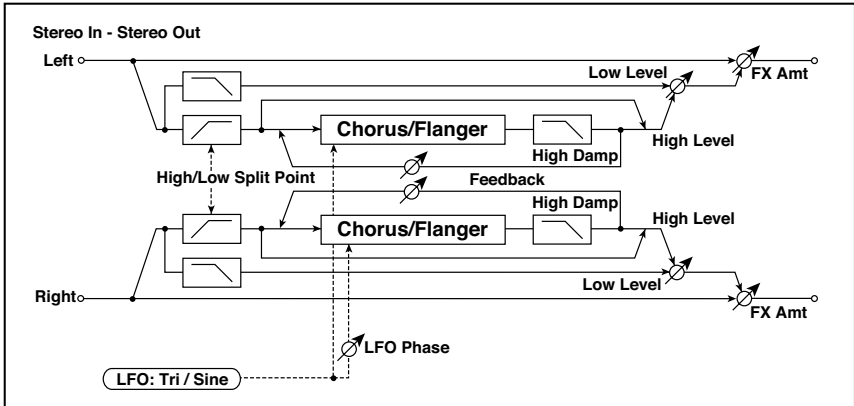

a	LFO Waveform	Triangle, Sine	Selects the LFO Waveform
	LFO Phase [degree]	-180...+180	Sets the LFO phase difference between the left and right
b	LFO Frequency [Hz]	0.02...20.00	Sets the speed of the LFO
	Src	Off...Tempo	Selects a modulation source for LFO speed
	Amt	-20.00...+20.00	Sets the modulation amount of LFO speed
c	MIDI Sync	Off, On	When this is on, the LFO speed is set by BPM, Base Note, and Times, instead of Frequency
	BPM	MIDI, 40.00...300.00	MIDI syncs to the system tempo; 40-300 sets the tempo manually for this individual effect
	Base Note		Selects the type of notes that specify the LFO speed
	Times	x1...x32	Sets the number of notes that specify the LFO speed
d	Pre Delay [msec]	0.0...50.0	Sets the delay time from the original sound
e	Depth	0...100	Sets the depth of LFO modulation
	Src	Off...Tempo	Selects the modulation source of the LFO modulation depth
	Amt	-100...+100	Sets the modulation amount of the LFO modulation depth

f	High/Low Split Point	1...100	Sets the frequency split point between the low and high range
g	Feedback	-100...+100	Sets the feed back amount of the chorus block
	High Damp [%]	0...100	Sets the high range damping amount of the chorus block
h	Low Level	0...100	Sets the low range output level
	High Level	0...100	Sets the high range (chorus) output level
i	Wet/Dry	Dry, 1:99...99:1, Wet	Balance between the wet and dry signal
	Src	Off...Tempo	See the list of DMS (Dynamic Modulation Sources) at the beginning of this part
	Amt	-100...+100	Amount of modulation source

■ f: High/Low Split Point

This parameter sets the frequency that splits the high and low range. Only the high range will be sent to the chorus block.

■ g: Feedback

Sets the feedback amount of the chorus block. Increasing the feedback will allow you to use the effect as a flanger.

Stereo Biphase Mod

This stereo chorus effect adds two different LFOs together. You can set the Frequency and Depth parameters for each LFO individually. Depending on the setting of these LFOs, very complex waveforms will create an analog-type, unstable modulated sound.

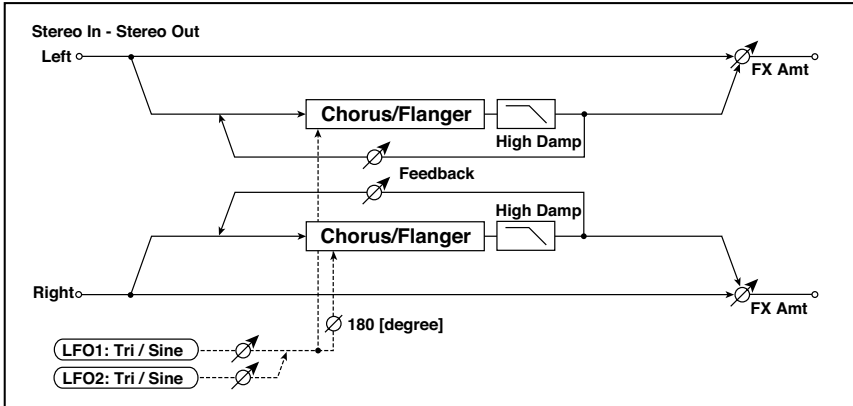

a	LFO1 Waveform	Triangle, Sine	Selects LFO1 waveform
	LFO2	Triangle, Sine	Selects LFO2 waveform
	Phase Sw	0 deg, 180 deg	Switches the LFO phase difference between left and right
b	LFO1 Frequency [Hz]	0.02...30.00	Sets the LFO1 speed
	Src	Off...Tempo	Selects the modulation source of LFO1&2 speed
	LFO1 Amt	-30.00... +30.00	Sets the modulation amount of LFO1 speed
c	LFO2 Frequency [Hz]	0.02...30.00	Sets the LFO2 speed
	Amt	-30.00... +30.00	Sets the modulation amount of LFO2 speed
d	Depth1	0...100	Sets the depth of LFO1 modulation
	Src	Off...Tempo	Selects the modulation source of LFO1&2 modulation depth
	Amt	-100...+100	Sets the modulation amount of LFO1 modulation depth

e	Depth2	0...100	Sets the depth of LFO2 modulation
	Amt	-100...+100	Sets the modulation amount of LFO2 modulation depth
f	L Pre Delay [msec]	0.0...50.0	Sets the delay time for the left channel
	R Pre Delay [msec]	0.0...50.0	Sets the delay time for the right channel
g	Feedback	-100...+100	Sets the feedback amount
	High Damp [%]	0...100	Sets the damping amount in the high range
h	Wet/Dry	-Wet, -1:99... Dry...99:1, Wet	Balance between the wet and dry signal
	Src	Off...Tempo	See the list of DMS (Dynamic Modulation Sources) at the beginning of this part
	Amt	-100...+100	Amount of modulation source

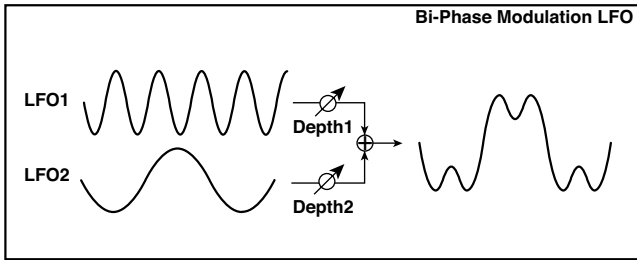

Multitap Chorus / Delay

This effect has four chorus blocks with a different LFO phase. You can create a complex stereo image by setting each block's delay time, depth, output level, and pan individually. You can also fix some of the chorus blocks to combine the chorus and delay effects.

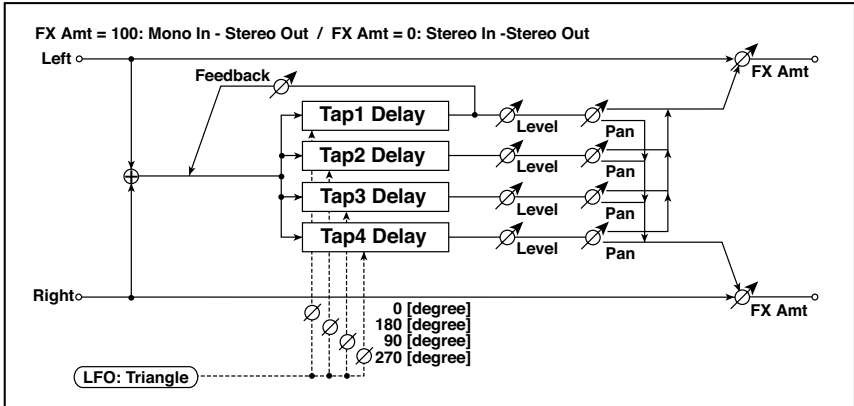

a	LFO Frequency [Hz]	0.02...13.00	Sets the speed of the LFO
b	Tap1 (000) [msec]	0...1000	Sets the Tap1 (LFO phase=0 degrees) delay time
	Depth	0...30	Sets the Tap1 chorus depth
	Level	0...30	Sets the Tap1 output level
	Pan	L6...L1, C, R1...R6	Sets the Tap1 stereo image
c	Tap2 (180) [msec]	0...1000	Sets the Tap2 (LFO phase=180 degrees) delay time
	Depth	0...30	Sets the Tap2 chorus depth
	Level	0...30	Sets the Tap2 output level
	Pan	L6...L1, C, R1...R6	Sets the Tap2 stereo image
d	Tap3 (090) [msec]	0...1000	Sets the Tap3 (LFO phase=90 degrees) delay time
	Depth	0...30	Sets the Tap3 chorus depth
	Level	0...30	Sets the Tap3 output level
	Pan	L6...L1, C, R1...R6	Sets the Tap3 stereo image

e	Tap4 (270) [msec]	0...1000	Sets the Tap4 (LFO phase=270 degrees) delay time
	Depth	0...30	Sets the Tap4 chorus depth
	Level	0...30	Sets the Tap4 output level
	Pan	L6...L1, C, R1...R6	Sets the Tap4 stereo image
f	Tap1 Feedback	-100...+100	Sets the Tap1 feedback amount
	Src	Off...Tempo	Selects the modulation source of Tap1 feedback amount and effect balance
	Amt	-100...+100	Sets the Tap1 feedback amount and modulation amount
g	Wet/Dry	Dry, 1:99...99:1, Wet	Balance between the wet and dry signal
	Src	Off...Tempo	See the list of DMS (Dynamic Modulation Sources) at the beginning of this part
	Amt	-100...+100	Amount of modulation source

Ensemble

This Ensemble effect has three chorus blocks that use LFO to create subtle shimmering, and gives three dimensional depth and spread to the sound, because the signal is output from the left, right, and center.

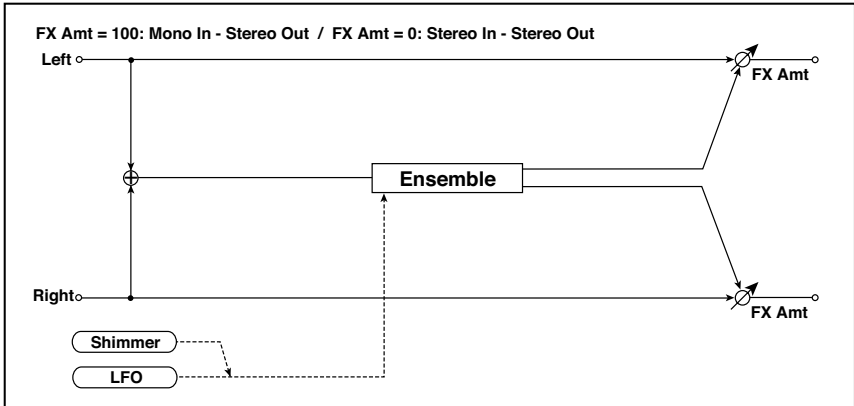

a	Speed [Hz]	1...100	Sets the speed of the LFO
	Src	Off...Tempo	Selects a modulation source for LFO speed
	Amt	-100...+100	Sets the modulation amount of LFO speed
b	Depth	0...100	Sets the depth of LFO modulation
	Src	Off...Tempo	Selects the modulation source of the LFO modulation depth
	Amt	-100...+100	Sets the modulation amount of the LFO modulation depth
c	Shimmer	0...100	Sets the amount of shimmering of the LFO waveform
d	Wet/Dry	Dry, 1:99...99:1, Wet	Balance between the wet and dry signal
	Src	Off...Tempo	See the list of DMS (Dynamic Modulation Sources) at the beginning of this part
	Amt	-100...+100	Amount of modulation source

■ c: Shimmer

This parameter sets the amount of shimmering of the LFO waveform. Increasing this value adds more shimmering, making the chorus effect more complex and richer.

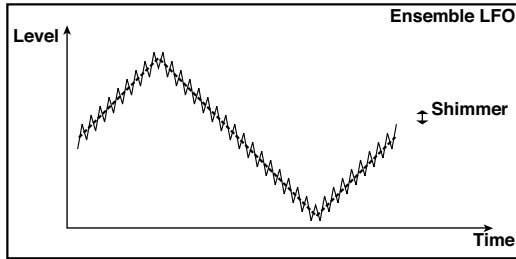

Polysix Ensemble

This models the ensemble effect built into the classic KORG PolySix programmable polyphonic synthesizer.

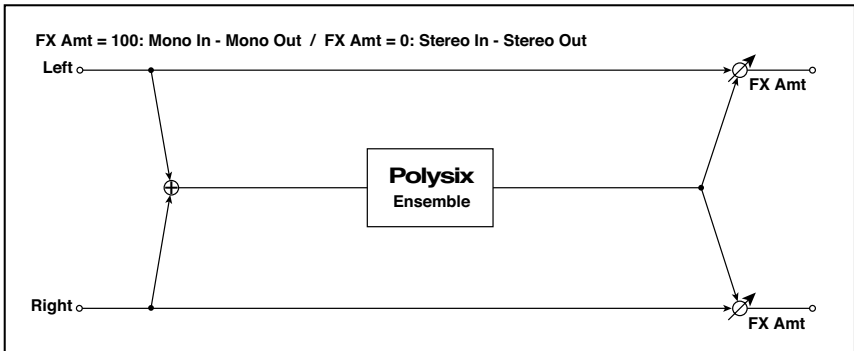

a	Depth	0...100	Sets the depth of the effect
	Src	Off...Tempo	Selects the modulation source that will control the effect depth
	Amt	-100...+100	Sets the amount by which the effect depth will be modulated
b	Wet/Dry	Dry, 1:99...99:1, Wet	Balance between the wet and dry signal
	Src	Off...Tempo	See the list of DMS (Dynamic Modulation Sources) at the beginning of this part
	Amt	-100...+100	Amount of modulation source

Stereo Flanger

This effect gives a significant swell and movement of pitch to the sound. It is more effective when applied to a sound with a lot of harmonics. This is a stereo flanger. You can add spread to the sound by offsetting the phase of the left and right LFOs from each other.

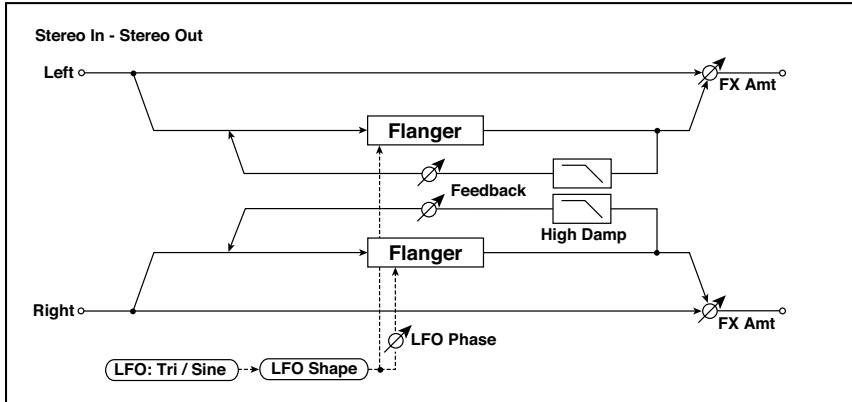

a	Delay Time [msec]	0.0...50.0	Sets the delay time from the original sound
b	LFO Waveform	Triangle, Sine	Selects the LFO Waveform
	LFO Shape	-100...+100	Changes the curvature of the LFO Waveform
c	LFO Phase [degree]	-180...+180	Sets the LFO phase difference between the left and right
d	LFO Frequency [Hz]	0.02...20.00	Sets the speed of the LFO
	Src	Off...Tempo	Selects a modulation source for LFO speed
	Amt	-20.00...+20.00	Sets the modulation amount of LFO speed
e	MIDI Sync	Off, On	When this is on, the LFO speed is set by BPM, Base Note, and Times, instead of Frequency
	BPM	MIDI, 40.00...300.00	MIDI syncs to the system tempo; 40-300 sets the tempo manually for this individual effect
	Base Note		Selects the type of notes that specify the LFO speed
	Times	x1...x32	Sets the number of notes that specify the LFO speed
f	Depth	0...100	Sets the depth of LFO modulation

g	Feedback	-100...+100	Sets the feedback amount
	High Damp [%]	0...100	Sets the feedback damping amount in the high range
h	Wet/Dry	-Wet, -1:99... Dry...99:1, Wet	Balance between the wet and dry signal
	Src	Off...Tempo	See the list of DMS (Dynamic Modulation Sources) at the beginning of this part
	Amt	-100...+100	Amount of modulation source

■ g: Feedback

■ h: Wet/Dry

The peak shape of the positive and negative “Feedback” value is different. The harmonics will be emphasized when the effect sound is mixed with the dry sound if you set a positive value for both “Feedback” and “Wet/Dry”, and if you set a negative value for both “Feedback” and “Wet/Dry”.



■ g: High Damp [%]

This parameter sets the amount of damping of the feedback in the high range. Increasing the value will cut high-range harmonics.

Stereo Random Flanger

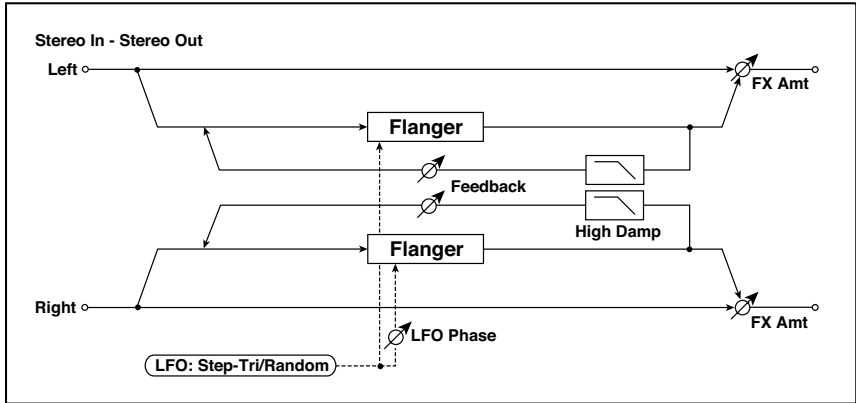
The stereo effect uses a step-shape waveform and random LFO for modulation, creating a unique flanging effect.



a	Delay Time [msec]	0.0...50.0	Sets the delay time from the original sound
b	LFO Waveform	Step-Tri, Random	Selects the LFO Waveform
	LFO Phase [degree]	-180...+180	Sets the LFO phase difference between the left and right
c	LFO Frequency [Hz]	0.02...20.00	Sets the speed of the LFO
	Src	Off...Tempo	Selects the modulation source used for both LFO speed and step speed
	Amt	-20.00... +20.00	Sets the modulation amount of LFO speed
d	LFO Step Freq [Hz]	0.05...50.00	Sets the LFO step speed (speed that changes in steps)
	Step Amt	-50.00... +50.00	Sets the modulation amount of LFO step speed
e	MIDI Sync	Off, On	When this is on, the LFO speed is set by BPM, Base Note, and Times, instead of Frequency
	BPM	MIDI, 40.00... 300.00	MIDI syncs to the system tempo; 40-300 sets the tempo manually for this individual effect
	Base Note		Selects the type of notes that specify the LFO speed
	Times	x1...x32	Selects the number of notes that specify the LFO speed
f	Step Base Note		Selects the type of notes to specify the LFO step speed
	Times	x1...x32	Selects the number of notes to specify the LFO step speed
g	Depth	0...100	Sets the depth of LFO modulation
h	Feedback	-100...+100	Sets the feedback amount
	High Damp [%]	0...100	Sets the feedback damping amount in the high range
i	Wet/Dry	-Wet, -1:99... Dry...99:1, Wet	Balance between the wet and dry signal
	Src	Off...Tempo	See the list of DMS (Dynamic Modulation Sources) at the beginning of this part
	Amt	-100...+100	Amount of modulation source

Stereo Envelope Flanger

This Flanger uses an envelope generator for modulation. You will obtain the same pattern of flanging each time you play. You can also control the Flanger directly using the modulation source.

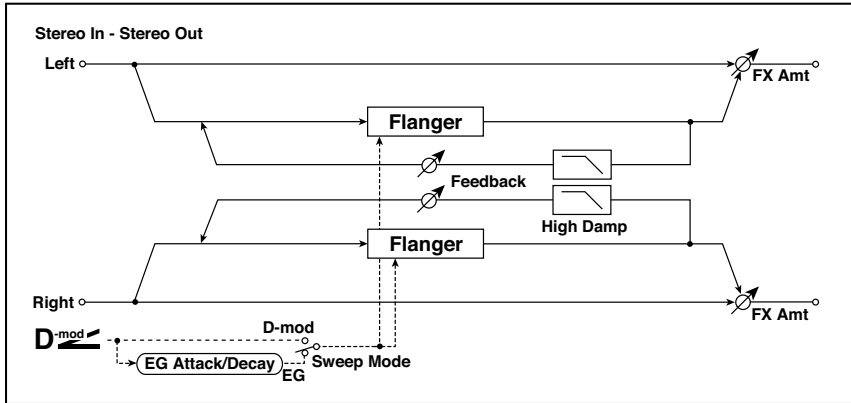

a	L Dly Bottom [msec]	0.0...50.0	Sets the lower limit of the left-channel delay time
	L Dly Top [msec]	0.0...50.0	Sets the upper limit of the left-channel delay time
b	R Dly Bottom [msec]	0.0...50.0	Sets the lower limit of the right-channel delay time
	R Dly Top [msec]	0.0...50.0	Sets the upper limit of the right-channel delay time
c	Sweep Mode	EG, D-mod	Determines whether the flanger is controlled by the envelope generator or by the modulation source
	Src	Off...Tempo	Selects the modulation source that triggers the EG (when Sweep Mode = EG), or the modulation source that causes the flanger to sweep (when Sweep Mode = D-mod)
d	EG Attack	1...100	Sets the EG attack speed
	EG Decay	1...100	Sets the EG decay speed
e	Feedback	-100...+100	Sets the feedback amount
f	High Damp [%]	0...100	Sets the feedback damping amount in the high range

g	Wet/Dry	-Wet, -1:99... Dry...99:1, Wet	Balance between the wet and dry signal
	Src	Off...Tempo	See the list of DMS (Dynamic Modulation Sources) at the beginning of this part
	Amt	-100...+100	Amount of modulation source

■ c: Sweep Mode

■ c: Src

This parameter switches the flanger control mode. With “Sweep Mode” = EG, the flanger will sweep using the envelope generator. This envelope generator is included in the envelope flanger, and not related to the Pitch EG, Filter EG, or Amp EG.

The “Src” parameter selects the source that starts the envelope generator. If you select, for example, Gate, the envelope generator will start when the note-on message is received.

When “Sweep Mode” = D-mod, the modulation source can control the flanger directly. Select the modulation source using the “Src” parameter.

MIDI The effect is off when a value for the modulation source specified for the “Src” parameter is smaller than 64, and the effect is on when the value is 64 or higher. The Envelope Generator is triggered when the value changes from 63 or smaller to 64 or higher.

■ d: EG Attack

■ d: EG Decay

Attack and Decay speed are the only adjustable parameters on this EG.

Stereo Phaser

This effect creates a swell by shifting the phase. It is very effective on electric piano sounds. You can add spread to the sound by offsetting the phase of the left and right LFOs from each other.

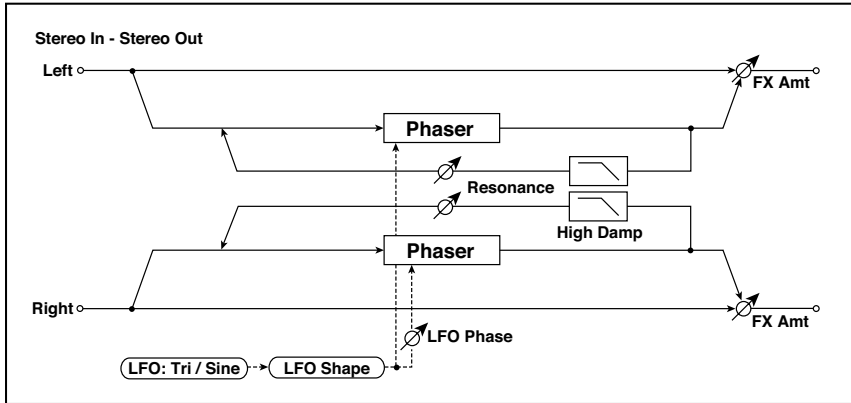

a	LFO Waveform	Triangle, Sine	Selects the LFO Waveform
	LFO Shape	-100...+100	Changes the curvature of the LFO Waveform
b	LFO Phase [degree]	-180...+180	Sets the LFO phase difference between the left and right
c	LFO Frequency [Hz]	0.02...20.00	Sets the speed of the LFO
	Src	Off...Tempo	Selects a modulation source for LFO speed
	Amt	-20.00...+20.00	Sets the modulation amount of LFO speed
d	MIDI Sync	Off, On	When this is on, the LFO speed is set by BPM, Base Note, and Times, instead of Frequency
	BPM	MIDI, 40.00...300.00	MIDI syncs to the system tempo; 40–300 sets the tempo manually for this individual effect
	Base Note		Selects the type of notes that specify the LFO speed
	Times	x1...x32	Sets the number of notes that specify the LFO speed
e	Manual	0...100	Sets the frequency to which the effect is applied
	Src	Off...Tempo	Selects the modulation source for the LFO modulation
	Amt	-100...+100	Sets the modulation amount of the LFO modulation

f	Depth	0...100	Sets the depth of LFO modulation
	Src	Off...Tempo	Selects the modulation source for the LFO modulation depth
	Amt	-100...+100	Sets the modulation amount of the LFO modulation depth
h	Resonance	-100...+100	Sets the resonance amount
	High Damp [%]	0...100	Sets the resonance damping amount in the high range
j	Wet/Dry	-Wet, -1:99... Dry...99:1, Wet	Balance between the wet and dry signal
	Src	Off...Tempo	See the list of DMS (Dynamic Modulation Sources) at the beginning of this part
	Amt	-100...+100	Amount of modulation source

■ h: Resonance

■ i: Wet/Dry

The peak shape of the positive and negative Feedback value is different. The harmonics will be emphasized when the effect sound is mixed with the dry sound, if you set a positive value for both “Resonance” and “Wet/Dry”, and if you set a negative value for both “Resonance” and “Wet/Dry”.

■ h: High Damp [%]

This parameter sets the amount of damping of the resonance in the high range. Increasing the value will cut high-range harmonics.

Stereo Random Phaser

This is a stereo phaser. The effect uses a step-shape waveform and random LFO for modulation, creating a unique phasing effect.

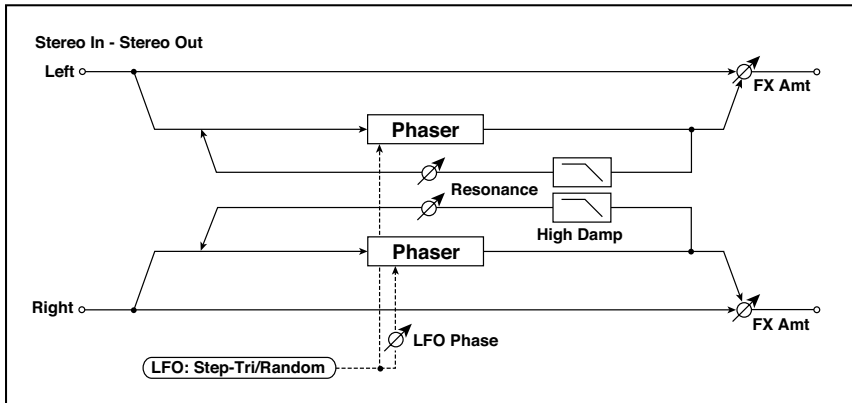

a	LFO Waveform	Step-Tri, Step-Sin, Random	Selects the LFO Waveform
	LFO Phase [degree]	-180...+180	Sets the LFO phase difference between the left and right
b	LFO Frequency [Hz]	0.02...20.00	Sets the speed of the LFO
	Src	Off...Tempo	Selects the modulation source commonly used for LFO speed and step speed
	Amt	-20.00...+20.00	Sets the modulation amount of LFO speed
c	LFO Step Freq [Hz]	0.05...50.00	Sets the LFO step speed
	Amt	-50.00...+50.00	Sets the modulation amount of LFO step speed
d	MIDI Sync	Off, On	When this is on, the LFO speed is set by BPM, Base Note, and Times, instead of Frequency
	BPM	MIDI, 40.00...300.00	MIDI syncs to the system tempo; 40-300 sets the tempo manually for this individual effect
	Base Note		Selects the type of notes that specify the LFO speed
	Times	x1...x32	Sets the number of notes that specify the LFO speed

e	Step Base Note 		Selects the type of notes to specify the LFO step speed
	Times	x1...x32	Sets the number of notes to specify the LFO step speed
f	Manual	0...100	Sets the frequency to which the effect is applied
	Src	Off...Tempo	Selects the modulation source for the LFO modulation
	Amt	-100...+100	Sets the modulation amount of the LFO modulation
g	Depth	0...100	Sets the depth of LFO modulation
h	Resonance	-100...+100	Sets the resonance amount
	High Damp [%]	0...100	Sets the resonance damping amount in the high range
i	Wet/Dry	-Wet, -1:99... Dry...99:1, Wet	Balance between the wet and dry signal
	Src	Off...Tempo	See the list of DMS (Dynamic Modulation Sources) at the beginning of this part
	Amt	-100...+100	Amount of modulation source

Stereo Envelope Phaser

This stereo phaser uses an envelope generator for modulation. You will obtain the same pattern of phasing each time you play. You can also control the Phaser directly using the modulation source.

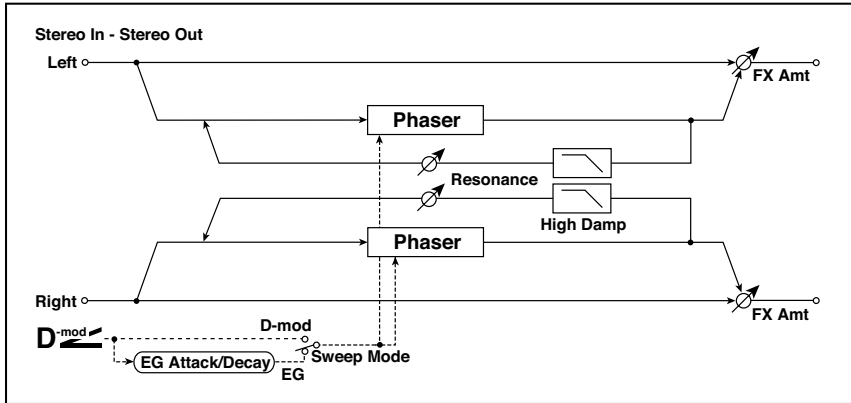



a	L Manu Bottom	0...100	Sets the lower limit of the frequency range for the effect on the left channel
	L Manu Top	0...100	Sets the upper limit of the frequency range for the effect on the left channel
b	R Manu Bottom	0...100	Sets the lower limit of the frequency range for the effect on the right channel
	R Manu Top	0...100	Sets the upper limit of the frequency range for the effect on the right channel
c	Sweep Mode	EG, D-mod	Determines whether the flanger is controlled by the envelope generator or by the modulation source
	Src	Off...Tempo	Selects the modulation source that triggers the EG (when EG is selected for Sweep Mode), or modulation source that causes the flanger to sweep (when D-mod is selected for Sweep Mode). See the list of DMS (Dynamic Modulation Sources) at the beginning of this part
d	EG Attack	1...100	Sets the EG attack speed
	EG Decay	1...100	Sets the EG decay speed
e	Resonance	-100...+100	Sets the resonance amount
f	High Damp [%]	0...100	Sets the resonance damping amount in the high range

g	Wet/Dry	-Wet, -1:99... Dry...99:1, Wet	Balance between the wet and dry signal
	Src	Off...Tempo	See the list of DMS (Dynamic Modulation Sources) at the beginning of this part
	Amt	-100...+100	Amount of modulation source

Stereo Vibrato

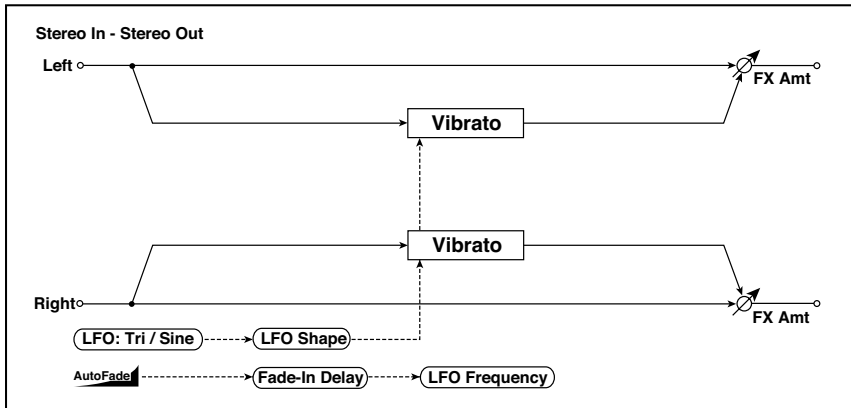
This effect causes the pitch of the input signal to shimmer. Using the AutoFade allows you to increase or decrease the shimmering speed.



a	Autofade Src	Off...Tempo	Selects the modulation source that starts AutoFade
b	Fade-In Delay [msec]	00...2000	Sets the fade-in delay time
	Fade-In Rate	1...100	Sets the rate of fade-in
c	LFO Waveform	Triangle, Sine	Selects the LFO Waveform
	LFO Shape	-100...+100	Changes the curvature of the LFO Waveform
d	LFO Frequency Mod	D-mod, AUTOFADE	Switches between D-mod and AUTOFADE for the LFO frequency modulation
e	LFO Frequency [Hz]	0.02...20.00	Sets the speed of the LFO
	Src	Off...Tempo	Selects a modulation source for LFO speed
	Amt	-20.00... +20.00	Sets the modulation amount of LFO speed
f	MIDI Sync	Off, On	When this is on, the LFO speed is set by BPM, Base Note, and Times, instead of Frequency
	BPM	MIDI, 40.00... 300.00	MIDI syncs to the system tempo; 40-300 sets the tempo manually for this individual effect
	Base Note		Selects the type of notes that specify the LFO speed
	Times	x1...x32	Sets the number of notes that specify the LFO speed

g	Depth	0...100	Sets the depth of LFO modulation
	Src	Off...Tempo	Selects the modulation source of the LFO modulation depth
	Amt	-100...+100	Sets the modulation amount of the LFO modulation depth
h	Wet/Dry	Dry, 1:99...99:1, Wet	Balance between the wet and dry signal
	Src	Off...Tempo	See the list of DMS (Dynamic Modulation Sources) at the beginning of this part
	Amt	-100...+100	Amount of modulation source

- **a: Autofade Src**
- **b: Fade-In Delay [msec]**
- **b: Fade-In Rate**
- **d: LFO Frequency Mod**

When “LFO Frequency Mod” is set to AUTOFADE, you can use the modulation source selected in “AUTOFADE Src” as a trigger to automatically fade in the modulation amount. When “MIDI Sync” is set to On, you cannot use this.

The “Fade-In Rate” parameter specifies the rate of fade-in. The “Fade-In Delay” parameter determines the time from AutoFade modulation source On until the fade-in starts.

The following is an example of fade-in where the LFO speed is increased from “1.0Hz” to “4.0Hz” when a note-on message is received.

AUTOFADE Src=Gate1, LFO Frequency Mod=AUTOFADE, LFO Frequency [Hz]=1.0, Amt=3.0

MIDI The effect is off when a value for the dynamic modulation source specified for the “AUTOFADE Src” parameter is smaller than 64, and the effect is on

when the value is 64 or higher. The AutoFade function is triggered when the value changes from 63 or smaller to 64 or higher.

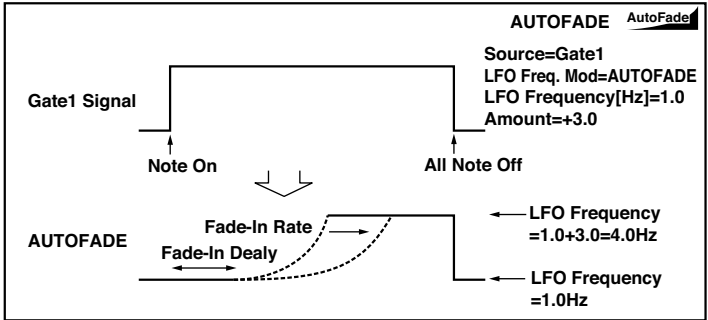

Stereo Auto Fade Mod

This stereo chorus/flanger effect enables you to control the LFO speed and effect balance using auto fade, and you can spread the sound by offsetting the phase of the left and right LFOs from each other.

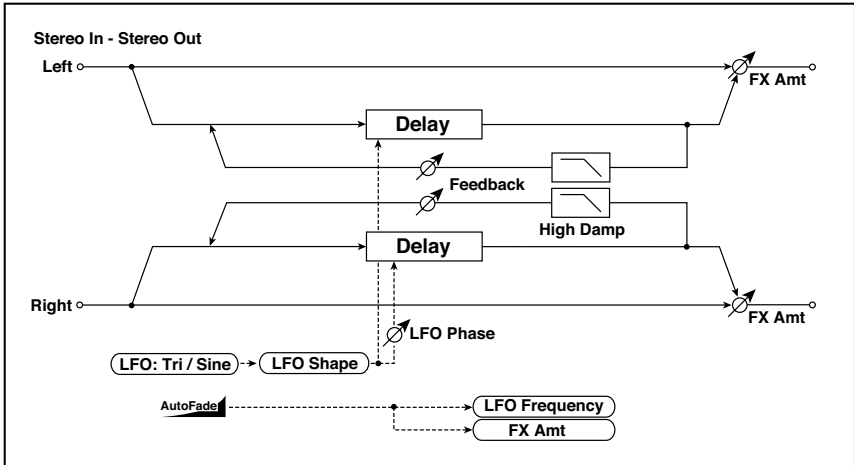

a	Autofade Src	Off...Tempo	Selects the modulation source that starts AutoFade
	Fade-In Delay [msec]	00...2000	Sets the fade-in delay time
	Rate	1...100	Sets the rate of fade-in
b	LFO Frequency Mod	D-mod, AUTOFADE	Switches between D-mod and AUTOFADE for the LFO frequency modulation
	Wet/Dry Mod	D-mod, AUTOFADE	Switches between D-mod and AUTOFADE for the effect balance modulation
c	LFO Waveform	Triangle, Sine	Selects the LFO Waveform
	LFO Shape	-100...+100	Changes the curvature of the LFO Waveform
d	LFO Phase [degree]	-180...+180	Sets the LFO phase difference between the left and right
e	LFO Frequency [Hz]	0.02...20.00	Sets the speed of the LFO
	Src	Off...Tempo	Selects a modulation source for LFO speed
	Amt	-20.00...+20.00	Sets the modulation amount of LFO speed
f	L Delay Time [msec]	0.0...500.0	Sets the left channel delay time
	R Delay Time [msec]	0.0...500.0	Sets the right channel delay time
g	Depth	0...200	Sets the depth of LFO modulation
h	Feedback	-100...+100	Sets the feedback amount
	High Damp [%]	0...100	Sets the feedback damping amount in the high range
i	Wet/Dry	-Wet, -1:99... Dry...99:1, Wet	Balance between the wet and dry signal
	Src	Off...Tempo	See the list of DMS (Dynamic Modulation Sources) at the beginning of this part
	Amt	-100...+100	Amount of modulation source

Stereo Tremolo

This effect modulates the volume level of the input signal. The effect is stereo, and offsetting the LFO of the left and right phases from each other produces a tremolo effect between left and right.

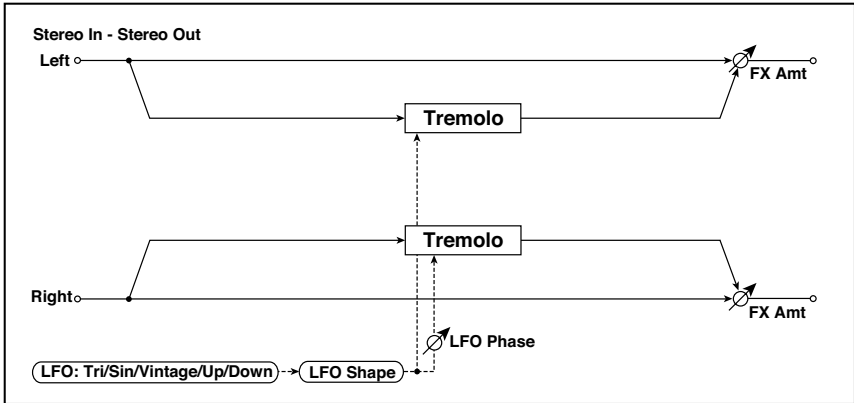

a	LFO Waveform	Triangle, Sine, Vintage, Up, Down	Selects the LFO Waveform
	LFO Shape	-100...+100	Changes the curvature of the LFO Waveform
b	LFO Phase [degree]	-180...+180	Sets the LFO phase difference between the left and right
c	LFO Frequency [Hz]	0.02...20.00	Sets the speed of the LFO
	Src	Off...Tempo	Selects a modulation source for LFO speed
	Amt	-20.00...+20.00	Sets the modulation amount of LFO speed
d	MIDI Sync	Off, On	When this is on, the LFO speed is set by BPM, Base Note, and Times, instead of Frequency
	BPM	MIDI, 40.00...300.00	MIDI syncs to the system tempo; 40-300 sets the tempo manually for this individual effect
	Base Note		Selects the type of notes that specify the LFO speed
	Times	x1...x32	Sets the number of notes that specify the LFO speed
e	Depth	0...100	Sets the depth of LFO modulation
	Src	Off...Tempo	Selects the modulation source of the depth of modulation
	Amt	-100...+100	Sets the modulation amount of the depth of modulation

f	Wet/Dry	Dry, 1:99...99:1, Wet	Balance between the wet and dry signal
	Src	Off...Tempo	See the list of DMS (Dynamic Modulation Sources) at the beginning of this part
	Amt	-100...+100	Amount of modulation source

■ a: LFO Waveform

This parameter sets the basic shape of the LFO. The **Vintage** waveform models classic guitar-amp tremolo.

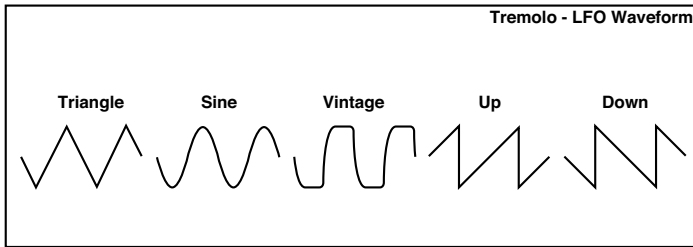

■ b: LFO Phase [degree]

This parameter determines the difference between the left and right LFO phases. A higher value will simulate the auto-pan effect in which the sound is panned between left and right.

Stereo Envelope Tremolo

This effect uses the input signal level to modulate a stereo tremolo (LFO volume modulation). For instance, you can create a tremolo effect that becomes deeper and faster as the input gets more quiet.

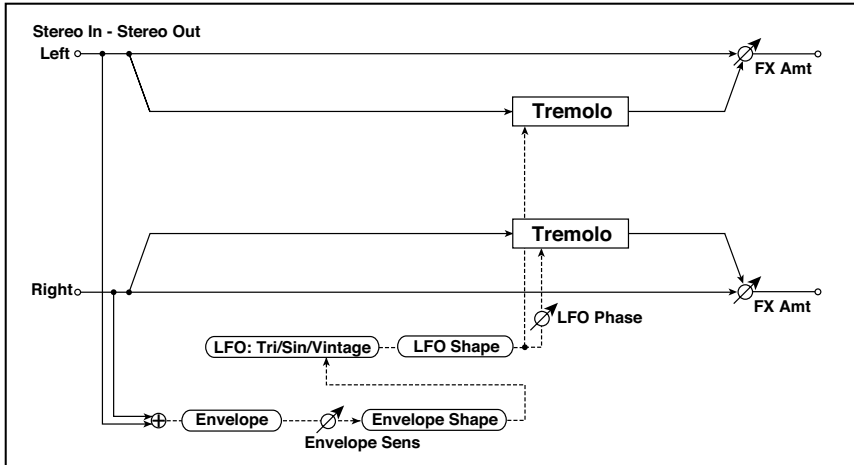

a	Envelope Sens	0...100	Sets the envelope's sensitivity to the input signal
	Envelope Shape	-100...+100	Sets the envelope's curvature
b	LFO Waveform	Triangle, Sine, Vintage	Selects the LFO Waveform
	LFO Shape	-100...+100	Changes the curvature of the LFO Waveform
c	LFO Phase [degree]	-180...+180	Sets the LFO phase difference between the left and right
d	LFO Frequency [Hz]	0.02...20.00	Sets the speed of the LFO
	Envelope Amount [Hz]	-20.00...+20.00	Sets the amount added to or subtracted from the Frequency when the envelope is at maximum
e	Depth	0...100	Sets the initial amount of tremolo
	Envelope Amount	-100...+100	Sets the amount added to or subtracted from the Depth when the envelope is at maximum
f	Wet/Dry	Dry, 1:99...99:1, Wet	Balance between the wet and dry signal
	Src	Off...Tempo	See the list of DMS (Dynamic Modulation Sources) at the beginning of this part
	Amt	-100...+100	Amount of modulation source

- **d: LFO Frequency [Hz]**
- **d: Envelope Amount [Hz]**
- **e: Depth**
- **e: Envelope Amount**

The graphic below shows an example of tremolo modulation with negative modulation of both **Depth** and **Frequency**. At the start of the note, the input is at maximum volume. This slows down the LFO **Frequency** to 1.0Hz, but also modulates the **Depth** to 0—so the tremolo doesn't have any effect.

As the input volume dies down, the **Frequency** speeds up; the **Depth** also increases, making the tremolo effect increasingly audible. When the input volume approaches silence, the **Depth** is at its maximum (100) and **Frequency** is at 8Hz.

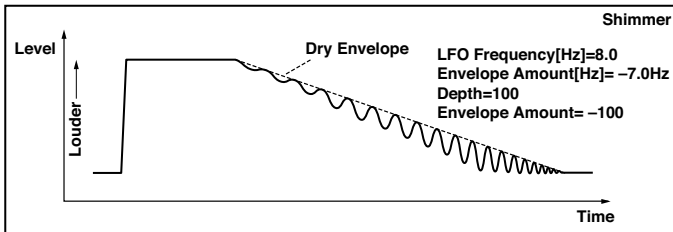

Stereo Auto Pan

This is a stereo-in, stereo-out auto-panner. The Phase and Shape parameters lets you create various panning effects, such as making the left and right inputs seem to chase each other around the stereo field.

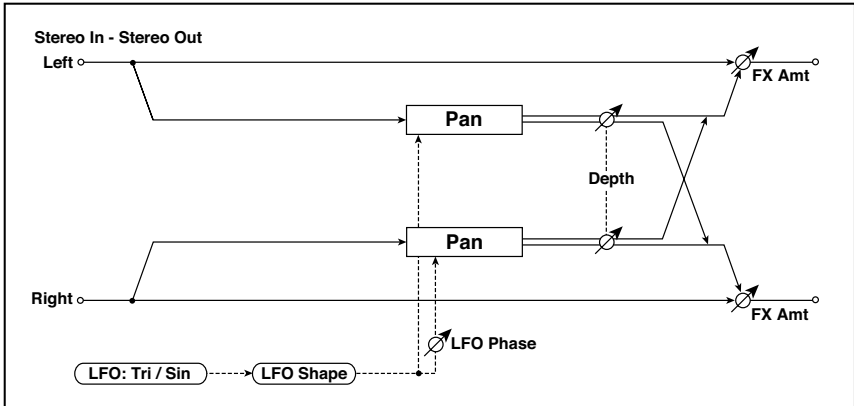

a	LFO Waveform	Triangle, Sine	Selects the LFO Waveform
	LFO Shape	-100...+100	Changes the curvature of the LFO Waveform
b	LFO Phase [degree]	-180...+180	Sets the LFO phase difference between the left and right
c	LFO Frequency [Hz]	0.02...20.00	Sets the speed of the LFO
	Src	Off...Tempo	Selects a modulation source for LFO speed
	Amt	-20.00...+20.00	Sets the modulation amount of LFO speed
d	MIDI Sync	Off, On	When this is on, the LFO speed is set by BPM, Base Note, and Times, instead of Frequency
	BPM	MIDI, 40.00...300.00	MIDI syncs to the system tempo; 40–300 sets the tempo manually for this individual effect
	Base Note		Selects the type of notes that specify the LFO speed
	Times	x1...x32	Sets the number of notes that specify the LFO speed
e	Depth	0...100	Sets the depth of LFO modulation
	Src	Off...Tempo	Selects the modulation source of the depth of modulation
	Amt	-100...+100	Sets the modulation amount of the depth of modulation
f	Wet/Dry	Dry, 1:99...99:1, Wet	Balance between the wet and dry signal
	Src	Off...Tempo	See the list of DMS (Dynamic Modulation Sources) at the beginning of this part
	Amt	-100...+100	Amount of modulation source

■ a: LFO Shape

You can change the panning curve by modifying the LFO's Shape.

■ b: LFO Phase [degree]

This determines the phase difference between the left and right LFOs. When you gradually change the value away from 0, the sounds from the left and right channels will seem to chase each other around. If you set the parameter to +180 or -180, the sounds from each channel will cross over each other.

You'll only hear the effect of this parameter if the input is true stereo, with different signals in the left and right channels.

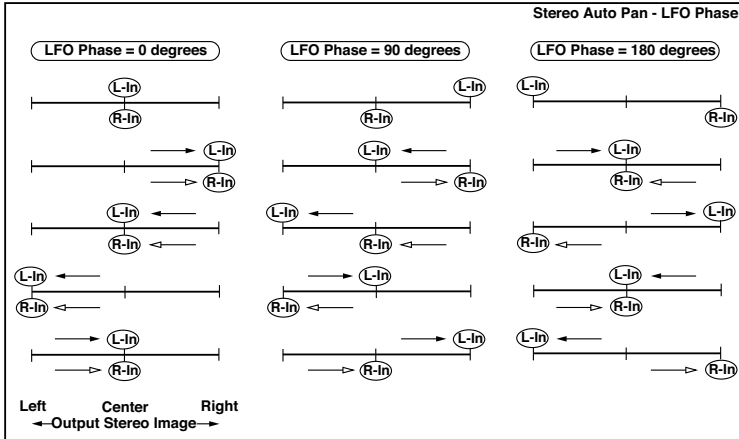

Stereo Phaser + Tremolo

This effect combines a stereo phaser and tremolo, with linked LFOs. Swelling phaser modulation and tremolo effects synchronize with each other, creating a soothing modulation effect particularly suitable for electric piano.

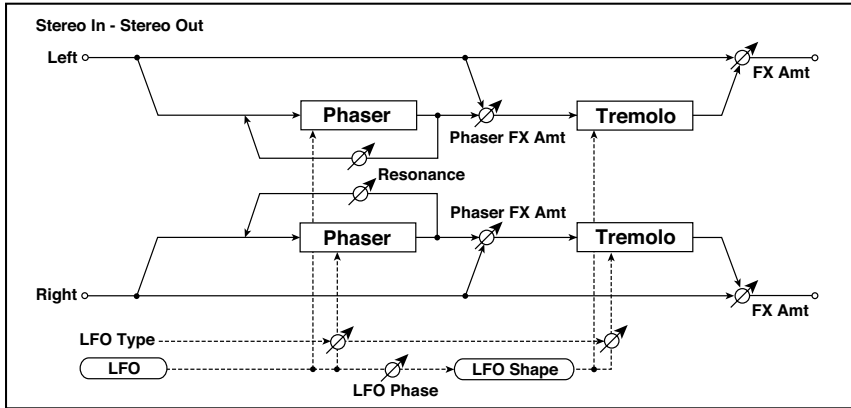

a	Type	Phs - Trml, ... Phs LR - Trml LR	Selects the type of the tremolo and phaser LFOs Phaser - Tremolo, Phaser - Tremolo Spin, Phaser - Tremolo LR, Phaser LR - Tremolo, Phaser LR - Tremolo Spin, Phaser LR - Tremolo LR
	LFO Phase [degree]	-180...+180	Sets the phase difference between the tremolo and phaser LFOs
b	LFO Frequency [Hz]	0.02...20.00	Sets the speed of the LFO
	Src	Off...Tempo	Selects a modulation source for LFO speed
	Amt	-20.00... +20.00	Sets the LFO speed modulation amount
c	MIDI Sync	Off, On	When this is on, the LFO speed is set by BPM, Base Note, and Times, instead of Frequency
	BPM	MIDI, 40.00... 300.00	MIDI syncs to the system tempo; 40-300 sets the tempo manually for this individual effect
	Base Note		Selects the type of notes that specify the LFO speed
	Times	x1...x32	Sets the number of notes that specify the LFO speed

d	Phaser Manual	0...100	Sets the phaser frequency range
	Resonance	-100...+100	Sets the phaser resonance amount
e	Phaser Depth	0...100	Sets the phaser modulation depth
	Src	Off...Tempo	Selects the modulation source for the phaser modulation depth
	Amt	-100...+100	Sets the modulation amount for the phaser modulation depth
f	Phaser Wet/Dry	-Wet, -2 : 98... Dry... 2 : 98, Wet	Sets the balance between the phaser effect and dry sounds
g	Tremolo Shape	-100...+100	Sets the degree of the tremolo LFO shaping
h	Tremolo Depth	0...100	Sets the tremolo modulation depth
	Src	Off...Tempo	Selects the modulation source for the tremolo modulation depth
	Amt	-100...+100	Sets the modulation amount of the tremolo modulation depth
i	Wet/Dry	Dry, 1:99...99:1, Wet	Balance between the wet and dry signal
	Src	Off...Tempo	See the list of DMS (Dynamic Modulation Sources) at the beginning of this part
	Amt	-100...+100	Amount of modulation source

- **a: Type**

- **a: LFO Phase [degree]**

Select the type of phaser LFO and tremolo LFO for the “Type” parameter. How the effect sound moves or rotates depends on the type of LFO. Selecting “LFO Phase” enables you to offset the timing of the phaser peak and control a subtle movement and rotation of the sound.

- **f: Phaser Wet/Dry**

- **i: Wet/Dry**

PHASER Wet/Dry sets the balance between the phaser output and the dry sound. **OUTPUT Wet/Dry** sets the balance between the final phaser and tremolo output level and the dry sound.

Stereo Ring Modulator

This effect creates a metallic sound by applying the oscillators to the input signal. Use the LFO or Dynamic Modulation to modulate the oscillator to create a radical modulation. Matching the oscillator frequency with a note number will produce a ring modulation effect in specific key ranges.

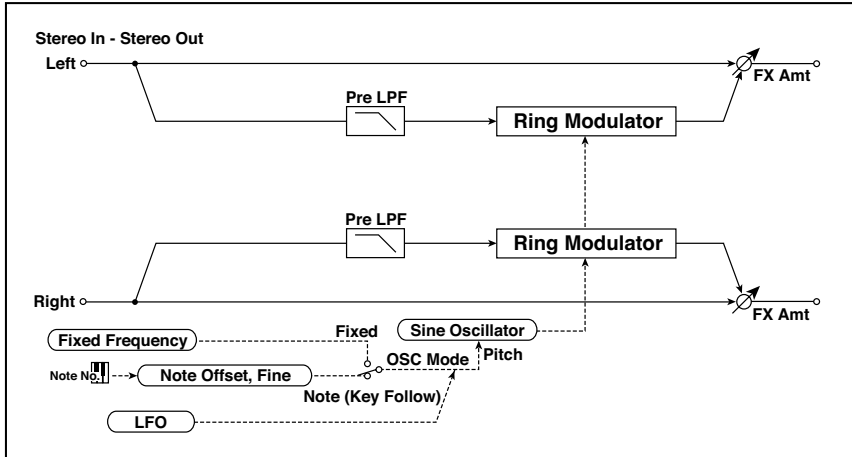

a	OSC Mode	Fixed, Note (Key Follow)	Switching between specifying the oscillator frequency and using a note number
	Pre LPF	0...100	Sets the damping amount of the high range input to the ring modulator
b	Fixed Frequency [Hz]	0...12.00k	Sets the oscillator frequency when OSC Mode is set to Fixed
	Src	Off...Tempo	Selects the modulation source for the oscillator frequency when OSC Mode is set to Fixed
	Amt	-12.00k...+12.00k	Sets the modulation amount of the oscillator frequency when OSC Mode is set to Fixed
c	Note Offset	-48...+48	Sets the pitch difference from the original note when OSC Mode is set to Note (Key Follow)
	Note Fine	-100...+100	Fine-adjusts the oscillator frequency
d	LFO Frequency [Hz]	0.02...20.00	Sets the speed of the LFO
	Src	Off...Tempo	Selects a modulation source for LFO speed
	Amt	-20.00...+20.00	Sets the modulation amount of LFO speed
e	MIDI Sync	Off, On	When this is on, the LFO speed is set by BPM, Base Note, and Times, instead of Frequency
	BPM	MIDI, 40.00...300.00	MIDI syncs to the system tempo; 40-300 sets the tempo manually for this individual effect
	Base Note	 ...	Selects the type of notes that specify the LFO speed
	Times	x1...x32	Selects the number of notes that specify the LFO speed
f	LFO Depth	0...100	Sets the depth of LFO modulation for the oscillator frequency
	Src	Off...Tempo	Selects the modulation source of the depth of modulation
	Amt	-100...+100	Sets the modulation amount of the depth of modulation
g	Wet/Dry	Dry, 1:99...99:1, Wet	Balance between the wet and dry signal
	Src	Off...Tempo	See the list of DMS (Dynamic Modulation Sources) at the beginning of this part
	Amt	-100...+100	Amount of modulation source

■ a: OSC Mode

This parameter determines whether or not the oscillator frequency follows the note number.

■ a: Pre LPF

This parameter enables you to set the damping amount of the high range sound input to the ring modulator. If the input sound contains lots of harmonics, the effect may sound dirty. In this case, cut a certain amount of high range.

■ b: Fixed Frequency [Hz]

This parameter sets the oscillator frequency when “OSC Mode” is set to Fixed.

■ c: Note Offset

■ c: Note Fine

These parameters for the oscillator are used when “OSC Mode” is set to Note (Key Follow). The “Note Offset” sets the pitch difference from the original note in semitone steps. The “Note Fine” parameter fine-adjusts the pitch in cent steps. Matching the oscillator frequency with the note number produces a ring modulation effect in the correct key.

Organ Vibrato / Chorus

This effect simulates the chorus and vibrato circuitry of a vintage organ. The modulation speed and depth can be customized.

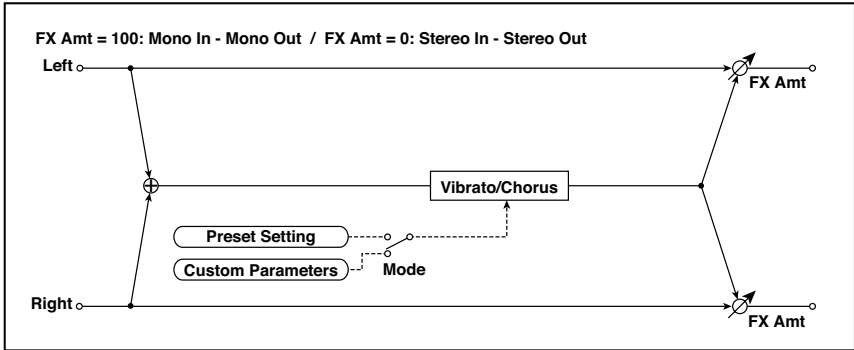

a	Input Trim	0...100	Sets the input level
b	Control Mode	Preset, Custom	Selects either preset or custom settings
c	Preset Type	V1, C1, V2, C2, V3, C3	Selects the effect type when Mode=Preset V1/V2/V3 are variations of vibrato, and C1/C2/C3 are variations of chorus
	Src	Off...Tempo	Selects the modulation source that will change the effect type
	Amt	-5...+5	Sets the modulation amount for changing the effect type
d	Custom Mix	Vibrato, 1:99...99:1, Chorus	Sets the mix level of the direct sound when Mode=Preset
	Src	Off...Tempo	Selects the modulation source that will control the mix level of the direct sound
	Amt	-100...+100	Sets the modulation amount for controlling the mix level of the direct sound
e	Custom Depth	0...100	Sets the vibrato depth
	Src	Off...Tempo	Selects the modulation source that will control vibrato depth
	Amt	-100...+100	Sets the modulation amount for controlling the vibrato depth

f	Custom Speed [Hz]	0.02...20.00	Sets the vibrato speed
	Src	Off...Tempo	Selects the modulation source for controlling the vibrato speed
	Amt	-20.00...+20.00	Sets the modulation amount for controlling the vibrato speed
g	Wet/Dry	Dry, 1:99...99:1, Wet	Balance between the wet and dry signal
	Src	Off...Tempo	See the list of DMS (Dynamic Modulation Sources) at the beginning of this part
	Amt	-100...+100	Amount of modulation source

- **b: Control Mode**

- **c: Preset Type**

- **d: Custom Mix**

- **e: Custom Depth**

- **f: Custom Speed [Hz]**

If Control Mode=Preset, you can use c: Preset Type to select the effect. In this case, the Custom Mix/Depth/Speed settings are ignored. If Control Mode=Custom, the Custom Mix/Depth/Speed settings are valid, and the c: Preset Type setting is ignored.

- **c: Amt**

If Preset Type=V1 and Src=JS+Y, you can set this to +5 and move JS +Y to control the effect in the order of V1>C1>V2>C2>V3>C3.

Rotary Speaker

This effect simulates a rotary speaker, and obtains a more realistic sound by simulating the rotor in the low range and the horn in the high range separately. The effect also simulates the stereo microphone settings.

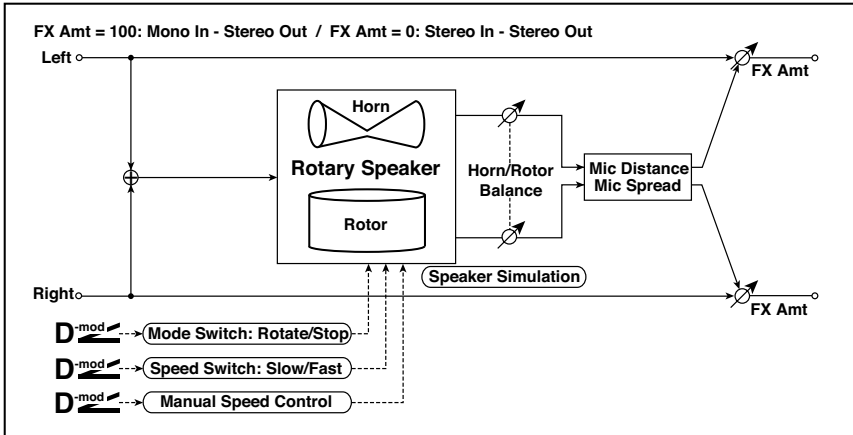

a	Mode Switch	Rotate, Stop	Switches between speaker rotation and stop
	Src	Off...Tempo	Selects a modulation source for Rotate/Stop
	Mode	Toggle, Moment	Sets the switch mode for Rotate/Stop modulation
b	Speed Switch	Slow, Fast	Switches the speaker rotation speed between slow and fast
	Src	Off...Tempo	Selects a modulation source for Slow/Fast
	Mode	Toggle, Moment	Sets the switch mode for Slow/Fast modulation
c	Manual Speed Ctrl	Off...Tempo	Sets a modulation source for direct control of rotation speed
d	Horn Acceleration	0...100	How quickly the horn rotation speed in the high range is switched
	Horn Ratio	Stop, 0.50...2.00	Adjusts the (high-range side) horn rotation speed. Standard value is 1.00. Selecting "Stop" will stop the rotation
e	Rotor Acceleration	0...100	Determines how quickly the rotor rotation speed in the low range is switched
	Rotor Ratio	Stop, 0.50...2.00	Adjusts the (low-frequency) rotor speed. Standard value is 1.00. Selecting "Stop" will stop the rotation

f	Horn/Rotor Balance	Rotor, 1...99, Horn	Sets the level balance between the high-frequency horn and low-frequency rotor
g	Mic Distance	0...100	Sets the distance between the microphone and rotary speaker
	Mic Spread	0...100	Sets the angle of left and right microphones
h	Wet/Dry	Dry, 1:99...99:1, Wet	Balance between the wet and dry signal
	Src	Off...Tempo	See the list of DMS (Dynamic Modulation Sources) at the beginning of this part
	Amt	-100...+100	Amount of modulation source

■ a: Mode

This parameter sets how the modulation source switches between rotation and stop.

When **Mode = Toggle**, the speaker rotates or stops alternately each time you press the pedal or move the joystick. Via MIDI, rotation will switch between start and stop each time the modulation amount exceeds 64.

When **Mode = Moment**, the speaker rotates by default, and stops only when you press the pedal or move the joystick. Via MIDI, modulation values above 64 make the speaker rotate, and values below 64 make it stop.

■ b: Speed Switch

This parameter controls how the rotation speed (slow and fast) is switched via the modulation source.

When **Mode = Toggle**, the speed will switch between slow and fast each time you press the pedal or move the joystick. Via MIDI, the speed will switch each time the modulation amount exceeds 64.

When **Mode = Moment**, the speed is usually slow. It becomes fast only when you press the pedal or move the joystick. Via MIDI, modulation values above 64 set the speed to **Fast**, and values below 64 set it to **Slow**.

■ c: Manual Speed Ctrl

If you wish to control the rotation speed manually, instead of switching between Slow and Fast, select a modulation source in the **Manual Speed Ctrl** parameter. If you don't want to use manual control, set this to **Off**.

-
- **d: Horn Acceleration**
 - **e: Rotor Acceleration**
-

On a real rotary speaker, the rotation speed accelerates or decelerates gradually after you switch the speed. The **Horn** and **Rotor Acceleration** parameters set the transition times between fast and slow speeds.

-
- **g: Mic Distance**
 - **g: Mic Spread**
-

This is a simulation of stereo microphone settings.

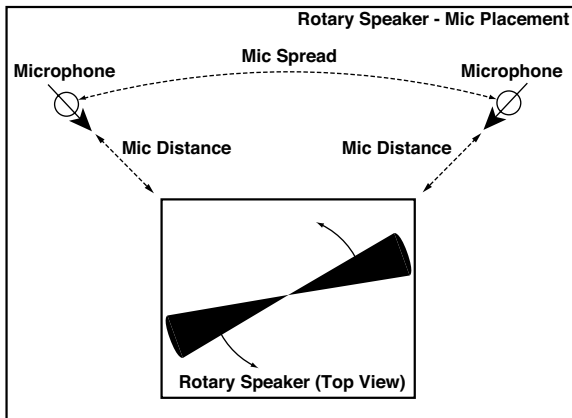

Phaser + Chorus/Flanger

This effect combines a mono phaser and a chorus/flanger.

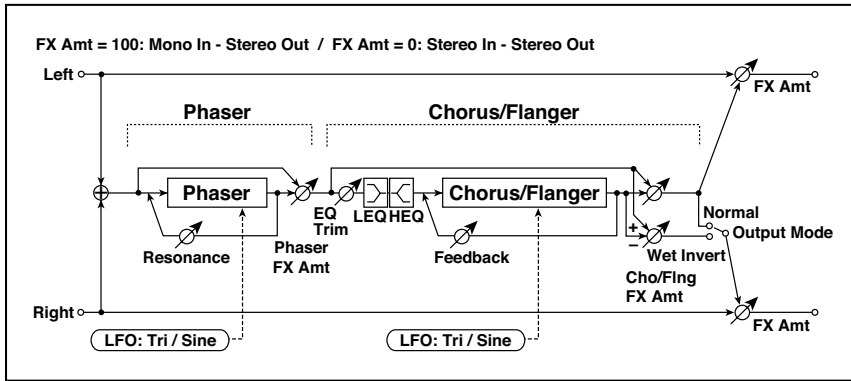

PHASER

a	[P]LFO Frequency [Hz]	0.02...20.00	Sets the speed of the LFO
	LFO Waveform	Triangle, Sine	Selects the LFO Waveform
b	[P]Manual	0...100	Sets the frequency to which the effect is applied
	Depth	0...100	Sets the depth of LFO modulation
	Resonance	-100...+100	Sets the resonance amount
c	[P]Phaser Wet/Dry	-Wet, -1:99... Dry...99:1, Wet	Sets the phaser effect balance

CHORUS/FLANGER

d	[F]LFO Frequency [Hz]	0.02...20.00	Sets the speed of the LFO
	LFO Waveform	Triangle, Sine	Selects the LFO Waveform
e	[F]Delay Time [msec]	0.0...1350.0	Sets the delay time
	Depth	0...100	Sets the depth of LFO modulation
	Feedback	-100...+100	Sets the feedback amount
f	[F]EQ Trim	0...100	Sets the EQ input level
g	[F]PreLEQ Gain [dB]	-15...+15	Sets the gain of Low EQ
	PreHEQ Gain [dB]	-15...+15	Sets the gain of High EQ

h	[F]Cho/FIng Wet/Dry	-Wet, -1:99... Dry...99:1, Wet	Sets the effect balance of the chorus/flanger
	Src	Off...Tempo	Selects the Wet/Dry modulation source for the chorus/flanger
	Amt	-100...+100	Sets the Wet/Dry modulation amount for the chorus/flanger
i	[F]Output Mode	Normal, Wet Invert	Selects the output mode for the chorus/flanger
j	Wet/Dry	Dry, 1:99...99:1, Wet	Balance between the wet and dry signal
	Src	Off...Tempo	See the list of DMS (Dynamic Modulation Sources) at the beginning of this part
	Amt	-100...+100	Amount of modulation source

Rotary Speaker OD

This is a stereo rotary speaker effect. It has an internal speaker simulator that simulates overdrive (recreating the amp distortion) and characteristics of the rotary speaker, producing a very realistic rotary speaker sound.

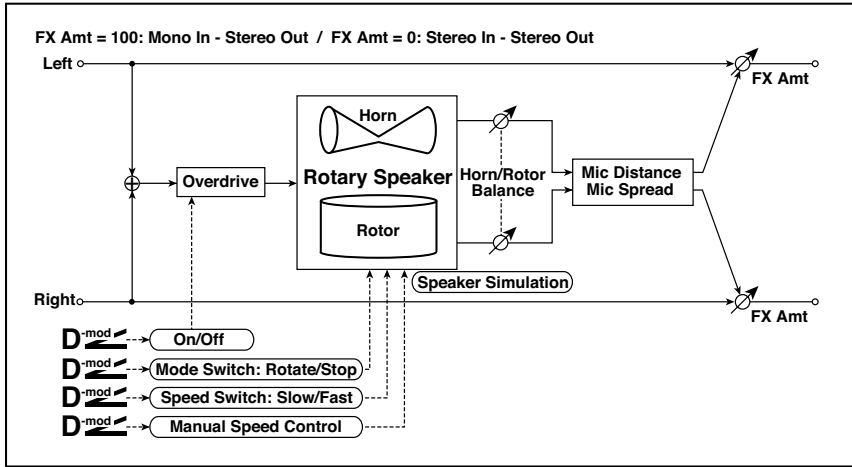

a	Overdrive	Off, On	Switches overdrive on/off
	Src	Off...Tempo	Selects a modulation source to switch overdrive on/off
	Sw	Toggle, Moment	Sets the switch mode for overdrive on/off modulation
b	Overdrive Gain	0...100	Determines the degree of distortion
	Overdrive Level	0...100	Sets the overdrive output level
c	Overdrive Tone	0...15	Sets the tonal quality of the overdrive
	Speaker Simulator	Off, On	Switches the speaker simulation on/off
d	Mode Switch	Rotate, Stop	Switches between speaker rotation and stop
	Src	Off...Tempo	Selects a modulation source for Rotate/Stop
	Sw	Toggle, Moment	Sets the switch mode for Rotate/Stop modulation
e	Speed Switch	Slow, Fast	Switches the speaker rotation speed between slow and fast
	Src	Off...Tempo	Selects a modulation source for Slow/Fast
	Sw	Toggle, Moment	Sets the switch mode for Slow/Fast modulation

f	Horn/Rotor Balance	Rotor, 1...99, Horn	Sets the volume balance between the high-range horn and low-range rotor
	Manual SpeedCtrl	Off...Tempo	Sets a modulation source for direct control of rotation speed
g	Horn Acceleration	0...100	Sets how quickly the horn rotation speed changes
	Horn Ratio	Stop, 0.50...2.00	Adjusts the (high-frequency) horn rotation speed. Standard value is 1.00. "Stop" stops the rotation
h	Rotor Acceleration	0...100	Sets how quickly the rotor speed changes
	Rotor Ratio	Stop, 0.50...2.00	Adjusts the (low-frequency) rotor rotation speed. Standard value is 1.0. "Stop" stops the rotation
i	Mic Distance	0...100	Distance between the microphone and rotary speaker
	Mic Spread	0...100	Angle of left and right microphones
j	Wet/Dry	Dry, 1:99...99:1, Wet	Balance between the wet and dry signal
	Src	Off...Tempo	See the list of DMS (Dynamic Modulation Sources) at the beginning of this part
	Amt	-100...+100	Amount of modulation source

■ a: Sw

This parameter determines how to switch on/off the overdrive via a modulation source.

When "Sw" = Toggle, overdrive is turned on/off each time the pedal or joystick is operated.

MIDI Overdrive will be switched on/off each time the value of the modulation source exceeds 64.

When "Sw" = Moment, overdrive is applied only when you press the pedal or operate the joystick.

MIDI Only when the value for the modulation source is 64 or higher, the overdrive effect is applied.

U-Vibe

Modeled on the most famous chorus/vibrato pedal effect unit. This effect simulates a rotating speaker and produces a wonderfully seductive and 'watery' tone. Interestingly enough, the guy responsible for this great pedal is also responsible for the birth of the KORG Nuvibe and Valve Reactor Technology.

a	Speed [Hz]	1...100	Sets the speed of the U-Vibe effect
	Src	Off...Tempo	Selects a modulation source for the U-Vibe effect
	Amt	-10.00... +10.00	Sets the modulation amount of the U-Vibe effect
b	Depth	0...100	Sets the depth of the U-Vibe effect
	Src	Off...Tempo	Selects the modulation source of the LFO modulation depth
	Amt	-100...+100	Sets the modulation amount of the LFO modulation depth
c	Mix	0...100	Sets the effect mix level
	Src	Off...Tempo	Selects the modulation source of the effect mix level
	Amt	-100...+100	Sets the modulation amount of the effect mix level
d	Wet/Dry	Dry, 1:99...99:1, Wet	Balance between the wet and dry signal
	Src	Off...Tempo	See the list of DMS (Dynamic Modulation Sources) at the beginning of this part
	Amt	-100...+100	Amount of modulation source

Orange Phaser

This phaser pedal is a favorite on many recordings. It's useful for adding sparkle, animating chord passages, and widening and fattening the sound.

The original had only a speed control; this version adds depth, control of the center frequency, and more.

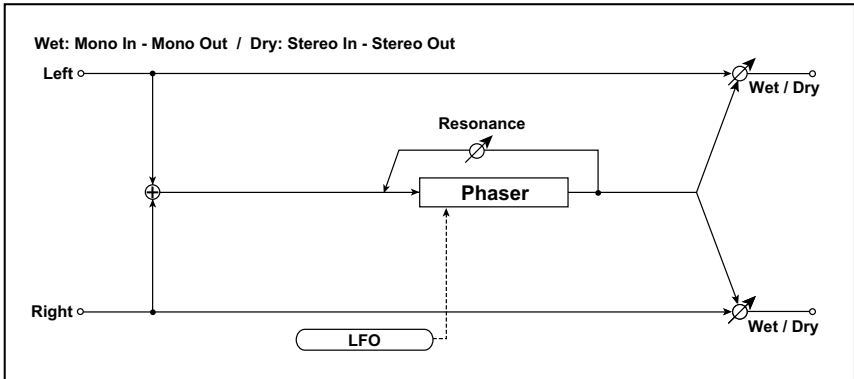

a	Speed	0.10...10.00	This controls the speed of the phaser's LFO.
	Src	Off...Tempo	Selects a modulation source for LFO speed
	Amt	-20.00... +20.00	Sets the modulation amount of LFO speed
b	Depth	0...100	Sets the depth of LFO modulation
	Src	Off...Tempo	Selects the modulation source for the LFO modulation depth
	Amt	-100...+100	Sets the modulation amount of the LFO modulation depth
c	Resonance	-100...+100	This controls the intensity of the phaser effect. The default is 26. Mixing the processed and dry signals via Wet/Dry will enhance the effect.
d	Manual	0...100	Sets the frequency to which the effect is applied
e	Wet/Dry	-Wet, -1:99... Dry...99:1, Wet	Balance between the wet and dry signal
	Src	Off...Tempo	See the list of DMS (Dynamic Modulation Sources) at the beginning of this part
	Amt	-100...+100	Amount of modulation source

Small Phaser

This classic phaser, made in New York City during the 70s, has a notably warm and rich tone with liquid transparency.

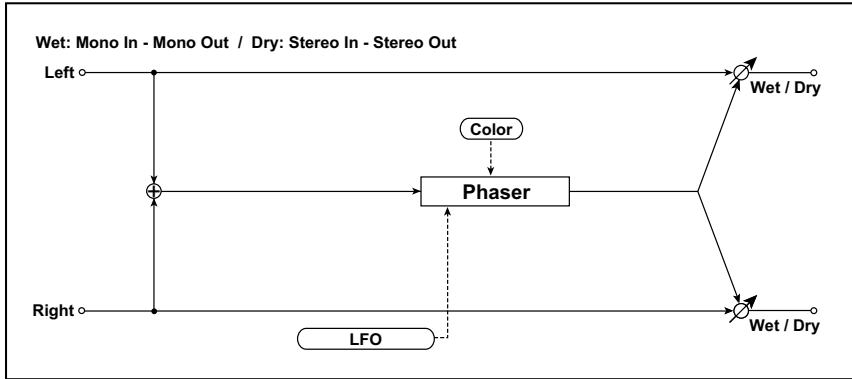

a	Speed	0.10...10.00	This controls the speed of the phaser's LFO. The default is 1.00 Hz.
	Src	Off...Tempo	Selects a modulation source for LFO speed
	Amt	-20.00... +20.00	Sets the modulation amount of LFO speed
c	Color	Off, On	This changes the sound of the phaser between a full and round phase shift when set to Off, and a more pronounced effect when set to On.
e	Wet/Dry	-Wet, -1:99... Dry...99:1, Wet	Balance between the wet and dry signal
	Src	Off...Tempo	See the list of DMS (Dynamic Modulation Sources) at the beginning of this part
	Amt	-100...+100	Amount of modulation source

Classic Chorus

This models a famous chorus unit that was built into a guitar amp. Although it does not provide a chorus and vibrato select switch, you can use the “Wet/Dry” and “Bus” settings to produce their effect. The “Speed,” “Depth,” and “Manual” parameters allow an even wider range of sounds than the original unit.

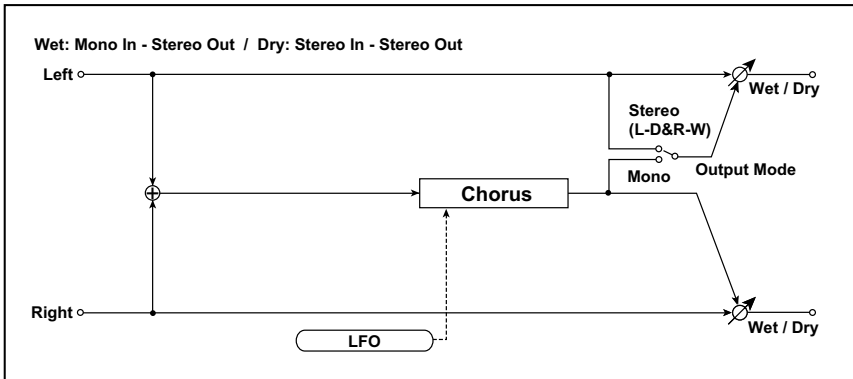

a	Speed [Hz]	0.10...10.0	Sets the LFO speed
	Src	Off...Tempo	Modulation for the chorus speed. See the list of DMS (Dynamic Modulation Sources) at the beginning of this part
	Amt	-10.00... +10.00	Sets the modulation amount of the chorus speed
b	Depth	1...100	Sets the depth of LFO modulation
	Src	Off...Tempo	Modulation for the chorus depth. See the list of DMS (Dynamic Modulation Sources) at the beginning of this part
	Amt	-100 ... +100	Sets the modulation amount of the chorus depth
c	Manual	0...99	Sets the delay time for chorus. If Depth is set to 100, Manual will not function.
d	Output Mode	Mono, Stereo (L-Dry&R-Wet)	The output mode switches between vibrato and chorus. Mono is a vibrato, Stereo is a chorus.
e	Wet/Dry	Dry, 1:99 ... 99:1, Wet	Balance between the wet and dry signal
	Src	Off...Tempo	Selects a modulation source for Wet/Dry
	Amount	-100 ... +100	Sets the modulation amount for Wet/Dry

Classic Flanger

This models a classic analog flanger. It is highly effective for chording on clavichord keyboards or electric piano.

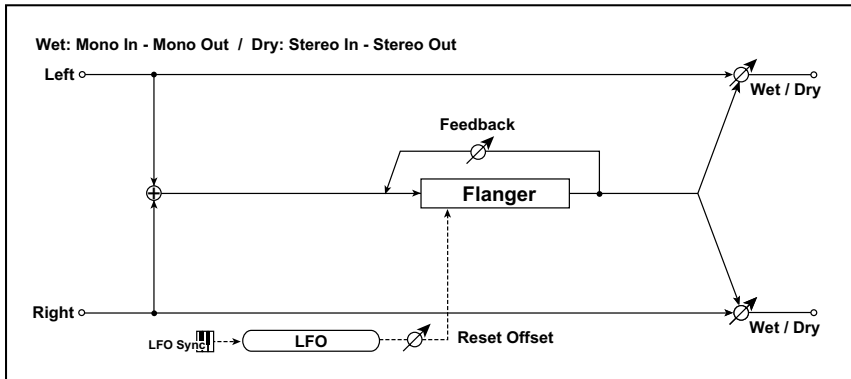

a	Speed [Hz]	0.10...10.0	Sets the speed of LFO
	Src	Off...Tempo	Selects a modulation source for LFO speed
	Amt	-10.00... +10.00	Sets the modulation amount of flanger speed
b	Depth	0...100	Sets the depth of flanger modulation
	Src	Off...Tempo	Selects the modulation source of the flanger modulation depth
	Amt	-100...+100	Sets the modulation amount of the LFO modulation depth
c	Resonance	0...100	Sets the resonance amount
d	Manual	0...100	Sets the sweep frequency. If Depth is set to 100, Manual will not function.
e	LFO Reset Src	Off...Tempo	Selects a modulation source for LFO reset
	Reset Offset	0...100	Sets the offset
f	Wet/Dry	-Wet, -1:99... Dry...99:1, Wet	Balance between the wet and dry signal
	Src	Off...Tempo	See the list of DMS (Dynamic Modulation Sources) at the beginning of this part
	Amt	-100...+100	Amount of modulation source

Classic Tremolo

Vintage Tremolo effect.

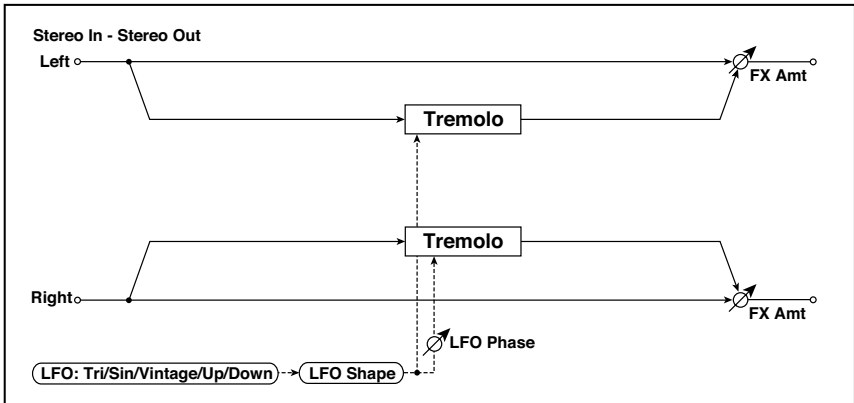

a	Speed	0.10...10.00	Sets the speed of the LFO
	Src	Off...Tempo	Modulation for the tremolo speed. See the list of DMS (Dynamic Modulation Sources) at the beginning of this part
	Amt	-10.00... +10.00	Sets the modulation amount of the tremolo speed
b	Depth	0...100	Sets the initial amount of tremolo
	Src	Off...Tempo	Modulation for the tremolo depth. See the list of DMS (Dynamic Modulation Sources) at the beginning of this part
	Amt	-10.00... +10.00	Sets the modulation amount of the tremolo depth
c	Spread	0...100	Sets the width of the stereo image of the effect sound
d	Level Adjust	0...99	Level of the effect
e	Wet/Dry	Dry, 1:99...99:1, Wet	Balance between the wet and dry signal
	Src	Off...Tempo	See the list of DMS (Dynamic Modulation Sources) at the beginning of this part
	Amt	-100...+100	Amount of modulation source

Black Chorus / Flanger

This models a Danish-made stereo chorus + pitch modulator & flanger. Although this effect was originally intended for guitar, it was also used by numerous key-board players. Used with electric piano, it produces a distinctive tone.

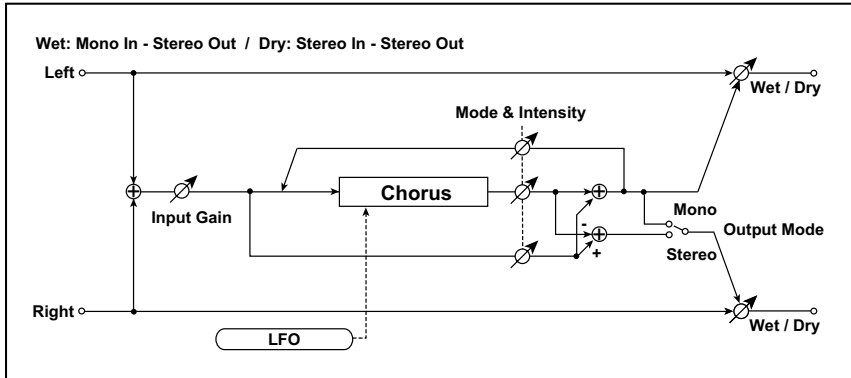

a	Speed [Hz]	0.10...10.0	Sets the LFO speed
	Src	Off...Tempo	Modulation for the LFO speed. See the list of DMS (Dynamic Modulation Sources) at the beginning of this part
	Amt	-10.00... +10.00	Sets the modulation amount of the LFO speed
	Intensity	1...100	Sets the intensity of LFO modulation
b	Mode	0, 1, 2	Select a mode 0: Chorus 1: Pitch Modulation 2: Flanger
c	Width	0...2	Sets the LFO modulation depth
d	Input Gain	1...100	Sets the input gain
e	Output Mode	0, 1	Select a output mode 0: Mono 1: Stereo
f	Wet/Dry	Dry, 1:99 ... 99:1, Wet	Balance between the wet and dry signal
	Source	Off...Tempo	Selects a modulation source for Wet/Dry
	Amount	-100 ... +100	Sets the modulation amount for Wet/Dry

-
- **a: Intensity**
 - **b: Mode**
-

Increasing the “Intensity” value will strengthen the modulation effect. This controls the effect, direct, and feedback values. The values that are controlled will depend on the “Mode” setting.

CS-3 Rotary Speaker

This models a stereo rotary speaker. When you choose the Slow or Fast speed, it will take a certain amount of time for the specified speed to be reached – just like on an actual rotary speaker. This is because it takes several seconds for the motor that creates the rotation to accelerate or decelerate.

The rotary speaker is made of two parts: the horn and the rotor.

The horn carries the high frequencies of the rotary speaker. You can independently control the Slow and Fast speeds of the horn, as well as the time it takes to speed up or slow down. You also have separate control over the amount of time that the horn takes to stop rotating entirely, and the time that it takes to resume rotation after being stopped.

The rotor carries the low frequencies of the rotary speaker.

The selected speaker type can have a significant effect on the overall tone – something particularly noticeable at fast rotary speeds. Natural is based on new analysis of a classic vintage rotary speaker. Resonant has more mid-frequency bite than Natural, similar to a popular rotary speaker effects pedal. Bright is based on Natural, but with less high-end roll-off for a brighter sound. Original is the same as the original KORG CX-3 speaker simulator.

HINT: Some speaker types have sharp resonances in their frequency responses, which may cause higher volumes with specific sounds and notes. If the volume is already high, this can cause clipping at the outputs. If this happens, simply turn down the amp level and/or the program volume.

Rotary Speaker

a	Switch	On, Off	This enables and disables the Rotary Speaker. It's different from simply stopping the rotation (which you can do with the Mode SW parameter); instead, this is like unplugging the organ from the rotary speaker entirely. When the Rotary Speaker is turned off, the tone is determined by the Speaker Off Out parameter.
	Src	Off...Tempo	Selects a modulation source for Switch
b	Switch Mode	Toggle, Moment	Sets the switch mode for Switch

c	Speaker Off Out	Pre-, Post-Xover	<p>This determines the sound when the Rotary Speaker is turned off. It also determines the dry signal in the Wet/Dry mix.</p> <p>Post-Xover is the default, and matches the CX-3. With this setting, the speaker simulator and speaker crossover will still be active, even when the Rotary Speaker is disabled. Use this if you like the CX-3 sound, and are not sending the organ through a separate Rotary Speaker in the Insert Effects.</p> <p>Pre-Xover yields a tone without the effects of the speaker simulator and crossovers. Use this setting if you'll be sending the organ through a separate Rotary Speaker in the Insert Effects.</p>
d	Wet/Dry	Dry, 1:99 ... 99:1, Wet	Balance between the wet and dry signal. The dry signal is either the pre-crossover or post-crossover input, as selected by the Speaker Off Out parameter.
	Src	Off...Tempo	Selects a modulation source for Wet/Dry
e	Wet/Dry Mod.Int	-100 ... +100	Sets the modulation amount for Wet/Dry
Mode/Speed			
f	Mode SW	Rotate, Stop	Mode Switch lets you stop the motion of the Rotary Speaker. Even when stopped, the speaker will still affect the timbre. The horn and rotor can each take different amounts of time to start and stop their rotation (see below).
	Src	Off...Tempo	Selects a modulation source for Mode SW
g	Mode SW Mode	Toggle, Moment	Sets the switch mode for Mode SW
	Src	Off...Tempo	Selects a modulation source for Mode SW Mode
h	Speed SW	Slow, Fast	The Rotary Speaker has two basic speeds, and Speed Switch allows you to switch between the two. You can set the speeds of the horn and rotor sections separately for both the Fast and Slow settings, as well as the time that it takes them to speed up and slow down.
	Src	Off...Tempo	Selects a modulation source for Speed SW
i	Speed SW Mode	Toggle, Moment	Sets the switch mode for Speed SW
j	FastOverridStop	Off, On	<p>When Fast Overrides Stop is enabled, switching the Speed to Fast via modulation will always push the Rotary Speaker into Fast mode – even if it had previously been stopped. Switching the Speed back to Slow will stop it again.</p> <p>When Fast Overrides Stop is disabled, if the speaker is stopped, it will stay stopped regardless of Speed SW > Src.</p>

Horn

k	Fast Speed	0...100	This specifies the speed of the Horn when the Speed SW is set to Fast.
	Slow Speed	0...100	This specifies the speed of the Horn when the Speed SW is set to Slow.
	Acceleration	0...100	This sets how long it takes the Horn to change from the Slow speed to the Fast speed.
	Deceleration	0...100	This sets how long it takes the Horn to change from the Fast speed to the Slow speed.
	Start Accel.	0...100	Start Acceleration sets how long it takes the Horn to come up to speed after the Mode SW has changed from Stop to Rotate.
	Stop Decel.	0...100	Stop Deceleration sets how long it takes the horn to come to rest after the Mode SW has changed from Rotate to Stop.
l	Mic Distance	0...100	The Rotary Speaker model includes two pairs of stereo mics – one pair for the Horn, and the other for the Rotor. This parameter adjusts the distance between the Horn and its microphones. Lower values bring the mics closer to the speaker.
	Mic Spread	0...100	This adjusts the distance between the two Horn microphones, to widen the stereo field. Higher values increase the stereo effect.
m	StopAtStopPhase	Free, Stop	<p>When the Mode SW is set to Stop, the Horn gradually comes to rest pointing one way or another. Stop At Stop Phase allows you to control where it will stop.</p> <p>Free lets it come to rest naturally, at a more or less random spot. The other settings, -180 to +180, let you force it to land in a specific position.</p> <p>The speaker position has a dramatic effect on the tone, so specifying a fixed position allows you to achieve consistent timbral results.</p>
	Stop Phase	-180...+180	Specific stop position when the above parameter is set to Stop.

Rotor			
n	Fast Speed	0...100	This specifies the speed of the Rotor when the Speed SW is set to Fast.
	Slow Speed	0...100	This specifies the speed of the Rotor when the Speed SW is set to Slow.
	Acceleration	0...100	This sets how long it takes the Rotor to change from the Slow speed to the Fast speed.
	Deceleration	0...100	This sets how long it takes the Rotor to change from the Fast speed to the Slow speed.
	Start Accel.	0...100	Start Acceleration sets how long it takes the Rotor to come up to speed after the Mode Switch has changed from Stop to Rotate.
	Stop Decel.	0...100	Stop Deceleration specifies the time it will take for the Rotor to actually come to rest after rotation is switched off. This sets how long it takes the Rotor to come rest after the Mode Switch has changed from Rotate to Stop.
o	Mic Distance	0...100	This adjusts the distance between the Rotor and its microphones. Lower values bring the mics closer to the speaker.
	Mic Spread	0...100	This adjusts the distance between the two Rotor microphones, to widen the stereo field. Higher values increase the stereo effect.
p	StopAtStopPhase	Free, Stop	When the Mode SW is set to Stop, the Rotor gradually comes to rest pointing one way or another. Stop At Stop Phase allows you to control where it will stop. Free lets it come to rest naturally, at a more or less random spot. The other settings, -180 to +180, let you force it to land in a specific position. The speaker position has a dramatic effect on the tone, so specifying a fixed position allows you to achieve consistent timbral results.
	Stop Phase	-180...+180	Specific stop position when the above parameter is set to Stop.

Speaker

q	Horn/Rotor Bal	Rotor, 1...99, Horn	This sets the output balance between the high frequencies of the Horn and the low frequencies of the Rotor.
r	Speaker Sim	Off, On	This enables and disables modeling of the speaker tone. The Speaker Simulator may still affect the tone even when the Rotary Speaker is turned off, depending on the setting of the Speaker Off Out parameter.
	SpeakerType	Natural...Original CX-3	This selects the model used for the speaker simulator. Important: Some Speaker Types have sharp resonances in their frequency responses which may cause higher volumes with specific notes and drawbar settings. If the volume is already high, this can cause clipping at the outputs. If this happens, simply turn down the output level of the effect or the sound.
		Natural	This is based on new analysis of a classic vintage rotary speaker.
		Natural+Direct	This is similar to Natural, but with a bit of the direct signal mixed back in – resulting in greater extension of both high and low frequencies.
		Resonant	This has more mid-frequency bite than Natural, similar to a popular rotary speaker effects pedal.
		Resonant+Direct	Similar to Resonant, but with a bit of direct signal mixed in (see Natural + Direct above).
		Bright	Based on Natural, but with less high-end roll-off for a brighter sound.
		Bright+Direct	Like Bright, but with a bit of direct signal mixed in (see Natural + Direct above).
		Original CX-3	This is the same as the original CX-3 speaker simulator.
s	AmpMatchType	Off, Amp Type 1, 2	Type of amp model. This should usually be the same as the CX-3 Amp, but you are free to experiment by choosing a different amp type here.

FX Mix

t	Wet/Dry	Dry, 1:99...99:1, Wet	Balance between the wet and dry signal
	Src	Off...Tempo	See the list of DMS (Dynamic Modulation Sources) at the beginning of this part
	Amt	-100...+100	Amount of modulation source

- **h: Speed SW > Src**

We've added a special trick for controlling Rotary Speed with JS X (left-to-right movement, which normally controls pitch bend). When the Src is set to JS X, the joystick works like the speaker speed switch on a vintage organ. Move it to the left for Chorale (slow) and to the right for Tremolo (fast).

Reverb

Reverb Hall

This hall-type reverb simulates the reverberation of mid-size concert halls or ensemble halls.

Reverb Smooth Hall

This hall-type reverb simulates the reverberation of larger halls and stadiums, and creates a smooth release.

Reverb Wet Plate

This plate reverb simulates warm (dense) reverberation.

Reverb Dry Plate

This plate reverb simulates dry (light) reverberation.

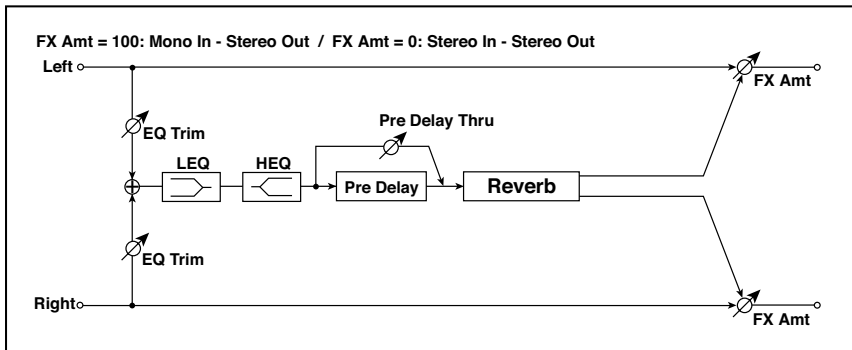

a	Reverb Time [sec]	0.1...10.0	Sets the reverberation time
	High Damp [%]	0...100	Sets the damping amount in the high range
b	Pre Delay [msec]	0...200	Sets the delay time from the dry sound
	Pre Delay Thru [%]	0...100	Sets the mix ratio of non-delay sound

c	EQ Trim	0...100	Sets the EQ input level
d	Pre LEQ Fc	Low, Mid-Low	Selects the cutoff frequency (low or mid-low) of the low-range equalizer
	Pre HEQ Fc	High, Mid-High	Selects the cutoff frequency (high or mid-high) of the high-range equalizer
e	Pre LEQ Gain [dB]	-15.0...+15.0	Sets the gain of Low EQ
	Pre HEQ Gain [dB]	-15.0...+15.0	Sets the gain of High EQ
f	Wet/Dry	Dry, 1:99...99:1, Wet	Balance between the wet and dry signal
	Src	Off...Tempo	See the list of DMS (Dynamic Modulation Sources) at the beginning of this part
	Amt	-100...+100	Amount of modulation source

■ b: Pre Delay [msec]

■ b: Pre Delay Thru [%]

The “Pre Delay” sets the delay time to the reverb input, allowing you to control spaciousness.

Using the “Pre Delay Thru” parameter, you can mix the dry sound without delay, emphasizing the attack of the sound.

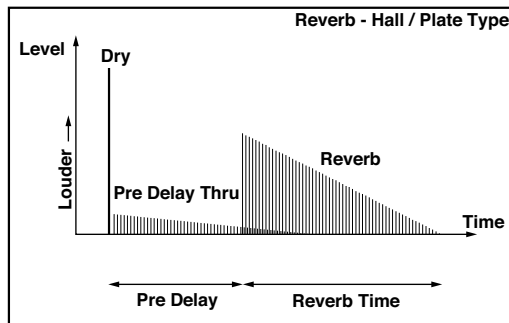

Reverb Room

This room-type reverb emphasizes the early reflections that make the sound tighter. Changing the balance between the early reflections and reverb sound allows you to simulate nuances, such as the type of walls of a room.

Reverb Bright Room

This room-type reverb emphasizes the early reflections that make the sound brighter.

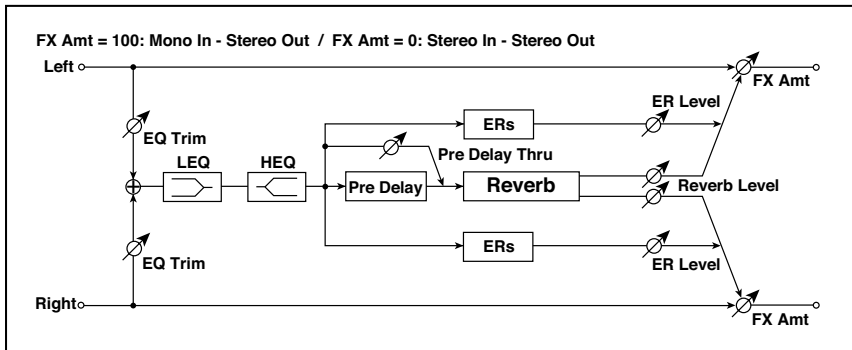

a	Reverb Time [sec]	0.1...3.0	Sets the reverberation time
	High Damp [%]	0...100	Sets the damping amount in the high range
b	Pre Delay [msec]	0...200	Sets the delay time from the dry sound
	Pre Delay Thru [%]	0...100	Sets the mix ratio of non-delay sound
c	ER Level	0...100	Sets the level of early reflections
d	Reverb Level	0...100	Sets the reverberation level
e	EQ Trim	0...100	Sets the EQ input level
f	Pre LEQ Fc	Low, Mid-Low	Selects the cutoff frequency (low or mid-low) of the low-range equalizer
	Pre HEQ Fc	High, Mid-High	Selects the cutoff frequency (high or mid-high) of the high-range equalizer
g	Pre LEQ Gain [dB]	-15.0...+15.0	Sets the gain of Low EQ
	Pre HEQ Gain [dB]	-15.0...+15.0	Sets the gain of High EQ

h	Wet/Dry	Dry, 1:99...99:1, Wet	Balance between the wet and dry signal
	Src	Off...Tempo	See the list of DMS (Dynamic Modulation Sources) at the beginning of this part
	Amt	-100...+100	Amount of modulation source

■ c: ER Level

■ d: Reverb Level

These parameters set the early reflection level and reverb level.

Changing these parameter values allows you to simulate the type of walls in the room. That is, a larger “ER Level” simulates a hard wall, and a larger “Reverb Level” simulates a soft wall.

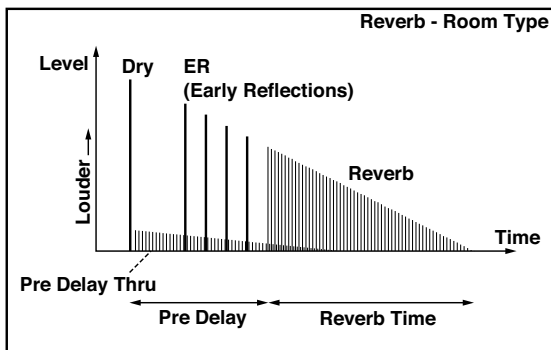

Early Reflections

This effect is only the early reflection part of a reverberation sound, and adds presence to the sound. You can select one of the four decay curves.

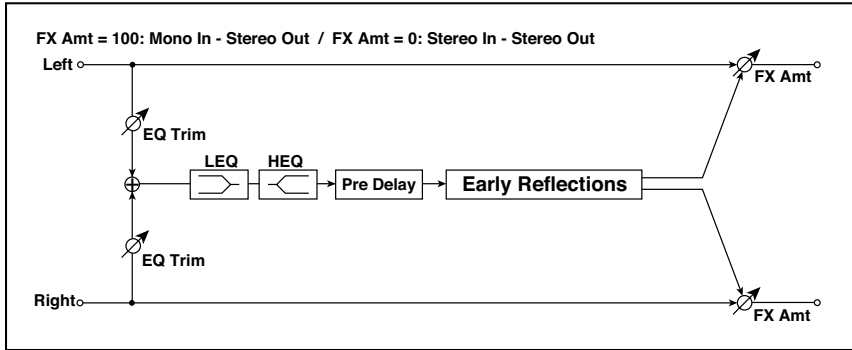

a	Type	Sharp, Loose, Modulated, Reverse	Selects the decay curve for the early reflection
b	ER Time [msec]	10...800	Sets the time length of early reflection
c	Pre Delay [msec]	0...200	Sets the time taken from the original sound to the first early reflection
d	EQ Trim	0...100	Sets the input level of EQ applied to the effect sound
e	Pre LEQ Fc	Low, Mid-Low	Selects the cutoff frequency (low or mid-low) of the low-range equalizer
	Pre HEQ Fc	High, Mid-High	Selects the cutoff frequency (high or mid-high) of the high-range equalizer
f	Pre LEQ Gain [dB]	-15.0...+15.0	Gain of the Low EQ
	Pre HEQ Gain [dB]	-15.0...+15.0	Gain of the High EQ
g	Wet/Dry	Dry, 1:99...99:1, Wet	Balance between the wet and dry signal
	Src	Off...Tempo	See the list of DMS (Dynamic Modulation Sources) at the beginning of this part
	Amt	-100...+100	Amount of modulation source

■ a: Type

This parameter selects the decay curve for the early reflection.

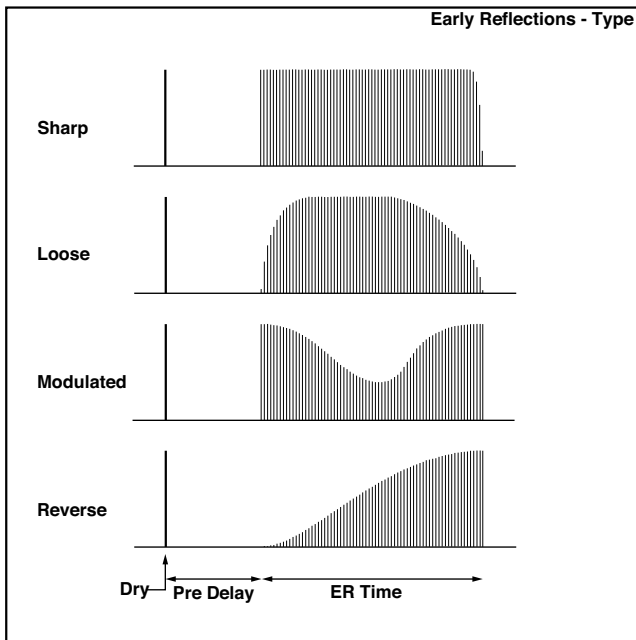

Reverb Gate

This effect combines a mono reverb and a gate.

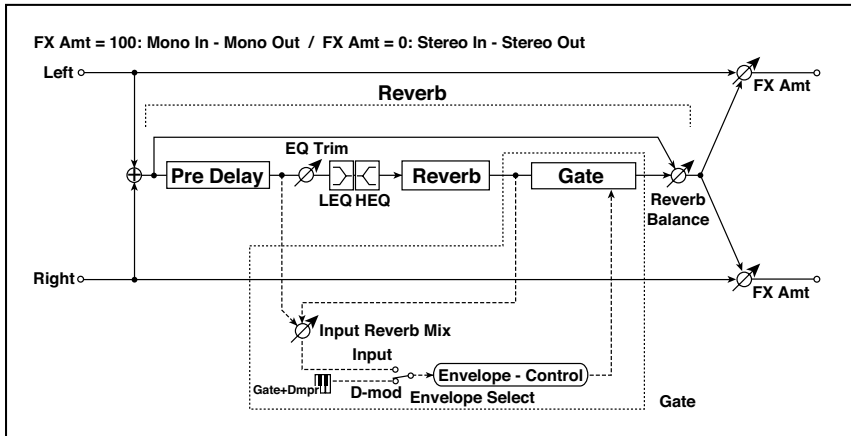

REVERB

a	[R]Reverb Time [sec]	0.1...10.0	Sets the reverberation time
	High Damp [%]	0...100	Sets the damping amount in the high range
b	[R]Pre Delay [msec]	0...200	Sets the delay time of the reverb sound and gate control signal
c	[R]EQ Trim	0...100	Sets the EQ input level
	Reverb Balance	0...100	Sets the reverb effect balance
d	[R]PreLEQ Fc	Low, Mid-Low	Selects the cutoff frequency (low or mid-low) of the low-range equalizer
	Pre HEQ Fc	High, Mid-High	Selects the cutoff frequency (high or mid-high) of the high-range equalizer
e	[R]PreLEQ Gain [dB]	-15.0...+15.0	Sets the gain of Low EQ
	Pre HEQ Gain [dB]	-15.0...+15.0	Sets the gain of High EQ

GATE

f	[G]Envelope Select	D-mod, Input	Switches between modulation source control and input signal control
	Src	Off...Tempo	Selects the modulation source that controls the gate when Envelope Select is set to D-mod
g	[G]Input Reverb Mix	0...100	Sets the balance between the dry and reverb sounds of the gate control signal
	Threshold	0...100	Sets the gate threshold level

h	[G]Polarity	+, -	Switches between non-invert and invert of the gate on/off state
i	[G]Attack	1...100	Sets the attack time
	Release	1...100	Sets the release time
j	Wet/Dry	Dry, 1:99...99:1, Wet	Balance between the wet and dry signal
	Src	Off...Tempo	See the list of DMS (Dynamic Modulation Sources) at the beginning of this part
	Amt	-100...+100	Amount of modulation source

- **f: [G]Envelope Select**

- **f: Src**

- **g: [G]Input Reverb Mix**

- **g: Threshold**

The “[G]Envelope Select” parameter enables you to select whether turning the gate on and off is triggered by the input signal level or controlled directly by the modulation source. You can select from Off to Tempo for the Src parameter to specify the modulation source.

When “[G]Envelope Select” is set to Input, the gate is controlled by the level of signals that are the combination of the dry sound and the reverb sound. When the signal level exceeds the threshold, the gate opens and the reverb sound is output.

Normally, set “[G]Input Reverb Mix” to Dry (the gate is controlled only by the dry sound). If you wish to extend the gate time, set the “[G]Input Reverb Mix” value higher and adjust the “Threshold” value.

Early Reflections Hi Dens

This early reflection effect has more precise early reflections with twice the maximum length of a normal-size effect (Early Reflections). You can create a very smooth and dense sound.

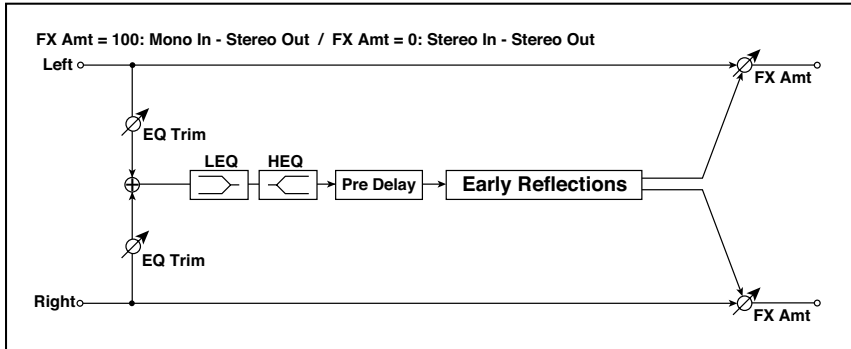

a	Type	Sharp, Loose, Modulated, Reverse	Selects the decay curve for the early reflection
b	ER Time [msec]	10...1600	Sets the time length of early reflection
c	Pre Delay [msec]	0...200	Sets the time taken from the original sound to the first early reflection
d	EQ Trim	0...100	Sets the input level of EQ applied to the effect sound
e	Pre LEQ Fc	Low, Mid-Low	Selects the cutoff frequency (low or mid-low) of the low-range equalizer
	Pre HEQ Fc	High, Mid-High	Selects the cutoff frequency (high or mid-high) of the high-range equalizer
f	Pre LEQ Gain [dB]	-15.0...+15.0	Sets the gain of Low EQ
	Pre HEQ Gain [dB]	-15.0...+15.0	Sets the gain of High EQ
g	Wet/Dry	Dry, 1:99...99:1, Wet	Balance between the wet and dry signal
	Src	Off...Tempo	See the list of DMS (Dynamic Modulation Sources) at the beginning of this part
	Amt	-100...+100	Amount of modulation source

Reverb Spring

The spring-type reverbs have a different sonic character than hall or room-type reverbs. They model the spring reverb systems built into some amps.

ToneLab Reverb Room

This reverb is kept from our VOX ToneLab FX processor. It models the reverberation of a typical room, with numerous early reflections.

a	Time	1...100	Sets the reverb time
	Lo Damp	0...100	Adjusts the attenuation of the low-frequency range
	Hi Damp	0...100	Adjusts the attenuation of the high-frequency range
	Pre Delay	0...70	Sets the initial delay before the reverberation begins. By adjusting this setting you can clarify the definition of the original sound.
b	Wet/Dry	Dry, 1:99...99:1, Wet	Balance between the wet and dry signal
	Src	Off...Tempo	See the list of DMS (Dynamic Modulation Sources) at the beginning of this part
	Amt	-100...+100	Amount of modulation source

O-verb

The O-verb features a high-quality, diffusion-based reverb core. In addition to setting the size of the room, you can model its shape and materials by adjusting the diffusion characteristics of both the initial reflections and the main reverberant wash, and via separate controls for the high, mid, and low decay times. The O-verb also includes randomization, for richer and smoother reverb timbres.

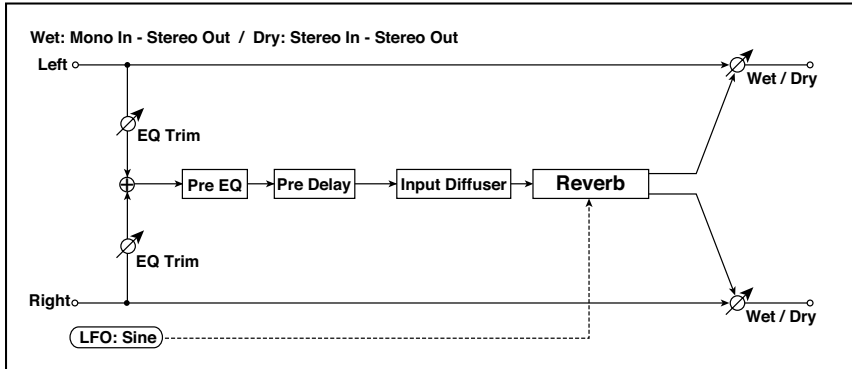

a	Trim	0...100	Sets the EQ input level.
b	Band1 Enable	On, Off	There are two fully parametric bands of peaking EQ, for adjusting the reverb timbre. These affect only the reverb, and not the dry signal. Both bands have identical parameters.
	Band1 Fc [Hz]	200...20.00k	
	Band1 Q	0.5...10.0	
	Band1 Gain [dB]	-18.0...+18.0	
c	Band2 Enable	On, Off	
	Band2 Fc [Hz]	200...20.00k	
	Band2 Q	0.5...10.0	
	Band2 Gain [dB]	-18.0...+18.0	
d	Rolloff	0...100	This controls a lowpass filter on the output of the effect.

e	Pre Delay [msec]	0...1360	Sets the delay time from the dry sound
	Diffusion 1	0...100	Diffusion 1 and 2 soften the sound before it enters the reverb core, shaping the timbre of the initial reflections. Setting both diffusers to around 50 generally produces sufficient diffusion for smooth reverbs; extremely high levels may cause ringing. Some source material, such as vocals, may also benefit from lower settings of diffusion, allowing for more discrete echoes. Diffusion1 and Diffusion2 differ in how the reflections are spaced, and the balance between these two parameters will vary the character of the reverb.
	Diffusion 2	0...100	
f	Size	5...100	Sets the size of the space.
	Diffusion	0...100	This sets the density of reflections within the main reverb. Low settings will produce more discrete echoes, and high settings will produce a smoother reverb. Extremely high settings may cause ringing.
	Reverb Decay	0...100	This sets the main reverberation time. The Damping and Bass Gain parameters, below, let you adjust the decay times separately for the high and low frequencies, respectively.
g	Damping	0...100	This sets the cutoff of the high-frequency damping filter. If Damping is set to 100, the high frequencies will decay at the same rate as the low frequencies; at 0, the high frequencies will decay almost instantly. In real acoustic spaces, high frequencies generally delay somewhat faster than low frequencies, so moderate amounts of damping will create a more realistic sound.
	Bass Crossover [Hz]	20...24.00k	Sets the crossover frequency for the Bass Gain.
	Bass Gain [dB]	-12.0...+6.0	This lets you tailor the decay time of the reverb's low frequencies, using the frequency set by the Bass Xover. Negative settings make the low frequencies decay faster than the main reverb; positive settings make them decay more slowly.
h	Modulation Rate [Hz]	0.10...5.00	Speed of modulation.
	Modulation Depth	0...100	Depth of modulation.
j	Wet/Dry	Dry, 1:99...99:1, Wet	Balance between the wet and dry signal
	Src	Off...Tempo	See the list of DMS (Dynamic Modulation Sources) at the beginning of this part
	Amt	-100...+100	Amount of modulation source

e: Diffusion

Reverb Size, Time, and Diffusion:

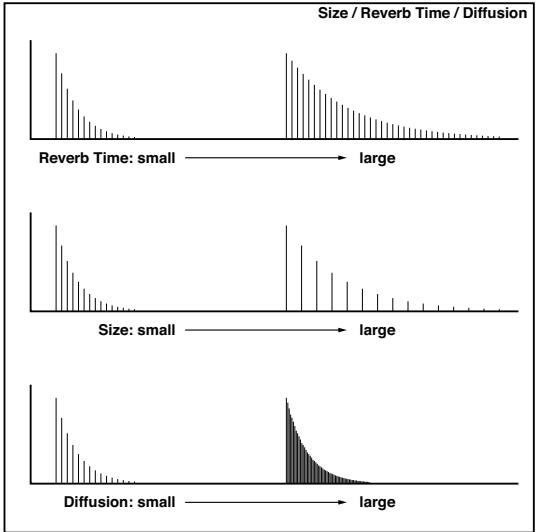

APPENDIX

36

Musical Resources

Keyboard Set Library

This list shows the Factory Keyboard Sets as they appear in the **Keyboard Set Library Select** window.

Piano

Austrian Grand
 German Grand
 Italian Grand
 Japanese Grand
 Classic Grand
 Italian Jazz P.
 Japanese Upright
 Grand Piano Live
 Rock Piano
 Electric Grand 1
 Korg M1 Piano
 Jazz Piano
 Honky-Tonk
 Harpsichord
 Grand Harpsichord
 Clav
 Clav AC
 Cinematic Piano
 A Piano & Blend
 It. Grand Atmo
 Upright Piano
 Saloon Piano
 Rubber Upright
 Harpsi & Orch.
 Clav BD
 Grand & Ensemble
 Grand & Orch.
 Grand & Pad
 Piano & VPM
 Piano & Warm Synth
 Piano & SynVoice
 Piano Atmosphere
 Midi Grand & Pad

Piano & Ensemble
 Piano & Strings
 Piano & E.Piano
 Electric Grand 2
 Digital Grand
 It.Grand Stack 1
 It.Grand Stack 2
 Upright Atmos
 Vinyl Upright
 Octave Piano 1
 Octave Piano 2
 Piano & Bass
 Piano Jazz Trio
 Piano & Vibes
 Piano & Scat
 Glide Piano
 Piano & Whistle
 Vibraphone
 Marimba Trill
 Xylophone
 Music Box
 Tropical
 Vibes & Flute

E.Piano

MK I Stage
 MK I Suitcase
 MK II phaser
 MK II Stage
 MK II Suitcase
 MK V Bright
 MK V Stage
 Dyno E.Piano 1
 Electric Piano

Suitcase Tremolo
 Wurlly line Trem.
 Wurlly mic Trem.
 Amp. Wurlly
 Vintage Wurlly
 Clean Wurlly 1
 Clean Wurlly 2
 Natural Wurlly
 Amp&Comp.Wurlly
 Wurlly Tremolo
 Wurlly & Pad
 FM E.Piano 1
 FM E.Piano 2
 FM E.Piano 3
 FM Classic Piano
 FM Atmosphere
 Digital E.P. Bld 1
 Digital E.P. Bld 2
 FM Dark
 FM Piano chorus
 Digital E.Piano
 Ballad E.Piano
 Tremolo E.Piano
 Pure Suitcase EP
 Bell Tine E.P.
 Jazz Club E.P.
 Stage E.Piano
 Comp&Phaser E.P.
 Dyno E.Piano 2
 Chorus E.Piano
 Classic E.Piano
 Pure Stage EP
 E.P. Atmosphere
 E.Piano & Pad

E.Piano & Strings
 StageEP Atmosph
 Suitcase Atmosph
 R&B E.Piano
 Distorsion E.P.
 Phaser E. Piano
 Suitcase Chorus
 Stage EP Amp/Cho
 Stage EP Amp
 Stage EP Chorus
 Stage EP DynoMy
 Stage EP Phaser
 Stage EP Tremolo
 Wurlly Chorus
 Pure Wurlly
 Hybrid E.Piano 1
 Hybrid E.Piano 2

Organ

DWB Famous Y+
 DWB Jazz 1 Y+
 DWB Jazz 2 Y+
 DWB Perc 4' Y+
 DWB Full 1 Y+
 Jimmy Organ
 Gospel Organ
 BX3 Hi Perc.
 Tutti A
 Harmonica 1
 DWB Jazz 3 Y+
 DWB Deep Perc Y+
 DWB Full 2 Y+
 DWB Class. 1 Y+
 DWB Class. 2 Y+

Distortion Organ
 Rock Organ
 Jazz Organ Y+
 Tutti B
 Toots Harmonica
 DWB Class. 3 Y+
 DWB Class. 4 Y+
 DWB Jazz 4 Y+
 DWB Jazz 5 Y+
 DWB Jazz C# Y+
 Hot BX3 Y+
 BX3 4 Layers V.
 Theatre Organ 1
 Full Pipes
 Harmonica 2
 DWB Jazz D Y+
 DWB Jazz D# Y+
 DWB Upp C# Y+
 DWB Upp D Y+
 DWB Upp D# Y+
 DWB Upp E Y+
 DWB Upp F Y+
 DWB Upp F# Y+
 DWB Upp G Y+
 DWB Upp G# Y+
 Click Organ Y+
 BX3 Jazz Org. V.
 Dark Organ V.
 Full Organ
 Theatre Organ 2
 Blues Harmonica
 Harmonica 3
 Pipe Flute
 Sesquialtera
 Plenum A
 Plenum B
 Plenum C
 Plenum D
 Plenum E
 Pipe Cornet
 Viola+Cornet
 Principal 8'

Pipe Flute 8'
 Gamba 8'
 Trumpet Pipes
 Pipe Octave
 Pipe Super Oct.
 Pipe Fifth
 Principal+Flute
 Nazard A
 Nazard B
 Flute8'+Flute4'
 Flute8'+Flute2'
 Gamba+Flute
 Celeste
 Princ 1 - 2 man.
 Princ 2 - 2 man.
 Princ 3 - 2 man.
 Princ 4 - 2 man.
 Flute 1 - 2 man.
 Flute 2 - 2 man.
 Nazard - 2 man.
 Terziana - 2 man
 Cornet - 2 man.
 Larigot - 2 man.
 Trumpet - 2 man.
 Plenum1 - 2 man.
 Plenum2 - 2 man.
 Tutti - 2 man.

Guitar

Real Nylon Gtr
 Nylon Gtr & Pad
 Nylon Guitar
 Natural SteelGtr
 Steel Gtr & Strings
 Clean Ch.Guitar
 Famous Guitar1
 Overdrive Gtr1
 Clean El.Guitar
 Jazz Guitar
 Nylon Gtr & Fret
 Unplugged Gtrs
 Folk Guitar

12 Str Folk Gtr
 Real Dobro
 Famous Guitar2
 Famous Guitar3
 Overdrive Gtr2
 Overdrive Gtr3
 Jazz Club Guitar
 Pat Guitar Synth
 Distortion Gtr
 Overdrive Gtr V.
 Crunch Gtr DNC
 Rock & Roll Gtr
 Wah Guitar Y+
 Flute&Gtr Synth
 Western Gtr&Whis
 Guitar & Whistle
 AmbienceE.Guitar
 Shadow Guitar
 Gtrs Atmosphere
 George Gtr&Scat
 Guitar Club

Strings

Nat. Violin
 Nat. Viola
 Nat. Cello
 Nat. Contrabass
 Soprano Voice
 Real Strings DNC
 Choir & Soprano
 Movie Orchestra
 Big Choir & Orch
 Cinematic + Sub
 Violin virtuoso
 Jazz Violin
 Violin Strad.
 Real new Viola
 A Cappella
 Bell & Strings
 Theatre Strings
 Epic Sound
 Room Strings

Choir & Scat
 Real Violin
 Real new Violin
 Serenade Violin
 eXp Viola
 ScatVoice & Bass
 Movie Strings
 Vocal Brass
 Strings & Orch.
 Strings & Vocal
 Movie Action
 CinematicStrFast
 Single room Str
 Orchestra Tutti
 Soft Strings
 Marcato Strings
 Strings Tutti
 Soprano & Strings
 Natural String
 Scat Voices
 Slapstick Pizz.
 Small Orchestra
 Smooth Orchestra
 Soprano Choir
 Studio Strings
 Vienna Strings
 Wiener StringPad
 Dreaming Choir
 Vocal & Str. Ens
 Oboe & Str. Ens.
 Vocoder 1
 Vocoder 2
 Vocoder 3
 Vocoder 4

Brass

Shake Brass1 Y+
 BigBand Brass
 Orchestral Brass
 SaxEns.& Brass V
 Cup & Mute Brass
 Horn Section

Smooth Band RX	Band Trumpet V.	Woodwind	Bros Buzz Y+
Warm Brass	Muted Atmo	Latin Flute	Caos Synth
Muted Ensemble	Muted Trp. Band	Natural Clarinet	Dance Syn Perc
Ballad Brass	Jazz Trombone 1	Folk Clarinet	Distonic Lead
Shake Brass2 Y+	Trump.& Clarinet	Recorder	Distortion Synth
Sax & Brass Ens	Miles Trp Leg. 1	Xaphoon	Dubstep Synth
Swell Brass DNC	Miles Trp Leg. 2	Concert Flute	Fat Synth + Sub
MorphAttackBrass	Club Sax & Trp	Clarinet	Fifth Bass
Smooth Band	Jazz Trombone 2	Kletzmer Clarinet	Fing.GlideSquare
Cup Mute Brass	Jazz Trombone 3	Panflute	Folk EDM
Brass Overtone	Cornet & Strings	Shakuhachi	Formant Lead
Club Sax & Muted		Jazz Flute	Gliding Lead
Club Brass Sect.	Sax	Real Clarinet	Groove SynthGtr.
Sforzato Brass	Nat. Tenor Sax	Soft Clarinet	Grubby Mod
Horns & Strings	Nat. Alto Sax 1	Cool Oboe 1	Hybrid Lead
BigCountry Horns	Nat. Bari Sax	Robin Whistle	JP8
Cornet & Sax Ens	Nat. Soprano Sax	Classic Flute	Meta Echo
Cornet&Brass Ens	Super Sax Sect.1	Dixie Clarinet	Mini Lead
Sax & Cornet Ens	Tenor Jazz Sax 1	Clarinets & RX	ModuLead
	Jazz Sax	Bottle Flute	Next Dance
Trumpet	Jazz Baritone	Whistle	Next Glide
Nat. Trumpet	Kenny Soprano	Frullato Flute	Next Octave
Miles Muted Trp	Super Sax Sect.2	Flutes&Clarinets	Noise Lead DNC
Wah Trumpet	Nat. Alto Sax 2	Reeds & Trombone	Pilot Lead
Fluge Horn	Tenor Sax 1	Cool Oboe 2	Portamento Lead
Nat. Trombone 1	Tenor Sax 2	March Whistle	Prophy Lead
Cornet Legato	Soprano Pad	Flute & Strings	Robert Bass
Trumpets Atmo	Super Sax Sect.3	Flute & Muted	Saw Solo
Cup Trumpet	Tenor Jazz Sax 2	Panflute & Synth	Square & Pulse
Mex. Trumpet	Soft Latin Sax	eXp Whistle	Square Razor
Hard Trombone	Sweet Alto Sax 1	Whistling Rain	Square Solo
JazzTrumpet Leg.	Soprano Sax		Stack Attack
Jazz Trumpet	Sax & Brass V.	Synth	Symph Synth
Cornet & Growl	Jazz Tenor Sax	16-8-4 & Sub32	Synth Bass Clarinet
Sweet Flugel	Super Tenor Sax	Analog Lead	Synth Whooo
Nat. Trombone 2	Sweet Alto Sax 2	Analog Synth	Talking Lead
Miles Trp FX	Breath Tenor Sax	ARP 2600 Echo	Tekno City
Jazz Cornet Muted	Saxs Section	ARP 2600 PWM	Thin PulSeq DNC
Dixie Trumpet	Alto Sax	Big Lead Sine	Triangle Solo
Trumpet Delay	Miller Serenade	Big Lead	Tube Synth Bass
Soft Trombone	Sax Ensemble	Big One	Unison Attack
Folk Trumpets	Sax Sect. & Trp	Big Side Attack	Voice EDM

Waky Lead	Bellsynth	Side Chain Loft	Real Banjo
Widebass	Brite & Big Pad	Solaris	Sitar
80's Mellow	Eastern Depths	Space Trailer	Berimbau
80's Super Pad	Evoling Pad	SQ Natur	It.Acc.16'+8'+4'
Cosmic Sweep	Evolving Jungle	Staples	It. Acc. 8'+4'
Dance Basic	Far Memories	Step Sequencer	It. Accordion 4'
Dark Stack	Fisarmony	The Life Day	Bandoneon+Short
Double Sweep	Hans Sound	Trigger 88	Astor Bandoneon
Dream Pad	Ipnotic bpm	Vangel Sound	Mandolin Tremolo
EDM Synth	Landscape	Waterland	Napoli Mandolin
Fresh Pad	Layers Enjoy	Wave Echoes	Hawaiian Guitar
Leadscape	Little Beatles	Wave obsession	IndianFret.&Nay
Lfo Sound bpm	Meditation Stack	Wave Sequence	Oriental Feel
Mellow Perc. Pad	Mixed Echoes	Wave Synth	It.Acc.& Strings
Moon Pad	Movie Stack 1	Wide Attack	Bell & Accordion
Pa800 Pad	Movie Stack 2		Cassotto
Poly6 + JP8	Movie Stack 3	World	Alps Accordion
Rhythmical Synth	Movie Stack 4	It. Accordion16'	Melodica
S&H Pad	My Sequencer	It. Accordion 8'	PiccoloAccordion
Spire Synth	Nighthawk	It. Acc. 16'+8'	Master Fisa
Synth Yes	Pacific Sea	It. Acc. 16'+4'	ItalianAccordion
Talking Pad	Pisco Pad	Musette	Clarinet Accord.
Trinity Pad	Rhythmsfere	Mandolin	Acc. & Bass Acc.
Aereosonic	Running bpm	Mandolins Orch.	Pedal Steel Gtr

Sounds

The following table lists all Factory Sounds as they appear in the **Sound Select** window. The table also includes MIDI data used to remotely select the Sounds. **CC00**: Control Change 0, or Bank Select MSB. **CC32**: Control Change 32, or Bank Select LSB. **PC**: Program Change.

Sound	CC00	CC32	PC
Factory/Piano			
Austrian Grand	121	20	0
Japanese Grand	121	7	1
German Grand	121	13	0
Italian Grand	121	16	0
Japanese Upright	121	13	1
Upright Piano	121	15	0
Live Grand	121	6	1
Rock Baby Grand	121	8	0
Electric Grand 1	121	14	2
Cinematic Grand	121	19	0
Austr Grand Dry	121	23	0
Japan Grand Dry	121	11	1
German Grand Dry	121	3	0
Italian Grand Dry	121	17	0
Japan Upr Dry	121	18	1
Pop Upright	121	14	0
M1 Piano 1	121	16	2
Bright Baby Grand	121	5	1
Electric Grand 3	121	12	2
Hybrid Grand	121	10	6
Grand & Strings	121	7	0
Grand & Pad	121	9	0
Grand & Layer 1	121	9	2
Grand & Layer 2	121	13	2
Grand &Tine	121	8	2

Sound	CC00	CC32	PC
Grand & FM 1	121	17	2
Grand & FM 2	121	7	2
Grand & Vibes	121	6	0
Midi Grand & Pad	121	4	1
Upright Layer	121	6	2
Clavinet AC	121	13	7
Clavinet AD	121	14	7
Clavinet BC	121	15	7
Clavinet BD	121	16	7
VintageClavi1DNC	121	7	7
Clavi AC Detuned	121	9	7
Clavi AD Detuned	121	10	7
Clavi BC Detuned	121	11	7
Clavi BD Detuned	121	12	7
VintageClavi2DNC	121	8	7
Japan Honky-Tonk	121	9	3
Honky-Tonk Piano1	121	2	3
Honky-Tonk Piano2	121	11	3
Ragtime Piano	121	3	3
Saloon Piano 1	121	10	3
Grand Harpsichord	121	9	6
Harpsichord 1	121	7	6
Harpsichord 2	121	8	6
Electric Grand 2	121	15	2
M1 Piano 2	121	2	2
Austrian Classic	121	21	0

Sound	CC00	CC32	PC
Austrian Jazz	121	22	0
Austr Solo Grand	121	24	0
Austrian Grand RX	121	25	0
Italian JazzGrand	121	18	0
Japanese Classic	121	8	1
Japanese Jazz	121	9	1
Japan Grand Solo	121	10	1
Japanese Grand RX	121	12	1
Prepared Grand 1	121	5	3
German Clas Grand	121	4	0
German Jazz Grand	121	5	0
German Grand Solo	121	11	0
German Pop Grand	121	12	0
German Warm Grand	121	10	0
Japan Upr Bright	121	14	1
Japan Upr Dark 1	121	15	1
Japanese Upr Det	121	16	1
Japan Upr Dark 2	121	17	1
Japan Upright RX	121	19	1
Prepared Grand 2	121	6	3
Prepared Grand 3	121	7	3
Prepared Grand 4	121	8	3
Factory/Electric Piano			
MK I Stage	121	46	4
MK I Suitcase	121	47	4
MK I Dyno	121	53	4
MK II Stage	121	49	4
Wurly Line Out	121	56	4
MK V Stage	121	51	4
MK II Suitcase	121	50	4
Tine EP Classic 1	121	45	4
Tine EP Classic 2	121	9	5
TineEP88 Suitcase	121	34	4
Tine EP Phaser	121	27	4

Sound	CC00	CC32	PC
Tine EP Dyno	121	28	4
Tine EP Amp/Phas	121	29	4
MK V Bright	121	52	4
Tine EP Wet	121	31	4
Tine EP Distorted	121	30	4
Tine EP Bell	121	32	4
Tine EP Thin	121	9	4
Tine EP Damper	121	25	4
Tine EP	121	18	4
Tine EP Club	121	11	4
Tine Suitcase 1	121	20	4
Tine Suitcase 2	121	21	4
Tine Hybrid	121	8	4
Tine EP & Pad	121	1	94
Wurly Amp	121	38	4
Wurly Tremolo 1	121	39	4
Wurly Tremolo 2	121	16	4
Wurly Clean 1	121	41	4
Wurly Clean 2	121	37	4
MK II Stage Dry	121	54	4
MK II SuitcaseDry	121	55	4
Tine EP Dry	121	43	4
Wurly Line Dry	121	60	4
Wurly Mics Dry	121	61	4
Wurly Dry 1	121	48	4
Wurly Dry 2	121	44	4
Wurly Classic 1	121	17	4
Wurly Classic 2	121	12	4
Wurly Amp/Comp	121	40	4
FM Piano Dark	121	31	5
FM Hybrid	121	32	5
FM Piano Soft	121	33	5
FM Piano&Pad	121	34	5
Synth Piano 1	121	35	5

Sound	CC00	CC32	PC
FM Tine 1	121	18	5
FM Tine 2	121	19	5
FM Tine 3	121	17	5
FM Tine 4	121	14	5
Wurly Logic	121	36	4
FM Piano 1 RM	121	20	5
FM Piano 2 RM	121	21	5
FM Piano 3	121	22	5
FM Piano 4	121	23	5
FM Piano 5	121	24	5
FM Piano 6	121	25	5
FM Piano 7	121	26	5
FM Piano 8	121	27	5
FM Piano 9	121	28	5
FM Piano 10	121	29	5
FM Piano 11	121	30	5
DW8000 EP	121	11	5
Wurly Mics	121	57	4
Wurly Mic R	121	58	4
Wurly Mic L	121	59	4
MK II Line RX	121	62	4
MK II Mic RX	121	63	4
E. Piano Noise	121	35	4
Wurly Noise	121	42	4
Factory/Mallet & Bell			
Vibraphone 1	121	2	11
Marimba	121	7	12
Marimba Key Off	121	2	12
Balaphon	121	6	12
Xylophone Y-	121	2	13
Xylophone	121	1	13
Glockenspiel	121	2	9
Music Box	121	2	10
Sistro	121	1	9

Sound	CC00	CC32	PC
Steel Drum Y-	121	9	114
Steel Drum	121	1	114
Cymbalon DNC	121	2	15
Santur	121	1	15
Kalimba 1	121	2	108
Kalimba 2	121	1	108
Celesta	121	1	8
Orgel	121	1	10
Bells	121	3	14
Tubular Bells	121	4	14
Synth Bells	121	2	98
Synth Marimba 1	121	10	12
Synth Marimba 2	121	9	12
Synth Marimba 3	121	8	12
Synth Mallets 1	121	2	114
Synth Mallets 2	121	4	114
Synth Mallets 3	121	5	12
Factory/Accordion			
Harmonica 1 DN1	121	11	22
Harmonica 1 DN2	121	12	22
Harmonica 2 DN1	121	13	22
Harmonica 3 DN1	121	14	22
Bandoneon DNC	121	11	23
Italian Acc 16'	121	31	21
Italian Acc 8'	121	32	21
Italian Acc 4'	121	33	21
Italian Acc 16' Bass	121	34	21
Tango Accordion 1	121	10	23
Bandoneon Sync	121	12	23
Bandoneon Short	121	13	23
Classic Musette	121	29	21
French Musette	121	18	21
2 Voices Musette	121	16	21
3 Voices Musette	121	17	21

Sound	CC00	CC32	PC
Master Acc 1	121	8	21
Tango Accordion 2	121	1	23
Acc 1 16' + 4'	121	7	21
Acc 1 16' + 8'	121	6	21
Cassotto 16'	121	12	21
Accordion 1	121	24	21
Acc 2 16' + 4'	121	7	23
Acc 2 16' + 8'	121	2	23
Acc 2 16'+8'+4'	121	8	23
Acc Clarinet	121	19	21
Acc Piccolo	121	21	21
Acc Bass	121	5	23
Acc & Acc Bass	121	9	23
Acc 16'+8' & Bass	121	4	23
Melodica	121	15	22
Cinematic Acc	121	35	21
Steirische Acc 1	121	25	21
Steirische Acc 2	121	26	21
Factory/Organ			
DRAWBARS	121	127	16
Jimmy Organ	121	13	18
Percussion Org 1	121	9	17
Percussion Org 2	121	11	17
BX3 Rock 1	121	14	18
BX3 Rock 2	121	15	18
BX3 Rock 3	121	16	18
BX3 Rock 4	121	17	18
BX3 Full	121	6	16
BX3 Jazz 1	121	20	16
BX3 Jazz 2	121	9	18
BX3 Gospel	121	37	16
Gospel Organ	121	38	16
Jazz Organ 1	121	8	16
Lower Perc Organ	121	4	17

Sound	CC00	CC32	PC
Lower Organ 1	121	39	16
Lower Organ 2	121	15	16
Theatre Organ 1	121	30	16
Theatre Organ 2	121	22	16
Theatre Organ 5	121	23	16
Jazz Organ 2	121	12	17
VOX Legend	121	11	16
60's Organ	121	40	16
Pianola	121	6	20
Tutti A	121	11	19
Tutti B	121	12	19
Sesquialtera	121	13	19
Plenum A	121	14	19
Plenum B	121	15	19
Plenum C	121	16	19
Plenum D	121	17	19
Plenum E	121	18	19
Pipe Cornet	121	19	19
Viola + Cornet	121	20	19
Principal 8'	121	21	19
Pipe Flute 8'	121	22	19
Gamba 8'	121	23	19
Trumpet Pipes	121	24	19
Pipe Octave	121	25	19
Pipe Super Oct.	121	26	19
Pipe Fifth	121	27	19
Principal + Flute	121	28	19
Nazard A	121	29	19
Nazard B	121	30	19
Flute8' + Flute4'	121	31	19
Flute8' + Flute2'	121	32	19
Gamba + Flute	121	33	19
Celeste	121	34	19
Terziana	121	35	19

Sound	CC00	CC32	PC
Larigot	121	36	19
Pluck Organ	121	14	17
Plenum Vacui	121	37	19
Synth Drone	121	38	19
Harmonic Organ	121	7	20
Factory/Guitar			
Classic Gtr 1 DNC	121	29	24
Classic Gtr 2 DNC	121	20	24
Classic Gtr 3 DNC	121	18	24
Spanish Guitar	121	6	24
7 Str. Guitar DNC	121	28	24
Steel Guitar1 DNC	121	47	25
Steel Guitar2 DNC	121	48	25
Steel Guitar3 DNC	121	49	25
Steel Guitar4 DNC	121	51	25
Steel Guitar5 DNC	121	36	25
Strat N DI DNC	121	39	27
Strat N CIn DNC	121	38	27
Strat N DI Mute	121	23	28
Strat N CIn Mute	121	22	28
Chorus Guitar 1	121	3	27
Strat B DI DNC	121	45	27
Strat B Ovd DNC	121	5	29
Strat B DI Mute	121	28	28
Strat B Ovd Mute	121	6	29
Chorus Guitar 2	121	18	27
LesP M DI DNC	121	43	27
LesP M CIn DNC	121	42	27
LesP M DI Mute	121	27	28
LesP M CIn Mute	121	26	28
Single Coil Gtr	121	14	27
33X B DI DNC	121	44	27
33X B Dst DNC	121	17	30
33X B DI Mute	121	29	28

Sound	CC00	CC32	PC
33X B Dst Mute	121	18	30
Production E Gtr	121	35	27
Tele M DI DNC	121	41	27
Tele M CIn DNC	121	40	27
Tele M DI Mute	121	25	28
Tele M CIn Mute	121	24	28
Power Chords	121	15	30
Jazz Guitar DNC	121	8	26
Jazz Guitar Clean	121	23	27
Jazz Guitar Octav	121	9	26
Dobro DNC	121	50	25
Wah Guitar	121	30	28
Strat UpDown DNC	121	33	27
Strat Mutes Y-	121	31	28
Mute OD Guitar	121	32	28
Palm Open E Gtr	121	33	28
Gtr Harmonic Pad	121	3	31
Distorted Gtr1DNC	121	16	30
Distorted Gtr2DNC	121	14	30
Crunch Gtr DNC	121	3	29
Stereo Dist.Gtr	121	8	30
Synth Guitar	121	10	26
Folk Guitar DNC	121	34	25
Steel Guitar6 DNC	121	19	25
12 Str Guitar DNC	121	33	25
Viola Caipira DNC	121	45	25
Factory/Strings & Vocal			
StringEnsembleDNC	121	13	49
Soft Strings	121	20	49
Movie Strings 1	121	29	48
Movie Strings 2	121	25	48
Studio Strings	121	19	49
Ballad StringsDNC	121	17	49
Ballad Strings	121	18	49

Sound	CC00	CC32	PC
Spiccato Strings	121	14	49
Staccato Strings	121	15	49
Marcato Strings	121	16	49
Tremolo Strings	121	2	44
Pizzicato Strings	121	4	45
PizzicatoStrings2	121	2	45
Strings&Glockensp	121	18	48
String Quartet 1	121	31	48
String Quartet 2	121	26	48
String Quartet 3	121	27	48
Strings & Vocal	121	30	48
Strings & Horns	121	15	48
OrchestraTutti 1	121	14	48
Full Orchestra	121	24	48
Orchestra & Oboe1	121	16	48
Orchestra & Flute	121	20	48
Movie Orchestra	121	28	48
Movie Ensemble	121	11	53
Violin 1 DN2	121	15	40
Violin 2 DN1	121	16	40
Violin 3	121	17	40
Violin 4	121	18	40
Violin 5 DN1	121	14	40
Violin 6 DN2	121	13	40
Violin 7 DN1	121	12	40
Violin 8 DN2	121	10	40
Violin 9 DN2	121	11	40
Viola 1 DN2	121	4	41
Viola 2 DN1	121	5	41
Viola 3 DN1	121	3	41
Viola 4	121	1	41
Cello 1 DN2	121	3	42
Cello 2 DN1	121	4	42
Cello 3	121	2	42

Sound	CC00	CC32	PC
Double Bass 1 DN2	121	3	43
Double Bass 2 DN1	121	4	43
Double Bass 3	121	2	43
Harp	121	2	46
Full Choir	121	25	52
Hmm Choir	121	13	53
Lyrical Choir	121	9	53
Ooh Voices Slow	121	3	52
Ooh - Ah Voices	121	9	52
Treble Voices	121	23	52
Ooh Voices	121	6	52
Movie Choir	121	10	53
Firemen Choir	121	24	52
MouthClosed Choir	121	7	54
Soprano Vox 1	121	7	53
Soprano Vox 2 DNC	121	4	53
Soprano Vox 3	121	8	53
Soprano Vox Pad	121	12	53
Scat Voices 1	121	27	52
Scat Voices 2	121	14	52
Scat Voices 3	121	21	52
Scat Voices&Bass1	121	26	52
Scat Voices&Bass2	121	17	52
Choir&Scat Voices	121	28	52
Synth Strings 1	121	5	50
Synth Strings 2	121	6	50
Synth Voices Pad1	121	6	54
Synth Voices Pad2	121	9	91
Pad Choir	121	14	53
Vocalscape	121	3	54
Fresh Breath	121	7	91
Heaven	121	3	91
Airways	121	3	53
Synth Vox Lead	121	8	54

Sound	CC00	CC32	PC
Factory/Trumpet & Trombone			
Trumpet 1 DN2	121	38	56
Trumpet 2 DN1	121	39	56
Trumpet 3 DN2	121	40	56
Jazz Trumpet DN1	121	33	56
Jazz Trumpet DN2	121	34	56
MexicoTrumpet1DN2	121	41	56
MexicoTrumpet2DN2	121	42	56
Mute Trumpet1 DN1	121	11	59
Mute Trumpet2 DN2	121	10	59
Mute Trumpet3 DN2	121	9	59
Mute Trumpet 4	121	5	59
Mute Trumpet5 DN1	121	6	59
Mute Trumpet6 DN1	121	7	59
Wah Trumpet 1 DN1	121	12	59
Wah Trumpet 2	121	2	59
Concert Trumpet	121	19	56
Jazz Cornet DN1	121	32	56
Jazz Cornet DN2	121	36	56
Mute Cornet DN1	121	8	59
Flugelhorn 1 DN2	121	37	56
Flugelhorn 2	121	12	56
Trombone 1 DN1	121	26	57
Trombone 2 DN2	121	27	57
Trombone 3 DN2	121	28	57
Jazz Trombone DN1	121	20	57
Jazz Trombone DN2	121	21	57
Soft Trombone DN1	121	22	57
Soft Trombone DN2	121	23	57
HardTrombone DN1	121	24	57
HardTrombone DN2	121	25	57
French Horn 1	121	11	60
French Horn 2	121	9	60
Tuba 1	121	2	58

Sound	CC00	CC32	PC
Alpine Tuba	121	6	58
Oberkr Tuba	121	1	58
Sousaphone	121	8	58
Euphonium	121	7	58
Factory/Brass			
Swing Horns DNC	121	40	61
Ballade Brass	121	41	61
Horns Swell1 DNC	121	38	61
Horns Swell2 DNC	121	39	61
Big Band Brass 1	121	32	61
Big Band Brass 2	121	4	61
Tight Brass 1	121	27	61
Tight Brass 2	121	29	61
Trumpets & Horns	121	5	60
Trumpets & Tromb	121	34	61
Tight Brass 3	121	2	61
Brass of Power	121	30	61
Movie Brass	121	20	61
Expressive Brass	121	15	61
Glenn & Friends	121	3	61
French Section	121	2	60
French Horns	121	10	60
Soft Horns	121	8	60
Trombones DNC	121	10	61
Trumpets DNC	121	42	61
Trumpets Har Mute	121	43	61
Trumpets Cup Mute	121	44	61
Mute Ensemble 1	121	3	59
Mute Ensemble 2	121	4	59
Flute & Muted	121	6	73
Synth Brass	121	5	62
Electrik Brass	121	4	62
Horns Swell3 DNC	121	45	61
Pulse Brass	121	7	62

Sound	CC00	CC32	PC
Factory/Sax			
Soprano Sax 1 DN2	121	7	64
Soprano Sax 2 DN1	121	6	64
Alto Sax 1 DN2	121	26	65
Alto Sax 2 DN2	121	27	65
Alto Sax 3 DN2	121	28	65
Alto Sax 4 DN1	121	22	65
Alto Sax 5 DN1	121	23	65
Alto Sax 6 DN1	121	24	65
Jazz Sax DN1	121	20	65
Jazz Sax DN2	121	21	65
Tenor Sax 1 DN2	121	23	66
Tenor Sax 2 DN1	121	16	66
Tenor Sax 3 DN2	121	17	66
Tenor Sax 4 DN1	121	19	66
Tenor Sax 5 DN2	121	20	66
Soft Tenor DN1	121	21	66
Soft Tenor DN2	121	22	66
Tenor Growl DN1	121	18	66
Baritone Sax1 DN2	121	7	67
Baritone Sax2 DN1	121	6	67
Sax Quartet	121	29	65
Sax Ensemble 1	121	11	65
Sax Ens. Legato	121	19	65
Sax Ens. Leg+Sfz	121	25	65
Factory/Woodwind			
Clarinet 1 DN2	121	24	71
Clarinet 2 DN1	121	21	71
Folk Clarinet DN2	121	25	71
Jazz Clarinet DN1	121	22	71
Klezmer Clar1 DN2	121	26	71
Klezmer Clar2 DN1	121	27	71
Concert Flute DN1	121	15	73
Concert Flute DN2	121	16	73

Sound	CC00	CC32	PC
Latin Flute DN1	121	17	73
Latin Flute DN2	121	18	73
Piccolo	121	3	72
Oboe 1	121	5	68
Oboe 2	121	3	68
Oboe 3	121	1	68
Bassoon 1 DNC	121	2	70
Bassoon 2	121	1	70
Recorder 1	121	3	74
Ocarina	121	1	79
Pan Flute DN1	121	5	75
Shakuhachi 1	121	2	77
Shakuhachi 2	121	3	77
Blown Bottle	121	1	76
Whistle 1 DN1	121	6	78
Whistle 2	121	7	78
Clar & Sax Ens 1	121	17	71
Clar & Sax Ens 2	121	18	71
Reeds & Saxes	121	10	71
Small Orchestra	121	1	72
Xaphoon	121	23	71
Factory/Synth Pad			
Solaris Pad	121	11	92
Synth Bells Pad	121	10	92
Daylife Pad	121	8	92
SynthFretless&Pad	121	9	92
Nature Pad	121	7	92
Blend Pad	121	4	94
Blend & Sub Pad	121	5	94
Bubbles Pad	121	3	92
Flutter Pad	121	4	92
Little Beetle Pad	121	5	92
Staples Pad	121	6	92
Dune Pad	121	2	94

Sound	CC00	CC32	PC
Vangelis Pad	121	3	94
Swam Noise Pad	121	10	95
Jungle Pad	121	9	97
Pat Fretless	121	13	99
Wave Obsession	121	7	101
Side Chain Loft	121	10	102
Stories Pad	121	11	102
Bright Hoover Pad	121	11	88
Symphonic Pad	121	21	89
Big & Brite Pad	121	20	90
SolOr Pad Y-	121	21	90
Fast Phat Slow Y-	121	22	90
Octave Pad	121	23	90
Intermodulations	121	5	93
Sun Sweep	121	6	101
Sci-Fi Pad	121	2	103
Vintage Space Pad	121	3	103
Pacific Sea Pad	121	6	88
Waterland Pad	121	9	88
Wave Echoes Pad	121	6	102
Layers Enjoy Pad	121	11	99
Meditation Stack	121	10	88
Hypnotic Stack	121	12	99
80's Mellow Pad	121	19	89
80's Super Pad	121	20	89
Warm Pad	121	15	89
Square Pad	121	15	90
Dark Pad	121	6	89
Analog Pad 1	121	8	89
Symphonic Ens.	121	14	89
Warm Buzz Pad	121	17	89
Matrix 12 Pad	121	14	90
The Pad	121	4	89
Evolving Pad	121	4	88

Sound	CC00	CC32	PC
Rhythmsphere	121	11	96
Far Muted Atmos.	121	5	88
Far Memories Pad	121	14	91
Atmoschoir Pad	121	15	91
Space Trail Pad	121	1	103
Jurassic Pad	121	3	88
Pisco Pad	121	2	99
Big Side Attack	121	18	89
Tension Scene	121	8	97
Dronas Pad	121	4	93
Moon Cycles	121	5	102
Movie Stack 1	121	4	99
Movie Stack 2	121	5	99
Movie Stack 3	121	6	99
Eastern Depths	121	8	99
S&H Pad DNC	121	10	96
Wave-Sequence	121	4	96
Aerosonic Pad	121	5	96
My Sequencer	121	6	96
Step Sequencer	121	7	96
Big Panner	121	4	63
Choir Sequence	121	13	91
Pop Synth Pad	121	4	91
Air Clouds Pad	121	1	97
Digi Ice Pad	121	2	101
Cinema Pad	121	5	95
Vintage Sweep	121	7	95
Meditative Pad	121	2	95
Super Sweep	121	4	90
Wave Sweep	121	5	90
Next Analog	121	16	89
Cosmic Pad	121	1	93
Bell Pad	121	6	98
Fresh Air 1 Pad	121	2	91

Sound	CC00	CC32	PC
Fresh Air 2 Pad	121	11	91
Future Pad	121	5	91
80's Pop Synth	121	2	93
Blender Pad	121	1	92
Deep Noise Pad	121	4	127
Mixed Echoes Pad	121	16	91
Nighthawk Pad	121	7	88
Mellow Perc Pad	121	8	88
Hans Pad	121	13	96
Running Pad	121	12	96
LFO Sound BPM	121	5	101
Deep Snap Pad	121	7	102
Echo Noise Pad	121	8	102
Formant Bounce	121	9	102
Triangular Layer	121	2	92
Factory/Synth Lead			
Saw Synth RD	121	54	81
MB Triangle RM	121	48	81
MB Saw RM	121	49	81
2 Saws Mono RM	121	50	81
Arp2600 PWM 1&2	121	51	81
PWM 1&2 + Saw	121	52	81
Massive Unison	121	53	81
MB Square RM	121	28	80
Plug Perk Hall	121	13	98
Double Synth	121	47	81
Next Glide EDM	121	29	81
Stack Attack	121	30	81
ModuLead	121	31	81
X-Mod Saw EDM	121	32	81
Dark Stack EDM	121	33	81
Distonic Lead EDM	121	34	81
Spring Lead EDM	121	35	81
Folk EDM	121	16	84

Sound	CC00	CC32	PC
Big Noise Lead	121	36	81
Wide Pulse	121	37	81
Narrow Pulse	121	38	81
Reverse Saw	121	39	81
Trance Unison	121	42	81
Wobbly Razor	121	19	80
Syn Clarinet Lead	121	20	80
Square Pulse	121	21	80
Distort Square	121	22	80
Square Tube 1	121	23	80
Square Tube 2	121	24	80
Mid Square Pulse	121	25	80
Square Tooth	121	26	80
Double Square	121	27	80
Disco Synth Bass	121	21	87
Vintage MG	121	22	87
Formant Fade	121	23	87
PWM Lead 1	121	40	81
PWM Lead 2	121	41	81
Rude Saw EDM	121	43	81
Future Saw Pulse	121	44	81
Rude Octaver Y-	121	45	81
Linked Saw Lead	121	46	81
EDM Scat	121	3	85
Formant Snap	121	4	85
Dist Ghost	121	5	85
Rude Talk	121	6	85
Voice Lead EDM	121	7	85
Ultra Voice EDM	121	8	85
Rom Pluck	121	8	98
Strum Pluck	121	9	98
Triangle Pluck	121	10	98
Triangle Noise	121	11	98
Triangle Electro	121	12	98

Sound	CC00	CC32	PC
Next Dance DNC	121	13	87
Trance Filter	121	16	87
Vintage Monster	121	17	87
JP8	121	6	62
Dance Basic	121	25	81
Spire Synth	121	22	81
EDM Synth	121	24	81
Dubstep Synth	121	14	84
Noised Lead DNC	121	20	87
Deep Mod DNC	121	10	84
Lab Synth DNC	121	8	84
Thin Pul Seq DNC	121	21	81
Synth Whooo	121	16	90
Analog Synth 1	121	17	90
Analog Synth 2	121	18	90
Poly6 + JP8	121	19	90
Summit Pulse	121	13	81
Bros Buzz Y+	121	14	87
Fat Synth	121	15	87
Parallel Trance	121	9	84
Dance Syn Perc	121	3	114
Shape Sound	121	5	114
Fast Glide Saw	121	20	81
Fing Glide Square	121	16	80
Old Portamento	121	3	80
Monster Synth	121	18	87
Side Distortion	121	13	84
Revolution	121	12	84
Square Solo	121	17	80
Triangle Solo	121	26	81
Saw Solo	121	27	81
Square & Pulse	121	18	80
Leadspace	121	23	81
Landscape	121	1	82

Sound	CC00	CC32	PC
Caos Synth	121	15	84
Vocal Brass	121	6	63
Justified	121	11	84
Rave	121	6	97
Rich Lead	121	3	87
16-8-4 & Sub32	121	28	81
Mono Saw Detune	121	17	81
Mono Saw 2 Octave	121	18	81
Mono Saw 3 Octave	121	19	81
Power Saw	121	5	81
Bass Phat Saw	121	12	87
Octo Lead	121	6	81
Dance Lead	121	4	80
Wave Lead	121	5	80
Simple Square	121	14	80
Reverse Pulse	121	14	81
HipHop Lead	121	6	87
Phat Saw Lead	121	8	81
Big Sweep Stab	121	12	90
Noisy Stab	121	8	90
A Leadload	121	11	87
OB Lead	121	10	87
Big & Raw	121	8	87
Synth Pianoid	121	12	81
Polysix	121	15	81
Polysix & Sub	121	16	81
Fat Synth Oct Sub	121	19	87
Metallic Rez	121	4	84
Dance ReMix	121	10	91
Port Whine	121	12	80
Sub Harmonic	121	15	80
Factory/Ethnic			
Bagpipes	121	4	109
Mandolin UpDw Y-	121	52	25

Sound	CC00	CC32	PC
Mandolin DNC	121	40	25
Mandolin UpDw	121	43	25
Mandolin Orch.1	121	41	25
Mandolin Orch.2	121	42	25
Cavaquinho 1	121	27	24
Cavaquinho 2	121	23	24
Cavaquinho 3	121	24	24
Bandolim	121	46	25
Berimbau DNC	121	2	106
Berimbau Rel.DNC	121	1	106
Ukulele 1	121	25	24
Zither	121	9	104
Sitar 1	121	8	104
Sitar 2	121	2	104
Sitar 3	121	4	104
Fiddle	121	1	110
Banjo Thumb DNC	121	6	105
Banjo Fing/ThuDNC	121	7	105
Banjo Key Off	121	1	105
Banjo	121	4	105
Kanoun 1	121	5	107
Kanoun 2	121	2	107
Kanoun Tremolo 1	121	6	107
Kanoun Tremolo 2	121	3	107
Kanoun Mix	121	4	107
Oud 1	121	5	105
Oud 2	121	2	105
Bouzouki	121	5	104
Nay	121	2	72
Kawala	121	1	75
G Clarinet	121	2	71
Klarnet 1	121	11	71
Klarnet 2	121	12	71
Hichiriki	121	2	111

Sound	CC00	CC32	PC
Highland Bagpipes	121	3	109
Uilleann Pipes	121	2	109
Zurna 1	121	3	111
Zurna 2	121	1	111
Gamelan Bells	121	1	112
Garbage Mall	121	3	112
Jaw Harp	121	3	105
Baglama 1	121	7	107
Baglama 2	121	8	107
Baglama 3	121	9	107
Turk Fill Legato	121	4	111
Double Z Legato	121	5	111
Trpt Wave Legato	121	6	111
Syn Zurna Legato	121	7	111
Factory/Bass			
JBass Fing DN1	121	29	33
JBass Fing DN2	121	30	33
JBass Pick DN1	121	18	34
JBass Pick DN2	121	19	34
JBass Slap	121	8	36
SRBass Fing DN1	121	27	33
SRBass Fing DN2	121	28	33
SRBass Pick DN1	121	16	34
SRBass Pick DN2	121	17	34
SRBass Slap	121	9	36
PBass 1 Fing DN1	121	33	33
PBass 1 Fing DN2	121	34	33
FSBass Pick DN1	121	14	34
FSBass Pick DN2	121	15	34
PBass 2 Fing DN1	121	25	33
FretlessBass1 DN1	121	11	35
FretlessBass2 DN1	121	10	35
Fretless Bass 3	121	3	35
Fretless Bass 4	121	1	35

Sound	CC00	CC32	PC
PBass 2 Fing DN2	121	26	33
HBass Fing&Pick1	121	35	33
HBass Fing&Pick2	121	36	33
HBass Pick&Fing1	121	20	34
HBass Pick&Fing2	121	21	34
Woofier Pusher	121	9	35
Acoustic Bass 1	121	13	32
Acoustic Bass 2	121	14	32
Acoustic Bass 3	121	3	32
Acoustic Bass 4	121	9	32
Bass & Ride	121	2	32
Finger Bass DN1	121	16	33
Finger Bass 2	121	7	33
Finger Bass 3	121	4	33
Thumb Bass 1	121	1	37
Thumb Bass 2	121	2	36
Vintage PickBass1	121	12	34
Vintage PickBass2	121	23	33
Vintage PickBass3	121	18	33
Pick Bass	121	2	34
Jazz Pick Bass	121	13	34
SynBass Drone 1	121	25	87
SynBass Drone 2	121	24	87
SynBass Drone 3	121	21	38
SynBass & Kick 1	121	23	39
SynBass & Kick 2	121	24	39
SynBass Wah 1	121	22	38
SynBass Wah 2	121	18	38
SynBass Wah 3	121	5	38
SynBass Wah 4	121	16	39
SynBass Wah 5	121	17	38
SynBass Dark	121	25	39
SynBass Pick	121	26	38
SynBass Glide	121	27	38

Sound	CC00	CC32	PC
SynBass Soft	121	12	35
Trap Bass	121	22	39
Quadra Bass 1 Y-	121	23	38
Quadra Bass 1 AT	121	24	38
Quadra Bass 1-/+Y	121	25	38
SynBass PickDark1	121	21	39
SynBass PickDark2	121	11	38
SynBass Legato	121	20	38
SynBass Saw	121	18	39
SynBass Perc 1	121	19	38
SynBass Perc 2	121	17	39
SynBass Resonance	121	8	38
SynBass Jungle 1	121	13	38
SynBass Jungle 2	121	5	39
SynBass Techno 1	121	6	17
SynBass Techno 2	121	13	17
SynBass Deep	121	14	39
JBass Fing&Slap	121	32	33
SRBass Fing&Slap	121	31	33
DarkSlap Bass DN1	121	7	36
Stein Bass	121	3	34
ChorusFinger Bass	121	8	33
SynBass Fifth	121	20	39
Pulse Bass	121	19	39
SynBass Attack	121	8	39
Factory/SFX			
Stadium	121	6	126
Incipit Noises	121	3	119
White Incipit	121	4	119
Sci-Fi Incipit	121	5	119
Sci-fi Shifter 1	121	6	119
Sci-fi Shifter 2	121	7	119
Atmos Lead	121	10	97
Atom Seq 1	121	11	97

Sound	CC00	CC32	PC
Atom Seq 2	121	12	97
Atom Seq 3	121	13	97
Atom Seq 4	121	14	97
Atom Seq 5	121	15	97
Atom Seq 6	121	16	97
Atmos Melody 1	121	17	97
Atmos Melody 2	121	18	97
Atmos Melody 3	121	19	97
Atmos Melody 4	121	20	97
Atmos Melody 5	121	21	97
Atmos Melody 6	121	22	97
Atmos Melody 7	121	23	97
Atmos Melody 8	121	24	97
Atmos Melody 9	121	25	97
Atmos Melody 10	121	26	97
Atmos Melody 11	121	27	97
Atmos Melody 12	121	28	97
Atmos Melody 13	121	29	97
Atmos Melody 14	121	30	97
Atmos Melody 15	121	31	97
Atmos Melody 16	121	32	97
Atmos Melody 17	121	33	97
Atmos Melody 18	121	34	97
Atoms Impact 1	121	4	103
Atoms Impact 2	121	5	103
Atoms Sci-fi	121	6	103
Sci-fi Shifter 3	121	7	103
Bang Industry 1	121	6	114
Bang Industry 2	121	7	114
Bang Metal	121	8	114
Noise Impact 1	121	9	122
Noise Impact 2	121	10	122
Digi Boiling 1	121	11	122

Sound	CC00	CC32	PC
Digi Boiling 2	121	12	122
Cave Window	121	13	122
Brain Core	121	15	125
Lava Gruncy	121	14	125
Flying Saucer	121	12	126
Darka	121	13	126
Cinematic Impact1	121	5	127
Cinematic Impact2	121	6	127
Cinematic Impact3	121	7	127
Cinematic Impact4	121	8	127
Cinematic Impact5	121	9	127
Cinematic Impact6	121	10	127
Cinematic Impact7	121	11	127
Cinematic Bang 1	121	12	127
Cinematic Bang 2	121	13	127
Cinematic Bang 3	121	14	127
Cinematic Bang 4	121	15	127
Cinematic Bang 5	121	16	127
Cinematic Bang 6	121	17	127
Cinematic Bang 7	121	18	127
Cinematic Bang 8	121	19	127
Motor World	121	13	125
Giungle Set	121	6	122
Water Set	121	7	122
Weather Set	121	8	122
Clock Set	121	6	124
Reverse Atk Set	121	7	124
Video-Game Set	121	10	125
Cartoon Set	121	11	125
Invader Set	121	12	125
Siren Set	121	16	125
Life Set	121	8	126
Horror Set	121	9	126

Sound	CC00	CC32	PC
Quiz Show Set	121	10	126
Talk Show Set	121	11	126
SFX Catalog 1	121	17	125
SFX Catalog 2	121	18	125
SFX Catalog 3	121	19	125
SFX Catalog 4	121	20	125
SFX Catalog 5	121	21	125
SFX Cinematic	121	22	125
SFX Industry	121	23	125
SFX Life	121	24	125
SFX Melody&Athmos	121	25	125
SFX TV & Show	121	26	125
Legacy/Piano			
Piano Pad 1	121	2	1
Piano Pad 2	121	3	1
90's Piano	121	3	2
2000's Piano	121	4	2
Chorus Piano	121	5	2
E. Grand Phaser	121	10	2
Saloon Piano 2	121	4	3
Harpsichord 3	121	6	6
Harpsi 16'	121	5	6
Harpsi Korg	121	4	6
Clav Snap	121	3	7
Sticky Clav	121	4	7
Clav	121	5	7
Clav Wah	121	2	7
Synth Clav	121	6	7
Legacy/Electric Piano			
Pro Dyno EP	121	5	4
Pro Stage EP	121	6	4
Studio EP	121	7	4
Suit Case88 EP2	121	33	4

Sound	CC00	CC32	PC
Dyno Tine EP 1	121	10	4
Tine E. Piano 2	121	19	4
Dyno Tine EP 2	121	22	4
Bell E. Piano 1	121	23	4
Bell E. Piano 2	121	24	4
EP+Damper	121	26	4
Vintage EP	121	4	4
Stereo Dig. EP	121	6	5
FM Stack EP	121	16	5
Hybrid EP	121	8	5
Phantom Tine	121	10	5
Soft Wurly	121	13	4
Hard Wurly	121	14	4
Velo Wurly	121	15	4
White Pad EP	121	13	5
FM Pad EP	121	15	5
Sweeping EP	121	12	5
Classic Dig. EP	121	7	5
Syn Piano X	121	5	5
Road Piano	121	11	2
Legacy/Mallet & Bell			
Vibraphone 2	121	3	11
Monkey Skuls	121	3	12
Digi Bell	121	4	98
Krystal Bell	121	3	98
Legacy/Accordion			
Sweet Harmonica	121	1	22
Akordeon	121	2	21
Acc. Clarinet NT	121	20	21
Acc. Piccolo NT	121	22	21
Detune Accordion	121	15	21
Sweet Musette	121	11	21
Musette 1	121	3	21

Sound	CC00	CC32	PC
Musette 2	121	4	21
Cassotto	121	9	21
Cassotto 16' DNC	121	30	21
Cassotto Or.Tune	121	13	21
Cassotto NorTune	121	14	21
Musette Clar.	121	5	21
Arabic Accordion	121	10	21
Master Acc 2	121	23	21
Steirische Acc 4	121	28	21
Harmonica	121	2	22
Harmonica AT 1	121	3	22
Harmonica AT 2	121	4	22
Harmonica 1 DNC	121	5	22
Jazz Harm. DNC	121	6	22
Sweet Harm. DNC	121	7	22
Melodica DNC	121	8	22
Harmonica 2 DNC	121	9	22
Harmonica 3 DNC	121	10	22
Accordion16,8,4'	121	3	23
Steirische Acc 3	121	27	21
Acc.Voice Change	121	6	23
Legacy/Organ			
Classic Click	121	4	18
Perc. Organ 3	121	10	17
Perc.Short Deca	121	8	18
Rock Organ 2	121	11	18
Jimmy Organ V.	121	10	18
BX3 Rock 1 V.	121	10	16
BX3 Rock 2 V.	121	1	18
BX3 Rock 3 V.	121	5	18
BX3 Rock 4 V.	121	12	18
Dirty B	121	3	18
Killer B	121	2	18
BX3 Short Decay	121	7	17

Sound	CC00	CC32	PC
Super BX Perc.	121	6	18
Gospel Organ 2	121	9	16
Gospel Organ V.	121	13	16
BX3 Gospel V.	121	21	16
Drawbars Organ	121	14	16
Organ Mid V.	121	16	16
Organ Hi V.	121	17	16
Drawbars Fast V.	121	18	16
Drawbars Slow V.	121	19	16
Organ Low+1'V.	121	33	16
Organ HiMix1 V.	121	34	16
Organ HiMix2 V.	121	35	16
Organ 16+51/3 V.	121	36	16
Organ Low 2 V.	121	4	16
Old Wheels	121	3	17
Dark Organ 1	121	7	16
Dark Organ 2	121	5	16
Rotary Organ	121	8	17
M1 Organ	121	5	17
Dirty JazzOrgan	121	7	18
Arabian Organ	121	12	16
Theatre Organ 3	121	24	16
Theatre Organ 4	121	25	16
Tibia	121	26	16
Tibia 16+8+4'	121	27	16
Tibia & Vox	121	28	16
Post Horn Trem.	121	29	16
Tibia & Kinura	121	31	16
Tibia Vox Glock	121	32	16
Pipe Tutti 1	121	6	19
Pipe Tutti 2	121	8	19
Pipe Tutti 3	121	9	19
Pipe Tutti 4	121	10	19
Church Pipes	121	4	19

Sound	CC00	CC32	PC
Full Pipes	121	5	19
Flauto Pipes	121	3	20
Pipe Mixture	121	3	19
Pipe Flute 1	121	4	20
Pipe Flute 2	121	5	20
Small Pipe	121	2	20
Positive Organ	121	7	19
Organ Pedal	121	11	32
Legacy/Guitar			
Nylon Bossa	121	4	24
Nylon Vel. Harm.	121	10	24
Nylon Guitar	121	15	24
Brazilian Guitar	121	9	24
Real Steel Gtr	121	31	25
Steel Folk Gtr	121	9	25
Guitar & Strings	121	7	24
Finger Key Off	121	7	25
Club Jazz Gtr 2	121	3	26
Pop Steel Slide	121	23	25
Finger Tips	121	8	25
Country Nu	121	11	27
Reso Guitar	121	12	25
Tel. Middle	121	26	27
Clean Mute Gtr	121	6	28
Clean Funk	121	8	28
Hackbrett	121	6	25
Tel. Bridge	121	27	27
Guitarish	121	8	27
Stra. Gtr Slide	121	17	27
Stra. Chime	121	5	28
L&R E.Guitar 2	121	10	27
Rhythm E.Guitar	121	7	28
Muted Guitar	121	19	28
E.Gtr Harmonics	121	2	31

Sound	CC00	CC32	PC
Solo Dist.Guitar	121	7	30
Dist. Steel Gtr	121	12	30
Joystick Gtr Y-	121	3	30
Ac.Guitar KeyOff	121	5	24
Nylon Gtr Pro1	121	8	24
Nylon Gtr Pro2	121	11	24
Nylon Gtr RX1	121	12	24
Nylon Gtr RX2	121	13	24
Nylon Slide Pro	121	14	24
RealNylon Gtr ST	121	16	24
Real Nylon Gtr	121	17	24
Natural Nylon	121	19	24
Concert Gtr Pro	121	21	24
Steel Guitar 1	121	4	25
Steel Guitar 2	121	20	25
Steel 12 Strings	121	5	25
12 Strings Pro	121	17	25
Steel Slide Pro1	121	13	25
Steel Slide Pro2	121	14	25
Steel Guitar RX1	121	15	25
Steel Guitar RX2	121	16	25
12 Strings RX	121	18	25
Concert 12 Str	121	22	24
Pop Steel Gtr 1	121	21	25
Pop Steel Gtr 2	121	22	25
Pop SteelGtr RX1	121	24	25
Pop SteelGtr RX2	121	25	25
RealSteel Gtr ST	121	28	25
RealFolk GtrST 1	121	29	25
RealFolk GtrST 2	121	30	25
Real Folk Gtr	121	32	25
Steel Gtr RX	121	35	25
Classic12Str Pro	121	37	25
Classic12Str DNC	121	38	25

Sound	CC00	CC32	PC
Classic2Strings	121	39	25
Steel Gtr DNC	121	44	25
Pedal Steel	121	4	26
JazzGtr SlidePro	121	6	26
Jazz Gtr 2 DNC	121	7	26
Club Jazz Gtr 1	121	2	26
Soft Jazz Guitar	121	5	26
Clean Jazz 2	121	22	27
Single Coil	121	6	27
New Stra.Guitar	121	7	27
L&R E.Guitar 1	121	9	27
Vox Wah Chick	121	3	120
Funky Wah RX	121	12	27
Clean Guitar 1	121	20	27
Clean Guitar 2	121	25	27
Clean Gtr Pro 1	121	13	27
Clean Gtr Pro 2	121	15	27
Clean Guitar RX1	121	14	28
Clean Guitar RX2	121	15	28
Clean Guitar RX3	121	16	28
Clean Guitar RX4	121	17	28
Clean Guitar RX5	121	18	28
Clean Guitar RX6	121	20	28
Stra. Vel. Pro	121	16	27
Vintage S. 1	121	19	27
Vintage S. 2	121	4	27
Solid Guitar	121	21	27
'54 E. Guitar	121	24	27
Real El. Guitar1	121	30	27
Real El. Guitar2	121	31	27
Real El. Gtr ST1	121	28	27
Real El. Gtr ST2	121	29	27
Chorus Gtr DNC	121	34	27
Stra. Gtr DNC	121	32	27

Sound	CC00	CC32	PC
R&R Guitar	121	4	28
Processed E.Gtr	121	5	27
Clean Funk RX1	121	10	28
Clean Funk RX2	121	36	27
5th Mute Gtr	121	21	28
E.Gtr Amp DNC	121	37	27
Clean Funk RX3	121	11	28
Funk Stein RX1	121	12	28
Funk Stein RX2	121	13	28
Soft Overdrive	121	2	29
Lead Guitar DNC	121	4	29
Dist. Guitar RX1	121	9	30
Dist. Guitar RX2	121	10	30
Dist. Guitar	121	11	30
Dist. Gtr 3 DNC	121	13	30
Wet Dist. Guitar	121	6	30
Disto Mute	121	9	28
Mute Monster	121	5	30
Power Chords 2	121	4	30
Legacy/Strings & Vocal			
Violin Expr. 1	121	8	40
Violin Expr. 2	121	2	40
Violin Expr. 3	121	4	40
Slow Violin	121	3	40
Violin Expr. DNC	121	5	40
Conc.Violin DNC	121	6	40
Real Violin DNC	121	7	40
Violin DNC	121	9	40
Violin & Viola	121	2	41
Cello	121	1	42
Class.Contrabs	121	1	43
Strings Ens. 1	121	21	48
Strings Ens. 2	121	3	49
Movie Str.1 DNC	121	7	49

Sound	CC00	CC32	PC
Movie Str.2 DNC	121	8	49
ConcertStrings 2	121	23	48
Real Strings 1	121	9	49
Real Strings 2	121	10	49
Movie Strings 3	121	5	49
Movie Strings 4	121	6	49
i3 Strings	121	5	48
Full Strings	121	2	49
Spiccato Strings2	121	4	49
ConcertStrings 1	121	11	49
StrappatoStrings	121	12	49
Symphonic Bows	121	10	48
Ensemble & Solo	121	11	48
Tremolo Strings 2	121	1	44
Pizz. Ensemble	121	1	45
Strings Ens. 3	121	22	48
Stereo Strings	121	3	48
Double Strings	121	3	45
Legato Strings	121	4	48
N Strings	121	6	48
Arco Strings	121	7	48
Octave Strings	121	8	48
Arabic Strings	121	13	48
Strings Quartet	121	9	48
Chamber Strings	121	12	48
OrchestraTutti 2	121	19	48
Strings Choir	121	13	52
Dream Voice	121	5	54
Classic Vox	121	4	54
Doolally	121	2	53
Ooh Voices 2	121	2	52
Take Voices 1	121	4	52
Wuuh Choir	121	8	52
Vocalesque	121	2	54

Sound	CC00	CC32	PC
Grand Choir	121	11	52
Femal Scat	121	15	52
Male Scat	121	16	52
Cycle Scat 2	121	22	52
Scat V.& Bass 2	121	18	52
Scat Voices	121	19	52
Scat Voices DNC	121	20	52
Soprano Vox 4 DNC	121	5	53
SopranoChoirDNC	121	6	53
Orchestra & Oboe2	121	17	48
Master Pad	121	2	89
Take Voices 2	121	5	52
Aah Choir	121	7	52
Choir Light	121	12	52
Slow Choir	121	10	52
Cyber Choir	121	2	85
Ether Voices	121	1	85
Odissey	121	4	50
Sweeper Strings	121	1	49
Analog Strings	121	2	50
Synth Strings 3	121	1	51
Analog Velve	121	3	50
Legacy/Trumpet & Trombone			
Mono Trumpet	121	3	56
Warm Flugel	121	8	56
Pitch Trombone	121	5	57
Soft Trombone	121	4	57
Trombone 1	121	12	57
BeBop Cornet	121	9	56
Flugel Horn	121	7	56
Dynabone	121	3	58
Ob.Tuba&E.Bass 1	121	4	58
Ob.Tuba&E.Bass 2	121	5	58
Dual Trumpets	121	6	56

Sound	CC00	CC32	PC
Trumpet Pro 1	121	10	56
Trumpet Pro 2	121	11	56
Trumpet Overb.	121	2	56
Flugel Horn Pro	121	13	56
Trumpet	121	14	56
Trumpet Expr.1	121	15	56
Trumpet Expr.2	121	4	56
TrumpetShake Y+	121	18	56
Trumpet Pro 3	121	16	56
Trumpet Pitch	121	5	56
Alp Trumpet	121	17	56
Concert Trp. Pro	121	20	56
Cornet Expr.	121	21	56
Cornet Pro 1	121	22	56
Cornet Pro 2	121	23	56
Cornet Legato	121	31	56
JazzTrumpet1 DNC	121	24	56
JazzTrumpet4 DNC	121	30	56
JazzTrumpet5 DNC	121	35	56
JazzCornet 1 DNC	121	25	56
Trumpet Expr.DNC	121	26	56
JazzTrumpet2 DNC	121	27	56
JazzTrumpet3 DNC	121	28	56
JazzCornet 2 DNC	121	29	56
Hard Trombone	121	3	57
HardTrombone DNC	121	19	57
Trombone Expr. 1	121	6	57
Trombone Expr. 2	121	7	57
Trombone Vel. 1	121	8	57
Trombone Vel. 2	121	9	57
Trombone Vel. 3	121	10	57
Trombone Pro Vel	121	11	57
Trombone DNC	121	13	57
Jazz Trb. 2 DNC	121	14	57

Sound	CC00	CC32	PC
Jazz Trb. 1 DNC	121	15	57
Soft Trb. DNC	121	16	57
Trb. Expr. DNC	121	17	57
Jazz Trb. 3 DNC	121	18	57
Legacy/Brass			
Attack Brass	121	8	61
Big BandShake Y+	121	33	61
Trumpet Ens1 Y+	121	35	61
Trumpet Ens2 Y+	121	36	61
Dyna Brass 1	121	14	61
Dyna Brass 2	121	22	61
Double Brass	121	24	61
Power Brass	121	21	61
Film Brass	121	17	61
Glenn & Boys	121	6	61
Brass Slow	121	18	61
Fanfare	121	19	61
Synth Brass 2	121	5	63
Brass Pad	121	3	63
Netherland Hit	121	8	55
Brass Impact	121	4	55
Classic Horns	121	3	60
Horns & Ensemble	121	4	60
Brass & Sax	121	16	61
Trpts & Brass	121	7	61
Soft Horns 2	121	7	60
Soft Horns 3	121	6	60
Trumpet Ens.	121	9	61
Trombones	121	11	61
Sax & Brass	121	5	61
Tight Brass 4	121	12	61
Fat Brass	121	13	61
Brass Hit	121	25	61
Brass Fall	121	26	61

Sound	CC00	CC32	PC
Sforzato Brass	121	23	61
Tight Brass Pro	121	28	61
Brass Section	121	31	61
MorphAttackBrass	121	37	61
Legacy/Sax			
Folk Sax	121	5	66
Breathy Baritone	121	2	67
Breathy Alto 1	121	1	65
Breathy Tenor	121	3	66
Breathy Alto 2	121	3	65
Alto Sax Growl	121	4	65
Soft Tenor	121	2	66
Tenor Growl	121	4	66
Sweet Soprano 3	121	1	64
Soprano Pro	121	2	64
Sweet Soprano 1	121	3	64
Sweet Soprano 2	121	4	64
Soprano Sax DNC	121	5	64
Sax Ensemble 2	121	2	65
Sweet Alto Sax 1	121	5	65
Sweet Alto Sax 2	121	6	65
Soft Alto Sax	121	7	65
Alto Sax Pro	121	8	65
Alto Sax Expr.	121	9	65
Classic Alto Sax	121	10	65
Alto Sax 8 DNC	121	12	65
Jazz Sax 1 DNC	121	13	65
Jazz Sax 2 DNC	121	14	65
Real Sax Ens.	121	15	65
Jazz Sax 3 DNC	121	16	65
Alto Sax 7 DNC	121	17	65
SoftLatinSax DNC	121	18	65
Tenor Sax Noise1	121	1	66
Tenor Sax Noise2	121	6	66

Sound	CC00	CC32	PC
Tenor Sax Expr.1	121	7	66
Tenor Sax Expr.2	121	8	66
Jazz Tenor Sax 1	121	9	66
Jazz Tenor Sax 2	121	10	66
Reed of Power	121	11	66
Tenor Sax 8 DNC	121	12	66
Tenor Sax 2 DNC	121	13	66
Tenor Sax 7 DNC	121	14	66
Tenor Sax 6 DNC	121	15	66
Baritone Growl	121	1	67
Baritone Sax Pro	121	3	67
Baritone Sax	121	4	67
Baritone Sax DNC	121	5	67
Sax Breath & Key	121	2	121
Legacy/Woodwind			
Folk Clarinet	121	7	71
Flute	121	9	73
Wooden Flute	121	7	73
Bambu Flute	121	8	73
English Horn	121	1	69
Recorder 2	121	1	74
Recorder 3	121	2	74
Classic Oboe	121	2	68
Oboe 4	121	4	68
Jazz Clarinet	121	1	71
Section Winds 1	121	3	71
Section Winds 2	121	4	71
Clarinet Ens.	121	5	71
Woodwinds	121	6	71
Clarinet Pro 1	121	8	71
Clarinet Pro 2	121	9	71
Clarinet 3 DNC	121	13	71
RealClarinet DNC	121	14	71
JazzClarinet DNC	121	15	71

Sound	CC00	CC32	PC
SoloClarinet DNC	121	16	71
Clarinet 4 DNC	121	19	71
Clarinet 5 DNC	121	20	71
Jazz Flute Expr.	121	1	73
Flute Switch	121	2	73
Flute Dyn. 5th	121	3	73
Flute Frullato	121	4	73
Orchestra Flute	121	5	73
Jazz Flute	121	10	73
Flute DNC	121	11	73
Orch. Flute DNC	121	12	73
Jazz Flute 1 DNC	121	13	73
Jazz Flute 2 DNC	121	14	73
Pan Flute 1 DNC	121	2	75
Pan Flute 2 DNC	121	3	75
Pan Flute Y-	121	4	75
Old Shakuhachi	121	1	77
Whistle Sine	121	1	78
Breathy Whistle	121	2	78
Whistle 5	121	3	78
Whistle 4	121	4	78
Whistle 3 DNC	121	5	78
Legacy/Synth Pad			
Sky Watcher	121	2	90
Vintage Pad	121	11	89
You Decide	121	8	95
Korgmatose	121	13	90
Reoccurring Astra	121	6	95
Astral Dream	121	1	95
Reso Down	121	2	97
Crimson 5ths	121	1	86
Freedom Pad	121	7	89
Noble Pad	121	5	97
Mellow Pad	121	4	95

Sound	CC00	CC32	PC
Lonely Spin	121	1	100
Synth Ghostly	121	2	100
Farluce	121	11	90
Bell Choir	121	7	98
Elastick Pad	121	7	97
Caribbean	121	2	96
VCF Modulation	121	3	101
Chiff Touch Pad	121	1	83
Virtual Traveler	121	1	88
Tinklin Pad	121	3	97
OB Pad	121	12	89
Dark Element	121	3	95
Money Pad	121	5	89
Analog Pad 2	121	9	89
Analog Pad 3	121	10	89
Dark Anna	121	13	89
Cross Sweep	121	6	90
Tsunami Wave	121	6	91
Ravelian Pad	121	8	91
Pop Synth Pad 2	121	12	91
Techno Stab DNC	121	3	93
Double Sweep	121	9	95
Motion Ocean	121	1	96
Wave Cycle	121	3	96
Pods In Pad	121	4	97
Moving Bell	121	5	98
Bengione	121	1	99
Dreaming Coil	121	3	99
Movie Stack 4	121	7	99
Rhythmical Synth	121	9	99
Wide Attack	121	10	99
Organ Stab DNC	121	4	101
Legacy/Synth Lead			
Motion Raver	121	1	101

Sound	CC00	CC32	PC
Synchro City	121	2	84
Wild Arp	121	6	55
Seq Lead	121	7	81
Old & Analog	121	8	80
Flip Blip	121	7	55
Reso Sweep	121	1	90
Synth Sweeper	121	3	90
Sync Kron	121	3	84
Tecno Phonic	121	10	90
Band Passed	121	3	102
Cat Lead	121	9	87
Pan Reso	121	4	102
Square Rez	121	11	80
Rezbo	121	11	81
Auto Pilot 1	121	14	38
Square Bass	121	7	87
Brian Sync	121	5	84
Arp Twins	121	6	84
LoFi Ethnic	121	7	84
Sine Wave	121	6	80
Analog Lead	121	7	80
Gliding Square	121	9	80
Sine Switch	121	10	80
2VCO Planet Lead	121	13	80
Glide Lead	121	9	81
Fire Wave	121	10	81
Electro Lead	121	2	87
Thin Analog Lead	121	4	87
Express. Lead	121	5	87
Arp Angeles	121	2	88
Power Synth	121	3	89
Digital PolySix	121	7	90
Mega Synth	121	9	90
Cycle Seq. 1	121	8	96

Sound	CC00	CC32	PC
Cycle Seq. 2	121	9	96
Legacy/Ethnic			
Mandolin Key Off	121	10	25
War Pipes	121	1	109
Classic Sitar	121	7	104
Hit in India	121	5	55
Tambra	121	6	104
Indian Stars	121	3	104
Bali Gamelan	121	2	112
Ukulele Gtr	121	26	24
Mandolin Trem.	121	11	25
Mandolin Ens. 1	121	26	25
Mandolin Ens. 2	121	27	25
Legacy/Bass			
Ac. Bass Buzz	121	1	32
Slap Bass 1	121	6	36
Slap Bass 2	121	6	37
Slap Bass 3	121	7	37
DynaSlapBass RX	121	3	37
Chorus Slap Bass	121	4	37
DarkWoody A.Bass	121	5	32
More Mid Bass	121	11	33
Woofer Pusher 2	121	6	35
Dark R&B Bass1	121	4	35
Dyna Bass	121	2	37
Ticktacing Bass	121	9	34
Stick Bass	121	5	33
Dark R&B Bass2	121	5	35
Auto Pilot 2	121	13	39
Dr. Octave	121	16	38
Monofilter Bass	121	11	39
Synth Bass 80ish	121	9	39
Reso Bass	121	12	39
Autofilter Bass	121	10	39

Sound	CC00	CC32	PC
Nasty Bass	121	6	39
30303 Square	121	6	38
Bass Square	121	7	38
Phat Bass	121	7	39
Blind As A Bat	121	12	38
Acous. Bass RX	121	7	32
Acoustic Bass 5	121	8	32
Real Ac. Bass	121	12	32
Acous. Bass Pro	121	4	32
Bass & Ride 2	121	6	32
Organ Bass	121	10	32
Finger E. Bass 7	121	2	33
Finger E. Bass 4	121	3	33
Finger E. Bass 5	121	6	33
Bright Finger B.	121	9	33
Finger E. Bass 1 RX	121	10	33
Finger Slap	121	12	33
Finger E. Bass 2 RX	121	13	33
Finger E. Bass 6	121	15	33
Vintage P. Round	121	17	33
5 Strings Bass RX	121	19	33
Dark E. Bass 1	121	20	33
Dark E. Bass 2	121	24	33
Finger E. Bass 3 RX	121	21	33
Dark E. Bass DNC	121	22	33
Bass & Guitar	121	4	34
Finger B. & Guitar	121	14	33
Bass & Gtr Double	121	6	34
Bass Mute	121	5	34
Picked E. Bass 2	121	1	34
Picked E. Bass 3	121	11	34
Picked E. Bass 4	121	7	34
Picked E. Bass 5	121	8	34
Picked E. Bass RX	121	10	34

Sound	CC00	CC32	PC
Fretless Bass 5	121	2	35
Fretless Bass 6	121	7	35
MM Fretless DNC	121	8	35
Super Bass 2	121	1	36
FunkSlapBass RX	121	3	36
SlapFingerBassRX	121	4	36
SlapPickedBassRX	121	5	36
The Other Slap	121	5	37
Digi Bass 2	121	10	38
Digi Bass 1	121	9	38
Hybrid Bass	121	15	38
Euro Bass	121	4	39
Synth Bass 2	121	15	39
GM/XG/Piano			
AcousticPiano GM	121	0	0
Ac. Piano Wide	121	1	0
Ac. Piano Dark	121	2	0
Bright Piano GM	121	0	1
Bright PianoWide	121	1	1
E. Grand Piano GM	121	0	2
E. Grand Wide	121	1	2
Honky-Tonk GM	121	0	3
Honky Wide	121	1	3
E. Piano 1 GM	121	0	4
Detuned EP 1	121	1	4
EP 1 Veloc. Mix	121	2	4
60's E. Piano	121	3	4
E. Piano 2 GM	121	0	5
Detuned EP 2	121	1	5
EP 2 Veloc. Mix	121	2	5
EP Legend	121	3	5
EP Phase	121	4	5
Harpsichord GM	121	0	6
Harpsi OctaveMix	121	1	6

Sound	CC00	CC32	PC
Harpsi Wide	121	2	6
Harpsi Key Off	121	3	6
Clav GM	121	0	7
Pulse Clav	121	1	7
AcousticPiano XG	0	0	0
AcousticPiano KP	0	1	0
Mellow Gr. Piano	0	18	0
Piano Strings	0	40	0
Piano Dream	0	41	0
Bright Piano XG	0	0	1
Bright Piano KP	0	1	1
E.Grand Piano XG	0	0	2
E.Grand Piano KP	0	1	2
E. Grand Detuned	0	32	2
Layered E.Grand1	0	40	2
Layered E.Grand2	0	41	2
Honky-Tonk XG	0	0	3
Honky-Tonk KP	0	1	3
E. Piano 1 XG	0	0	4
E. Piano 1 KP	0	1	4
Mellow EP1	0	18	4
Chorus EP 1	0	32	4
Hard El. Piano	0	40	4
Vel. X-Fade EP 1	0	45	4
60's El. Piano 1	0	64	4
E. Piano 2 XG	0	0	5
E. Piano 2 KP	0	1	5
Chorus EP 2	0	32	5
FM EP Hard	0	33	5
FM Legend EP	0	34	5
FM Phase EP	0	40	5
Dx & Analog	0	41	5
FM Koto EP	0	42	5
Vel. X-Fade EP 2	0	45	5

Sound	CC00	CC32	PC
Harpsichord XG	0	0	6
Harpsichord KP	0	1	6
Harpsichord HP	0	25	6
Harpsi Octave	0	35	6
Clav XG	0	0	7
Clav KP	0	1	7
Clav. Wah Dyn.	0	27	7
Pulse Clav X	0	64	7
Pierce Clav	0	65	7
GM/XG/Chromatic Percuss			
Celesta GM	121	0	8
Glockenspiel GM	121	0	9
Music Box GM	121	0	10
Vibraphone GM	121	0	11
Vibraphone Wide	121	1	11
Marimba GM	121	0	12
Marimba Wide	121	1	12
Xylophone GM	121	0	13
Tubular Bell GM	121	0	14
Church Bell	121	1	14
Carillon	121	2	14
Dulcimer GM	121	0	15
Celesta XG	0	0	8
Glockenspiel XG	0	0	9
Music Box XG	0	0	10
Orgel Bell	0	64	10
Vibraphone XG	0	0	11
Vibraphone KP	0	1	11
Hard Vibraphone	0	45	11
Marimba XG	0	0	12
Marimba KP	0	1	12
Sin Marimba	0	64	12
Balimba	0	97	12
Log Drum X	0	98	12

Sound	CC00	CC32	PC
Xylophone XG	0	0	13
Tubular Bell XG	0	0	14
Church Bells	0	96	14
Carillonx	0	97	14
Dulcimer XG	0	0	15
Dulcimer Octave	0	35	15
Cimbalom	0	96	15
Santur 2	0	97	15
GM/XG/Organ			
Drawbar Org GM	121	0	16
Det. Drawbar Org	121	1	16
It. 60's Organ	121	2	16
Drawbar Org. 2	121	3	16
Perc.Organ GM	121	0	17
Det. Perc. Organ	121	1	17
Perc.Organ 2	121	2	17
Rock Organ GM	121	0	18
Church Organ GM	121	0	19
Church Oct. Mix	121	1	19
Detuned Church	121	2	19
Reed Organ GM	121	0	20
Puff Organ	121	1	20
Accordion GM	121	0	21
Accordion 2	121	1	21
Harmonica GM	121	0	22
Tango Accord.GM	121	0	23
Drawbar Org XG	0	0	16
Detuned Drawbar	0	32	16
60's Draw.Org. 1	0	33	16
60's Organ X	0	34	16
70's DB Org. 1	0	35	16
Drawbar Org. 3	0	36	16
Drawbar 5th	0	37	16
Even Bar Org.	0	38	16

Sound	CC00	CC32	PC
Organ 16+2'2/3	0	40	16
Organ Bass Dance	0	64	16
70's DB Org. 2	0	65	16
Cheezy Organ	0	66	16
Drawbar Org Perc	0	67	16
Perc.Organ XG	0	0	17
70's Perc. Organ	0	24	17
ChorusPerc.Organ	0	32	17
Lite Organ	0	33	17
Percussive Org X	0	37	17
Rock Organ XG	0	0	18
Rotary Organ V.	0	64	18
Slow Rotary	0	65	18
Fast Rotary	0	66	18
Church Organ XG	0	0	19
Church Organ 3	0	32	19
Church Organ 2	0	35	19
Notre Dame	0	40	19
Organ Flute	0	64	19
Trem. Org. Flute	0	65	19
Reed Organ XG	0	0	20
Puff Organx	0	40	20
Accordion XG	0	0	21
Accord. It.	0	32	21
Harmonica XG	0	0	22
Soft Harmonica	0	32	22
Tango Accord.XG	0	0	23
Tango Accord.2	0	64	23
GM/XG/Guitar			
Nylon Guitar GM	121	0	24
Ukulele 2	121	1	24
Nylon Key Off	121	2	24
Nylon Guitar 2	121	3	24
Steel Guitar GM	121	0	25

Sound	CC00	CC32	PC
12 Strings Gtr	121	1	25
Mandolin	121	2	25
Steel Gtr & Body	121	3	25
Jazz Guitar GM	121	0	26
Pedal Steel Gtr	121	1	26
Clean Guitar GM	121	0	27
Det.Clean El.Gtr	121	1	27
Mid Tone Gtr	121	2	27
Muted Guitar GM	121	0	28
Funky Cut El.Gtr	121	1	28
Mute Vel. El.Gtr	121	2	28
Jazz Man	121	3	28
Overdrive Gtr GM	121	0	29
Guitar Pinch	121	1	29
DistortionGtr GM	121	0	30
Feedback DistGtr	121	1	30
Dist. Rhythm Gtr	121	2	30
Gtr Harmonic GM	121	0	31
Guitar Feedback	121	1	31
Nylon Guitar XG	0	0	24
Nylon Guitar 2X	0	16	24
Nylon Guitar 3X	0	25	24
Nylon & Harm. V.	0	43	24
Ukulele X	0	96	24
Steel Guitar XG	0	0	25
Steel Guitar X	0	16	25
12 Strings Gtr X	0	35	25
Nylon plus Steel	0	40	25
SteelGtrWithBody	0	41	25
Mandolin X	0	96	25
Jazz Guitar XG	0	0	26
Mellow Guitar	0	18	26
Jazz Man Amp	0	32	26
Clean Guitar XG	0	0	27

Sound	CC00	CC32	PC
Chorus El.Gtr	0	32	27
Muted Guitar XG	0	0	28
Funk Cut Guitar	0	40	28
Muted Steel Gtr	0	41	28
Funk Guitar	0	43	28
Jazz Boy	0	45	28
Overdrive Gtr XG	0	0	29
Guitar Nip	0	43	29
DistortionGtr XG	0	0	30
Feedback DistGt1	0	40	30
Feedback DistGt2	0	41	30
Gtr Harmonic XG	0	0	31
Gtr Feedback	0	65	31
Gtr Harmonic	0	66	31
GM/XG/Bass			
Acoustic Bass GM	121	0	32
Finger Bass GM	121	0	33
Finger Slap Bass	121	1	33
Picked E.Bass GM	121	0	34
Fretless Bass GM	121	0	35
Slap Bass 1 GM	121	0	36
Slap Bass 2 GM	121	0	37
Synth Bass 1 GM	121	0	38
Synth Bass Warm	121	1	38
Synth Bass Reso	121	2	38
Clavi Bass	121	3	38
Hammer	121	4	38
Synth Bass 2 GM	121	0	39
SynthBass Attack	121	1	39
SynthBass Rubber	121	2	39
Attack Pulse	121	3	39
Acoustic Bass XG	0	0	32
Jazz Rhythm	0	40	32
Ac. Bass V.	0	45	32

Sound	CC00	CC32	PC
Finger Bass XG	0	0	33
Finger Dark	0	18	33
Flange Bass	0	27	33
FngBass&DstGuit.	0	40	33
FingerSlapBass V	0	43	33
Finger Bass X	0	45	33
Modulated Bass	0	65	33
Picked E. Bass XG	0	0	34
Muted Pick Bass	0	28	34
Fretless Bass XG	0	0	35
Fretless Bass B	0	32	35
Fretless Det.	0	33	35
Fretless Soft	0	34	35
Synth Fretless	0	96	35
Smooth Fretless	0	97	35
Slap Bass 1 XG	0	0	36
Resonant Slap	0	27	36
Punch Thumb Bass	0	32	36
Slap Bass 2 XG	0	0	37
Velo. Sw. Slap	0	43	37
Synth Bass 1 XG	0	0	38
Syn. Bass Dark	0	18	38
Fast Reso. Bass	0	20	38
Acid Bass	0	24	38
Clav. Bass	0	35	38
Techno Bass	0	40	38
Orbiter Bass	0	64	38
Xsquare Bass	0	65	38
Rubber Bass	0	66	38
Hammer Bass	0	96	38
Synth Bass 2 XG	0	0	39
Mellow Syn Bass	0	6	39
Sequenced Bass	0	12	39
Click Synth Bass	0	18	39

Sound	CC00	CC32	PC
Synth Bass Dark	0	19	39
Smooth Syn. Bass	0	32	39
Modular Syn Bass	0	40	39
DX Bass	0	41	39
X Wire Bass	0	64	39
GM/XG/Strings			
Violin GM	121	0	40
Slow Att. Violin	121	1	40
Viola GM	121	0	41
Cello GM	121	0	42
Contrabass GM	121	0	43
Tremolo Str. GM	121	0	44
Pizzicato Str. GM	121	0	45
Harp GM	121	0	46
Yang Chin	121	1	46
Timpani GM	121	0	47
Violin XG	0	0	40
Slow Atk Violin	0	8	40
Viola XG	0	0	41
Cello XG	0	0	42
Contrabass XG	0	0	43
Tremolo Str. XG	0	0	44
Slw Tremolo Str.	0	8	44
Suspense Strings	0	40	44
Pizzicato Str. XG	0	0	45
Harp XG	0	0	46
Yang Chin X	0	40	46
Timpani XG	0	0	47
GM/XG/Ensemble			
Strings Ens.1 GM	121	0	48
Strings & Brass	121	1	48
60's Strings	121	2	48
Strings Ens.2 GM	121	0	49
Synth Strings1GM	121	0	50

Sound	CC00	CC32	PC
Synth Strings 3	121	1	50
Synth Strings2GM	121	0	51
Choir Aahs GM	121	0	52
Choir Aahs 2	121	1	52
Voice Oohs GM	121	0	53
Humming	121	1	53
Synth Voice GM	121	0	54
Analog Voice	121	1	54
Orchestra Hit GM	121	0	55
Bass Hit Plus	121	1	55
6th Hit	121	2	55
Euro Hit	121	3	55
Strings Ens.1 XG	0	0	48
Stereo Stringx	0	3	48
Slw Atk Strings	0	8	48
Arco Stringx	0	24	48
60's Strings X	0	35	48
Orchestra	0	40	48
Orchestra 2	0	41	48
TremoloOrchestra	0	42	48
Velocity Strings	0	45	48
Strings Ens.2 XG	0	0	49
StereoSlwStrings	0	3	49
SlwLegatoStrings	0	8	49
Warm Strings	0	40	49
Kingdom	0	41	49
70's Strings	0	64	49
Strings 3	0	65	49
Synth Strings1XG	0	0	50
Reso Strings	0	27	50
Synth Strings 4	0	64	50
Synth Strings 5	0	65	50
Synth Strings2XG	0	0	51
Choir Aahs XG	0	0	52

Sound	CC00	CC32	PC
Stereo Choir	0	3	52
Choir Aahs 3	0	16	52
Mellow Choir	0	32	52
Choir Strings	0	40	52
Voice Oohs XG	0	0	53
Synth Voice XG	0	0	54
Synth Voix	0	40	54
Choral	0	41	54
Analog Voix	0	64	54
Orchestra Hit XG	0	0	55
Orchestra Hitx	0	35	55
Impact	0	64	55
GM/XG/Brass			
Trumpet GM	121	0	56
Dark Trumpet	121	1	56
Trombone GM	121	0	57
Trombone 2	121	1	57
Bright Trombone	121	2	57
Tuba GM	121	0	58
Muted Trumpet GM	121	0	59
Mute Trumpet 7	121	1	59
French Horn GM	121	0	60
FrenchHorn Warm	121	1	60
Brass Section GM	121	0	61
Brass Section 2	121	1	61
Synth Brass 1 GM	121	0	62
Synth Brass 3	121	1	62
Analog Brass 1	121	2	62
Jump Brass	121	3	62
Synth Brass 2 GM	121	0	63
Synth Brass 4	121	1	63
Analog Brass 2	121	2	63
Trumpet XG	0	0	56
Trumpet 2	0	16	56

Sound	CC00	CC32	PC
Brite Trumpet	0	17	56
Trombone XG	0	0	57
Warm Trombone	0	18	57
Tuba XG	0	0	58
Tuba 2	0	16	58
Muted Trumpet XG	0	0	59
French Horn XG	0	0	60
French Horn Solo	0	6	60
Warm French Horn	0	32	60
Horn Orchestra	0	37	60
Brass Section XG	0	0	61
Tpt&Tbn Section	0	35	61
Brass Section 3	0	40	61
Hit Brass	0	41	61
Mellow Brass	0	42	61
Synth Brass 1 XG	0	0	62
Quack Brass	0	12	62
Res. Synth Brass	0	20	62
Poly Brass	0	24	62
Synth Brass 4 X	0	27	62
Jump Brass X	0	32	62
AnaVel Brass 1	0	45	62
AnaLog Brass 1	0	64	62
Synth Brass 2 XG	0	0	63
Soft Brass	0	18	63
Synth Brass X	0	40	63
Choir Brass	0	41	63
AnaVel Brass 2	0	45	63
AnaLog Brass 2	0	64	63
GM/XG/Reed			
Soprano Sax GM	121	0	64
Alto Sax GM	121	0	65
Tenor Sax GM	121	0	66
Baritone Sax GM	121	0	67

Sound	CC00	CC32	PC
Oboe GM	121	0	68
English Horn GM	121	0	69
Bassoon GM	121	0	70
Clarinet GM	121	0	71
Soprano Sax XG	0	0	64
Alto Sax XG	0	0	65
Sax Section	0	40	65
HyperAltoSax	0	43	65
Tenor Sax XG	0	0	66
BreathyTenorSax	0	40	66
Soft Tenor Sax	0	41	66
Classic Tenor Sax	0	64	66
Baritone Sax XG	0	0	67
Oboe XG	0	0	68
English Horn XG	0	0	69
Bassoon XG	0	0	70
Clarinet XG	0	0	71
GM/XG/Pipe			
Piccolo GM	121	0	72
Flute GM	121	0	73
Recorder GM	121	0	74
Pan Flute GM	121	0	75
Blown Bottle GM	121	0	76
Shakuhachi GM	121	0	77
Whistle GM	121	0	78
Ocarina GM	121	0	79
Piccolo XG	0	0	72
Flute XG	0	0	73
Recorder XG	0	0	74
Pan Flute XG	0	0	75
Blown Bottle XG	0	0	76
Shakuhachi XG	0	0	77
Whistle XG	0	0	78
Ocarina XG	0	0	79

Sound	CC00	CC32	PC
GM/XG/Syn Lead Syn Pad			
Lead Square GM	121	0	80
Lead Square 2	121	1	80
Lead Sine	121	2	80
Lead Saw GM	121	0	81
Lead Saw 2	121	1	81
Lead Saw & Pulse	121	2	81
Lead Double Saw	121	3	81
Lead Seq. Analog	121	4	81
Calliope GM	121	0	82
Chiff GM	121	0	83
Charang GM	121	0	84
Wire Lead	121	1	84
Voice Lead GM	121	0	85
Fifths Lead GM	121	0	86
Bass & Lead GM	121	0	87
Lead Soft Wrl	121	1	87
New Age Pad GM	121	0	88
Warm Pad GM	121	0	89
Sine Pad	121	1	89
Polysynth GM	121	0	90
Choir Pad GM	121	0	91
Itopia Pad	121	1	91
Bowed Glass GM	121	0	92
Metallic Pad GM	121	0	93
Halo Pad GM	121	0	94
Sweep Pad GM	121	0	95
Lead Square XG	0	0	80
Square Lead	0	6	80
LM Square	0	8	80
Hollow	0	18	80
Shroud	0	19	80
Mellow	0	64	80

Sound	CC00	CC32	PC
Solo Sine	0	65	80
Sine Lead	0	66	80
Lead Saw XG	0	0	81
Sawtooth Lead	0	6	81
Thick Sawtooth	0	8	81
Dynamic Sawtooth	0	18	81
Digital Saw	0	19	81
Big Lead	0	20	81
Heavy Synth	0	24	81
Wasp Synth	0	25	81
Pulse Saw	0	40	81
Dr. Lead	0	41	81
Velocity Lead	0	45	81
Sequenced Analog	0	96	81
Calliope XG	0	0	82
Pure Lead	0	65	82
Chiff XG	0	0	83
Rubby	0	64	83
Charang XG	0	0	84
Distorted Lead	0	64	84
Wire Lead X	0	65	84
Voice Lead XG	0	0	85
Synth Aahs	0	24	85
Vox Lead	0	64	85
Fifths Lead XG	0	0	86
Big Five	0	35	86
Bass & Lead XG	0	0	87
Big & Low	0	16	87
Fat & Perky	0	64	87
Soft Whirl	0	65	87
New Age Pad XG	0	0	88
Fantasy	0	64	88
Warm Pad XG	0	0	89

Sound	CC00	CC32	PC
Thick Pad	0	16	89
Soft Pad	0	17	89
Sine Pad X	0	18	89
Horn Pad	0	64	89
Rotary Strings	0	65	89
Polysynth XG	0	0	90
Poly Pad 800	0	64	90
Click Pad	0	65	90
Analog Pad	0	66	90
Square Pad X	0	67	90
Choir Pad XG	0	0	91
Heaven Mod	0	64	91
Itopia	0	66	91
C.C. Pad	0	67	91
Bowed Glass XG	0	0	92
Glacier	0	64	92
Metallic Pad XG	0	0	93
Tine Pad	0	64	93
Pan Pad	0	65	93
Halo Pad XG	0	0	94
Sweep Pad XG	0	0	95
Shwimmer	0	20	95
Converge	0	27	95
Polar Pad	0	64	95
Celestial	0	66	95
GM/XG/Synth SFX			
Ice Rain GM	121	0	96
Soundtrack GM	121	0	97
Crystal GM	121	0	98
Synth Mallets 4	121	1	98
Atmosphere GM	121	0	99
Brightness GM	121	0	100
Goblins GM	121	0	101

Sound	CC00	CC32	PC
Echo Drops GM	121	0	102
Echo Bell	121	1	102
Echo Pan	121	2	102
Star Theme GM	121	0	103
Ice Rain XG	0	0	96
Clav. Pad	0	45	96
Harmo. Rain	0	64	96
African Wind	0	65	96
Carib	0	66	96
Soundtrack XG	0	0	97
Prologue	0	27	97
Ancestral Clouds	0	64	97
Crystal XG	0	0	98
Synth Drum Comp.	0	12	98
Popcorn	0	14	98
Tiny Bells	0	18	98
Round Glocken.	0	35	98
Glocken. Chimes	0	40	98
Clear Bells	0	41	98
Chorus Bells	0	42	98
Synth Mallet X	0	64	98
Soft Crystal	0	65	98
LoudGlockenspiel	0	66	98
Xmas Bell	0	67	98
Vibe Bells	0	68	98
Digital Bells	0	69	98
Air Bells	0	70	98
Bell Harp	0	71	98
Gamelimba	0	72	98
Atmosphere XG	0	0	99
Warm Atmosph.	0	18	99
Hollow Release	0	19	99
Nylon El. Piano	0	40	99

Sound	CC00	CC32	PC
Nylon Harp	0	64	99
Harp Vox	0	65	99
Atmosphere Pad	0	66	99
Planet	0	67	99
Brightness XG	0	0	100
Fantasy Bells	0	64	100
Smokey	0	96	100
Goblins XG	0	0	101
Goblin Synth	0	64	101
Creepier	0	65	101
Ring Pad	0	66	101
Ritual	0	67	101
To Heaven	0	68	101
Night	0	70	101
Glisten	0	71	101
Bell Choir X	0	96	101
Echo Drops XG	0	0	102
Echoes	0	8	102
Echo Pan X	0	14	102
Echo Bell X	0	64	102
Big Pan	0	65	102
Synth Piano 2	0	66	102
Creation	0	67	102
Star Dust	0	68	102
Pan Reso X	0	69	102
Star Theme XG	0	0	103
Starz	0	64	103
GM/XG/Ethnic			
Sitar GM	121	0	104
Sitar 4	121	1	104
Banjo GM	121	0	105
Shamisen GM	121	0	106
Koto GM	121	0	107
Taisho Koto	121	1	107

Sound	CC00	CC32	PC
Kalimba GM	121	0	108
Bag Pipes GM	121	0	109
Fiddle GM	121	0	110
Shanai GM	121	0	111
Sitar XG	0	0	104
Detuned Sitar	0	32	104
Octave Sitar	0	35	104
Tamboura	0	97	104
Banjo XG	0	0	105
Muted Banjo	0	28	105
Rabab	0	96	105
Gopichant	0	97	105
Oud 3	0	98	105
Shamisen XG	0	0	106
Koto XG	0	0	107
Taisho-Kin	0	96	107
Kanoun X	0	97	107
Kalimba XG	0	0	108
Bag Pipes XG	0	0	109
Fiddle XG	0	0	110
Shanai XG	0	0	111
GM/XG/Percussive			
Tinkle Bell GM	121	0	112
Agogo GM	121	0	113
Steel Drums GM	121	0	114
Woodblock GM	121	0	115
Castanets	121	1	115
Taiko Drum GM	121	0	116
Concert BassDrum	121	1	116
Melodic Tom GM	121	0	117
Melodic Tom 2	121	1	117
Synth Drum GM	121	0	118
Rhythm Box Tom	121	1	118
Electric Drum	121	2	118

Sound	CC00	CC32	PC
ReverseCymbalGM	121	0	119
Tinkle Bell XG	0	0	112
Bonang	0	96	112
Altair	0	97	112
Gamelan Gongs	0	98	112
St.GamelanGongs	0	99	112
Rama Cymbal	0	100	112
Asian Bells	0	101	112
Agogo XG	0	0	113
Steel Drums XG	0	0	114
Glass Percussion	0	97	114
Thai Bells	0	98	114
Woodblock XG	0	0	115
Castanex	0	96	115
Taiko Drum XG	0	0	116
Gran Cassa	0	96	116
Melodic Tom XG	0	0	117
Melodic Tom 3	0	64	117
Real Tom	0	65	117
Rock Tom	0	66	117
Synth Drum XG	0	0	118
Analog Tom	0	64	118
Electric Perc.	0	65	118
ReverseCymbalXG	0	0	119
GM/XG/SFX			
Gtr FretNoise GM	121	0	120
Guitar Cut Noise	121	1	120
Ac. Bass String	121	2	120
Breath Noise GM	121	0	121
Flute Key Click	121	1	121
Seashore GM	121	0	122
Rain	121	1	122
Thunder	121	2	122
Wind	121	3	122

Sound	CC00	CC32	PC
Stream	121	4	122
Bubble	121	5	122
Bird Tweet GM	121	0	123
Dog	121	1	123
Horse Gallop	121	2	123
Bird Tweet 2	121	3	123
Telephone GM	121	0	124
Telephone 2	121	1	124
Door Creaking	121	2	124
Door	121	3	124
Scratch	121	4	124
Wind Chime	121	5	124
Helicopter GM	121	0	125
Car Engine	121	1	125
Car Stop	121	2	125
Car Pass	121	3	125
Car Crash	121	4	125
Siren	121	5	125
Train	121	6	125
Jetplane	121	7	125
Starship	121	8	125
Burst Noise	121	9	125
Applause GM	121	0	126
Laughing	121	1	126
Screaming	121	2	126
Punch	121	3	126
Heart Beat	121	4	126
Footsteps	121	5	126
Gun Shot GM	121	0	127
Machine Gun	121	1	127
Laser Gun	121	2	127
Explosion	121	3	127
Gtr FretNoise XG	0	0	120
Breath Noise XG	0	0	121

Sound	CC00	CC32	PC
Seashore XG	0	0	122
Bird Tweet XG	0	0	123
Telephone XG	0	0	124

Sound	CC00	CC32	PC
Helicopter XG	0	0	125
Applause XG	0	0	126
Gun Shot XG	0	0	127

Prepared Piano sampled at Kunitachi College of Music

Co-Development on Prepared Piano: Satoko Inoue

Co-Development: Kunitachi College of Music

For more information about Satoko Inoue, visit <http://www.n-b-music.com>

For more information about Kunitachi College of Music, visit <https://www.kunitachi.ac.jp>



国立音楽大学
KUNITACHI COLLEGE OF MUSIC

Electric Guitar sampled at Solent University recording studios UK.

Co-Development: Toni Diaz and Joe Burgess

For more information about Solent University, visit <https://www.solent.ac.uk>

SOLENT
UNIVERSITY
SOUTHAMPTON

Drum Kits

The following table lists all Factory Drum Kits as they appear in the **Sound Select** window. The **RR** abbreviation in a name means that the kit includes round-robin samples. The table also includes MIDI data used to remotely select the Sounds. **CC00**: Control Change 0, or Bank Select MSB. **CC32**: Control Change 32, or Bank Select LSB. **PC**: Program Change.

Drum Kit	CC00	CC32	PC
Factory/Drum			
Pop Kit 1 RR	120	0	100
Pop Kit 2 RR	120	0	101
Pop Kit 1 Amb	120	0	52
Vintage Kit 1 Amb	120	0	54
Rock Kit 1 Amb	120	0	55
Jazz Kit 1 RR	120	0	105
Jazz Kit 1 Amb	120	0	62
Funk Kit 1 Amb	120	0	53
Fusion Kit RR	120	0	106
Brush Kit 1 Amb	120	0	84
Pop Kit Pro 1 RR	120	0	102
Pop Kit Pro 2 RR	120	0	103
Pop Kit 2 Amb	120	0	70
Vintage Kit 2 Amb	120	0	94
Rock Kit 2 Amb	120	0	22
Jazz Kit Pro 1 RR	120	0	85
Jazz Kit Pro 2 RR	120	0	86
Gospel Kit Pro RR	120	0	104
Fusion Kit Pro RR	120	0	87
Brush Kit 2 Amb	120	0	45
Pop Kit 3 Amb	120	0	71
Pop Kit 4 Amb	120	0	88
Pop Std. Kit 1	120	0	89
Pop Std. Kit 2	120	0	90
Pop Std. Kit 3	120	0	4

Drum Kit	CC00	CC32	PC
Jazz Kit 2 Amb	120	0	83
Jazz Kit 3 Amb	120	0	36
Jazz Kit 4 Amb	120	0	37
Jazz Kit 1	120	0	33
Jazz Kit 2	120	0	34
Standard Kit 1	120	0	5
Standard Kit 2	120	0	1
Standard Kit 3	120	0	2
Standard Kit 4	120	0	6
Standard Kit Amb	120	0	93
Brush Kit 1	120	0	42
Brush Kit 2	120	0	43
Brush Kit 3	120	0	44
Jazz Kit 3	120	0	35
Brush Kit 3 Amb	120	0	46
Synth Kit 1	120	0	59
Synth Kit 2	120	0	58
Synth Kit 3	120	0	61
SFX Kit 1	120	0	60
SFX Kit 2	120	0	57
Drum & FX Kit 1	120	0	78
Drum & FX Kit 2	120	0	79
Slices A FX	121	4	118
Slices B FX	121	5	118
Percussion Kit 2	120	0	114
Analog Kit 1	120	0	107

Drum Kit	CC00	CC32	PC
Analog Kit 2	120	0	123
Elektronik Kit	120	0	108
FX Kit	120	0	112
Dub&Moomba Kit	120	0	113
Slice Kit 1	120	0	99
Slice Kit 2	120	0	109
Slice Kit 3	120	0	110
Slice Kit 4	120	0	111
Slice FX Kit	120	0	98
Electro Kit 1	120	0	75
Electro Kit 2	120	0	76
Electro Kit 3	120	0	122
House Kit 1	120	0	30
House Kit 2	120	0	31
Dance Kit	120	0	74
Dance Kit Remix	120	0	29
Trance Kit	120	0	63
HipHop Kit 1	120	0	9
HipHop Kit 2	120	0	72
Real Kit 1 Amb	120	0	81
Real Kit 2 Amb	120	0	82
Room Kit Amb	120	0	80
Cool Kit Amb	120	0	39
Gate Kit Amb	120	0	23
Power Kit 1 Amb	120	0	20
Power Kit 2 Amb	120	0	21
Power Kit 1	120	0	18
Power Kit 2	120	0	19
Turkish Kit	120	0	118
Groove Kit	120	0	77
Ambient Kit	120	0	3
Jungle Kit	120	0	10
Studio Kit	120	0	95
Lounge Kit Amb	120	0	38

Drum Kit	CC00	CC32	PC
Arabian Kit 1	120	0	51
Arabian Kit 2	120	0	117
Timpani	121	1	47
Reverse Tom	121	2	117
Reverse Cymbal	121	2	119
Standard Perc Kit	120	0	69
Percussion Kit 1	120	0	64
Latin Perc Kit 1	120	0	65
Latin Perc Kit 2	120	0	68
Brazil Perc Kit	120	0	115
Oriental Perc Kit	120	0	119
Trinity Perc Kit	120	0	66
i30 Perc Kit	120	0	67
Legacy/Drum & SFX			
Standard Kit 5	120	0	7
Bdrum&Sdrum Kit	120	0	50
Room Kit 1	120	0	120
Room Kit 2	120	0	12
Power Kit 3	120	0	121
Power Kit 4	120	0	17
HipHop Kit 3	120	0	13
Elektro Kit 1	120	0	96
Elektro Kit 2	120	0	97
Techno Kit 1	120	0	11
Techno Kit 2	120	0	73
Techno Kit 3	120	0	15
Techno Kit 4	120	0	14
House Kit 3	120	0	26
House Kit 4	120	0	27
House Kit 5	120	0	28
Brush Kit 4	120	0	125
Brush Kit 5	120	0	41
Orchestra Kit	120	0	49
Log Drum	121	4	12

Drum Kit	CC00	CC32	PC
Reverse Snare	121	3	118
Dragon Gong	121	1	119
Castanets Plus	121	2	115
Woodblock	121	3	115
Footstep Walk	121	7	126
GM/XG/Drum			
Standard Kit GM	120	0	0
Room Kit GM	120	0	8
Power Kit GM	120	0	16
Electro Kit GM	120	0	24
Analog Kit GM	120	0	25
Jazz Kit GM	120	0	32
Brush Kit GM	120	0	40

Drum Kit	CC00	CC32	PC
Orchestra Kit GM	120	0	48
SFX Kit GM	120	0	56
Standard Kit1 XG	127	0	0
Standard Kit2 XG	127	0	1
Room Kit XG	127	0	8
Rock Kit XG	127	0	16
Electro Kit XG	127	0	24
Analog Kit XG	127	0	25
Jazz Kit 1 XG	127	0	32
Jazz Kit 2 XG	127	0	33
Brush Kit XG	127	0	40
Classic Kit XG	127	0	48

DNC Sounds and controls

DNC Sounds are the Sounds programmed according to the DNC (Defined Nuance Control) system. This allows the performer to accurately and expressively introduce the most subtle nuances and sound articulation, by way of dedicated controls. The following table explains the meaning of the DNC controls.

DNC Control	Meaning
Legato (In)	Playing legato inside the Legato range (as defined in the Sound > Basic > Sound page, and shown in the previous table)
Legato (Out)	Playing legato out of the Legato range
After Touch	Deeper press on the key
Joystick Y+	Upward movement of the Joystick
Joystick Y-	Downward movement of the Joystick
SC1 Note On	Sound Controllers 1, 2 & 3 (SC1, SC2, SC3) are MIDI controllers that can be assigned to a physical control (assignable switch, footswitch, CONTROL button). They can be activated either by a Note On or a Note Off message.
SC1 Note Off	
SC2 Note On	For example, imagine you are playing an Accordion DN1-type Sounds, and SC1 is assigned to an assignable switch. The SC1 controller is programmed as a 'booking'-type control in Sound Edit (Sound > Basic > Sound page), therefore it will affect the next Note On or Note Off event. If you press the switch before playing a note (Note On), a Riff Up will be triggered when playing a note. If you press the switch while the note is playing, a Fall Down will be triggered when releasing the note (Note Off).
SC2 Note Off	
SC3 Note On	
SC3 Note Off	

Depending on the chosen Sounds and the assigned DNC functions, the SC1, SC2 and Y-controllers can either 'book' a function, that will be triggered while playing, or enable (or disable) it by pressing the button to 'toggle' it. When an SC1 or SC2 controller is assigned to an assignable switch, the indicator will show the DNC controllers status.

Indicator status	Meaning
Off	No DNC function assigned.
Red steady	Booking DNC function available.
Red blinking	Booking DNC function waiting to be executed. Then, it will return steady.
Green steady	Toggle DNC function available.
Green blinking	Toggle activated. Press it again to disable it.

The following table lists the DNC Sounds and their DNC controls. DNC, DN1 and DN2 Sounds use different sets of controls.

Sound Name	CC		PC	Legato		After Touch	Joystick		SC1		SC2		SC3	
	0	32		In	Out		Y+	Y-	Note On	Note Off	Note On	Note Off	Note On	Note Off
Factory/Piano														
VintageClavi1DNC	121	7	7							Pickup pos. 1 (toggle)		Pickup pos. 2 (toggle)		
VintageClavi2DNC	121	8	7							Pickup pos. 1 (toggle)		Pickup pos. 2 (toggle)		
Factory/Mallet & Bell														
Cymbalon DNC	121	2	15				Long	Long note off	Short		Short	Short note		
Factory/Accordion														
Harmonica 1 DN1	121	11	22	Legato Atk				Soft Atk	Riff Up	Riff Down	Riff Down	Fall Down		
Harmonica 1 DN2	121	12	22	Legato Atk	> ±9st: Riff Up/Dn			Soft Atk	Riff Up	Riff Down	Riff Down	Fall Down		
Harmonica 2 DN1	121	13	22	Legato Atk				Soft Atk	Riff Up	Riff Down	Riff Down	Fall Down		
Harmonica 3 DN1	121	14	22	Legato Atk				Soft Atk	Riff Up	Riff Down	Riff Down	Fall Down		
Bandoneon DNC	121	11	23				Tremolo	Expr.	Short Note		Stop Note			
Factory/Guitar														
Classic Gtr 1 DNC	121	29	24	Legato Atk		Vibrato		Body NZ	Slide Up		Harm			
Classic Gtr 2 DNC	121	20	24	Legato Atk		Vibrato		Body NZ	Slide Up		Harm			
Classic Gtr 3 DNC	121	18	24	Legato Atk		Vibrato		Body NZ	Slide Up		Harm			
7Str.Guitar DNC	121	28	24	Legato Atk		Vibrato		Mute	Slide Up		Harm			
Steel Guitar1 DNC	121	47	25			Vibrato		Mute	Slide Up		Harm			
Steel Guitar2 DNC	121	48	25			Vibrato		Mute	Slide Up		Harm			
Steel Guitar3 DNC	121	49	25			Vibrato		Mute	Slide Up		Harm			
Steel Guitar4 DNC	121	51	25			Vibrato		Mute	Slide Up		Harm			
Steel Guitar5 DNC	121	36	25	Legato Atk		Vibrato		Body NZ	Slide Up		Harm			
Strat N DI DNC	121	39	27			Vibrato			Slide Up		Harm			
Strat N CIn DNC	121	38	27			Vibrato			Slide Up		Mute			
Strat B DI DNC	121	45	27			Vibrato			Slide Up		Harm			
Strat B Ovd DNC	121	5	29			Vibrato		Feedback	Slide Up		Harm			
LesP M DI DNC	121	43	27			Vibrato			Slide Up		Harm			
LesP M CIn DNC	121	42	27			Vibrato			Slide Up		Harm			
33X B DI DNC	121	44	27			Vibrato			Slide Up		Harm			
33X B Dst DNC	121	17	30			Vibrato		Feedback	Slide Up		Harm			
Tele M DI DNC	121	41	27			Vibrato			Slide Up		Harm			
Tele M CIn DNC	121	40	27			Vibrato			Slide Up		Harm			

Sound Name	CC		PC	Legato		After Touch	Joystick		SC1		SC2		SC3	
	0	32		In	Out		Y+	Y-	Note On	Note Off	Note On	Note Off	Note On	Note Off
Jazz Guitar DNC	121	8	26	Legato Atk		Vibrato		Octave (toggle)	Slide Up		Harm			
Dobro DNC	121	50	25			Vibrato		Mute	Slide Up		Harm			
Stra.GtrUpDwDNC	121	33	27						Slide Up		Harm			
Distorted Gtr1DNC	121	16	30			Vibrato		Feedback	Slide Up		Harm			
Distorted Gtr2DNC	121	14	30	Legato Atk		Vibrato		Feedback	Slide Up		Harm			
Crunch Gtr DNC	121	3	29	Legato Atk		Vibrato		Feedback	Slide Up		Harm			
Folk Guitar DNC	121	34	25	Legato Atk		Vibrato		Body NZ	Slide Up		Harm			
Steel Guitar6 DNC	121	19	25	Legato Atk		Vibrato		Body NZ	Slide Up		Harm			
12 Str Guitar DNC	121	33	25	Legato Atk		Vibrato		Body NZ	Slide Up		Harm			
ViolaCaipira DNC	121	45	25	Legato Atk		Vibrato		Body NZ	Slide Up		Harm			
Factory/Strings & Vocal														
StringEnsembleDNC	121	13	49					Tremolo	Marcato	Spiccato		Pizzicato		
Ballad StringsDNC	121	17	49					Tremolo	Marcato	Spiccato		Pizzicato		
Violin 1 DN2	121	15	40	Legato Atk	> ±7st: Gliss Up/Dn			Tremolo		End		Pizzicato		Scale Up
Violin 2 DN1	121	16	40	Legato Atk				Tremolo	Marcato			Spiccato		Balzato
Violin 5 DN1	121	14	40	Legato Atk		More Vib.	Tremolo	Balzato	Détaché			Pizzicato		
Violin 6 DN2	121	13	40		> ±9st: Riff Up/Dn	More Vib.	Tremolo	Mordente	Riff Up	Fall Down	Gliss Down	Gliss Up		
Violin 7 DN1	121	12	40	Legato Atk		More Vib.		Mordente	Open String			Pizzicato		
Violin 8 DN2	121	10	40		> ±9st: Riff Up/Dn	More Vib.		Mordente	Gliss Up	Fall Down	Gliss Down	Gliss Up		
Violin 9 DN2	121	11	40		> ±9st: Riff Up/Dn	More Vib.		Mordente	Gliss Up	Fall Down	Gliss Down	Gliss Up		
Viola 1 DN2	121	4	41	Legato Atk	> ±7st: Gliss Up/Dn			Tremolo	Vibrato			Pizzicato		Riff Up
Viola 2 DN1	121	5	41	Legato Atk				Tremolo	Vibrato			Spiccato		Balzato
Viola 3 DN1	121	3	41			More Vib.	Tremolo	Balzato	Détaché			Pizzicato		
Cello 1 DN2	121	3	42	Legato Atk	> ±7st: Gliss Up/Dn			Tremolo		End		Pizzicato		Riff Up
Cello 2 DN1	121	4	42	Legato Atk				Tremolo	Marcato			Spiccato		Balzato
Double Bass 1 DN2	121	3	43	Legato Atk	> ±5st: Gliss Up/Dn			Tremolo	Marcato			Pizzicato		Balzato
Double Bass 2 DN1	121	4	43	Legato Atk				Tremolo	Marcato			Spiccato		Balzato

Sound Name	CC		PC	Legato		After Touch	Joystick		SC1		SC2		SC3	
	0	32		In	Out		Y+	Y-	Note On	Note Off	Note On	Note Off	Note On	Note Off
Soprano Vox 2 DNC	121	4	53	< ±6st: Smooth	> ±6st: Gliss Up/Dn				> G4: 4th Up		< F5: 5th Down			
Factory/Trumpet & Trbn														
Trumpet 1 DN2	121	38	56	Legato Atk	> ±5st: Gliss Up/Dn	More Vib.		Wah	Riff Up	Fall Down	Riff Down	Fall Down	Shake	
Trumpet 2 DN1	121	39	56			More Vib.		Wah	Riff Up	Fall Down	Riff Down	Fall Down	Shake	
Trumpet 3 DN2	121	40	56	Legato Atk	> ±5st: Gliss Up/Dn	More Vib.		Wah	Wah		Cup		Shake	
Jazz Trumpet DN1	121	33	56	Legato Atk		More Vib.		Alt Timbre	Gliss Up	Fall Down	Riff Down	Doit		
Jazz Trumpet DN2	121	34	56	Legato Atk	> ±9st: Riff Up/Dn	More Vib.		Alt Timbre	Gliss Up	Fall Down	Riff Down	Doit		
MexicoTrumpet1DN2	121	41	56	Legato Atk	> ±5st: Gliss Up/Dn	More Vib.		Swell	Riff Up	Fall Down	Riff Down	Fall Down	Shake	
MexicoTrumpet2DN2	121	42	56	Legato Atk	> ±5st: Gliss Up/Dn	More Vib.		Swell	Riff Up	Fall Down	Riff Down	Fall Down	Shake	
Mute Trumpet1 DN1	121	11	59	Legato Atk		More Vib.		Exp Filter	Wah		Wah Harm		Wah Growl	
Mute Trumpet2 DN2	121	10	59	Legato Atk	> ±3st: Riff Up/Dn	More Vib.		Staccato	Riff Up	Fall Down	Riff Down	Doit		
Mute Trumpet3 DN2	121	9	59	Legato Atk	> ±3st: Riff Up/Dn	More Vib.		Wah	Long Fall Down	Fall Down	Long Doit	Doit		
Mute Trumpet5 DN1	121	6	59	Legato Atk		More Vib.		Alt Timbre	Gliss Up	Fall Down	Riff Down	Doit		
Mute Trumpet6 DN1	121	7	59	Legato Atk		More Vib.		Alt Timbre	Gliss Up	Fall Down	Riff Down	Doit		
Wah Trumpet 1 DN1	121	12	59	Legato Atk			Wah Growl	Exp Filter	Cup		Wah Harm		Wah Plung	
Jazz Cornet DN1	121	32	56	Legato Atk		More Vib.		Alt Timbre	Gliss Up	Fall Down	Riff Down	Doit		
Jazz Cornet DN2	121	36	56	Legato Atk	> ±9st: Riff Up/Dn	More Vib.		Alt Timbre	Gliss Up	Fall Down	Riff Down	Doit		
Mute Cornet DN1	121	8	59	Legato Atk		More Vib.		Alt Timbre	Gliss Up	Fall Down	Riff Down	Doit		
Flugelhorn 1 DN2	121	37	56	Legato Atk	> ±3st: Riff Up/Dn	More Vib.		Staccato	Riff Up	Fall Down	Riff Down	Doit		
Trombone 1 DN1	121	26	57	< ±5st: Legato Atk & Port.		More Vib.		Crescendo	Gliss Up	Fall Down	Staccato		Doit	
Trombone 2 DN2	121	27	57	Legato Atk	> ±5st: Port. Up/Dn	More Vib.		Crescendo	Gliss Up	Fall Down	Staccato		Doit	
Trombone 3 DN2	121	28	57	Legato Atk	> ±5st: Port. Up/Dn	More Vib.		Staccato	Gliss Up	Fall Down	Gliss Down	Rel./Note Off	Doit	
Jazz Trombone DN1	121	20	57	Legato Atk		More Vib.		Alt Timbre	Gliss Up	Fall Down	Riff Down	Doit		
Jazz Trombone DN2	121	21	57	Legato Atk	> ±9st: Gliss Up/Dn	More Vib.		Alt Timbre	Gliss Up	Fall Down	Riff Down	Doit		

Sound Name	CC		PC	Legato		After Touch	Joystick		SC1		SC2		SC3	
	0	32		In	Out		Y+	Y-	Note On	Note Off	Note On	Note Off	Note On	Note Off
Soft Trombone DN1	121	22	57	Legato Atk		More Vib.		Alt Timbre	Gliss Up	Fall Down	Riff Down	Doit		
Soft Trombone DN2	121	23	57	Legato Atk	> ±9st: Gliss Up/Dn	More Vib.		Alt Timbre	Gliss Up	Fall Down	Riff Down	Doit		
HardTrombone DN1	121	24	57	Legato Atk		More Vib.		Alt Timbre	Gliss Up	Fall Down	Riff Down	Doit		
HardTrombone DN2	121	25	57	Legato Atk	> ±9st: Gliss Up/Dn	More Vib.		Alt Timbre	Gliss Up	Fall Down	Riff Down	Doit		
Factory/Brass														
Swing Horns DNC	121	40	61					Shake	Swell	Fall Down		Doit		
Horns Sweel1 DNC	121	38	61					Shake	SFX	Fall Down		Doit		
Horns Sweel2 DNC	121	39	61					Shake	SFX	Fall Down		Doit		
Trombones DNC	121	10	61					Shake	Swell	Fall Down		Doit		
Trumpets DNC	121	42	61					Shake	Swell	Fall Down		Doit		
Horns Swell3 DNC	121	45	61					Shake	Exp Filter	Fall Down		Doit		
Factory/Sax														
Soprano Sax 1 DN2	121	7	64	Legato Atk	> ±9st: Gliss Up/Dn	More Vib.	Grace note	Crescendo	Riff Up	Fall Down	Riff Down	Gliss Down	Half Tone Up	
Soprano Sax 2 DN1	121	6	64	Legato Atk	Legato Atk	More Vib.			Glide Up	Fall Down	Riff Down	Gliss Down		
Alto Sax 1 DN2	121	26	65	Legato Atk	> ±9st: Gliss Up/Dn	More Vib.		Crescendo	Riff Up	Fall Down	Riff Down	Gliss Down	Half Tone Up	
Alto Sax 2 DN2	121	27	65	Legato Atk	> ±9st: Gliss Up/Dn	More Vib.		Crescendo	Riff Up	Fall Down	Riff Down	Gliss Down	Half Tone Up	
Alto Sax 3 DN2	121	28	65	Legato Atk	> ±9st: Gliss Up/Dn	More Vib.		Crescendo	Riff Up	Fall Down	Riff Down	Gliss Down	Half Tone Up	
Alto Sax 4 DN1	121	22	65	Legato Atk	Legato Atk	More Vib.		Growl	Riff Up	Fall Down	Riff Down	Gliss Down		
Alto Sax 5 DN1	121	23	65	Legato Atk	Legato Atk	More Vib.		Growl	Grace Note	Fall Down	Short Riff Dn	Gliss Down		
Alto Sax 6 DN1	121	24	65	Legato Atk	Legato Atk	More Vib.		Growl	Grace Note	Fall Down	Short Riff Dn	Gliss Down		
Jazz Sax DN1	121	20	65	Legato Atk Up/Dn		More Vib.		Growl	Riff Up	Fall Down	Riff Down	Gliss Down		
Jazz Sax DN2	121	21	65	Legato Atk	> ±9st: Riff Up/Dn	More Vib.		Growl	Riff Up	Fall Down	Riff Down	Gliss Down		
Tenor Sax 1 DN2	121	23	66	Legato Atk	> ±9st: Riff Up/Dn			Crescendo	Riff Up	Fall Down	Riff Down	Gliss Down	Half Tone Up	
Tenor Sax 2 DN1	121	16	66	Legato Atk Up/Dn		More Vib.		Growl	Riff Up	Fall Down	Riff Down	Gliss Down		
Tenor Sax 3 DN2	121	17	66	Legato Atk	> ±9st: Riff Up/Dn	More Vib.		Growl	Riff Up	Fall Down	Riff Down	Gliss Down		

Sound Name	CC		PC	Legato		After Touch	Joystick		SC1		SC2		SC3	
	0	32		In	Out		Y+	Y-	Note On	Note Off	Note On	Note Off	Note On	Note Off
Tenor Sax 4 DN1	121	19	66	Legato Atk Up/Dn		More Vib.		Growl	Riff Up	Fall Down	Riff Down	Gliss Down		
Tenor Sax 5 DN2	121	20	66	Legato Atk	> ±9st: Riff Up/Dn	More Vib.		Growl	Riff Up	Fall Down	Riff Down	Gliss Down		
Soft Tenor DN1	121	21	66	Legato Atk Up/Dn		More Vib.		Growl	Riff Up	Fall Down	Riff Down	Gliss Down		
Soft Tenor DN2	121	22	66	Legato Atk	> ±9st: Riff Up/Dn	More Vib.		Growl	Riff Up	Fall Down	Riff Down	Gliss Down		
Tenor Growl DN1	121	18	66	Legato Atk Up/Dn		More Vib.		Growl	Riff Up	Fall Down	Riff Down	Gliss Down		
Bariton Sax 1 DN2	121	7	67	Legato Atk	> ±9st: Riff Up/Dn			Crescendo	Riff Up	Fall Down	Riff Down	Gliss Down	Half Tone Up	
Baritone Sax 2 DN1	121	6	67	Legato Atk Up/Dn		More Vib.		Growl	Riff Up	Fall Down	Riff Down	Gliss Down		
Factory/Woodwind														
Clarinet 1 DN2	121	24	71	Legato Atk	> ±9st: Riff Up/Dn	More Vib.		Gliss Up	Riff 4th Up	Fall Down	Riff 4th Down	Fall Down	Cresc.	
Clarinet 2 DN1	121	21	71	Legato Atk		More Vib.		Alt Timbre	Riff Up	Gliss Down	Riff Down	Gliss Down		
Folk Clarinet DN2	121	25	71	Legato Atk	> ±9st: Riff Up/Dn	More Vib.		Fall Down	Riff 4th Up	Fall Down	Riff 4th Down	Fall Down	Fast Fall Staccato	
Jazz Clarinet DN1	121	22	71	Legato Atk		More Vib.		Alt Timbre	Riff Up	Fall Down	Riff 4th Down	Gliss Down		
Kletzmer Clar1 DN2	121	26	71	Legato Atk	> ±9st: Riff Up/Dn	More Vib.		Half Tone Up	Soft Breath Expr.		Extreme Vibrato		Fast Fall Staccato	
Kletzmer Clar2 DN1	121	27	71	Legato Atk				Half Tone Up	Mezzo Forte Expr.		Extreme Vibrato		Fast Fall Staccato	
ConcertFlute DN1	121	15	73	Legato Atk Up/Dn		More Vib.		Frull	Riff Up	Fall Down	Gliss Up	Gliss Down		
ConcertFlute DN2	121	16	73	Legato Atk	> ±9st: Riff Up/Dn	More Vib.		Frull	Riff Up	Fall Down	Gliss Up	Gliss Down		
Latin Flute DN1	121	17	73	Legato Atk Up/Dn		More Vib.		Frull	Riff Up	Fall Down	Gliss Up	Gliss Down		
Latin Flute DN2	121	18	73	Legato Atk	> ±9st: Riff Up/Dn	More Vib.		Frull	Riff Up	Fall Down	Gliss Up	Gliss Down		
Bassoon 1 DNC	121	2	70			More Vib.			Staccato		Alt Timbre			
Pan Flute DN1	121	5	75	Legato Atk		More Vib.		Alt Attack	Riff Up	Fall Down	Gliss Up	Gliss Down		
Whistle 1 DN1	121	6	78			More Vib.		Alt Timbre	Riff Up	Fall Down	Riff Down	Gliss Down		
Factory/Synth Pad														
S&H Pad DNC	121	10	96			HP Filter	Reson.	Detune	White Noise		RND filter			

Sound Name	CC		PC	Legato		After Touch	Joystick		SC1		SC2		SC3	
	0	32		In	Out		Y+	Y-	Note On	Note Off	Note On	Note Off	Note On	Note Off
Factory/Synth Lead														
Next Dance DNC	121	13	87			Reson.	Filter	LP Filter		White Noise			Alt Timbre	
Noised Lead DNC	121	20	87			Filter		Alt Attack		White Noise			Alt Timbre	
Deep Modul. DNC	121	10	84				LFO Speed Increase	LFO Speed Decrease		HP Filter			Alt Attack	
Lab Synth DNC	121	8	84			Reson.		LP Filter		HP Filter			Detune	
Thin PulSeq DNC	121	21	81					HP Filter		White Noise			Alt Timbre	
Factory/Ethnic														
Mandolin DNC	121	40	25	Legato Atk						No Rel.				
Berimbau DNC	121	2	106				Belly			Caxixi			Crash	
Berimbau Rel.DNC	121	1	106				Belly			Caxixi			Bend	
Banjo Thumb DNC	121	6	105					Mute		Mordente			Harm	
Banjo Fing/ThuDNC	121	7	105					Mute		Thumb			Harm	
Factory/Bass														
JBass Fing DN1	121	29	33			Vibrato		Ghost		Mute			Harm	
JBass Fing DN2	121	30	33			Vibrato		Mute		Pick			Slap	
JBass Pick DN1	121	18	34			Vibrato		Ghost		Mute			Harm	
JBass Pick DN2	121	19	34			Vibrato		Mute		Finger			Slap	
SRBass Fing DN1	121	27	33			Vibrato		Ghost		Mute			Harm	
SRBass Fing DN2	121	28	33			Vibrato		Mute		Pick			Slap	
SRBass Pick DN1	121	16	34			Vibrato		Ghost		Mute			Harm	
SRBass Pick DN2	121	17	34			Vibrato		Mute		Finger			Slap	
PBass 1 Fing DN1	121	33	33			Vibrato		Ghost		Mute			Harm	
PBass 1 Fing DN2	121	34	33			Vibrato		Mute		Pick			Slap	
FSBass Pick DN1	121	14	34			Vibrato		Ghost		Mute			Harm	
FSBass Pick DN2	121	15	34			Vibrato		Mute		Finger			Slap	
PBass 2 Fing DN1	121	25	33			Vibrato		Ghost		Mute			Harm	
FretlessBass1 DN1	121	11	35			Vibrato		Ghost		Mute			Harm	
FretlessBass2 DN1	121	10	35			Vibrato		Ghost		Mute			Harm	
PBass 2 Fing DN2	121	26	33			Vibrato		Mute		Pick			Slap	
Finger Bass DN1	121	16	33			Vibrato		Ghost		Mute			Harm	
DarkSlap Bass DN1	121	7	36			Vibrato		Ghost		Mute			Harm	

Multisamples

The following table contains all the Factory Multisamples as they appear in the **Sound Edit** mode.

#	Multisample	#	Multisample
0	Grand Piano 1 OT	28	Acoustic Piano Res OT
1	Grand Piano 2 OT	29	Acoustic Piano Res
2	Grand Piano 3 OT	30	Grand Piano Leakage
3	Grand Piano 4 OT	31	Piano Hammer noise
4	Grand Piano 5 OT	32	Piano FX Pedal On
5	Grand Piano 6 OT	33	Piano FX Pedal Off
6	Grand Piano Res 1 OT	34	Piano FX Key Off
7	Grand Piano Res 2 OT	35	Baby Grand L
8	Grand Piano Res 3 OT	36	Baby Grand R
9	Grand Piano Res 4 OT	37	Upright Piano mf
10	Grand Piano Res 5 OT	38	Upright Piano f
11	Grand Piano Res 6 OT	39	E.GrandPiano 1
12	Grand Piano 1	40	E.GrandPiano 2
13	Grand Piano 2	41	Piano M1
14	Grand Piano 3	42	E.Piano PO 1
15	Grand Piano 4	43	E.Piano PO 2
16	Grand Piano 5	44	E.Piano PO 3
17	Grand Piano 6	45	E.Piano PO 4
18	Grand Piano Res 1	46	E.Piano PO 5
19	Grand Piano Res 2	47	E.Piano PO 6
20	Grand Piano Res 3	48	E.Piano PO 7
21	Grand Piano Res 4	49	E.Piano PO Kof p
22	Grand Piano Res 5	50	E.Piano PO Kof f
23	Grand Piano Res 6	51	E.Piano Rx Kon
24	Acoustic Piano p OT	52	E.Piano Rx Kof
25	Acoustic Piano f OT	53	E.Piano Suit Bright p
26	Acoustic Piano p	54	E.Piano Suit Bright mf
27	Acoustic Piano f	55	E.Piano Suit Bright f

#	Multisample
56	E.Piano Dyno p
57	E.Piano Dyno mf
58	E.Piano Dyno f
59	E.Piano Dyno Soft
60	E.Piano Dyno SoftLP
61	E.Piano Stage Hard
62	E.Piano Stage HardLP
63	E.Piano Vintage 1
64	E.Piano Vintage 2
65	E.Piano Vintage 3
66	E.Piano Vintage 4
67	E.Piano Vintage 5
68	E.Piano Vintage 6
69	E.Piano Vintage Koff
70	E.Piano Wurly Soft
71	E.Piano Wurly Hard
72	E.Piano FM AB 1
73	E.Piano FM AB 2
74	E.Piano FM AB 3
75	E.Piano FM EF 1
76	E.Piano FM EF 2
77	E.Piano FM EF 3
78	E.Piano FM EF 4
79	E.Piano FM 1
80	E.Piano FM 1LP
81	E.Piano FM 2
82	E.Piano Pad 1
83	E.Piano Pad 1LP
84	E.Piano Pad 2
85	Clav. BC 1
86	Clav. BC 2
87	Clav. BC 3
88	Clav. BC 4
89	Clav. 1

#	Multisample
90	Clav. 2
91	Clav. 3
92	Clav. 4
93	Clav. GM
94	Harpsichord1
95	Harpsichord1 Key Off
96	Harpsichord1 Release
97	Harpsichord1 Bump On
98	Harpsichord1 Bump Off
99	Harpsichord2
100	Harpsichord2 Key Off
101	Gospel Organ Slow L
102	Gospel Organ Slow R
103	Gospel Organ Fast L
104	Gospel Organ Fast R
105	16' 8' LF
106	16' 8' LS
107	16' 8' 51/3 LF
108	16' 8' 51/3 LS
109	4' 22/3' 2' LF
110	4' 22/3' 2' LS
111	11/3' 13/5' 1' LF
112	11/3' 13/5' 1' LS
113	16' 8' 51/3' Perc LF
114	16' 8' 51/3' Perc LS
115	Theater Organ 1
116	Theater Organ 2
117	50s E.Organ Bright
118	50s E.Organ Dark
119	E.Organ CX 3
120	E.Organ Perc. 01W
121	E.Organ Fast Click
122	E.Organ Perc. 1
123	E.Organ Perc. 2

#	Multisample
124	E.Organ Perc. 3
125	E.Organ Perc. 4
126	Organ 1 M1
127	Organ 2 M1
128	Organ 1
129	Organ 2
130	Organ 2LP
131	Organ 3 Jazz
132	BX3 & Perc. 3rd
133	E.Organ Vox
134	E.Organ Soft
135	E.Organ Full
136	E.Organ Dist
137	Rotary Organ 1
138	Rotary Organ 1LP
139	Rotary Organ 2
140	Super BX3
141	Super BX3LP
142	Rotor Noise LF
143	Rotor Noise LS
144	H Organ Leakage
145	H Organ 2nd Harmonic
146	H Organ Click Kon
147	H Organ Click Koff
148	ON-Click (Organ)
149	OFF-Click (Organ)
150	Pipe Flute L
151	Pipe Flute R
152	Pipe Positive
153	Pipe Mixture
154	Pipe Full 1 L
155	Pipe Full 1 R
156	Pipe Full 2
157	E.Organ Church

#	Multisample
158	El Organ Toy
159	Music Box
160	Music BoxLP
161	Kalimba
162	Kalimba GM
163	Marimba
164	MarimbaLP
165	Xylophone
166	Balaphone
167	Vibraphone1
168	Vibraphone1LP
169	Vibraphone2
170	Celesta
171	Celesta GM
172	CelestaLP
173	Glockenspiel
174	GlockenspiellLP
175	Tubular Bell
176	Log Drum
177	Steel Drum Hard
178	Steel Drum GM
179	Steel Drum HardLP
180	Gamelan
181	FM Bell
182	Flute mf
183	Flute f
184	Flute Chiff
185	Flute Singed
186	Flute Flutter
187	Flute Fall Down
188	Flute Riff Up
189	Flute Gliss Down Sus
190	Flute
191	Flute Falls

#	Multisample
192	Flute Gliss Up
193	Flute Gliss Down
194	Flute Frull
195	Flute Voice
196	Flute Jazz
197	Flute Vibrato
198	Flute Attack p
199	Flute Attack f
200	Breath Noise RX
201	Piccolo
202	Pan Flute
203	Pan Flute Attack
204	Tin Whistle
205	Tin Whistle Voice
206	Tin Whistle Attack
207	Whistle Gliss
208	Whistle Straight
209	Whistle Sfz Vibr
210	Whistle Sfz No Vibr
211	Whistle Slow Atk Vibr
212	Whistle Breath
213	Shakuhachi
214	Shakuhachi Atk
215	Shakuhachi Mid
216	Shakuhachi High
217	Bottle
218	Bottlizer
219	Shanai GM
220	Recorder
221	Ocarina
222	Clarinet 1 Vibrato p
223	Clarinet 1 Vibrato f
224	Clarinet 1 GlissUp
225	Clarinet 1 GlissUp Sus

#	Multisample
226	Clarinet 1 Fall
227	Clarinet 2
228	Clarinet 3
229	Double Reed M1
230	Oboe 1 Vibrato
231	Oboe 2 Straight
232	Oboe key noises
233	Oboe Get a Breath
234	English Horn
235	Bassoon 1
236	Bassoon 1 Vibrato
237	Bassoon 1 Staccato
238	Bassoon 2
239	Baritone Sax p
240	Baritone Sax f
241	Baritone Sax Growl
242	Baritone Sax GM
243	Tenor Sax Vib 1
244	Tenor Sax Vib 2
245	Tenor Sax Vib 3
246	Tenor Sax Vib 4
247	Tenor Sax Glissando
248	Tenor Sax Falls
249	Tenor Sax Straight
250	Tenor Sax Riff Up
251	Tenor Sax Fall Down
252	Tenor Sax Vibrato
253	Tenor Sax Expressive
254	Tenor Sax p
255	Tenor Sax mf
256	Tenor Sax f
257	Tenor Sax M1
258	Tenor Sax GM
259	Alto Sax Vib 1

#	Multisample
260	Alto Sax Vib 2
261	Alto Sax Vib 2 Drive
262	Alto Sax p
263	Alto Sax f
264	Alto Sax GM
265	Alto Sax Growl
266	Soprano Sax Vibrato
267	Soprano Sax Straight
268	Soprano Sax GM
269	Sax Family Vibrato
270	Sax key on
271	Sax key off
272	Sax breath
273	Tsax sfp<
274	Musette 1
275	Musette 2
276	Musette 2LP
277	Musette 3
278	Accordion 16'
279	Accordion 16' OT
280	Accordion 8'
281	Accordion 8' OT
282	Accordion 4'
283	Accordion 4' OT
284	Accordion preset 1
285	Accordion preset 2
286	Accordion Bassoon
287	Accordion Clarinet
288	Accordion Bandoneon
289	Accordion Volkst.
290	Accordion Bass
291	Accordion Noise KeyOn
292	Accordion Noise KeyOff
293	Accordion Change Voice

#	Multisample
294	Harmonica 1
295	Harmonica 1 Fall
296	Harmonica 2
297	Harmonica 3 Wah
298	Melodica
299	MelodicaKey On
300	MelodicaKey Off
301	Highland Bag Pipes
302	Highland Drones
303	Uilleann Pipes
304	Bag Pipes
305	Bag Pipes GM
306	French Horn 1 p
307	French Horn 1 mf
308	French Horn 1 f
309	French Horn 1 ff
310	French Horn 2 Close
311	French Horn 2 Open
312	French Horn T1
313	Tenor Horn
314	2Horns Str p
315	2Horns Str mf
316	2Horns Str f
317	2Horns Str ff
318	2Horns Stacc p
319	2Horns Stacc mf
320	2Horns Stacc f
321	2Horns Stacc ff
322	French Horn Ensemble
323	French Horns GM
324	Flugelhorn Vib light p
325	Flugelhorn Vib light mf
326	Flugelhorn Vib light f
327	Flugelhorn Vib light ff

#	Multisample
328	Flugelhorn Staccato p
329	Flugelhorn Staccato f
330	Flugel Octave Up p
331	Flugel Octave Up f
332	Flugel Octave Dw p
333	Flugel Octave Dw f
334	Flugel Falls p
335	Flugel Falls f
336	Flugel Horn Vibrato
337	Flugel Horn M1
338	Flugel Atk Noise
339	Euphonium Vibrato p
340	Euphonium Vibrato f
341	Euphonium Staccato p
342	Euphonium Staccato f
343	Tuba p
344	Tuba f
345	Tuba GM
346	Tuba Bariton Attack
347	Trombone 1 p
348	Trombone 1 mf
349	Trombone 1 f
350	Trombone 1 Gliss Up
351	Trombone 1 Fall
352	Trombone 1 Smear
353	Trombone 1 Smear Atk
354	Trombone 2 Vibrato
355	Trombone 3 mf
356	Trombone 3 f
357	Trombone 4 Soft
358	Trombone 4 Bright
359	Trombone 5 Straight fff
360	Trombone Slur Up
361	Trombone Fall

#	Multisample
362	Trombone GM
363	Trombone Muted
364	2 Trombones mf
365	2 Trombones f
366	2 Trombones Str p
367	2 Trombones Str f
368	2 Trombones Sfp<
369	2 Trombones Shake
370	2 Trombones Fall
371	2 Trombones Glissup
372	Classic Trumpet p
373	Classic Trumpet f
374	Pop Trumpet p
375	Pop Trumpet f
376	Trumpet Expr.
377	Trumpet Slow p
378	Trumpet Slow f
379	Trumpet GM
380	Trumpet Tonguing p
381	Trumpet Tonguing f
382	Trumpet Medium
383	Trumpet Overblown
384	Trumpet Muted
385	Trumpet Muted GM
386	Trumpet Wah
387	Trumpet WDH Vib
388	Trumpet WDH Shakes
389	Trumpet WDH Shakes Atk
390	Trumpet WDH Shakes Rel
391	Trumpet Doit
392	Trumpet Fall
393	TRP CupMute Vib p
394	TRP CupMute Vib mf
395	TRP CupMute Vib f

#	Multisample
396	TRP CupMute Wha Vib
397	TRP CupMute Wha Fast
398	TRP CupMute Wha Growl
399	TRP CupMute Dw 4th
400	TRP CupMute Up 4th
401	TRP CupMute Fall p
402	TRP CupMute Doit
403	TRP MuteHarm Vib p
404	TRP MuteHarm Vib mf
405	TRP MuteHarm Vib f
406	TRP MuteHarm Stac p
407	TRP MuteHarm Stac f
408	TRP MuteHarm Dw
409	TRP MuteHarm Up
410	TRP MuteHarm Doit
411	TRP MuteHarm Falls
412	TRP MuteHarm Bump Atk
413	TRP Basic Noise
414	2 Trumpets p
415	2 Trumpets f
416	2 Trumpets Str mf
417	2 Trumpets Str ff
418	2 Trumpets Sfp<
419	2 Trumpets Shake
420	2 Trumpets Fall
421	2 Trumpets Glissup
422	2Tp 2Tb Hit (SFX)
423	Brass Ensemble Stereo
424	Brass Ensemble 1
425	Brass Ensemble 2
426	Brass Ensemble 2LP
427	Brass Ensemble GM
428	Soprano Movie
429	Soprano Night

#	Multisample
430	Soprano Voice
431	Soprano Voice AD
432	Soprano Voice 5thDw
433	Soprano Voice 4thUp
434	Voice Female Wuh
435	Voice Female Woh
436	Voice Female Wah
437	Voice Female Dah
438	Voice Male Wuh
439	Voice Male Woh
440	Voice Male Wah
441	Voice Male Dah
442	Voice Scat Buh
443	Voice Scat Duh
444	Voice Scat Bah
445	Voice Scat Dah
446	Voice Choir
447	Voice Hoo
448	Voice Pop Ooh
449	Voice Pop Ah
450	Voice Doo
451	Voice DooLP
452	Choir Ahh Male/Fem p
453	Choir Ahh Male/Fem f
454	Choir Ohh Male/Fem
455	Choir Uhh Male/Fem
456	Choir Da Male/Fem
457	Choir Di Male/Fem
458	Choir Du Male/Fem
459	Choir La Male/Fem
460	Choir Pa Male/Fem
461	Choir Tu Male/Fem
462	Choir Humming M/F
463	Choir Whisper Female

#	Multisample
464	Choir Whisper Male
465	Violin 1 Espressive p
466	Violin 1 Espressive mf
467	Violin 1 Espressive f
468	Violin 1 Detache Vib p
469	Violin 1 Detache Vib f
470	Violin 1 Balzato 1
471	Violin 1 Balzato 2
472	Violin 1 Sforzato
473	Violin 1 Tremolo
474	Violin 1 Pizzicato 1
475	Violin 1 Pizzicato 2
476	Violin 1 Play Up
477	Violin 1 Play End
478	Violin 1 Bow Noise
479	Violin 2 Classic
480	Violin 2 Gliss Up
481	Violin 2 Gliss Dw
482	Violin 2 Strings Free
483	Violin 2 Trill Up
484	Violin 3 Solo Vibrato
485	Violin 3 Straight
486	Violin GM
487	Fiddle GM
488	Viola 1 Espressive p
489	Viola 1 Espressive f
490	Viola 1 Detache p Up
491	Viola 1 Detache p Dw
492	Viola 1 Balzato p
493	Viola 1 Balzato mf
494	Viola 1 Sforzato
495	Viola 1 Staccato
496	Viola 1 Tremolo
497	Viola 1 Pizzicato

#	Multisample
498	Viola 2 Vibrato p
499	Viola 2 Vibrato f
500	Viola GM
501	Cello Vibrato
502	Cello GM
503	Violin & Cello
504	Cello & Contrabass
505	Contrabass Vibrato
506	Strings Quartet
507	Strings Quartet Vibrato1
508	Strings Quartet Vibrato2
509	Pizzicato
510	Strings Ens Legato1
511	Strings Ens Legato2
512	Strings Ens Legato3
513	Strings Ens Marcato
514	Strings Ens Spiccato
515	Strings Ens Staccato1
516	Strings Ens Staccato2
517	Strings Ens Tremolo
518	Strings Ens Pizzicato
519	Strings Ensemble St
520	Strings Ensemble GM
521	Strings Ensemble Mono
522	Strings Ensemble Tremolo
523	Pizzicato Ensemble
524	Harp Stereo
525	Harp Atk
526	Harp Mono
527	Ac.Gtr T 1
528	Ac.Gtr T 2
529	Ac.Gtr T 3
530	Ac.Gtr T 4
531	Ac.Gtr T 5

#	Multisample
532	Ac.Gtr T 6
533	Ac.Gtr T Ghost
534	Ac.Gtr T Mute 1
535	Ac.Gtr T Mute 2
536	Ac.Gtr T Mute 3
537	Ac.Gtr T Harmonics 1
538	Ac.Gtr T Harmonics 2
539	Ac.Gtr T HTone Up 1
540	Ac.Gtr T HTone Up 2
541	Ac.Gtr M 1
542	Ac.Gtr M 2
543	Ac.Gtr M 3
544	Ac.Gtr M Mute 1
545	Ac.Gtr M Mute 2
546	Ac.Gtr M Harmonics
547	Ac.Gtr M HTone Up 1
548	Ac.Gtr M HTone Up 2
549	Ac.Gtr RX noises
550	Ac.Gtr finger off
551	Steel Gtr 1 Pick p
552	Steel Gtr 1 Pick mf
553	Steel Gtr 1 Pick f
554	Steel Gtr 1 Mute
555	Steel Gtr 1 Slide
556	Steel Gtr 2 p
557	Steel Gtr 2 mf
558	Steel Gtr 2 f
559	Steel Gtr 2 Slap
560	Steel Gtr 2 Slide
561	Steel Gtr 12 Strings
562	Steel Gtr Harmonics 1
563	Steel Gtr Harmonics 2
564	Steel Gtr Noise
565	Guitar Fret Noise Off

#	Multisample
566	Guitar Noise Off
567	Guitar Body
568	Guitar Noise Attack Off
569	Nylon Gtr1 p
570	Nylon Gtr1 mf1
571	Nylon Gtr1 mf2
572	Nylon Gtr1 mf3
573	Nylon Gtr1 f
574	Nylon Gtr1 Slide p
575	Nylon Gtr1 Slide f
576	Nylon Gtr1 Harmonics
577	Nylon Gtr2 p
578	Nylon Gtr2 mf
579	Nylon Gtr2 f
580	Nylon Gtr2 Atk
581	Nylon Gtr2 GM
582	Nylon Gtr 7 Strings p
583	Nylon Gtr 7 Strings f
584	Nylon Gtr 7 Strings Mute
585	FS N Dw Clean 1
586	FS N Dw Clean 2
587	FS N Dw Clean 3
588	FS N Dw Clean 4
589	FS N Ghost Clean
590	FS N Mute Clean 1
591	FS N Mute Clean 2
592	FS N Mute Clean 3
593	FS N Mute Clean 4
594	FS N Mute Clean 5
595	FS N Dw DI 1
596	FS N Dw DI 2
597	FS N Dw DI 3
598	FS N Dw DI 4
599	FS N Dw DI 5

#	Multisample
600	FS N Dw DI 6
601	FS N Ghost DI
602	FS N Mute DI 1
603	FS N Mute DI 2
604	FS N Mute DI 3
605	FS N Mute DI 4
606	FS N Mute DI 5
607	FS B Dw Overdrive 1
608	FS B Dw Overdrive 2
609	FS B Dw Overdrive 3
610	FS B Mute Overdrive 1
611	FS B Mute Overdrive 2
612	FS B Mute Overdrive 3
613	FS B RX Noise Clean 1
614	FS B RX Noise Clean 2
615	FS B RX Noise Clean 3
616	FS B Dw DI 1
617	FS B Dw DI 2
618	FS B Dw DI 3
619	FS B Dw DI 4
620	FS B Dw DI 5
621	FS B Dw DI 6
622	FS B Mute DI 1
623	FS B Mute DI 2
624	FS B Mute DI 3
625	FS B Mute DI 4
626	FS B Mute DI 5
627	FS RX Noise DI 1
628	FS RX Noise DI 2
629	FS RX Noise DI 3
630	FS Amp Noise Floor
631	Tele M Dw Clean 1
632	Tele M Dw Clean 2
633	Tele M Dw Clean 3

#	Multisample
634	Tele M Dw Clean 4
635	Tele M Mute Clean 1
636	Tele M Mute Clean 2
637	Tele M Mute Clean 3
638	Tele M Mute Clean 4
639	Tele M Mute Clean 5
640	Tele M RX Noise Clean 1
641	Tele M RX Noise Clean 2
642	Tele M RX Noise Clean 3
643	Tele M Dw DI 1
644	Tele M Dw DI 2
645	Tele M Dw DI 3
646	Tele M Dw DI 4
647	Tele M Dw DI 5
648	Tele M Dw DI 6
649	Tele M Mute DI 1
650	Tele M Mute DI 2
651	Tele M Mute DI 3
652	Tele M Mute DI 4
653	Tele M Mute DI 5
654	Tele M RX Noise DI 1
655	Tele M RX Noise DI 2
656	Tele M RX Noise DI 3
657	GLP M Dw Clean 1
658	GLP M Dw Clean 2
659	GLP M Dw Clean 3
660	GLP M Dw Clean 4
661	GLP M Mute Clean 1
662	GLP M Mute Clean 2
663	GLP M Mute Clean 3
664	GLP M Mute Clean 4
665	GLP M Mute Clean 5
666	GLP M RX Noise Clean 1
667	GLP M RX Noise Clean 2

#	Multisample
668	GLP M RX Noise Clean 3
669	GLP M Dw DI 1
670	GLP M Dw DI 2
671	GLP M Dw DI 3
672	GLP M Dw DI 4
673	GLP M Dw DI 5
674	GLP M Dw DI 6
675	GLP M Mute DI 1
676	GLP M Mute DI 2
677	GLP M Mute DI 3
678	GLP M Mute DI 4
679	GLP M Mute DI 5
680	GLP RX Noise DI 1
681	GLP RX Noise DI 2
682	GLP RX Noise DI 3
683	G335 B Dw Dist 1
684	G335 B Dw Dist 2
685	G335 B Dw Dist 3
686	G335 B Ghost Dist
687	G335 B Mute Dw Dist 1
688	G335 B Mute Dw Dist 2
689	G335 B Mute Dw Dist 3
690	G335 B Mute Dw Dist 4
691	G335 B Mute Dw Dist 5
692	G335 B RX Dist 1
693	G335 B RX Dist 2
694	G335 B RX Dist 3
695	G335 B Dw DI 1
696	G335 B Dw DI 2
697	G335 B Dw DI 3
698	G335 B Dw DI 4
699	G335 B Dw DI 5
700	G335 B Dw DI 6
701	G335 B Ghost DI

#	Multisample
702	G335 B Mute DI 1
703	G335 B Mute DI 2
704	G335 B Mute DI 3
705	G335 B Mute DI 4
706	G335 B Mute DI 5
707	G335 B RX Noise DI 1
708	G335 B RX Noise DI 2
709	G335 B RX Noise DI 3
710	Dist Guitar MP 1
711	Dist Guitar MP 2
712	Dist Guitar MP 3
713	Dist Guitar MP 4
714	Dist Guitar MP 5
715	Dist Guitar MP Slides
716	Dist Guitar MP KeyOff
717	Stra P2 MtS1
718	Stra P2 MtS2
719	Stra P2 MtS3
720	Stra P2 MtS4
721	Stra P2 MtS5
722	Stra P2 MtS6
723	Stra P2 MtL1
724	Stra P2 MtL2
725	Stra P2 MtL3
726	Stra P2 MtL4
727	Stra P2 Dw1
728	Stra P2 Dw2
729	Stra P2 Dw3
730	Stra P2 Dw4
731	Stra P2 Dw5
732	Stra P2 Up1
733	Stra P2 Up2
734	Stra P2 Up3
735	Stra P2 Up4

#	Multisample
736	Stra P2 Up5
737	Stra P2 SlideHT p
738	Stra P2 SlideHT f
739	Stra P2 Harm 12
740	Stra P2 Harm 7
741	Stra P2 Harm 5
742	Stra P2 Ghost Up
743	Stra P2 Ghost Dw
744	Stra P2 Fret Nuances
745	Stra P2 Key Off
746	Stra RX1 (Old Compatib)
747	Stra RX2
748	El.Guitar Stra 54 p
749	El.Guitar Stra 54 mf
750	El.Guitar Stra 54 f
751	El.Guitar Stra 54 Slide
752	El.Guitar Tel Mid p
753	El.Guitar Tel Mid mf
754	El.Guitar Tel Mid f
755	El.Guitar Tel Bridge p
756	El.Guitar Tel Bridge mf
757	El.Guitar Tel Bridge f
758	El.Guitar Tel Mt 5th pp
759	El.Guitar Tel Mt 5th p
760	El.Guitar Tel Mt 5th mf
761	El.Guitar Tel Mt 5th f
762	El.Guitar Tel Mt 5th ff
763	El.Guitar Tel Mt 5th Kof
764	El.Guitar Clean Str p
765	El.Guitar Clean Str f
766	El.Guitar Clean Mute
767	El.Guitar Clean Dead
768	El.Guitar Clean Slap
769	El.Guitar Clean Slide

#	Multisample
770	El.Guitar Clean GM
771	El.Guitar Fret Noise GM
772	El.Guitar Cut Noise GM
773	El.Guitar Le Neck
774	El.Guitar Le Bridge
775	El.Guitar Le Mute p
776	El.Guitar Le Mute mf
777	El.Guitar Le Ghost1
778	El.Guitar Le Ghost2
779	El.Guitar Harmonics
780	El.Guitar Gliss Down
781	El.Guitar Gliss Up
782	El.Guitar Noise
783	El.Guitar Short Noise
784	El.Guitar Fret Noise
785	El.Guitar Les P.
786	Jazz Guitar1
787	Jazz Guitar2
788	Jazz Gib mellow p
789	Jazz Gib mellow mf
790	Jazz Gib mellow f
791	Jazz Octave Guitar
792	Pedal Steel Guitar
793	Resonator Guitar
794	Vox Wah Guitar
795	Overdrive GM
796	Dist.Guitar1
797	Dist.Guitar1 GM
798	Dist.Guitar1 Harm.
799	Dist.Guitar1 Harm. GM
800	Dist.Guitar2 Harmo P1
801	Dist.Guitar2 Harmo P2
802	Dist.Guitar2 Mute1
803	Dist.Guitar2 Mute2

#	Multisample
804	El.Guitar DistMuted 1
805	El.Guitar DistMuted 2
806	El.Guitar PowerChord1
807	El.Guitar PowerChord2
808	El.Guitar PowerChord3
809	Ac.Bass Natural
810	Ac.Bass Natural Key Off
811	Ac.Bass Natural Ghost
812	Acoustic Bass1
813	Acoustic Bass2 mf
814	Acoustic Bass2 f
815	Acoustic Bass3 mp
816	Acoustic Bass3 mp VAR
817	Acoustic Bass3 mf
818	Acoustic Bass3 mf VAR
819	Acoustic Bass3 f
820	Acoustic Bass3 f VAR
821	Acoustic Bass GM
822	Acoustic Bass RX Noises
823	Bass SR Finger 1
824	Bass SR Finger 2
825	Bass SR Finger 3
826	Bass SR Ghost1
827	Bass SR Ghost2
828	Bass SR Ghost3
829	Bass SR Ghost4
830	Bass SR Finger Mute 1
831	Bass SR Finger Mute 2
832	Bass SR Finger Mute 3
833	Bass SR Pick1
834	Bass SR Pick2
835	Bass SR Pick3
836	Bass SR Pick4
837	Bass SR Pick Mute 1

#	Multisample
838	Bass SR Pick Mute 2
839	Bass SR Pick Mute 3
840	Bass SR Harmonics
841	Bass SR Note Off
842	Bass SR Thumb&Slap 1
843	Bass SR Thumb&Slap 2
844	Bass SR Slide UD
845	Bass SR Slide Down
846	Bass SR Hammer On
847	JB Finger 1
848	JB Finger 2
849	JB Finger 3
850	JB Finger 4
851	JB Finger 5
852	JB Ghost
853	JB Finger Mute 1
854	JB Finger Mute 2
855	JB Finger Mute 3
856	JB Pick 1
857	JB Pick 2
858	JB Pick 3
859	JB Pick 4
860	JB Pick Mute 1
861	JB Pick Mute 2
862	JB Pick Mute 3
863	JB Thumb 1
864	JB Thumb 2
865	JB Slap 1
866	JB Slap 2
867	JB Slap Ghost
868	JB Harmonics
869	PB FS Finger 1
870	PB FS Finger 2
871	PB FS Finger 3

#	Multisample
872	PB FS Finger 4
873	PB FS Ghost
874	PB FS Fing Mute 1
875	PB FS Fing Mute 2
876	PB FS Fing Mute 3
877	PB FS Pick 1
878	PB FS Pick 2
879	PB FS Pick 3
880	PB FS Pick 4
881	PB FS Pick Mute 1
882	PB FS Pick Mute 2
883	PB FS Pick Mute 3
884	PB FS Pick Mute 4
885	PB FS Harmonics
886	PB Finger 1
887	PB Finger 2
888	PB Finger 3
889	PB Finger 4
890	PB Finger 5
891	FJB Fretless Finger 1
892	FJB Fretless Finger 2
893	FJB Fretless Finger 3
894	FJB Fretless Finger 4
895	FJB Fretless Vibrato
896	FJB Fretless Harm 1
897	FJB Fretless Harm 2
898	FJB Fretless Hammer On
899	FJB Fretless KeyOff
900	Bass Prec FS Finger
901	Bass Prec Finger
902	Bass Prec FingerDeads
903	Bass Prec Pick Open p
904	Bass Prec Pick Open f
905	Bass Prec Pick Dead

#	Multisample
906	Bass Sray Finger
907	Bass Sray Harmonics
908	Bass Sray Deads
909	Bass Sray HandNoise
910	Bass Almb Fingered p
911	Bass Almb Fingered f
912	Bass Fjazz Fingered
913	Bass Fjazz pickmute p
914	Bass Fjazz pickmute f
915	Bass Fjazz Ghost
916	E.Bass1 Finger
917	E.Bass2 P.B.1
918	E.Bass2 P.B.2
919	E.Bass2 LH Stop
920	E.Bass2 RH Stop
921	E.Bass2 Harmo.
922	E.Bass3 p
923	E.Bass3 mf
924	E.Bass3 f Slap
925	E.Bass4 Pick
926	E.Bass4 Harmo.
927	E.Bass4 Slap
928	E.Bass4 SlapHar
929	E.Bass4 LH Mute
930	E.Bass4 RH Mute
931	E.Bass5 Finger
932	E.Bass6 Finger
933	E.Bass6 FingerLP
934	E.Bass7 Finger
935	E.Bass8 Pick
936	E.Bass9 Pick Muted1
937	E.Bass9 Pick Muted2
938	E.Bass9 Pick
939	E.Bass9 PickLP

#	Multisample
940	E.Bass10 Thumb
941	E.Bass11 SlapThumb
942	E.Bass11 SlapThumbLP
943	E.Bass Gliss
944	E.Bass Noise1
945	E.Bass Noise2
946	E.Bass Harmonics
947	E.Bass HarmonicsLP
948	E.Bass Fretless 1
949	E.Bass Fretless 2
950	Finger Bass GM
951	Picked Bass GM
952	Slap Bass 1 GM
953	Slap Bass 2 GM
954	Fretless Bass GM
955	Sitar 1
956	Sitar 2
957	Sitar GM
958	Sitar & Tambura
959	Zither
960	Santur
961	SanturLP
962	Tambura
963	TamburalP
964	Bouzouki
965	BouzoukiLP
966	Mandolin Dw mf
967	Mandolin Dw f
968	Mandolin Up
969	Mandolin mono
970	Mandolin monoLP
971	Mandolin Tremolo
972	Mandolin Ensemble
973	Viola Caipira p

#	Multisample
974	Viola Caipira mf
975	Viola Caipira f
976	Viola Caipira Mute
977	Viola Caipira Harmonics
978	Viola Caipira Noises
979	Bandolim
980	Berimbau Op Q 1
981	Berimbau Op Q 2
982	Berimbau Op Q 3
983	Berimbau Op Q 4
984	Berimbau Op A 1
985	Berimbau Op A 2
986	Berimbau Op A 3
987	Berimbau Op A Rel 1
988	Berimbau Op A Rel 2
989	Berimbau Op A Rel 3
990	Berimbau Cax atk p
991	Berimbau Cax atk f
992	Berimbau Cax rel p
993	Berimbau Cax rel f
994	Berimbau Crash Leg p
995	Berimbau Crash Leg f
996	Berimbau Crash p
997	Berimbau Crash f
998	Banjo1 Finger Op 1
999	Banjo1 Finger Op 2
1000	Banjo1 Finger Op 3
1001	Banjo1 Finger Op 4
1002	Banjo1 Finger Op 5
1003	Banjo1 Finger Op 6
1004	Banjo1 Thumb Op 1
1005	Banjo1 Thumb Op 2
1006	Banjo1 Thumb Op 3
1007	Banjo1 Thumb Op 4

#	Multisample
1008	Banjo1 Thumb Op 5
1009	Banjo1 Thumb Op 6
1010	Banjo1 Ghost
1011	Banjo1 Mute 1
1012	Banjo1 Mute 2
1013	Banjo1 Mute 3
1014	Banjo1 Harmonics
1015	Banjo1 Mordente
1016	Banjo2
1017	Banjo GM
1018	BanjoLP
1019	Banjo RX Noise
1020	Dobro Thumb 1
1021	Dobro Thumb 2
1022	Dobro Thumb 3
1023	Dobro Thumb 4
1024	Dobro Thumb 5
1025	Dobro Thumb 6
1026	Dobro Ghost
1027	Dobro Muted 1
1028	Dobro Muted 2
1029	Dobro Muted 3
1030	Dobro Rake Blues
1031	Dobro Vibrato
1032	Dobro Slide Vibrato
1033	Dobro Harmonics
1034	Dobro Pick Noise
1035	Cavaquino p
1036	Cavaquino mf
1037	Cavaquino f
1038	Ukulele
1039	Shamisen
1040	Shamisen GM
1041	Koto

#	Multisample
1042	Koto GM
1043	M.E. Oud
1044	M.E. Oud Tek
1045	M.E. Kanoun1
1046	M.E. Kanoun2
1047	M.E. Kanoun Tremolo
1048	M.E. Baglama1
1049	M.E. Baglama2
1050	M.E. Zurna
1051	M.E. Klarnet Tek
1052	M.E. Klarnet
1053	M.E. Nay
1054	Mouth Harp1
1055	Mouth Harp2
1056	Mouth Harp3
1057	Mouth Harp4
1058	Mouth Harp5
1059	Syn Flute Pad
1060	Synth Sub Bass
1061	Syn Bass Reso
1062	Syn Bass FM1
1063	Syn Bass FM1LP
1064	Syn Bass FM2
1065	Syn Bass FM2LP
1066	Syn Bass TB
1067	R&B Saw Bass
1068	R&B Square Bass
1069	MS20 Bass Wave
1070	MS20 Synth
1071	SEM Square
1072	Chrom Res
1073	Compulsynth
1074	Monst Classic
1075	Monst Distort

#	Multisample
1076	Next Dance
1077	Fat Synth LG
1078	Detuned Super
1079	Detuned PWM
1080	Polysix Unison L
1081	Polysix Unison R
1082	Synth Brass
1083	Pop Synth
1084	An.Strings1
1085	An.Strings2
1086	Vintage Synth Pad
1087	Vintage Analog
1088	Food Blender
1089	White Pad
1090	N1 Air Vox
1091	SynthBell
1092	Ether Bell
1093	Ether BellLP
1094	Lore
1095	Lore NT
1096	Space Lore
1097	Wave Sweep1
1098	Wave Sweep2
1099	Wave Sweep3
1100	Syn Ghostly
1101	Ghost
1102	Syn Air Pad
1103	Dream Str
1104	Syn AirVortex
1105	Syn Palawan
1106	Syn Clicker
1107	Cricket Spectrum
1108	Noise1
1109	Noise2

#	Multisample
1110	Noise Pad
1111	Swish Terra
1112	Gamelan XEQ
1113	Saw1
1114	Saw2
1115	Saw3
1116	Pulse 02%
1117	Pulse 05%
1118	Pulse 08%
1119	Pulse 16%
1120	Pulse 33%
1121	Pulse 40%
1122	Square
1123	Square MG
1124	Square JP
1125	Triangle MG
1126	Ramp
1127	Ramp MG
1128	Sine
1129	DWGS Syn Sine1
1130	DWGS Syn Sine2
1131	DWGS Organ1
1132	DWGS Organ2
1133	DWGS Bell1
1134	DWGS Bell2
1135	DWGS Bell3
1136	DWGS Bell4
1137	DWGS Clav.
1138	DWGS Digi1
1139	DWGS Digi2
1140	DWGS Wire1
1141	DWGS Wire2
1142	DWGS Sync1
1143	DWGS Sync2

#	Multisample
1144	DWGS Sync3
1145	Orchestra Hit 1
1146	Orchestra Hit 2
1147	Orchestra Hit GM
1148	Band Hit
1149	Impact Hit
1150	Brass Fall
1151	Vibe Chord
1152	Zap1
1153	Zap2
1154	Stadium
1155	Applause
1156	Birds1
1157	Birds2
1158	Crickets
1159	Church Bell
1160	Thunder
1161	Stream
1162	Bubble
1163	Dog
1164	Gallop
1165	Laughing
1166	Telephone Ring
1167	Scream
1168	Punch
1169	Heart Beat
1170	Footstep 1
1171	Footstep2
1172	Door Creak
1173	Door Slam
1174	Car Engine
1175	Car EngineLP
1176	Car Stop
1177	Car Pass

#	Multisample
1178	Car Crash
1179	Train
1180	Helicopter
1181	Gun Shot
1182	Machine Gun
1183	Laser Gun
1184	Explosion
1185	Wind
1186	Chinese Gong
1187	Crash
1188	Crash Reverse
1189	Crash Reverse GM
1190	Orchestra Crash
1191	Ride Jazz
1192	Ride Edge1
1193	Ride Edge2
1194	HiHat Closed
1195	88 HiHat Open
1196	88 Cowbell
1197	88 Tom
1198	88 Conga
1199	88 Crash
1200	Tom
1201	Tom Brush
1202	Tom Process
1203	Electric Tom
1204	Melodic Tom GM
1205	Flexatone
1206	Tambourine
1207	Agogo Bell
1208	Meditation Tree
1209	Marc Tree
1210	Marc TreeLP
1211	Rain Stick

#	Multisample
1212	Cowbell
1213	Castanet
1214	Temple Blocks
1215	Orchestra BD
1216	Timpani
1217	Taiko
1218	Djembe Open
1219	Djembe Mute
1220	Conga
1221	Quinto & Bongo
1222	Okonkolo
1223	Timbales
1224	Cowbell & Clave
1225	Cabasa
1226	Shaker
1227	Cabasa & Shaker
1228	Dumbek - Djambe - Udu
1229	Caxixi
1230	Tabla & Baya
1231	WoodBlock & Castanet
1232	Mix Latin Percussion
1233	Kangaroo
1234	DJ Eddie Set
1235	Bob Slice A
1236	Bob Slice B
1237	Claps Natural Set1
1238	Claps Natural Set2
1239	Claps Natural Set3
1240	Snare Ghost
1241	Stereo Snares1&2
1242	Stereo Snare1
1243	Stereo Snare2
1244	BD Thunder Bright

#	Multisample
1245	FX SD Large Hall1
1246	FX SD Large Hall2
1247	FX Rim Large Hall1
1248	FX Rim Large Hall2
1249	Click
1250	Metronome W bell
1251	Metronome W
1252	Empty
1253	IT G.Piano V1
1254	IT G.Piano V2
1255	IT G.Piano V3
1256	IT G.Piano V4
1257	IT G.Piano V5
1258	IT G.Piano V6
1259	IT G.Piano Res V1
1260	IT G.Piano Res V2
1261	IT G.Piano Res V3
1262	IT G.Piano Res V4
1263	IT G.Piano Res V5
1264	IT G.Piano Res V6
1265	Posaune 32 OT
1266	Principal OT
1267	Cornet OT
1268	Coppel Flute OT
1269	Harmonic Trumpet OT
1270	Viola da Gamba OT
1271	Mixture A OT
1272	Mixture B OT
1273	Pieno OT
1274	Recorder Vibrato
1275	Whistle Robin
1276	Tenor Sax J Soft
1277	Tenor Sax J mp

#	Multisample
1278	Tenor Sax J mf
1279	Tenor Sax J f
1280	Tenor Sax J Growl
1281	Tenor Sax J R-Up
1282	Tenor Sax J R-Dw
1283	Tenor Sax J Falls
1284	IT Accordion Bass V1 OT
1285	IT Accordion Bass V2 OT
1286	IT Accordion Bass V3 OT
1287	IT Accordion Bass Key On
1288	IT Accordion 16 V1 OT
1289	IT Accordion 16 V2 OT
1290	IT Accordion 16 V3 OT
1291	IT Accordion 16 V4 OT
1292	IT Accordion 8 V1 OT
1293	IT Accordion 8 V2 OT
1294	IT Accordion 8 V3 OT
1295	IT Accordion 8 V4 OT
1296	IT Accordion 4 V1 OT
1297	IT Accordion 4 V2 OT
1298	IT Accordion 4 V3 OT
1299	IT Accordion 4 V4 OT
1300	IT Accordion Noise Floor
1301	Bandoneon
1302	Bandoneon Stop
1303	Bandoneon Short
1304	Bandoneon Valve
1305	Bandoneon RX
1306	Ac. Guitar T410
1307	Ac. Guitar T410 Muted
1308	Ac. Guitar T410 Harm
1309	Ac. Guitar T410 RX
1310	J8 Analog Brass L

#	Multisample
1311	J8 Analog Brass R
1312	Dumpstep Wha
1313	Dumpstep Lp
1314	Dumpstep One Shot
1315	END Pa Compatibility
1316	AT G.Piano Main1
1317	AT G.Piano Main2
1318	AT G.Piano Main3
1319	AT G.Piano Main4
1320	AT G.Piano Main5
1321	AT G.Piano Main6
1322	AT G.Piano Main7
1323	AT G.Piano Main8
1324	AT G.Piano Reso1
1325	AT G.Piano Reso2
1326	AT G.Piano Reso3
1327	AT G.Piano Reso4
1328	AT G.Piano Reso5
1329	AT G.Piano Reso6
1330	AT G.Piano Reso7
1331	AT G.Piano Reso8
1332	AT G.Piano Release 1
1333	AT G.Piano Release 2
1334	AT G.Piano Mech.Noise
1335	AT G.Piano Hammer Noise
1336	AT G.Piano OverTones
1337	Y CFIII SA Main 1
1338	Y CFIII SA Main 2
1339	Y CFIII SA Main 3
1340	Y CFIII SA Main 4
1341	Y CFIII SA Main 5
1342	Y CFIII SA Main 6
1343	Y CFIII SA Main 7

#	Multisample
1344	Y CFIII SA Main 8
1345	Y CFIII SA Reso 1
1346	Y CFIII SA Reso 2
1347	Y CFIII SA Reso 3
1348	Y CFIII SA Reso 4
1349	Y CFIII SA Reso 5
1350	Y CFIII SA Reso 6
1351	Y CFIII SA Reso 7
1352	Y CFIII SA Reso 8
1353	U3 Main 1
1354	U3 Main 2
1355	U3 Main 3
1356	U3 Main 4
1357	U3 Main 5
1358	U3 Main 6
1359	U3 Main 7
1360	U3 Main 8
1361	U3 Reso 1
1362	U3 Reso 2
1363	U3 Reso 3
1364	U3 Reso 4
1365	U3 Reso 5
1366	U3 Reso 6
1367	U3 Reso 7
1368	U3 Reso 8
1369	U3 Release 1
1370	U3 Release 2
1371	U3 Mech.Noise
1372	Honky Real
1373	RdMkII Line ppp
1374	RdMkII Line pp
1375	RdMkII Line p
1376	RdMkII Line mp
1377	RdMkII Line mf

#	Multisample
1378	RdMkII Line f
1379	RdMkII Line ff
1380	RdMkII Line fff
1381	RdMkII C414 ppp
1382	RdMkII C414 pp
1383	RdMkII C414 p
1384	RdMkII C414 mp
1385	RdMkII C414 mf
1386	RdMkII C414 f
1387	RdMkII C414 ff
1388	RdMkII C414 fff
1389	RdMkII KeyON Line
1390	RdMkII KeyON C414
1391	RdMkII KOF slow Line
1392	RdMkII KOF slow C414
1393	RdMkII KOF fast Line
1394	RdMkII KOF fast C414
1395	RdMk V pp
1396	RdMk V p
1397	RdMk V mp
1398	RdMk V mp+
1399	RdMk V mf
1400	RdMk V mf+
1401	RdMk V f
1402	RdMk V ff
1403	RdMk V Ground Noise
1404	RdMk V Noise Floor
1405	W 200A Mic ppp
1406	W 200A Mic pp
1407	W 200A Mic p
1408	W 200A Mic mp
1409	W 200A Mic mf
1410	W 200A Mic mf+
1411	W 200A Mic f

#	Multisample
1412	W 200A Mic ff
1413	W 200A Mic fff
1414	W 200A Mic fff+
1415	W 200A Line ppp
1416	W 200A Line pp
1417	W 200A Line p
1418	W 200A Line mp
1419	W 200A Line mf
1420	W 200A Line f
1421	W 200A Line ff
1422	W 200A Line fff
1423	W 200A Line fff+
1424	W 200A Line Sin C7
1425	W 200A Line H&Res C7
1426	W 200A Line H&Res -C7
1427	W 200A Line H&Res --C7
1428	DX EP 1 Dyn V1
1429	DX EP 1 Dyn V2
1430	DX EP 1 Dyn V3
1431	DX EP 1 Dyn V4
1432	DX EP 1 Dyn V5
1433	DX EP 1 Dyn V6
1434	DX EP 2 Dyn V1
1435	DX EP 2 Dyn V2
1436	DX EP 2 Dyn V3
1437	DX EP 2 Dyn V4
1438	DX EP 2 Dyn V5
1439	DX EP 2 Dyn V6
1440	CP Piano Main v1
1441	CP Piano Main v2
1442	CP Piano Main v3
1443	CP Piano Main v4
1444	CP Piano Main v5
1445	CP Piano Main v6

#	Multisample
1446	CP Piano Resonance
1447	CP Piano Release v1
1448	CP Piano Release v2
1449	ClavD6 AC Main v1
1450	ClavD6 AC Main v2
1451	ClavD6 AC Main v3
1452	ClavD6 AC Main v4
1453	ClavD6 AC Main v5
1454	ClavD6 AC Main v6
1455	ClavD6 AC Main v7
1456	ClavD6 AC Main v8
1457	ClavD6 AC Off v1
1458	ClavD6 AC Off v2
1459	ClavD6 AC Off v3
1460	ClavD6 AC Off v4
1461	ClavD6 AD Main v1
1462	ClavD6 AD Main v2
1463	ClavD6 AD Main v3
1464	ClavD6 AD Main v4
1465	ClavD6 AD Main v5
1466	ClavD6 AD Main v6
1467	ClavD6 AD Main v7
1468	ClavD6 AD Main v8
1469	ClavD6 BC Main v1
1470	ClavD6 BC Main v2
1471	ClavD6 BC Main v3
1472	ClavD6 BC Main v4
1473	ClavD6 BC Main v5
1474	ClavD6 BC Main v6
1475	ClavD6 BC Main v7
1476	ClavD6 BC Main v8
1477	ClavD6 BD Main v1
1478	ClavD6 BD Main v2
1479	ClavD6 BD Main v3

#	Multisample
1480	ClavD6 BD Main v4
1481	ClavD6 BD Main v5
1482	ClavD6 BD Main v6
1483	ClavD6 BD Main v7
1484	ClavD6 BD Main v8
1485	Harpsichord Double
1486	Harpsichord Release
1487	Harpsichord Off
1488	Piano Felt mp
1489	Piano Felt f
1490	Piano Rubber
1491	Piano Eraser
1492	Piano Wood
1493	B3 Leakage All Wheels
1494	B3 Perc 2nd Slow
1495	B3 Key ON Original
1496	B3 Note OFF from 4'
1497	B3 Click from 16'
1498	Xylophone Natural
1499	Steel Drum 1 mf
1500	Steel Drum 1 f
1501	CYmbalom long p
1502	CYmbalom long f
1503	CYmbalom short p
1504	CYmbalom short mf
1505	CYmbalom short f
1506	Recorder Straight
1507	Recorder Vibrato
1508	Recorder & Voice
1509	Recorder Sforzato 5th
1510	Recorder 4Up
1511	Recorder 4Dw
1512	Recorder Tongue Atk
1513	Xaphoon Vibrato

#	Multisample
1514	Xaphoon Grace Note
1515	Xaphoon Crescendo
1516	Xaphoon Expressive
1517	Xaphoon Gliss HT
1518	Clarinet PVib p
1519	Clarinet PVib mf
1520	Clarinet PVib f
1521	Clarinet Vibrato p
1522	Clarinet Vibrato mf
1523	Clarinet Vibrato f
1524	Clarinet Gliss4 Dw mf
1525	Clarinet Gliss4 Dw f
1526	Clarinet Gliss4 Up mf
1527	Clarinet Gliss4 Up f
1528	Clarinet Gliss UP Long
1529	Clarinet Crescendo
1530	Clarinet Klez pp Exp
1531	Clarinet Klez mf Exp
1532	Clarinet Klezmer ff
1533	Clarinet Klezmer HT Up
1534	Clarinet Klezmer Falls
1535	Clarinet It Folk PVib
1536	Clarinet It Folk Vib
1537	Clarinet Falls Risata
1538	Clarinet Falls Short
1539	Clarinet Falls Long
1540	Contrabassoon
1541	Bassoon
1542	Bagpipe Bass
1543	Bagpipe Straight
1544	BB B Sax PVib pp
1545	BB B Sax PVib p
1546	BB B Sax PVib mf
1547	BB B Sax PVib f

#	Multisample
1548	BB B Sax Vib p
1549	BB B Sax Vib mf
1550	BB B Sax Vib f
1551	BB B Sax Grace mf
1552	BB B Sax Grace f
1553	BB B Sax Crescendo
1554	BB B Sax Glis4 Dw mf
1555	BB B Sax Glis4 Dw f
1556	BB B Sax Glis4 Up mf
1557	BB B Sax Glis4 Up f
1558	BB B Sax Glis 8 Dw
1559	BB B Sax Glis 8 Up
1560	BB T Sax PVib p
1561	BB T Sax PVib mf
1562	BB T Sax PVib f
1563	BB T Sax Crescendo
1564	BB T Sax 4UP mf
1565	BB T Sax 4UP f
1566	BB T Sax 4DW mf
1567	BB T Sax 4DW f
1568	BB T Sax 8UP mf
1569	BB T Sax 8UP f
1570	BB T Sax 8DW mf
1571	BB T Sax 8DW f
1572	BB T Sax Falls
1573	BB A Sax PVib p
1574	BB A Sax PVib mf
1575	BB A Sax PVib f
1576	BB A Sax Vib p
1577	BB A Sax Vib mf
1578	BB A Sax Vib f
1579	BB A Sax Grace mf
1580	BB A Sax Grace f
1581	BB A Sax Crescendo

#	Multisample
1582	BB A Sax Portamento Up
1583	BB A Sax Gliss 4Up mf
1584	BB A Sax Gliss 4Up f
1585	BB A Sax Gliss 8Up mf
1586	BB A Sax Gliss 8Up f
1587	BB A Sax Gliss 4Dw mf
1588	BB A Sax Gliss 4Dw f
1589	BB A Sax Gliss 8Dw mf
1590	BB A Sax Gliss 8Dw f
1591	BB A Sax Falls Short
1592	BB A Sax Falls Long
1593	BB S Sax PVib p
1594	BB S Sax PVib mf
1595	BB S Sax PVib f
1596	BB S Sax Vib p
1597	BB S Sax Vib mf
1598	BB S Sax Vib f
1599	BB S Sax Grace mf
1600	BB S Sax Grace f
1601	BB S Sax Crescendo
1602	BB S Sax 4 Up mf
1603	BB S Sax 4 Up f
1604	BB S Sax 8 Up mf
1605	BB S Sax 8 Up f
1606	BB S Sax 4 Dw mf
1607	BB S Sax 4 Dw f
1608	BB S Sax 8 Dw mf
1609	BB S Sax 8 Dw f
1610	BB S Sax Falls Shrt
1611	BB S Sax Falls Long
1612	Sousaphone mf
1613	Sousaphone f
1614	Sousaphone Staccato mf
1615	Sousaphone Staccato f

#	Multisample
1616	Sousaphone FX
1617	BB Trmb PVib p
1618	BB Trmb PVib mf
1619	BB Trmb PVib f
1620	BB Trmb Port Up4
1621	BB Trmb Port Dw4
1622	BB Trmb Doit
1623	BB Trmb Crescendo Long
1624	BB Trmb Crescendo Shrt
1625	BB Trmb Sforzato
1626	BB Trmb Staccato p
1627	BB Trmb Staccato mf
1628	BB Trmb Staccato f
1629	BB Trmb Grace mf
1630	BB Trmb Grace f
1631	BB Trumpet PVib p
1632	BB Trumpet PVib mf
1633	BB Trumpet PVib f
1634	BB Trumpet PVib ff
1635	BB Trumpet PVib fff
1636	BB Trumpet Up4
1637	BB Trumpet Dw4
1638	BB Trumpet Doit
1639	BB Trumpet Cresc Long
1640	BB Trumpet Cresc Short
1641	BB Trumpet Falls Long
1642	BB Trumpet Falls Short
1643	BB Trumpet Mex PVib
1644	BB Trumpet Mex
1645	BB Trumpet Up8
1646	BB Trumpet Dw8
1647	BB Trumpet Shakes
1648	BB Trumpet Cup p
1649	BB Trumpet Cup mf

#	Multisample
1650	BB Trp HandWha Growl
1651	BB Trp Plung Wah p
1652	BB Trp Plung Wah mf
1653	BB Trp Plung Wah Growl
1654	BB Trp Harm
1655	BB Trp Harm Wha
1656	BB Trp Harm Wha Growl
1657	BB Trp Lips Atk
1658	BB Trp Noise Atk
1659	BB Trp Sus Breath
1660	CBass PVib mf
1661	CBass PVib f
1662	CBass Vib p
1663	CBass Vib mf
1664	CBass Vib f
1665	CBass Balzato Up
1666	CBass Balzato Dw
1667	CBass Spiccato Up
1668	CBass Spiccato Dw
1669	CBass Marcato Up
1670	CBass Marcato Dw
1671	CBass Pizzicato p
1672	CBass Pizzicato mf
1673	CBass Tremolo
1674	CBass Up4
1675	CBass DW4
1676	CBass Release
1677	CBass Arch Noise
1678	Cello PVib mf
1679	Cello PVib f
1680	Cello Vib mf1
1681	Cello Vib mf2
1682	Cello Vib mf3
1683	Cello Balzato Up

#	Multisample
1684	Cello Balzato Dw
1685	Cello Spiccato Up
1686	Cello Spiccato Dw
1687	Cello Marcato Up
1688	Cello Marcato Dw
1689	Cello Piz mf Vib
1690	Cello Piz f Vib
1691	Cello Tremolo
1692	Cello Up4
1693	Cello Dw4
1694	Cello Up8
1695	Cello Dw8
1696	Cello Chords
1697	Cello Res Only CGDA
1698	Cello Vib End
1699	Cello Play End
1700	Cello Atk Noise
1701	Cello Atk Noise Loop
1702	Viola PVib mf
1703	Viola PVib f
1704	Viola Vib p
1705	Viola vib mf
1706	Viola Vib f
1707	Viola Balzato Up
1708	Viola Balzato Dw
1709	Viola Spiccato Up
1710	Viola Spiccato Dw
1711	Viola Marcato Up
1712	Viola Marcato Dw
1713	Viola Pizzicato mf
1714	Viola Pizzicato f
1715	Viola Tremolo
1716	Viola Port Up4
1717	Viola Port Dw4

#	Multisample
1718	Viola Port Up8
1719	Viola Port Dw8
1720	Viola Maj Up8
1721	Viola Maj Dw8
1722	Viola Chords
1723	Viola Passionate Up
1724	Viola Passionate Dw
1725	Violin PVib mf
1726	Violin PVib f
1727	Violin Vib mf
1728	Violin Vib f
1729	Violin Balzato Up
1730	Violin Balzato Dw
1731	Violin Spiccato Up
1732	Violin Spiccato Dw
1733	Violin Marcato Up
1734	Violin Marcato Dw
1735	Violin Pizz mf
1736	Violin Pizz f
1737	Violin Tremolo
1738	Violin Port Up4
1739	Violin Port Dw4
1740	Violin Port Up8
1741	Violin Port Dw8
1742	Violin Scale Up8
1743	Violin Scale Dw8
1744	Violin Full Chords
1745	Violin End mf
1746	Violin End f
1747	Violin Res Only GDAE
1748	Arch Noise Multi
1749	Arch Noise Only 1
1750	Arch Atk Noise Long
1751	Arch Atk Noise Short

#	Multisample
1752	Violin "S" Vibrato
1753	Violin "A" Vibrato
1754	E.Gt.L P1DI Harmonics
1755	E.Gt.L P1DI Mute WS1
1756	E.Gt.L P1DI Mute WS2
1757	E.Gt.L P1DI Mute WS3
1758	E.Gt.L P1DI Mute WS4
1759	E.Gt.L P1DI OST RR1
1760	E.Gt.L P1DI OST RR2
1761	E.Gt.L P1DI OST RR3
1762	E.Gt.L P1DI OST RR4
1763	E.Gt.L P1DI PowerChd RR1
1764	E.Gt.L P1DI PowerChd RR2
1765	E.Gt.L P1DI PowerChd RR3
1766	E.Gt.L P1DI PowerChd RR4
1767	E.Gt.S P1DI OST WS1
1768	E.Gt.S P1DI OST WS2
1769	E.Gt.S P1DI OST WS3
1770	E.Gt.S P1DI OST WS4
1771	E.Gt.S P1DI OST WS5
1772	E.Gt.S P1DI OST WS6
1773	E.Gt.S P1DI OST WS7
1774	E.Gt.S P1DI OST WS8
1775	E.Gt.S P1DI OST WS9
1776	E.Gt.S P4DI Mute WS1
1777	E.Gt.S P4DI Mute WS2
1778	E.Gt.S P4DI Mute WS3
1779	E.Gt.S P4DI Mute WS4
1780	E.Gt.S P4DI Open WS1
1781	E.Gt.S P4DI Open WS2
1782	E.Gt.S P4DI Open WS3
1783	E.Gt.S P4DI Open WS4
1784	E.Gt.S P4DI OST WS1
1785	E.Gt.S P4DI OST WS2

#	Multisample
1786	E.Gt.S P4DI OST WS3
1787	E.Gt.S P4DI OST WS4
1788	E.Gt.S P4DI OST WS5
1789	E.Gt.S P4DI OST WS6
1790	E.Gt.S P4DI OST WS7
1791	E.Gt.S P4DI OST WS8
1792	HB finger1
1793	HB finger2
1794	HB finger3
1795	HB finger4
1796	HB finger5
1797	HB finger6
1798	HB Fing Ghost
1799	HB Fing Muted S p
1800	HB Fing Muted S mf
1801	HB Fing Muted L p
1802	HB Fing Muted L mf
1803	HB Pick 1
1804	HB Pick 2
1805	HB Pick 3
1806	HB Pick 4
1807	HB Pick 5
1808	HB Pick Ghost
1809	HB Pick Muted1
1810	HB Pick Muted2
1811	HB Pick Muted3
1812	HB Finger Off
1813	HB Harmonics Hi
1814	HB Harmonics Low Noise
1815	MM D 1 Triangle
1816	MM D 2 T Sawtooth Osc1-2
1817	MM D 2 Rev Sawtooth Osc3
1818	MM D 3 Sawtooth
1819	MM D 4 Rectangle

#	Multisample
1820	MM D 5 Wide Pulse
1821	MM D 6 Narrow Pulse
1822	MM D White Noise
1823	MM D Pink Noise
1824	MM D Noise Atk
1825	MB LBrute Tri
1826	MB SBrute Saw
1827	MB LBrute Square
1828	MB Metallizer Tri
1829	MB Noise Mod Saw1
1830	MB Noise Mod Saw2
1831	MB Noise Mod Squ1
1832	MB Noise Mod Squ2
1833	Arp2600 Square
1834	Arp2600 Saw
1835	Arp2600 Triangle
1836	Arp2600 Sine
1837	Arp2600 White Noise
1838	Arp2600 Pink Noise
1839	Arp2600 LoFreq Noise
1840	Arp2600 3 Unison Saw
1841	Arp2600 OctUniSqu
1842	Arp2600 XModSaw
1843	Arp2600 XModSqu
1844	Arp2600 PWM1
1845	Arp2600 PWM2
1846	ElectroBass
1847	FutureHouseBass
1848	G-HouseBass
1849	TrapBass
1850	Electro Saw
1851	EDM Super Saw
1852	Future Bass Saw1
1853	Future Bass Saw2

#	Multisample
1854	Super Square
1855	Super Triangle
1856	Sylen Brite Pad1
1857	Sylen Brite Pad2
1858	Sylen HOV Straight
1859	Sylen Rommey Bass
1860	MG Bass
1861	Syn Bass Disco MG
1862	Syn Bass Rommey
1863	MS2000 Unison Saw
1864	Brite Pad
1865	Brite Hoover
1866	Ultra Square
1867	Ultra Triangle
1868	Future Bass Pad
1869	Electro Pad
1870	Ultra Vox Pad
1871	Octave Pad
1872	Razor Olive Pad
1873	Razor Ripper
1874	Wobble Wave 1
1875	Wobble Wave 2
1876	Massive Cannon
1877	Sat Vox Wave
1878	EDM Voice Lead 1
1879	EDM Voice Lead 2
1880	EDM Voice Lead 3
1881	EDM Voice Lead 4
1882	Octave Unison Pluck
1883	MG HM Hard
1884	MG Trio
1885	Soft Layer Synth
1886	DownLow Pluck 1
1887	DownLow Pluck 2

#	Multisample
1888	Synth Marimba
1889	Reso 5th Comp
1890	Dirty Sine Pluck 1
1891	Dirty Sine Pluck 2
1892	Pingpong Dry
1893	Pingpong Wet
1894	Bubbles
1895	Flutters
1896	Little Beetles
1897	Staples
1898	Sun Strings
1899	Sweepers
1900	Triangle Lo-fi
1901	Saw Sine
1902	Saw 5th
1903	Square OctaveMix
1904	Siren Set
1905	Cinematic Impact 1
1906	Cinematic Impact 2
1907	Cinematic Impact 3
1908	Cinematic Impact 4
1909	Cinematic Impact 5
1910	Cinematic Impact 6
1911	Cinematic Impact 7
1912	Cinematic Bang 1
1913	Cinematic Bang 2
1914	Cinematic Bang 3
1915	Cinematic Bang 4
1916	Cinematic Bang 5
1917	Cinematic Bang 6
1918	Cinematic Bang 7
1919	Cinematic Bang 8
1920	Reverse Attack Set
1921	Bang Industry 1

#	Multisample
1922	Bang Industry 2
1923	Bang Metal
1924	Sci-fi Shifter Set
1925	Sci-fi Shifter 1
1926	Sci-fi Shifter 2
1927	Sci-fi Atoms
1928	Atoms Impact 1
1929	Atoms Impact 2
1930	Atmos Melody 1
1931	Atmos Melody 2
1932	Atmos Melody 3
1933	Atmos Melody 4
1934	Atmos Melody 5
1935	Atmos Melody 6
1936	Atmos Melody 7
1937	Atmos Melody 8
1938	Atmos Melody 9
1939	Atmos Melody 10
1940	Atmos Melody 11
1941	Atmos Melody 12
1942	Atmos Melody 13
1943	Atmos Melody 14
1944	Atmos Melody 15
1945	Atmos Melody 16
1946	Atmos Melody 17
1947	Atmos Melody 18
1948	Atmos Lead
1949	Atoms SEQ 1
1950	Atoms SEQ 2
1951	Atoms SEQ 3
1952	Atoms SEQ 4
1953	Atoms SEQ 5
1954	Atoms SEQ 6
1955	Harm Organ

#	Multisample
1956	Brain Core
1957	Lava Grungy
1958	Motor World
1959	Digi Boiling 1
1960	Digi Boiling 2
1961	Cave Window
1962	Darka
1963	Flying Saucer
1964	Noize Impact 1
1965	Noize Impact 2
1966	Orchestra PA Hit
1967	Blind Echo
1968	Formant Bass
1969	KBass
1970	RapBass
1971	Snap Synth
1972	Rock Falls Hit 1
1973	Rock Falls Hit 2
1974	Rock Falls Hit 3a
1975	Rock Falls Hit 3b
1976	Rock Falls Hit 4
1977	Rock Hit Short
1978	Rock Hit Long 1
1979	Rock Hit Long 2
1980	Guitar Shot
1981	Bass&Guitar Shot
1982	Down Sub 1
1983	Down Sub 2

#	Multisample
1984	Down Sub 3
1985	Talk Show Set
1986	Quiz Show Set
1987	Horror Set
1988	Invader Set
1989	Cartoon Set
1990	VideoGame Set
1991	Weather Set
1992	Water Set
1993	Jungle Set
1994	Life Set
1995	Clock Set
1996	SFX Catalog 1
1997	SFX Catalog 2
1998	SFX Catalog 3
1999	SFX Catalog 4
2000	SFX Catalog 5
2001	SFX Cinematic
2002	SFX Industry
2003	SFX Life
2004	SFX Melody & Atmosphere
2005	SFX TV & Show
2006	Click 1 Sample
2007	Click 3 Samples
2008	Click 7 Samples

* IT Accordion courtesy by [PSound](#).

Drum Samples

The following table contains all the Factory Drum Samples as they appear in the **Sound Edit** mode. **DF:** Drum Family.

#	Drum Sample	DF	#	Drum Sample	DF
0	BD Spn Sof 1 Room	BD	28	BD Grt A 5	BD
1	BD Spn Sof 2 Room	BD	29	BD Grt A 6	BD
2	BD Spn Sof 3 Room	BD	30	BD Grt A 7	BD
3	BD Spn Sof 4 Room	BD	31	BD Grt A 8	BD
4	BD Spn Sof 5 Room	BD	32	BD Grt B 1	BD
5	BD Spn Sof 6 Room	BD	33	BD Grt B 2	BD
6	BD Spn Sof 7 Room	BD	34	BD Grt B 3	BD
7	BD Spn Sof 8 Room	BD	35	BD Grt B 4	BD
8	BD Spn Son 1 Room	BD	36	BD Grt B 5	BD
9	BD Spn Son 2 Room	BD	37	BD Grt B 6	BD
10	BD Spn Son 3 Room	BD	38	BD Grt B 7	BD
11	BD Spn Son 4 Room	BD	39	BD Grt B 8	BD
12	BD Spn Son 5 Room	BD	40	BD Rock 1	BD
13	BD Spn Son 6 Room	BD	41	BD Rock 2	BD
14	BD Spn Son 7 Room	BD	42	BD Rock 3	BD
15	BD Spn Son 8 Room	BD	43	BD Rock 4	BD
16	BD DW Pop 1	BD	44	BD Rock 5	BD
17	BD DW Pop 2	BD	45	BD Rock 6	BD
18	BD DW Pop 3	BD	46	BD Rock 7	BD
19	BD DW Pop 4	BD	47	BD Rock 8	BD
20	BD DW Pop 5	BD	48	BD 1 Studio 1	BD
21	BD DW Pop 6	BD	49	BD 1 Studio 2	BD
22	BD DW Pop 7	BD	50	BD 1 Studio 3	BD
23	BD DW Pop 8	BD	51	BD 1 Studio 4	BD
24	BD Grt A 1	BD	52	BD 1 Studio 5	BD
25	BD Grt A 2	BD	53	BD 1 Studio 7	BD
26	BD Grt A 3	BD	54	BD 1 Studio 8	BD
27	BD Grt A 4	BD	55	BD 2 Studio 1	BD

#	Drum Sample	DF
56	BD 2 Studio 2	BD
57	BD 2 Studio 3	BD
58	BD 2 Studio 4	BD
59	BD 2 Studio 5	BD
60	BD 2 Studio 6	BD
61	BD 2 Studio 7	BD
62	BD 2 Studio 8	BD
63	BD Chamber 1	BD
64	BD Chamber 2	BD
65	BD Chamber 3	BD
66	BD Chamber 4	BD
67	BD Chamber 5	BD
68	BD Chamber 6	BD
69	BD Live 1	BD
70	BD Live 2	BD
71	BD Live 3	BD
72	BD Live 4	BD
73	BD Live 5	BD
74	BD Live 6	BD
75	BD Funk 1	BD
76	BD Funk 2	BD
77	BD Funk 3	BD
78	BD Funk 4	BD
79	BD Funk 5	BD
80	BD Funk 6	BD
81	BD Plate 1	BD
82	BD Plate 2	BD
83	BD Plate 3	BD
84	BD Plate 4	BD
85	BD 22 Inch Std1	BD
86	BD 22 Inch Std2	BD
87	BD 22 Inch Std3	BD
88	BD 22 Inch Std4	BD
89	BD 22 Inch Std5	BD

#	Drum Sample	DF
90	BD 22 Inch Std6	BD
91	BD 24x14 p	BD
92	BD 24x14 mf	BD
93	BD 24x14 f	BD
94	BD 24x14 f GM	BD
95	BD 24 inch Open p	BD
96	BD 24 inch Open mf	BD
97	BD 24 inch Open f	BD
98	BD 26 inch Open p	BD
99	BD 26 inch Open mf	BD
100	BD 26 inch Open f	BD
101	BD 26 inch Open ff	BD
102	BD 26 inch Open ff GM	BD
103	BD 26 inch Std p	BD
104	BD 26 inch Std mf	BD
105	BD 26 inch Std f	BD
106	BD 26 inch Std ff	BD
107	BD Natural1 p	BD
108	BD Natural1 mf	BD
109	BD Natural1 f	BD
110	BD Natural2 p	BD
111	BD Natural2 mf	BD
112	BD Natural2 f	BD
113	BD Natural2 ff	BD
114	BD Pop1	BD
115	BD Pop2	BD
116	BD Pop3 p	BD
117	BD Pop3 f	BD
118	BD Pop4 p	BD
119	BD Pop4 f	BD
120	BD Pop5	BD
121	BD Acoustic1 p	BD
122	BD Acoustic1 mf	BD
123	BD Acoustic1 f	BD

#	Drum Sample	DF
124	BD Acoustic2 mf	BD
125	BD Acoustic2 mf GM	BD
126	BD Acoustic2 f	BD
127	BD Acoustic2 f GM	BD
128	BD open p	BD
129	BD open mf	BD
130	BD open f	BD
131	BD Peak	BD
132	BD Dry1	BD
133	BD Dry2	BD
134	BD Dry3	BD
135	BD Normal	BD
136	BD SoftRoom	BD
137	BD Pillow	BD
138	BD Woofer	BD
139	BD MondoKill	BD
140	BD Terminator	BD
141	BD Tubby	BD
142	BD Gated	BD
143	BD Tight	BD
144	BD Squash	BD
145	BD Soul1	BD
146	BD Soul2	BD
147	BD Soul3 dist	BD
148	BD Soul4 noise	BD
149	BD Soul5 Long	BD
150	BD Soul6	BD
151	BD Jazz OP1	BD
152	BD Jazz OP2	BD
153	BD Jazz OP3	BD
154	BD Jazz OP4	BD
155	BD Jazz OP5	BD
156	BD Jazz OP6	BD
157	BD Jazz OP7	BD

#	Drum Sample	DF
158	BD Jazz OP8	BD
159	BD Jazz OPW1	BD
160	BD Jazz OPW2	BD
161	BD Jazz OPW3	BD
162	BD Jazz OPW4	BD
163	BD Jazz OPW5	BD
164	BD Jazz OPW6	BD
165	BD Jazz OPW7	BD
166	BD Jazz OPW8	BD
167	BD Jazz Hi 1	BD
168	BD Jazz Hi 2	BD
169	BD Jazz Hi 3	BD
170	BD Jazz Hi 4	BD
171	BD Jazz Hi 5	BD
172	BD Jazz Hi 6	BD
173	BD Jazz Hi 7	BD
174	BD Jazz Hi 8	BD
175	BD Jazz Low 1	BD
176	BD Jazz Low 2	BD
177	BD Jazz Low 3	BD
178	BD Jazz Low 4	BD
179	BD Jazz Low 5	BD
180	BD Jazz Low 6	BD
181	BD Jazz Low 7	BD
182	BD Jazz Low 8	BD
183	BD Jazz open p	BD
184	BD Jazz open f	BD
185	BD Jazz wire open p	BD
186	BD Jazz wire open f	BD
187	BD Jazz	BD
188	BD Jazz GM	BD
189	BD async 1	BD
190	BD async 2	BD
191	BD async 3	BD

#	Drum Sample	DF
192	BD async 4	BD
193	BD Satur 1	BD
194	BD Satur 2	BD
195	BD Satur 3	BD
196	BD Elektro	BD
197	BD HipHop1	BD
198	BD HipHop2	BD
199	BD IDM 1	BD
200	BD IDM 2	BD
201	BD Tribal 1	BD
202	BD Tribal 2	BD
203	BD Thunder bright	BD
204	BD Thunder dark	BD
205	BD Analog	BD
206	BD MS20 A 1	BD
207	BD MS20 A 2	BD
208	BD MS20 A 3	BD
209	BD MS20 A 4	BD
210	BD MS20 A 5	BD
211	BD MS20 A 6	BD
212	BD MS20 B 1	BD
213	BD MS20 B 2	BD
214	BD MS20 B 3	BD
215	BD MS20 C 1	BD
216	BD MS20 C 2	BD
217	BD MS20 C 3	BD
218	BD MS20 D	BD
219	BD MS20 Gliss Down	BD
220	BD ET Down	BD
221	BD ET DubStep 1	BD
222	BD ET DubStep 2	BD
223	BD ET DubStep 3	BD
224	BD ET HipHop 1	BD
225	BD ET HipHop 2	BD

#	Drum Sample	DF
226	BD ET HipHop 3	BD
227	BD ET House A 1	BD
228	BD ET House A 2	BD
229	BD ET House A 3	BD
230	BD ET House B 1	BD
231	BD ET House B 2	BD
232	BD ET House B 3	BD
233	BD ET Gliss Up 1	BD
234	BD ET Gliss Up 2	BD
235	BD ET Gliss Up 3	BD
236	BD ET Minimal A 1	BD
237	BD ET Minimal A 2	BD
238	BD ET Minimal A 3	BD
239	BD ET Minimal B 1	BD
240	BD ET Minimal B 2	BD
241	BD ET Minimal B 3	BD
242	BD Dance1	BD
243	BD Dance2	BD
244	BD Dance3	BD
245	BD House1	BD
246	BD House2	BD
247	BD House3	BD
248	BD House4	BD
249	BD House5	BD
250	BD Liquid	BD
251	BD Techno1	BD
252	BD Techno2	BD
253	BD Hip1	BD
254	BD Hip2	BD
255	BD Hip3	BD
256	BD Hip4	BD
257	BD Kick1	BD
258	BD Kick2	BD
259	BD Electro	BD

#	Drum Sample	DF
260	BD Ambient	BD
261	BD Ambient Crackle	BD
262	BD Ambient Rocker	BD
263	BD Pop	BD
264	BD Deep	BD
265	BD Deep GM	BD
266	BD Klanger	BD
267	BD Electribe01	BD
268	BD Electribe02	BD
269	BD Electribe03	BD
270	BD Electribe04	BD
271	BD Electribe05	BD
272	BD Electribe06	BD
273	BD Electribe07	BD
274	BD Electribe08	BD
275	BD Electribe09	BD
276	BD Electribe10	BD
277	BD Electribe11	BD
278	BD Electribe12	BD
279	BD Electribe13	BD
280	BD Electribe14	BD
281	BD Electribe15	BD
282	BD Electribe16	BD
283	BD Electribe17	BD
284	BD Syn1	BD
285	BD Syn2	BD
286	BD Syn3	BD
287	BD Syn4	BD
288	BD Buzz	BD
289	BD Orchestra Open p	BD
290	BD Orchestra Open f	BD
291	BD Orchestra muted	BD
292	BD Orchestra	BD
293	BD Orchestra GM	BD

#	Drum Sample	DF
294	Timpani	BD
295	SD DW Pop 1	SD
296	SD DW Pop 2	SD
297	SD DW Pop 3	SD
298	SD DW Pop 4	SD
299	SD DW Pop 5	SD
300	SD DW Pop 6	SD
301	SD DW Pop 7	SD
302	SD DW Pop 8	SD
303	SD Brady 1	SD
304	SD Brady 2	SD
305	SD Brady 3	SD
306	SD Brady 4	SD
307	SD Brady 5	SD
308	SD Brady 6	SD
309	SD Brady 7	SD
310	SD Brady 8	SD
311	SD Ldw A 1	SD
312	SD Ldw A 2	SD
313	SD Ldw A 3	SD
314	SD Ldw A 4	SD
315	SD Ldw A 5	SD
316	SD Ldw A 6	SD
317	SD Ldw A 7	SD
318	SD Ldw A 8	SD
319	SD Ldw B 1	SD
320	SD Ldw B 2	SD
321	SD Ldw B 3	SD
322	SD Ldw B 4	SD
323	SD Ldw B 5	SD
324	SD Ldw B 6	SD
325	SD Ldw B 7	SD
326	SD Ldw B 8	SD
327	SD Alc A 1	SD

#	Drum Sample	DF
328	SD Alc A 2	SD
329	SD Alc A 3	SD
330	SD Alc A 4	SD
331	SD Alc A 5	SD
332	SD Alc A 6	SD
333	SD Alc A 7	SD
334	SD Alc A 8	SD
336	SD Alc B 2	SD
337	SD Alc B 3	SD
338	SD Alc B 4	SD
339	SD Alc B 5	SD
340	SD Alc B 6	SD
341	SD Alc B 7	SD
342	SD Alc B 8	SD
343	SD Rock A 1	SD
344	SD Rock A 2	SD
345	SD Rock A 3	SD
346	SD Rock A 4	SD
347	SD Rock A 5	SD
348	SD Rock A 6	SD
349	SD Rock A 7	SD
350	SD Rock A 8	SD
351	SD Rock B 1	SD
352	SD Rock B 2	SD
353	SD Rock B 3	SD
354	SD Rock B 4	SD
355	SD Rock B 5	SD
356	SD Rock B 6	SD
357	SD Rock B 7	SD
358	SD Rock B 8	SD
359	SD D1 1	SD
360	SD D1 2	SD
361	SD D1 3	SD
362	SD D1 4	SD

#	Drum Sample	DF
363	SD D1 5	SD
364	SD D1 6	SD
365	SD D2 1	SD
366	SD D2 2	SD
367	SD D2 3	SD
368	SD D2 4	SD
369	SD D2 5	SD
370	SD D2 6	SD
371	SD P1 1	SD
372	SD P1 2	SD
373	SD P1 3	SD
374	SD P1 4	SD
375	SD P1 5	SD
376	SD P1 6	SD
377	SD P2 1	SD
378	SD P2 2	SD
379	SD P2 3	SD
380	SD P2 4	SD
381	SD P2 5	SD
382	SD P2 6	SD
383	SD S1 1	SD
384	SD S1 2	SD
385	SD S1 3	SD
386	SD S1 4	SD
387	SD S1 5	SD
388	SD S1 6	SD
389	SD S2 1	SD
390	SD S2 2	SD
391	SD S2 3	SD
392	SD S2 4	SD
393	SD S2 5	SD
394	SD S2 6	SD
395	SD Y1 1	SD
396	SD Y1 2	SD

#	Drum Sample	DF
397	SD Y1 3	SD
398	SD Y1 4	SD
399	SD Y1 5	SD
400	SD Y1 6	SD
401	SD Y2 1	SD
402	SD Y2 2	SD
403	SD Y2 3	SD
404	SD Y2 4	SD
405	SD Y2 5	SD
406	SD Y2 6	SD
407	SD Plate 1	SD
408	SD Plate 2	SD
409	SD Plate Ghost	SD
410	SD Plate Rim	SD
411	SD 1 Studio 1	SD
412	SD 1 Studio 2	SD
413	SD 1 Studio 3	SD
414	SD 1 Studio 4	SD
415	SD 1 Studio 5	SD
416	SD 1 Studio 6	SD
417	SD 1 Studio 7	SD
418	SD 1 Studio 8	SD
419	SD 2 Studio 1	SD
420	SD 2 Studio 2	SD
421	SD 2 Studio 3	SD
422	SD 2 Studio 4	SD
423	SD 2 Studio 5	SD
424	SD 2 Studio 6	SD
425	SD 2 Studio 7	SD
426	SD 2 Studio 8	SD
427	SD Crv p	SD
428	SD Crv mf	SD
429	SD Crv f	SD
430	SD Crv+Rim p	SD

#	Drum Sample	DF
431	SD Crv+Rim mf	SD
432	SD Crv+Rim f	SD
433	SD CrvOpen pp	SD
434	SD CrvOpen p	SD
435	SD CrvOpen mf	SD
436	SD CrvOpen f	SD
437	SD CrvOpRim pp	SD
438	SD CrvOpRim p	SD
439	SD CrvOpRim mf	SD
440	SD CrvOpRim f	SD
441	SD Crv Roll p	SD
442	SD Crv Roll mf	SD
443	SD Crv Roll f	SD
444	SD Crv Stage p	SD
445	SD Crv Stage mf	SD
446	SD Crv Stage f	SD
447	SD Crv+Rim Stage p	SD
448	SD Crv+Rim Stage mf	SD
449	SD Crv+Rim Stage f	SD
450	SD Crv Open Stage pp	SD
451	SD Crv Open Stage p	SD
452	SD Crv Open Stage mf	SD
453	SD Crv Open Stage f	SD
454	SD Crv OpRim Stage pp	SD
455	SD Crv OpRim Stage p	SD
456	SD Crv OpRim Stage mf	SD
457	SD Crv OpRim Stage f	SD
458	SD Crv Gate1 p	SD
459	SD Crv Gate1 mf	SD
460	SD Crv Gate1 f	SD
461	SD Crv+Rim Gate1 p	SD
462	SD Crv+Rim Gate1 mf	SD
463	SD Crv+Rim Gate1 f	SD
464	SD Crv OpRim Gate1 pp	SD

#	Drum Sample	DF
465	SD Crv OpRim Gate1 p	SD
466	SD Crv OpRim Gate1 mf	SD
467	SD Crv OpRim Gate1 f	SD
468	SD Crv Roll Gate1 p	SD
469	SD Crv Roll Gate1 mf	SD
470	SD Crv Roll Gate1 f	SD
471	SD Crv Gate2 p	SD
472	SD Crv Gate2 mf	SD
473	SD Crv Gate2 f	SD
474	SD Crv+Rim Gate2 p	SD
475	SD Crv+Rim Gate2 mf	SD
476	SD Crv+Rim Gate2 f	SD
477	SD Crv Roll Gate2 p	SD
478	SD Crv Roll Gate2 mf	SD
479	SD Crv Roll Gate2 f	SD
480	SD Crv+Rim Plate p	SD
481	SD Crv+Rim Plate mf	SD
482	SD Crv+Rim Plate f	SD
483	SD Crv Open Plate pp	SD
484	SD Crv Open Plate p	SD
485	SD Crv Open Plate mf	SD
486	SD Crv Open Plate f	SD
487	SD Crv OpRim Plate pp	SD
488	SD Crv OpRim Plate p	SD
489	SD Crv OpRim Plate mf	SD
490	SD Crv OpRim Plate f	SD
491	SD Crv Open Room pp	SD
492	SD Crv Open Room p	SD
493	SD Crv Open Room mf	SD
494	SD Crv Open Room f	SD
495	SD Crv OpRim Room pp	SD
496	SD Crv OpRim Room p	SD
497	SD Crv OpRim Room mf	SD
498	SD Crv OpRim Room f	SD

#	Drum Sample	DF
499	SD LdwBB1A Cl1	SD
500	SD LdwBB1A Cl2	SD
501	SD LdwBB1A Cl3	SD
502	SD LdwBB1A Cl4	SD
503	SD LdwBB1A OpRim1	SD
504	SD LdwBB1A OpRim2	SD
505	SD LdwBB1A OpRim3	SD
506	SD LdwBB1A OpRim4	SD
507	SD LdwBB1A Roll1	SD
508	SD LdwBB1A Roll2	SD
509	SD LdwBB1A Roll3	SD
510	SD LdwBB1B Op1	SD
511	SD LdwBB1B Op2	SD
512	SD LdwBB1B Op3	SD
513	SD LdwBB1B Op4	SD
514	SD LdwBB1B OpRim1	SD
515	SD LdwBB1B OpRim2	SD
516	SD LdwBB1B OpRim3	SD
517	SD LdwBB1B OpRim4	SD
518	SD LdwBB2 OpRim1	SD
519	SD LdwBB2 OpRim2	SD
520	SD LdwBB2 Std1	SD
521	SD LdwBB2 Std2	SD
522	SD LdwBB2 Std3	SD
523	SD LdwBB2 Roll1	SD
524	SD LdwBB2 Roll2	SD
525	SD LdwBB2 Roll3	SD
526	SD LdwBB2 Roll4	SD
527	SD LdwSup Std p	SD
528	SD LdwSup Std mf	SD
529	SD LdwSup Std f	SD
530	SD LdwSup Std+Rim p	SD
531	SD LdwSup Std+Rim mf	SD
532	SD LdwSup Std+Rim f	SD

#	Drum Sample	DF
533	SD LdwSup Std Gate p	SD
534	SD LdwSup Std Gate mf	SD
535	SD LdwSup Std Gate f	SD
536	SD LdwSup S+R Gate p	SD
537	SD LdwSup S+R Gate mf	SD
538	SD LdwSup S+R Gate f	SD
539	SD LdwSup Std Room p	SD
540	SD LdwSup Std Room mf	SD
541	SD LdwSup Std Room f	SD
542	SD LdwSup S+R Room p	SD
543	SD LdwSup S+R Room mf	SD
544	SD LdwSup S+R Room f	SD
545	SD LdwVintage Std p	SD
546	SD LdwVintage Std mf	SD
547	SD LdwVintage Std f	SD
548	SD LdwVintage Std ff	SD
549	SD LdwVintage S+Rim p	SD
550	SD LdwVintage S+Rim mf	SD
551	SD LdwVintage S+Rim f	SD
552	SD Ldw Roll p	SD
553	SD Ldw Roll mf	SD
554	SD Ldw Roll f	SD
555	SD LdwVint Room p	SD
556	SD LdwVint Room mf	SD
557	SD LdwVint Room f	SD
558	SD LdwVint Room ff	SD
559	SD LdwVint room S+R p	SD
560	SD LdwVint room S+R mf	SD
561	SD LdwVint room S+R f	SD
562	SD Ldw Roll room p	SD
563	SD Ldw Roll room mf	SD
564	SD Ldw Roll room f	SD
565	SD Spr Std p	SD
566	SD Spr Std mf	SD

#	Drum Sample	DF
567	SD Spr Std f	SD
568	SD Spr StdRim p	SD
569	SD Spr StdRim mf	SD
570	SD Spr StdRim f	SD
571	SD Spr Open p	SD
572	SD Spr Open mf	SD
573	SD Spr Open f	SD
574	SD Spr Open ff	SD
575	SD Spr OpRim p	SD
576	SD Spr OpRim mf	SD
577	SD Spr OpRim f	SD
578	SD Spr OpRim ff	SD
579	SD Spr Roll p	SD
580	SD Spr Roll mf	SD
581	SD P.E. Std p	SD
582	SD P.E. Std mf	SD
583	SD P.E. Std f	SD
584	SD P.E. Std+Rim p	SD
585	SD P.E. Std+Rim mf	SD
586	SD P.E. Std+Rim f	SD
587	SD P.E. Open p	SD
588	SD P.E. Open mf	SD
589	SD P.E. Open f	SD
590	SD P.E. OpRim mf	SD
591	SD P.E. OpRim f	SD
592	SD P.E. Roll mf	SD
593	SD P.E. Roll f	SD
594	SD Natural p	SD
595	SD Natural mf	SD
596	SD Natural f	SD
597	SD Natural Rim p	SD
598	SD Natural Rim mf	SD
599	SD Natural Rim f	SD
600	SD Dry center1	SD

#	Drum Sample	DF
601	SD Dry center2	SD
602	SD Dry center3	SD
603	SD Dry Rim1	SD
604	SD Dry Rim2	SD
605	SD Dry Rim3	SD
606	SD Dry Roll	SD
607	SD Pop1 p	SD
608	SD Pop1 p GM	SD
609	SD Pop1 mf	SD
610	SD Pop1 mf GM	SD
611	SD Pop1 f	SD
612	SD Pop1 f GM	SD
613	SD Pop1 +Rim mf	SD
614	SD Pop1 +Rim mf GM	SD
615	SD Pop1 +Rim f	SD
616	SD Pop1 +Rim f GM	SD
617	SD Pop2 p	SD
618	SD Pop2 mf	SD
619	SD Pop2 f	SD
620	SD Pop2 ff	SD
621	SD Flam	SD
622	SD Black	SD
623	SD S Gate1	SD
624	SD S Gate1 GM	SD
625	SD S Gate2	SD
626	SD S Gate3	SD
627	SD Wood1 p	SD
628	SD Wood1 mf	SD
629	SD Wood1 f	SD
630	SD Wood2 pp	SD
631	SD Wood2 p	SD
632	SD Wood2 mf	SD
633	SD Wood2 f	SD
634	SD Piccolo1 pp	SD

#	Drum Sample	DF
635	SD Piccolo1 p	SD
636	SD Piccolo1 mf	SD
637	SD Piccolo1 f	SD
638	SD Piccolo2 pp	SD
639	SD Piccolo2 p	SD
640	SD Piccolo2 mf	SD
641	SD Piccolo2 f	SD
642	SD Solid1 p	SD
643	SD Solid1 mf	SD
644	SD Solid1 f	SD
645	SD Solid2 p	SD
646	SD Solid2 mf	SD
647	SD Solid2 f	SD
648	SD Maple1 pp	SD
649	SD Maple1 p	SD
650	SD Maple1 mp	SD
651	SD Maple1 mf	SD
652	SD Maple1 f	SD
653	SD Maple1 ff	SD
654	SD Maple2 pp	SD
655	SD Maple2 p	SD
656	SD Maple2 mp	SD
657	SD Maple2 mf	SD
658	SD Maple2 f	SD
659	SD Maple2 ff	SD
660	SD Brass1 p	SD
661	SD Brass1 mf	SD
662	SD Brass1 f	SD
663	SD Brass2 p	SD
664	SD Brass2 mf	SD
665	SD Brass2 f	SD
666	SD Roll	SD
667	SD Ghost Roll	SD
668	SD Ghost p	SD

#	Drum Sample	DF
669	SD Ghost f	SD
670	SD Snr Ghost1 a	SD
671	SD Snr Ghost1 b	SD
672	SD Snr Ghost2 a	SD
673	SD Snr Ghost2 b	SD
674	SD Snr Ghost2 c	SD
675	SD Snr Signature p	SD
676	SD Snr Signature mf	SD
677	SD Snr Signature f	SD
678	SD Snr Signature Rim mf	SD
679	SD Snr Signature Rim f	SD
680	SD Snr Signature Rim1	SD
681	SD Snr Signature Rim2	SD
682	SD Dry1	SD
683	SD Dry2	SD
684	SD Dry3	SD
685	SD Full Room	SD
686	SD Off Center	SD
687	SD Jazz Ring	SD
688	SD J center p	SD
689	SD J center f	SD
690	SD J edge1	SD
691	SD J edge2	SD
692	SD J edge3	SD
693	SD J edge4	SD
694	SD J std p	SD
695	SD J std mf	SD
696	SD J std f	SD
697	SD J std+rim p	SD
698	SD J std+rim mf	SD
699	SD J std+rim f	SD
700	SD Amb.Piccolo	SD
701	SD Paper	SD
702	SD Big Rock	SD

#	Drum Sample	DF
703	SD Yowie	SD
704	SD Trinity1	SD
705	SD Trinity2	SD
706	SD Stereo Gate	SD
707	SD Stereo Gate GM	SD
708	SD Processed	SD
709	SD Processed GM	SD
710	SD Processed + AMB	SD
711	SD Cracker Room	SD
712	SD El. Funk1	SD
713	SD El. Funk2	SD
714	SD El. Funk3	SD
715	SD Dance01	SD
716	SD Dance02	SD
717	SD Dance03	SD
718	SD Dance04	SD
719	SD Dance05	SD
720	SD Dance06	SD
721	SD Dance07	SD
722	SD Dance08	SD
723	SD Dance09	SD
724	SD Dance10	SD
725	SD Dance11	SD
726	SD Dance12	SD
727	SD Dance13	SD
728	SD Dance14	SD
729	SD Dance15	SD
730	SD Dance16	SD
731	SD Dance17	SD
732	SD Dance18	SD
733	SD Dance19	SD
734	SD Dance20	SD
735	SD Dance21	SD
736	SD Dance22	SD

#	Drum Sample	DF
737	SD Dance23	SD
738	SD Dance23 GM	SD
739	SD Dance24	SD
740	SD House1	SD
741	SD House2	SD
742	SD House3	SD
743	SD House4	SD
744	SD BeatBox	SD
745	SD Small	SD
746	SD Rap	SD
747	SD Noise	SD
748	SD Reverse	SD
749	SD Hip1	SD
750	SD Hip2	SD
751	SD Hip3	SD
752	SD Hip4	SD
753	SD Hip5	SD
754	SD Hip6	SD
755	SD Ringy	SD
756	SD Tiny	SD
757	SD Vintage1	SD
758	SD Vintage2	SD
759	SD Vintage3	SD
760	SD Vintage4	SD
761	SD Vintage5	SD
762	SD Vintage6	SD
763	SD AmbiHop	SD
764	SD Brasser	SD
765	SD Chili	SD
766	SD Whopper	SD
767	SD Syn.1	SD
768	SD Syn.2	SD
769	SD Syn.3	SD
770	SD Syn.4	SD

#	Drum Sample	DF
771	SD Electro	SD
772	SD ET DubStep1_0	SD
773	SD ET DubStep1_1	SD
774	SD ET DubStep1_2	SD
775	SD Orchestra	SD
776	SD Orch. Roll	SD
777	SD Brush C1	SD
778	SD Brush C2	SD
779	SD Brush C3	SD
780	SD Brush C4	SD
781	SD Brush C5	SD
782	SD Brush C6	SD
783	SD Brush Mute1	SD
784	SD Brush Mute2	SD
785	SD Brush Mute3	SD
786	SD Brush Mute4	SD
787	SD Brush Mute5	SD
788	SD Brush Mute6	SD
789	SD Brush S1 1	SD
790	SD Brush S1 2	SD
791	SD Brush S1 3	SD
792	SD Brush S1 4	SD
793	SD Brush S1 5	SD
794	SD Brush S1 6	SD
795	SD Brush S2 1	SD
796	SD Brush S2 2	SD
797	SD Brush S2 3	SD
798	SD Brush S2 4	SD
799	SD Brush S2 5	SD
800	SD Brush S2 6	SD
801	SD Swirl A1	SD
802	SD Swirl A2	SD
803	SD Swirl A3	SD
804	SD Swirl A4	SD

#	Drum Sample	DF
805	SD Swirl B1	SD
806	SD Swirl B2	SD
807	SD Swirl B3	SD
808	SD Swirl B4	SD
809	SD Swirl C1	SD
810	SD Swirl C2	SD
811	SD Swirl C3	SD
812	SD Swirl C4	SD
813	SD Swirl L1	SD
814	SD Swirl L2	SD
815	SD Swirl L3	SD
816	SD Swirl M1	SD
817	SD Swirl M2	SD
818	SD Swirl M3	SD
819	SD Swirl S1	SD
820	SD Swirl S2	SD
821	SD Swirl S3	SD
822	SDTap&Swirl L1	SD
823	SDTap&Swirl L2	SD
824	SDTap&Swirl L3	SD
825	SDTap&Swirl L4	SD
826	SDTap&Swirl L5	SD
827	SDTap&Swirl L6	SD
828	SDTap&Swirl S1	SD
829	SDTap&Swirl S2	SD
830	SDTap&Swirl S3	SD
831	SDTap&Swirl S4	SD
832	SDTap&Swirl S5	SD
833	SDTap&Swirl S6	SD
834	SD Brush Swirl End	SD
835	SD Brush Swirl End Up	SD
836	SD Swirl GM	SD
837	SD JBrush Loop1	SD
838	SD JBrush loop2	SD

#	Drum Sample	DF
839	SD JBrush mid	SD
840	SD JBrush open p	SD
841	SD JBrush open mf	SD
842	SD JBrush open f	SD
843	SD JBrush short	SD
844	SD JBrush shot p	SD
845	SD BrushHit1	SD
846	SD BrushHit2	SD
847	SD JazzBrush1	SD
848	SD JazzBrush2	SD
849	SD Brush1 (swirl1)	SD
850	SD Brush1 (swirl2)	SD
851	SD Brush1 (swirl3)	SD
852	SD Brush1 (swirl4)	SD
853	SD Brush1	SD
854	SD Brush2 (ghost1)	SD
855	SD Brush2 (ghost2)	SD
856	SD Brush2 (ghost3)	SD
857	SD Brush2	SD
858	SD Brush2 (fill) 4 shots	SD
859	SD Brush2 (fill) 3 shots	SD
860	SD Brush2 (fill) 2 shots	SD
861	SD Brush3 Hit	SD
862	SD Brush3 Tap1	SD
863	SD Brush3 Tap2	SD
864	SD Brush3 Swirl	SD
865	SD FX Large Hall1	SD
866	SD FX Large Hall2	SD
867	Rim Pop 1	SD
868	Rim Pop 2	SD
869	Rim Pop 3	SD
870	Rim Pop 4	SD
871	Rim Pop 5	SD
872	Rim Pop 6	SD

#	Drum Sample	DF
873	Rim Pop 7	SD
874	Rim Pop 8	SD
875	Rim1 m Room	SD
876	Rim2 m Room	SD
877	Rim3 m Room	SD
878	Rim4 m Room	SD
879	Rim1 st Room	SD
880	Rim2 st Room	SD
881	Rim3 st Room	SD
882	Rim4 st Room	SD
883	Rim1 m rev 80's	SD
884	Rim2 m rev 80's	SD
885	Rim3 m rev 80's	SD
886	Rim4 m rev 80's	SD
887	Rim1 st rev 80's	SD
888	Rim2 st rev 80's	SD
889	Rim3 st rev 80's	SD
890	Rim4 st rev 80's	SD
891	Rim1 m Gate 1	SD
892	Rim2 m Gate 1	SD
893	Rim3 m Gate 1	SD
894	Rim4 m Gate 1	SD
895	Rim1 st Gate 1	SD
896	Rim2 st Gate 1	SD
897	Rim3 st Gate 1	SD
898	Rim4 st Gate 1	SD
899	Rim1 m Gate 2	SD
900	Rim2 m Gate 2	SD
901	Rim3 m Gate 2	SD
902	Rim4 m Gate 2	SD
903	Rim1 st Gate 2	SD
904	Rim2 st Gate 2	SD
905	Rim3 st Gate 2	SD
906	Rim4 st Gate 2	SD

#	Drum Sample	DF
907	Rim1 m Hall	SD
908	Rim2 m Hall	SD
909	Rim3 m Hall	SD
910	Rim4 m Hall	SD
911	Rim1 st Hall	SD
912	Rim2 st Hall	SD
913	Rim3 st Hall	SD
914	Rim4 st Hall	SD
915	Rim1 Amb	SD
916	Rim2 Amb	SD
917	Rim3 Amb	SD
918	Rim4 Amb	SD
919	Rim Signature Hi	SD
920	Rim Signature Mid	SD
921	Rim Signature Low	SD
922	Rim Shot p	SD
923	Rim Shot f	SD
924	Rim House1	SD
925	Rim House2	SD
926	Rim Synth	SD
927	Rim Synth Click	SD
928	Rim Synth Tamb	SD
929	Rim Analog	SD
930	Rim FX Large Hall1	SD
931	Rim FX Large Hall2	SD
932	Sidestick mf	SD
933	Sidestick f	SD
934	Sidestick Dance	SD
935	SideStick Dry	SD
936	SideStick Amb	SD
937	DrumStick Hit	SD
938	DrumStick Hit GM	SD
939	DrumStick Hit Amb	SD
940	Tom Pop Hi 1	TM

#	Drum Sample	DF
941	Tom Pop Hi 2	TM
942	Tom Pop Hi 3	TM
943	Tom Pop Hi 4	TM
944	Tom Pop Hi 5	TM
945	Tom Pop Hi 6	TM
946	Tom Pop Hi 7	TM
947	Tom Pop Hi 8	TM
948	Tom Pop Hi Mid 1	TM
949	Tom Pop Hi Mid 2	TM
950	Tom Pop Hi Mid 3	TM
951	Tom Pop Hi Mid 4	TM
952	Tom Pop Hi Mid 5	TM
953	Tom Pop Hi Mid 6	TM
954	Tom Pop Hi Mid 7	TM
955	Tom Pop Hi Mid 8	TM
956	Tom Pop Low Mid 1	TM
957	Tom Pop Low Mid 2	TM
958	Tom Pop Low Mid 3	TM
959	Tom Pop Low Mid 4	TM
960	Tom Pop Low Mid 5	TM
961	Tom Pop Low Mid 6	TM
962	Tom Pop Low Mid 7	TM
963	Tom Pop Low Mid 8	TM
964	Tom Pop Low 1	TM
965	Tom Pop Low 2	TM
966	Tom Pop Low 3	TM
967	Tom Pop Low 4	TM
968	Tom Pop Low 5	TM
969	Tom Pop Low 6	TM
970	Tom Pop Low 7	TM
971	Tom Pop Low 8	TM
972	Tom Pop Floor Hi 1	TM
973	Tom Pop Floor Hi 2	TM
974	Tom Pop Floor Hi 3	TM

#	Drum Sample	DF
975	Tom Pop Floor Hi 4	TM
976	Tom Pop Floor Hi 5	TM
977	Tom Pop Floor Hi 6	TM
978	Tom Pop Floor Hi 7	TM
979	Tom Pop Floor Hi 8	TM
980	Tom Pop Floor Low 1	TM
981	Tom Pop Floor Low 2	TM
982	Tom Pop Floor Low 3	TM
983	Tom Pop Floor Low 4	TM
984	Tom Pop Floor Low 5	TM
985	Tom Pop Floor Low 6	TM
986	Tom Pop Floor Low 7	TM
987	Tom Pop Floor Low 8	TM
988	Tom Rock Hi 1	TM
989	Tom Rock Hi 2	TM
990	Tom Rock Hi 3	TM
991	Tom Rock Hi 4	TM
992	Tom Rock Hi 5	TM
993	Tom Rock Hi 6	TM
994	Tom Rock Hi 7	TM
995	Tom Rock Hi 8	TM
996	Tom Rock Hi Mid 1	TM
997	Tom Rock Hi Mid 2	TM
998	Tom Rock Hi Mid 3	TM
999	Tom Rock Hi Mid 4	TM
1000	Tom Rock Hi Mid 5	TM
1001	Tom Rock Hi Mid 6	TM
1002	Tom Rock Hi Mid 7	TM
1003	Tom Rock Hi Mid 8	TM
1004	Tom Rock Low Mid 1	TM
1005	Tom Rock Low Mid 2	TM
1006	Tom Rock Low Mid 3	TM
1007	Tom Rock Low Mid 4	TM
1008	Tom Rock Low Mid 5	TM

#	Drum Sample	DF
1009	Tom Rock Low Mid 6	TM
1010	Tom Rock Low Mid 7	TM
1011	Tom Rock Low Mid 8	TM
1012	Tom Rock Low 1	TM
1013	Tom Rock Low 2	TM
1014	Tom Rock Low 3	TM
1015	Tom Rock Low 4	TM
1016	Tom Rock Low 5	TM
1017	Tom Rock Low 6	TM
1018	Tom Rock Low 7	TM
1019	Tom Rock Low 8	TM
1020	Tom Rock Floor Hi 1	TM
1021	Tom Rock Floor Hi 2	TM
1022	Tom Rock Floor Hi 3	TM
1023	Tom Rock Floor Hi 4	TM
1024	Tom Rock Floor Hi 5	TM
1025	Tom Rock Floor Hi 6	TM
1026	Tom Rock Floor Hi 7	TM
1027	Tom Rock Floor Hi 8	TM
1028	Tom Rock Floor Low 1	TM
1029	Tom Rock Floor Low 2	TM
1030	Tom Rock Floor Low 3	TM
1031	Tom Rock Floor Low 4	TM
1032	Tom Rock Floor Low 5	TM
1033	Tom Rock Floor Low 6	TM
1034	Tom Rock Floor Low 7	TM
1035	Tom Rock Floor Low 8	TM
1036	Tom D Hi p	TM
1037	Tom D Hi mf	TM
1038	Tom D Hi f	TM
1039	Tom D Mid p	TM
1040	Tom D Mid mf	TM
1041	Tom D Mid f	TM
1042	Tom D Low p	TM

#	Drum Sample	DF
1043	Tom D Low mf	TM
1044	Tom D Low f	TM
1045	Tom D Floor p	TM
1046	Tom D Floor mf	TM
1047	Tom D Floor f	TM
1048	Tom P Hi	TM
1049	Tom P Mid	TM
1050	Tom P Low	TM
1051	Tom P Floor	TM
1052	Tom R Vintage Hi	TM
1053	Tom R Vintage Mid	TM
1054	Tom R Vintage Floor	TM
1055	Tom Vintage Room Hi	TM
1056	Tom Vintage Room Mid	TM
1057	Tom Vintage Room Low	TM
1058	Tom1 Open Hi p	TM
1059	Tom1 Open Hi p flam	TM
1060	Tom1 Open Hi f	TM
1061	Tom1 Open Hi f flam	TM
1062	Tom1 Open Mid p	TM
1063	Tom1 Open Mid p flam	TM
1064	Tom1 Open Mid f	TM
1065	Tom1 Open Mid f flam	TM
1066	Tom1 Open Low p	TM
1067	Tom1 Open Low p flam	TM
1068	Tom1 Open Low f	TM
1069	Tom1 Open Low f flam	TM
1070	Tom1 Open Floor p	TM
1071	Tom1 Open Floor p flam	TM
1072	Tom1 Open Floor f	TM
1073	Tom1 Open Floor f flam	TM
1074	Tom2 Hi p	TM
1075	Tom2 Hi f	TM
1076	Tom2 Mid p	TM

#	Drum Sample	DF
1077	Tom2 Mid f	TM
1078	Tom2 Low p	TM
1079	Tom2 Low f	TM
1080	Tom2 Floor p	TM
1081	Tom2 Floor f	TM
1082	Tom3 Hi	TM
1083	Tom3 Floor	TM
1084	Tom4 Hi	TM
1085	Tom4 Low	TM
1086	Tom4 Floor	TM
1087	Tom5 Hi	TM
1088	Tom5 Low	TM
1089	Tom6 Vintage Hi p	TM
1090	Tom6 Vintage Hi mf	TM
1091	Tom6 Vintage Hi f	TM
1092	Tom6 Vintage Mid p	TM
1093	Tom6 Vintage Mid mf	TM
1094	Tom6 Vintage Mid f	TM
1095	Tom6 Vintage Low p	TM
1096	Tom6 Vintage Low mf	TM
1097	Tom6 Vintage Low f	TM
1098	Tom Jazz HW Hi 1	TM
1099	Tom Jazz HW Hi 2	TM
1100	Tom Jazz HW Hi 3	TM
1101	Tom Jazz HW Hi 4	TM
1102	Tom Jazz HW Hi 5	TM
1103	Tom Jazz HW Low 1	TM
1104	Tom Jazz HW Low 2	TM
1105	Tom Jazz HW Low 3	TM
1106	Tom Jazz HW Low 4	TM
1107	Tom Jazz HW Low 5	TM
1108	Tom Jazz HW Low 6	TM
1109	Tom Jazz HW Low 7	TM
1110	Tom Jazz HW Low 8	TM

#	Drum Sample	DF
1111	Tom Jazz HW Floor 1	TM
1112	Tom Jazz HW Floor 2	TM
1113	Tom Jazz HW Floor 3	TM
1114	Tom Jazz HW Floor 4	TM
1115	Tom Jazz HW Floor 5	TM
1116	Tom Jazz HW Floor 6	TM
1117	Tom Jazz HW Floor 7	TM
1118	Tom Jazz HW Floor 8	TM
1119	Tom Jazz Hi center	TM
1120	Tom Jazz Hi center GM	TM
1121	Tom Jazz Hi edge	TM
1122	Tom Jazz Hi rim	TM
1123	Tom Jazz Low center	TM
1124	Tom Jazz Low center GM	TM
1125	Tom Jazz Low edge	TM
1126	Tom Jazz Low rim	TM
1127	Tom Jazz Hi	TM
1128	Tom Jazz Floor	TM
1129	Tom Brush Mt Hi 1	TM
1130	Tom Brush Mt Hi 2	TM
1131	Tom Brush Mt Hi 3	TM
1132	Tom Brush Mt Hi 4	TM
1133	Tom Brush Mt Hi 5	TM
1134	Tom Brush Mt Hi 6	TM
1135	Tom Brush Op Hi 1	TM
1136	Tom Brush Op Hi 2	TM
1137	Tom Brush Op Hi 3	TM
1138	Tom Brush Op Hi 4	TM
1139	Tom Brush Op Hi 5	TM
1140	Tom Brush Op Hi 6	TM
1141	Tom Brush Mt Low 1	TM
1142	Tom Brush Mt Low 2	TM
1143	Tom Brush Mt Low 3	TM
1144	Tom Brush Mt Low 4	TM

#	Drum Sample	DF
1145	Tom Brush Mt Low 5	TM
1146	Tom Brush Mt Low 6	TM
1147	Tom Brush Op Low 1	TM
1148	Tom Brush Op Low 2	TM
1149	Tom Brush Op Low 3	TM
1150	Tom Brush Op Low 4	TM
1151	Tom Brush Op Low 5	TM
1152	Tom Brush Op Low 6	TM
1153	Tom Brush1 (sd open)	TM
1154	Tom Brush1 (sd close)	TM
1155	Tom Brush2 (sd open)	TM
1156	Tom Brush2 (sd close)	TM
1157	Tom Brush3 Hi mf	TM
1158	Tom Brush3 Hi f	TM
1159	Tom Brush3 Hi f GM	TM
1160	Tom Brush3 Mid mf	TM
1161	Tom Brush3 Mid f	TM
1162	Tom Brush3 Mid f GM	TM
1163	Tom Brush3 Low mf	TM
1164	Tom Brush3 Low f	TM
1165	Tom Brush3 Low f GM	TM
1166	Tom Brush4	TM
1167	Tom Brush5 Amb Hi	TM
1168	Tom Brush5 Amb Low	TM
1169	Tom Processed	TM
1170	E.Tom FM	TM
1171	E.Tom Real	TM
1172	HH Pop Z Cl 1	HH
1173	HH Pop Z Cl 2	HH
1174	HH Pop Z Cl 3	HH
1175	HH Pop Z Cl 4	HH
1176	HH Pop Z Cl 5	HH
1177	HH Pop Z Cl 6	HH
1178	HH Pop Z Cl 7	HH

#	Drum Sample	DF
1179	HH Pop Z Cl 8	HH
1180	HH Pop Z Op 1	HH
1181	HH Pop Z Op 2	HH
1182	HH Pop Z Op 3	HH
1183	HH Pop Z Op 4	HH
1184	HH Pop Z Op 5	HH
1185	HH Pop Z Op 6	HH
1186	HH Pop Z Op 7	HH
1187	HH Pop Z Op 8	HH
1188	HH Pop Z Ped 1	HH
1189	HH Pop Z Ped 2	HH
1190	HH Pop Z Ped 3	HH
1191	HH Pop Z Ped 4	HH
1192	HH Pop Z Ped 5	HH
1193	HH Pop Z Ped 6	HH
1194	HH Pop Z Ped 7	HH
1195	HH Pop Z Ped 8	HH
1196	HH Rock Cl 1	HH
1197	HH Rock Cl 2	HH
1198	HH Rock Cl 3	HH
1199	HH Rock Cl 4	HH
1200	HH Rock Cl 5	HH
1201	HH Rock Cl 6	HH
1202	HH Rock Cl 7	HH
1203	HH Rock Op 1	HH
1204	HH Rock Op 2	HH
1205	HH Rock Op 3	HH
1206	HH Rock Op 4	HH
1207	HH Rock Op 5	HH
1208	HH Rock Op 6	HH
1209	HH Rock Op 7	HH
1210	HH Rock HOp 1	HH
1211	HH Rock HOp 2	HH
1212	HH Rock HOp 3	HH

#	Drum Sample	DF
1213	HH Rock HOp 4	HH
1214	HH Rock HOp 5	HH
1215	HH Rock HOp 6	HH
1216	HH Rock HOp 7	HH
1217	HH Rock QOp 1	HH
1218	HH Rock QOp 2	HH
1219	HH Rock QOp 3	HH
1220	HH Rock QOp 4	HH
1221	HH Rock QOp 5	HH
1222	HH Rock QOp 6	HH
1223	HH Rock QOp 7	HH
1224	HH Rock Ped 1	HH
1225	HH Rock Ped 2	HH
1226	HH Rock Ped 3	HH
1227	HH Rock Ped 4	HH
1228	HH Rock Ped 5	HH
1229	HH Rock Ped 6	HH
1230	HH Rock Ped 7	HH
1231	HH Natural Cl p	HH
1232	HH Natural Cl mf	HH
1233	HH Natural Op1 p	HH
1234	HH Natural Op1 mf	HH
1235	HH Natural Op2 p	HH
1236	HH Natural Op2 mf	HH
1237	HH Natural Op3	HH
1238	HH Natural Op4	HH
1239	HH Natural pedal Cl	HH
1240	HH Natural pedal Op	HH
1241	HH Natural tip Cl p	HH
1242	HH Natural tip Cl mf	HH
1243	HH Natural tip Op1 p	HH
1244	HH Natural tip Op1 mf	HH
1245	HH Natural tip Op2 p	HH
1246	HH Natural tip Op2 mf	HH

#	Drum Sample	DF
1247	HH Natural tip Op3	HH
1248	HH Natural cup Op1	HH
1249	HH Natural cup Op2	HH
1250	HH Soul Cl p	HH
1251	HH Soul Cl mf	HH
1252	HH Soul Cl f	HH
1253	HH Soul Op p	HH
1254	HH Soul Op mf	HH
1255	HH Soul Op f	HH
1256	HH Vintage Cl p	HH
1257	HH Vintage Cl mf	HH
1258	HH Vintage Cl f	HH
1259	HH Vintage Op	HH
1260	HH Jazz Cl a	HH
1261	HH Jazz Cl b	HH
1262	HH Jazz Cl c	HH
1263	HH Jazz Op1 a	HH
1264	HH Jazz Op1 b	HH
1265	HH Jazz Op1 c	HH
1266	HH Jazz Op2 a	HH
1267	HH Jazz Op2 b	HH
1268	HH Jazz Op3	HH
1269	HH Jazz Op4	HH
1270	HH Jazz tip Cl a	HH
1271	HH Jazz tip Cl b	HH
1272	HH Jazz tip Cl c	HH
1273	HH Jazz tip Op1 a	HH
1274	HH Jazz tip Op1 b	HH
1275	HH Jazz tip Op1 c	HH
1276	HH Jazz tip Op2 a	HH
1277	HH Jazz tip Op2 b	HH
1278	HH Jazz tip Op3	HH
1279	HH Jazz ped Cl	HH
1280	HH Jazz ped Op	HH

#	Drum Sample	DF
1281	HH1 Closed pp	HH
1282	HH1 Closed p	HH
1283	HH1 Closed mf	HH
1284	HH1 Closed f	HH
1285	HH1 Open mp	HH
1286	HH1 Open mf	HH
1287	HH1 Foot mp	HH
1288	HH1 Foot mf	HH
1289	HH2 Closed pp	HH
1290	HH2 Closed p	HH
1291	HH2 Closed mp	HH
1292	HH2 Closed mf	HH
1293	HH2 Closed f	HH
1294	HH2 Closed ff	HH
1295	HH2 Open p	HH
1296	HH2 Open f	HH
1297	HH2 Foot p	HH
1298	HH2 Foot f	HH
1299	HH3 Closed1	HH
1300	HH3 Closed2	HH
1301	HH3 Open1	HH
1302	HH3 Open2	HH
1303	HH3 Sizzle	HH
1304	HH3 Foot	HH
1305	HH4 Closed1	HH
1306	HH4 Closed2	HH
1307	HH4 Open	HH
1308	HH4 Foot	HH
1309	HH4 Foot Open	HH
1310	HH Old TiteClose	HH
1311	HH Old Close1	HH
1312	HH Old Close2	HH
1313	HH Old Open1	HH
1314	HH Old Open2	HH

#	Drum Sample	DF
1315	HH Brush Nat Cl 1	HH
1316	HH Brush Nat Cl 2	HH
1317	HH Brush Nat Cl 3	HH
1318	HH Brush Nat Cl 4	HH
1319	HH Brush Nat Cl 5	HH
1320	HH Brush Nat Cl 6	HH
1321	HH Brush Nat Op a 1	HH
1322	HH Brush Nat Op a 2	HH
1323	HH Brush Nat Op a 3	HH
1324	HH Brush Nat Op a 4	HH
1325	HH Brush Nat Op a 5	HH
1326	HH Brush Nat Op a 6	HH
1327	HH Brush Nat Op b 1	HH
1328	HH Brush Nat Op b 2	HH
1329	HH Brush Nat Op b 3	HH
1330	HH Brush Nat Op b 4	HH
1331	HH Brush Nat Op b 5	HH
1332	HH Brush Nat Op b 6	HH
1333	HH Brush Nat Op c 1	HH
1334	HH Brush Nat Op c 2	HH
1335	HH Brush Nat Op c 3	HH
1336	HH Brush Nat Op c 4	HH
1337	HH Brush Nat Op c 5	HH
1338	HH Brush Nat Op c 6	HH
1339	HH Brush Nat Op d 1	HH
1340	HH Brush Nat Op d 2	HH
1341	HH Brush Nat Op d 3	HH
1342	HH Brush Nat Op d 4	HH
1343	HH Brush Nat Op d 5	HH
1344	HH Brush Nat Op d 6	HH
1345	HH Ped Nat Cl 1	HH
1346	HH Ped Nat Cl 2	HH
1347	HH Ped Nat Cl 3	HH
1348	HH Ped Nat Cl 4	HH

#	Drum Sample	DF
1349	HH Ped Nat Cl 5	HH
1350	HH Ped Nat Op 1	HH
1351	HH Ped Nat Op 2	HH
1352	HH Ped Nat Op 3	HH
1353	HH Ped Nat Op 4	HH
1354	HH Ped Nat Op 5	HH
1355	HH Brush Cl 1	HH
1356	HH Brush Cl 2	HH
1357	HH Brush Cl 3	HH
1358	HH Brush Op 1	HH
1359	HH Brush Op 2	HH
1360	HH Brush Op 3	HH
1361	HH Brush Op 4	HH
1362	HH1 MS20 Cl 1	HH
1363	HH1 MS20 Cl 2	HH
1364	HH1 MS20 Cl 3	HH
1365	HH1 MS20 Cl 4	HH
1366	HH1 MS20 Cl 5	HH
1367	HH1 MS20 Cl 6	HH
1368	HH1 MS20 Op 1	HH
1369	HH1 MS20 Op 2	HH
1370	HH1 MS20 Op 3	HH
1371	HH1 MS20 Op 4	HH
1372	HH1 MS20 Op 5	HH
1373	HH2 MS20 Cl 1	HH
1374	HH2 MS20 Cl 2	HH
1375	HH2 MS20 Cl 3	HH
1376	HH2 MS20 Cl 4	HH
1377	HH2 MS20 Cl 5	HH
1378	HH2 MS20 Cl 6	HH
1379	HH2 MS20 Op 4	HH
1380	HH2 MS20 Op 5	HH
1381	HH House Open1	HH
1382	HH House Open2	HH

#	Drum Sample	DF
1383	HH Hip	HH
1384	HH Alpo Close	HH
1385	HH Dance1	HH
1386	HH Dance2	HH
1387	HH Syn. Closed	HH
1388	HH Syn. Open	HH
1389	Ride T20 1 S 1	CY
1390	Ride T20 2 S 1	CY
1391	Ride T20 3 S 1	CY
1392	Ride T20 4 S 1	CY
1393	Ride T20 1 S 2	CY
1394	Ride T20 2 S 2	CY
1395	Ride T20 3 S 2	CY
1396	Ride T20 4 S 2	CY
1397	Ride T20 1 S 3	CY
1398	Ride T20 2 S 3	CY
1399	Ride T20 3 S 3	CY
1400	Ride T20 4 S 3	CY
1401	Ride T20 1 S 4	CY
1402	Ride T20 2 S 4	CY
1403	Ride T20 3 S 4	CY
1404	Ride T20 4 S 4	CY
1405	Ride T20 1 S 5	CY
1406	Ride T20 2 S 5	CY
1407	Ride T20 3 S 5	CY
1408	Ride T20 4 S 5	CY
1409	Ride T20 Cup 1	CY
1410	Ride T20 Cup 2	CY
1411	Ride T20 Cup 3	CY
1412	Ride T20 Cup 4	CY
1413	Ride Pop1 1	CY
1414	Ride Pop1 2	CY
1415	Ride Pop1 3	CY
1416	Ride Pop1 4	CY

#	Drum Sample	DF
1417	Ride Pop1 5	CY
1418	Ride Pop1 6	CY
1419	Ride Pop1 7	CY
1420	Ride Pop1 8	CY
1421	Ride Pop2 1	CY
1422	Ride Pop2 2	CY
1423	Ride Pop2 3	CY
1424	Ride Pop2 4	CY
1425	Ride Pop2 5	CY
1426	Ride Pop2 6	CY
1427	Ride Pop2 7	CY
1428	Ride Pop2 8	CY
1429	Ride Pop Bell 1	CY
1430	Ride Pop Bell 2	CY
1431	Ride Pop Bell 3	CY
1432	Ride Pop Bell 4	CY
1433	Ride Pop Bell 5	CY
1434	Ride Pop Bell 6	CY
1435	Ride Pop Bell 7	CY
1436	Ride Pop Bell 8	CY
1437	Ride Rock1 1	CY
1438	Ride Rock1 2	CY
1439	Ride Rock1 3	CY
1440	Ride Rock2 1	CY
1441	Ride Rock2 2	CY
1442	Ride Rock2 3	CY
1443	Ride Rock Bell 1	CY
1444	Ride Rock Bell 2	CY
1445	Ride Rock Bell 3	CY
1446	Ride Z20 edge1	CY
1447	Ride Z20 edge2	CY
1448	Ride Z20 edge3	CY
1449	Ride Z20 edge4	CY
1450	Ride Z20 edge5	CY

#	Drum Sample	DF
1451	Ride Z20 edge6	CY
1452	Ride Z20 cup1	CY
1453	Ride Z20 cup2	CY
1454	Ride Z20 cup3	CY
1455	Ride 20' mp1	CY
1456	Ride 20' mp2	CY
1457	Ride 20' mf1	CY
1458	Ride 20' mf2	CY
1459	Ride Edge1	CY
1460	Ride Edge2	CY
1461	Ride Cup	CY
1462	Ride Jazz	CY
1463	Ride Z22 Rivet 1 S1	CY
1464	Ride Z22 Rivet 2 S1	CY
1465	Ride Z22 Rivet 3 S1	CY
1466	Ride Z22 Rivet 4 S1	CY
1467	Ride Z22 Rivet 1 S2	CY
1468	Ride Z22 Rivet 2 S2	CY
1469	Ride Z22 Rivet 3 S2	CY
1470	Ride Z22 Rivet 4 S2	CY
1471	Ride Z22 Rivet 1 S3	CY
1472	Ride Z22 Rivet 2 S3	CY
1473	Ride Z22 Rivet 3 S3	CY
1474	Ride Z22 Rivet 4 S3	CY
1475	Ride Z22 Rivet Cup 1	CY
1476	Ride Z22 Rivet Cup 2	CY
1477	Ride Z22 Rivet Cup 3	CY
1478	Ride Z22 Rivet Cup 4	CY
1479	Ride Rivet	CY
1480	Ride Rivet Amb	CY
1481	Ride Brush1	CY
1482	Ride Brush2	CY
1483	Ride Brush3	CY
1484	Ride Brush Nat 11	CY

#	Drum Sample	DF
1485	Ride Brush Nat 1 2	CY
1486	Ride Brush Nat 1 3	CY
1487	Ride Brush Nat 2 1	CY
1488	Ride Brush Nat 2 2	CY
1489	Ride Brush Nat 2 3	CY
1490	Ride Brush Nat Cup 1	CY
1491	Ride Brush Nat Cup 2	CY
1492	Ride Brush Nat Cup 3	CY
1493	Ride Z Brush Edge 1	CY
1494	Ride Z Brush Edge 2	CY
1495	Ride Z Brush Cup	CY
1496	Crash Pop 1 1	CY
1497	Crash Pop 1 2	CY
1498	Crash Pop 1 3	CY
1499	Crash Pop 1 4	CY
1500	Crash Pop 1 5	CY
1501	Crash Pop 1 6	CY
1502	Crash Pop 1 7	CY
1503	Crash Pop 1 8	CY
1504	Crash Pop 2 1	CY
1505	Crash Pop 2 2	CY
1506	Crash Pop 2 3	CY
1507	Crash Pop 2 4	CY
1508	Crash Pop 2 5	CY
1509	Crash Pop 2 6	CY
1510	Crash Pop 2 7	CY
1511	Crash Pop 2 8	CY
1512	Crash Rock 1 1	CY
1513	Crash Rock 1 2	CY
1514	Crash Rock 1 3	CY
1515	Crash Rock 2 1	CY
1516	Crash Rock 2 2	CY
1517	Crash Rock 2 3	CY
1518	Crash 15' edge 1	CY

#	Drum Sample	DF
1519	Crash 15' edge 2	CY
1520	Crash 17' edge 1	CY
1521	Crash 17' edge 2	CY
1522	Crash 19' open 1	CY
1523	Crash 19' open 2	CY
1524	Crash T20 1	CY
1525	Crash T20 2	CY
1526	Crash T20 3	CY
1527	Crash T20 4	CY
1528	Crash Z 20	CY
1529	Crash 1	CY
1530	Crash 2	CY
1531	Crash Z22 Rivet 1 A1	CY
1532	Crash Z22 Rivet 2 A1	CY
1533	Crash Z22 Rivet 3 A1	CY
1534	Crash Z22 Rivet 4 A1	CY
1535	Crash Brush 1 1	CY
1536	Crash Brush 1 2	CY
1537	Crash Brush 1 3	CY
1538	Crash Brush 2 1	CY
1539	Crash Brush 2 2	CY
1540	Crash Reverse	CY
1541	Reverse CYmbal	CY
1542	Crash Dance 99	CY
1543	Crash DDD-1	CY
1544	Splash Pop 1	CY
1545	Splash Pop 2	CY
1546	Splash Pop 3	CY
1547	Splash Pop 4	CY
1548	Splash Pop 5	CY
1549	Splash Pop 6	CY
1550	Splash Pop 7	CY
1551	Splash Pop 8	CY
1552	Splash Rock 1	CY

#	Drum Sample	DF
1553	Splash Rock 2	CY
1554	Splash Rock 3	CY
1555	Splash Rock 4	CY
1556	Splash U11 1	CY
1557	Splash U11 2	CY
1558	Splash U11 3	CY
1559	Splash U11 4	CY
1560	Splash 8' edge1	CY
1561	Splash 8' edge2	CY
1562	Splash	CY
1563	Chinese Pop 1	CY
1564	Chinese Pop 2	CY
1565	Chinese Pop 3	CY
1566	Chinese Pop 4	CY
1567	Chinese Pop 5	CY
1568	Chinese Pop 6	CY
1569	Chinese Pop 7	CY
1570	Chinese Pop 8	CY
1571	China Rock CYmb 1	CY
1572	China Rock CYmb 2	CY
1573	China Rock CYmb 3	CY
1574	China	CY
1575	Orchestra CYmbal	CY
1576	Finger Snaps	LP
1577	Finger Snap	LP
1578	Hand Claps 1	LP
1579	Hand Claps 2	LP
1580	Hand Claps 3	LP
1581	Hand Claps 4	LP
1582	Hand Claps 5	LP
1583	Claps Natural 1a	LP
1584	Claps Natural 1b	LP
1585	Claps Natural 1c	LP
1586	Claps Natural 1d	LP
1587	Claps Natural 2a	LP

#	Drum Sample	DF
1588	Claps Natural 2b	LP
1589	Claps Natural 2c	LP
1590	Claps Natural 2d	LP
1591	Claps Natural 2e	LP
1592	Claps Natural 3a	LP
1593	Claps Natural 3b	LP
1594	Claps Natural 3c	LP
1595	Claps Natural 3d	LP
1596	Claps Natural 3e	LP
1597	Claps Natural 3f	LP
1598	Claps Natural 3g	LP
1599	Claps Natural 3h	LP
1600	Claps1	LP
1601	Claps2	LP
1602	Claps3	LP
1603	Claps4	LP
1604	Claps Ensemble 1	LP
1605	Claps Ensemble 2	LP
1606	Claps Ensemble 3	LP
1607	Claps Ensemble 4	LP
1608	Claps Analog	LP
1609	Dance Claps1	LP
1610	Dance Claps2	LP
1611	Dance Claps3	LP
1612	Dance Claps4	LP
1613	Dance Claps5	LP
1614	Dance Claps6	LP
1615	Dance Conga1 Lo-Open	LP
1616	Dance Conga1 Hi-Open	LP
1617	Dance Tambourine	HP
1618	Electric Bongo	LP
1619	Syn. Bongo Hi	LP
1620	Syn. Bongo Low	LP
1621	Syn. Castanet	LP
1622	Syn. Shaker	HP

#	Drum Sample	DF
1623	Syn. Noise	SFX
1624	Syn. FX1	SFX
1625	Syn. FX2	SFX
1626	Syn. FX3	SFX
1627	Syn. FX4	SFX
1628	Syn. FX5	SFX
1629	Syn. Perc. Ahh	SFX
1630	Boom	SFX
1631	Zap1	SFX
1632	Zap2	SFX
1633	Vinyl Hit	SFX
1634	DJ Vinyl Sliced 01	SFX
1635	DJ Vinyl Sliced 02	SFX
1636	DJ Vinyl Sliced 03	SFX
1637	DJ Vinyl Sliced 04	SFX
1638	DJ Vinyl Sliced 05	SFX
1639	DJ Vinyl Sliced 06	SFX
1640	DJ Vinyl Sliced 07	SFX
1641	DJ Vinyl Sliced 08	SFX
1642	DJ Vinyl Sliced 09	SFX
1643	DJ Vinyl Sliced 10	SFX
1644	DJ Vinyl Sliced 11	SFX
1645	DJ Vinyl Sliced 12	SFX
1646	DJ Vinyl Sliced 13	SFX
1647	DJ Vinyl Sliced 14	SFX
1648	DJ Vinyl Sliced 15	SFX
1649	DJ Vinyl Sliced 16	SFX
1650	DJ Vinyl Sliced 17	SFX
1651	DJ Vinyl Sliced 18	SFX
1652	DJ Vinyl Sliced 19	SFX
1653	DJ Vinyl Sliced 20	SFX
1654	DJ Vinyl Sliced 21	SFX
1655	DJ Vinyl Sliced 22	SFX
1656	DJ Vinyl Sliced 23	SFX
1657	DJ Vinyl Sliced 24	SFX

#	Drum Sample	DF
1658	DJ Scratch1	SFX
1659	DJ Scratch2	SFX
1660	DJ Scratch3	SFX
1661	DJ Scratch4	SFX
1662	DJ Scratch5	SFX
1663	DJ Scratch6	SFX
1664	DJ Hit Rub	SFX
1665	DJ Vocal Rub1	SFX
1666	DJ Vocal Rub2	SFX
1667	DJ BD Rub	SFX
1668	DJ SD Rub	SFX
1669	Guiro Long Nat p	LP
1670	Guiro Long Nat f	LP
1671	Guiro Long	LP
1672	Guiro Short Nat p	LP
1673	Guiro Short Nat f	LP
1674	Guiro Short	LP
1675	Vibraslap	HP
1676	Vibraslap Amb	HP
1677	Long Whistle	HP
1678	Short Whistle	HP
1679	Samba Whistle	HP
1680	Samba Whistle Lp	HP
1681	Cuica Open 1	LP
1682	Cuica Open 2	LP
1683	Cuica Open 3	LP
1684	Cuica Mute 1	LP
1685	Cuica Mute 2	LP
1686	Cuica Hi	LP
1687	Cuica Lo	LP
1688	Surdo Open	LP
1689	Surdo Mute	LP
1690	Surdo Open GM	LP
1691	Surdo Mute GM	LP
1692	Tumba Open1 mf	LP

#	Drum Sample	DF
1693	Tumba Open1 f	LP
1694	Tumba Open2 mf	LP
1695	Tumba Open2 f	LP
1696	Tumba Open Flam	LP
1697	Tumba Glissando	LP
1698	Tumba Basstone	LP
1699	Tumba O.Slap Flam mf	LP
1700	Tumba O.Slap Flam f	LP
1701	Tumba Muffled	LP
1702	Low Conga 1	LP
1703	Low Conga 2	LP
1704	Low Conga 3	LP
1705	Low Conga 4	LP
1706	Low Conga 5	LP
1707	Conga1 Lo Basstone	LP
1708	Conga1 Lo Open mf	LP
1709	Conga1 Lo Open Slap	LP
1710	Conga1 Lo Glissando	LP
1711	Conga1 Lo Muffled	LP
1712	Conga1 Lo Closed	LP
1713	Conga1 Lo Closed Slap	LP
1714	Conga1 Lo Heel	LP
1715	Conga1 Lo Toe	LP
1716	Open Hi Conga 1	LP
1717	Open Hi Conga 2	LP
1718	Open Hi Conga 3	LP
1719	Open Hi Conga 4	LP
1720	Mute Hi Conga 1	LP
1721	Mute Hi Conga 2	LP
1722	Mute Hi Conga 3	LP
1723	Conga1 Hi Basstone mf	LP
1724	Conga1 Hi Basstone f	LP
1725	Conga1 Hi Open mf	LP
1726	Conga1 Hi Open Slap	LP

#	Drum Sample	DF
1727	Conga1 Hi Muffled	LP
1728	Conga1 Hi Closed	LP
1729	Conga1 Hi Closed Slap	LP
1730	Conga1 Hi Heel	LP
1731	Conga1 Hi Toe	LP
1732	Conga2 Lo Open	LP
1733	Conga2 Lo Mt Slap	LP
1734	Conga2 Lo Slap	LP
1735	Conga2 Hi Open	LP
1736	Conga2 Hi Mute	LP
1737	Conga2 Hi Mt Slap	LP
1738	Conga2 Hi Slap1	LP
1739	Conga2 Hi Slap2	LP
1740	Conga2 Heel	LP
1741	Conga2 Toe	LP
1742	Quinto1 Open	LP
1743	Quinto1 Closed	LP
1744	Quinto1 Closed Slap	LP
1745	Quinto1 Toe	LP
1746	Quinto2 Basstone	LP
1747	Quinto2 Open mp	LP
1748	Quinto2 Open Flam	LP
1749	Quinto2 Open Slap	LP
1750	Quinto2 Muffled	LP
1751	Quinto2 C.Slap Flam p	LP
1752	Quinto2 C.Slap Flam f	LP
1753	Quinto2 Heel	LP
1754	Low Bongo 1	LP
1755	Low Bongo 2	LP
1756	Low Bongo 3	LP
1757	Hi Bongo 1	LP
1758	Hi Bongo 2	LP
1759	Hi Bongo 3	LP
1760	Bongo1 Lo Muffled mp	LP

#	Drum Sample	DF
1761	Bongo1 Lo Muffled f	LP
1762	Bongo1 Lo Closed	LP
1763	Bongo1 Lo Flam	LP
1764	Bongo1 Lo MuffledFlam	LP
1765	Bongo1 Lo Stick	LP
1766	Bongo1 Lo StickEdge mf	LP
1767	Bongo1 Lo StickEdge f	LP
1768	Bongo1 Lo StickBounce	LP
1769	Bongo1 Lo Fingernail	LP
1770	Bongo1 Lo Cuptone	LP
1771	Bongo1 Lo Slap	LP
1772	Bongo1 Hi Open mf	LP
1773	Bongo1 Hi Open f	LP
1774	Bongo1 Hi Pops	LP
1775	Bongo1 Hi Hightone	LP
1776	Bongo1 Hi OpenFlam	LP
1777	Bongo1 Hi Fingernail	LP
1778	Bongo1 Hi Stick	LP
1779	Bongo1 Hi StickEdge mf	LP
1780	Bongo1 Hi StickEdge f	LP
1781	Bongo1 Hi StickBounce	LP
1782	Bongo1 Hi Cuptone	LP
1783	Bongo1 Hi Slap	LP
1784	Bongo2 Lo Open a	LP
1785	Bongo2 Lo Open b	LP
1786	Bongo2 Lo Mute	LP
1787	Bongo2 Hi Open a	LP
1788	Bongo2 Hi Open b	LP
1789	Bongo2 Hi Muffled	LP
1790	Bongo2 Hi Slap	LP
1791	Bongo2 Lo Heel	LP
1792	Bongo2 Lo Muffled	LP
1793	Bongo3 Lo Open	LP
1794	Bongo3 Lo Slap	LP

#	Drum Sample	DF
1795	Bongo3 Lo Stick	LP
1796	Bongo3 Hi Open	LP
1797	Bongo3 Hi Slap	LP
1798	Bongo3 Hi Stick1	LP
1799	Bongo3 Hi Stick2	LP
1800	Okonkolo Boca Open mp	LP
1801	Okonkolo Boca Open mf	LP
1802	Okonkolo Boca Open f	LP
1803	Okonkolo Boca Open ff	LP
1804	Okonkolo Cha Open p	LP
1805	Okonkolo Cha Open mf	LP
1806	Okonkolo Cha Open f	LP
1807	Okonkolo Cha Open ff	LP
1808	Okonkolo Cha Slap p	LP
1809	Okonkolo Cha Slap mf	LP
1810	Okonkolo Cha Slap f	LP
1811	Baya Open	LP
1812	Baya Ghe	LP
1813	Baya GheUp a	LP
1814	Baya GheUp b	LP
1815	Baya KaPalm	LP
1816	Baya KaToe a	LP
1817	Baya KaToe b	LP
1818	Baya Nail a	LP
1819	Baya Nail b	LP
1820	Baya Nail c	LP
1821	Baya Ge	LP
1822	Baya Up	LP
1823	Baya UpDown a	LP
1824	Baya UpDown b	LP
1825	Baya Mute1	LP
1826	Baya Mute2	LP
1827	Baya Mute3	LP
1828	Tabla1 Na	LP

#	Drum Sample	DF
1829	Tabla1 Open	LP
1830	Tabla1 Tin	LP
1831	Tabla1 Mute1	LP
1832	Tabla1 Mute2	LP
1833	Tabla1 Mute3	LP
1834	Tabla2 Tin a	LP
1835	Tabla2 Tin b	LP
1836	Tabla2 Na a	LP
1837	Tabla2 Na b	LP
1838	Tabla2 Na c	LP
1839	Tabla2 Tun a	LP
1840	Tabla2 Tun b	LP
1841	Tabla2 Tele a	LP
1842	Tabla2 Tele b	LP
1843	Tabla2 Tele c	LP
1844	Tabla2 Ti a	LP
1845	Tabla2 Ti b	LP
1846	Tabla2 Ti c	LP
1847	Tabla2 Tera	LP
1848	Tsuzumi	LP
1849	Taiko Open	LP
1850	Taiko Rim	LP
1851	Low Timbale 1	LP
1852	Low Timbale 2	LP
1853	Low Timbale 3	LP
1854	Low Timbale 4	LP
1855	Low Timbale 5	LP
1856	Timbales1 Lo Op mp	LP
1857	Timbales1 Lo Op mf	LP
1858	Timbales1 Lo Op mf GM	LP
1859	Timbales1 Lo Edge mf	LP
1860	Timbales1 Lo Edge f	LP
1861	Timbales1 Lo RimShot	LP
1862	Timbales1 Lo Abanico	LP

#	Drum Sample	DF
1863	Timbales1 Lo Roll	LP
1864	Timbales1 Lo Mute mf	LP
1865	Timbales1 Lo Mute f	LP
1866	Timbales1 Lo Paila mf	HP
1867	Timbales1 Lo Paila f	HP
1868	High Timbale 1	LP
1869	High Timbale 2	LP
1870	High Timbale 3	LP
1871	High Timbale 4	LP
1872	High Timbale 5	LP
1873	Timbales1 Hi Open	LP
1874	Timbales1 Hi Edge	LP
1875	Timbales1 Hi Edge GM	LP
1876	Timbales1 Hi Rim p	LP
1877	Timbales1 Hi Rim mf	LP
1878	Timbales1 Hi Rim f	LP
1879	Timbales1 Hi Abanico1	LP
1880	Timbales1 Hi Abanico2	LP
1881	Timbales1 Hi Mute	LP
1882	Timbales1 Hi Paila mf	HP
1883	Timbales1 Hi Paila f	HP
1884	Timbales2 Lo Open	LP
1885	Timbales2 Lo Mute	LP
1886	Timbales2 Lo Rim	LP
1887	Timbales2 Hi Edge	LP
1888	Timbales2 Hi Rim1	LP
1889	Timbales2 Hi Rim2	LP
1890	Timbales2 Paila	HP
1891	Cowbell Amb	HP
1892	Cowbell1	HP
1893	Cowbell2	HP
1894	Cowbell3	HP
1895	Cowbell4 Open	HP
1896	Cowbell4 Mute	HP

#	Drum Sample	DF
1897	Cowbell5 Open a	HP
1898	Cowbell5 Open b	HP
1899	Cowbell5 Mute	HP
1900	Cowbell6	HP
1901	Cowbell7-Open	HP
1902	Cowbell7-Mute	HP
1903	Cowbell Rock 1	HP
1904	Cowbell Rock 2	HP
1905	Cowbell Rock 3	HP
1906	Cowbell Rock 4	HP
1907	Hi Agogo	HP
1908	Low Agogo	HP
1909	Agogo Bell	HP
1910	Chacha Bell	HP
1911	Mambo Bell	HP
1912	Recoreco short1	HP
1913	Recoreco short2	HP
1914	Recoreco short3	HP
1915	Recoreco long	HP
1916	Open Triangle p	HP
1917	Open Triangle f	HP
1918	Triangle1 Open	HP
1919	Triangle2 Open Lp	HP
1920	Triangle2 Closed c	HP
1921	Mute Triangle p	HP
1922	Mute Triangle f	HP
1923	Triangle1 Mute	HP
1924	Sleigh Bell	HP
1925	Rap Sleigh Bell	HP
1926	Jingle Bell Amb	HP
1927	Jingle Bell	HP
1928	Bells Open	HP
1929	Finger CYmbal	HP
1930	Marc Tree	HP

#	Drum Sample	DF
1931	Marc Tree GM	HP
1932	Marc TreeLP	HP
1933	Marc Tree Amb	HP
1934	Rainstick	SFX
1935	Flexatone	HP
1936	Chinese Gong	CY
1937	Claves p	LP
1938	Claves f	LP
1939	Claves1 Lo a	LP
1940	Claves1 Lo b	LP
1941	Claves1 Hi a	LP
1942	Claves1 Hi b	LP
1943	Claves2	LP
1944	Low Wood Block p	LP
1945	Low Wood Block f	LP
1946	Hi Wood Block p	LP
1947	Hi Wood Block f	LP
1948	Wood Block 1 a	LP
1949	Wood Block 1 b	LP
1950	Wood Block 2 a	LP
1951	Wood Block 2 b	LP
1952	Wood Block 3 a	LP
1953	Wood Block 3 b	LP
1954	Wood Block 4 a	LP
1955	Wood Block 4 b	LP
1956	Wood Block 5 a	LP
1957	Wood Block 5 b	LP
1958	Wood Block 6 a	LP
1959	Wood Block 6 b	LP
1960	Wood Block 7	LP
1961	Wood Block 8	LP
1962	Castanet Amb	LP
1963	Castanet 1 a	LP
1964	Castanet 1 b	LP

#	Drum Sample	DF
1965	Castanet 1 c	LP
1966	Castanet 2	LP
1967	Castanet Single	LP
1968	Castanet Single GM	LP
1969	Castanet Double	LP
1970	Cabasa Amb 1	HP
1971	Cabasa Amb 2	HP
1972	Cabasa Amb 3	HP
1973	Cabasa 1 L a Down	HP
1974	Cabasa 1 L a Up	HP
1975	Cabasa 1 L b Down	HP
1976	Cabasa 1 L b Up	HP
1977	Cabasa 1 S a Down	HP
1978	Cabasa 1 S a Up	HP
1979	Cabasa 1 S b Down	HP
1980	Cabasa 1 S b up	HP
1981	Cabasa 2 L Stack b	HP
1982	Cabasa 2 L Stack a	HP
1983	Cabasa 2 L Roll	HP
1984	Cabasa 2 S Stack a	HP
1985	Cabasa 2 S Stack b	HP
1986	Cabasa 2 S Roll	HP
1987	Cabasa 3 WS	HP
1988	Cabasa 3 Up	HP
1989	Cabasa 3 Down	HP
1990	Cabasa 3 Tap	HP
1991	Caxixil a	HP
1992	Caxixil b	HP
1993	Caxixil c	HP
1994	Caxixi2 a	HP
1995	Caxixi2 b	HP
1996	Caxixi2 c	HP
1997	Caxixi3 Hard	HP
1998	Caxixi3 Soft	HP

#	Drum Sample	DF
1999	Shaker Amb	HP
2000	Shaker1 Push a	HP
2001	Shaker1 Push b	HP
2002	Shaker1 Pull a	HP
2003	Shaker1 Pull b	HP
2004	Shaker1 Accent a	HP
2005	Shaker1 Accent b	HP
2006	Shaker1 Slow a	HP
2007	Shaker1 Slow b	HP
2008	Shaker1 Slow c	HP
2009	Shaker1 Roll a	HP
2010	Shaker1 Roll b	HP
2011	Shaker1 Roll c	HP
2012	Shaker2	HP
2013	Shaker3	HP
2014	Maracas Amb 1	HP
2015	Maracas Amb 2	HP
2016	Maracas Amb 3	HP
2017	Maracas Amb 4	HP
2018	Maracas Push	HP
2019	Maracas Pull	HP
2020	Dumbek a	LP
2021	Dumbek b	LP
2022	Dumbek c	LP
2023	Dumbek d	LP
2024	Dumbek e	LP
2025	Dumbek f	LP
2026	Dumbek g	LP
2027	Dumbek h	LP
2028	Dumbek i	LP
2029	Dumbek j	LP
2030	Dumbek k	LP
2031	Djembe L Basstone a	LP
2032	Djembe L Basstone b	LP

#	Drum Sample	DF
2033	Djembe L Basstone c	LP
2034	Djembe L Open	LP
2035	Djembe L Open Slap	LP
2036	Djembe L Closed Slap	LP
2037	Djembe S Basstone a	LP
2038	Djembe S Basstone b	LP
2039	Djembe S Basstone c	LP
2040	Djembe Open	LP
2041	Djembe Mute	LP
2042	Djembe Slap	LP
2043	Djembe S Open	LP
2044	Djembe S Open Slap a	LP
2045	Djembe S Open Slap b	LP
2046	Djembe S Closed Slap a	LP
2047	Djembe S Closed Slap b	LP
2048	Djembe S Closed Slap c	LP
2049	Djembe Bass	LP
2050	Udu Open a	LP
2051	Udu Open b	LP
2052	Udu Open c	LP
2053	Udu Open d	LP
2054	Udu Slide a	HP
2055	Udu Slide b	HP
2056	Udu Half Open a	LP
2057	Udu Half Open b	LP
2058	Udu Half Open c	LP
2059	Udu Bell a	LP
2060	Udu Bell b	LP
2061	WD Brazillia1	SD
2062	WD Brazillia2	SD
2063	WD Ethno SD1	SD
2064	WD Ethno SD2	SD
2065	WD Ethno SD3	SD
2066	WD Ethno SD4	SD

#	Drum Sample	DF
2067	WD Ethno SD5	SD
2068	WD Ethno SD6	SD
2069	WD Kangaroo1	SFX
2070	WD Kangaroo2	SFX
2071	WD Kangaroo3	SFX
2072	WD Kangaroo4	SFX
2073	WD Kangaroo5	SFX
2074	WD Kangaroo6	SFX
2075	WD Kangaroo7	SFX
2076	WD Kangaroo8	SFX
2077	Tambourine Push	HP
2078	Tambourine Pull	HP
2079	Tambourine Acc1 A	HP
2080	Tambourine Acc1 B	HP
2081	Tambourine Acc2	HP
2082	Tambourine Mute1	LP
2083	Tambourine Mute2	LP
2084	Tambourine Open	LP
2085	Tambourine Nat 1	HP
2086	Tambourine Nat 2	HP
2087	Tambourine Nat 3	HP
2088	Tambourine Nat 4	HP
2089	Tambourine Nat 5	HP
2090	Tambourine Rock 1	HP
2091	Tambourine Rock 2	HP
2092	Tambourine Rock 3	HP
2093	Tambourine Rock 4	HP
2094	M.E.1 Douf Rim Ak	LP
2095	M.E.1 Douf Tek Ak1	LP
2096	M.E.1 Douf Tek Ak2	LP
2097	M.E.1 Pand Open	LP
2098	M.E.1 Pand Pattern1	LP
2099	M.E.1 Pand Pattern2	LP
2100	M.E.1 Pand Pattern3	LP

#	Drum Sample	DF
2101	M.E.1 Pand Pattern4	LP
2102	M.E.1 Rek Dom Ak	HP
2103	M.E.1 Rek Jingle	HP
2104	M.E.1 Rik1	LP
2105	M.E.1 Rik2	LP
2106	M.E.1 Rik3	LP
2107	M.E.1 Sagat Half Open	HP
2108	M.E.1 Sagat Close	HP
2109	M.E.1 Surdo L Open	LP
2110	M.E.1 Surdo L Mute	LP
2111	M.E.1 Tabla Medium	LP
2112	M.E.1 Tabla Dom	LP
2113	M.E.1 Tabla Flam	LP
2114	M.E.1 Tabla Rim	LP
2115	M.E.1 Tabla Tak	LP
2116	M.E.1 Timbales	HP
2117	M.E.1 Udu f Open	LP
2118	M.E.1 Alkis	LP
2119	M.E.1 Bandir Open	LP
2120	M.E.1 Bandir Closed	LP
2121	M.E.1 Bongo Roll	LP
2122	M.E.1 Darbuka1 Tek1	LP
2123	M.E.1 Darbuka1 Tek2	LP
2124	M.E.1 Darbuka1 Open	LP
2125	M.E.1 Darbuka1 Closed	LP
2126	M.E.1 Darbuka2	LP
2127	M.E.1 Darbuka3	LP
2128	M.E.1 Darbuka4	LP
2129	M.E.1 Darbuka5 D1	LP
2130	M.E.1 Darbuka5 D2	LP
2131	M.E.1 Darbuka5 D3	LP
2132	M.E.1 Darbuka6 Mute	LP
2133	M.E.1 Darbuka6 Open	LP
2134	M.E.1 Darbuka6 Rim	LP

#	Drum Sample	DF
2135	M.E.1 Darbuka6 Dom Ak	LP
2136	M.E.1 Davul	HP
2137	M.E.1 Hollo1	LP
2138	M.E.1 Hollo2	LP
2139	M.E.1 Kup1	LP
2140	M.E.1 Kup2	LP
2141	M.E.1 Ramazan Davul1	LP
2142	M.E.1 Ramazan Davul2	LP
2143	M.E.1 Ramazan Davul3	LP
2144	M.E.1 Tef1	HP
2145	M.E.1 Tef2	HP
2146	M.E.1 Tef3	HP
2147	M.E.2 BD Kick	BD
2148	M.E.2 SD	SD
2149	M.E.2 Asagum	LP
2150	M.E.2 Asmatek	LP
2151	M.E.2 Bendirgum	LP
2152	M.E.2 Bendirtek1	LP
2153	M.E.2 Bendirtek2	LP
2154	M.E.2 Dm1	LP
2155	M.E.2 Findik	LP
2156	M.E.2 Gum	LP
2157	M.E.2 Hollotokat	LP
2158	M.E.2 Islik1	SFX
2159	M.E.2 Islik2	SFX
2160	M.E.2 Kapital	LP
2161	M.E.2 Kasik1	LP
2162	M.E.2 Kasik2	LP
2163	M.E.2 Kasik3	LP
2164	M.E.2 Kasik4	LP
2165	M.E.2 Kemik	LP
2166	M.E.2 Kenar1	LP
2167	M.E.2 Kenartek	LP
2168	M.E.2 Ramazangum	LP

#	Drum Sample	DF
2169	M.E.2 Ramazantek	LP
2170	M.E.2 Renk	LP
2171	M.E.2 Renkbir	LP
2172	M.E.2 Renkiki	LP
2173	M.E.2 Tefacik	LP
2174	M.E.2 Tefgum	LP
2175	M.E.2 Teftek1	LP
2176	M.E.2 Teftokat	LP
2177	M.E.2 Teftrill	LP
2178	M.E.2 Tefzil	LP
2179	M.E.2 Tek1	LP
2180	M.E.2 Tek2	LP
2181	M.E.2 Tekbir	LP
2182	M.E.2 Tokat	LP
2183	M.E.2 Toprgum	LP
2184	M.E.2 Toprtek1	LP
2185	M.E.2 Toprtek2	LP
2186	M.E.2 Toprtokat	LP
2187	M.E.2 TRILL1	LP
2188	M.E.2 Zil1	HP
2189	M.E.2 Zil2	HP
2190	M.E.2 Zil3	HP
2191	M.E.2 Zilgit	SFX
2192	Orchestra Hit	SFX
2193	Band Hit	SFX
2194	Impact Hit	SFX
2195	Metal Hit	SFX
2196	Yeah!	SFX
2197	Yeah! Solo	SFX
2198	Uhh	SFX
2199	Hit It	SFX
2200	Uhhhh Solo	SFX
2201	Comp Voice Noise	SFX
2202	Stadium Amb	SFX

#	Drum Sample	DF
2203	Stadium	SFX
2204	Applause Amb	SFX
2205	Applause	SFX
2206	Scream	SFX
2207	Laughing	SFX
2208	Footsteps1	SFX
2209	Footsteps2	SFX
2210	Bird1	SFX
2211	Bird2	SFX
2212	Dog	SFX
2213	Gallop	SFX
2214	Crickets	SFX
2215	Cat	SFX
2216	Growl	SFX
2217	Heart Beat	SFX
2218	Heart Beat GM	SFX
2219	Punch	SFX
2220	Tribe	SFX
2221	Door Creak	SFX
2222	Door Slam	SFX
2223	Car Engine	SFX
2224	Car Stop	SFX
2225	Car Pass	SFX
2226	Car Crash	SFX
2227	Train	SFX
2228	Helicopter	SFX
2229	Gun Shot1	SFX
2230	Gun Shot2	SFX
2231	Machine Gun	SFX
2232	Laser Gun	SFX
2233	Explosion	SFX
2234	Thunder	SFX
2235	Wind	SFX
2236	Stream	SFX

#	Drum Sample	DF
2237	Bubble	SFX
2238	Bubble GM	SFX
2239	Church Bell	SFX
2240	Telephone Ring	SFX
2241	Xylophone Spectr	SFX
2242	Cricket Spectrum	SFX
2243	Air Vortex	SFX
2244	Noise White	SFX
2245	Noise FM Mod	SFX
2246	Tubular	HP
2247	Gamelan	HP
2248	Tambura	HP
2249	Gtr Cut Noise1	SFX
2250	Gtr Cut Noise2	SFX
2251	Power Chord	SFX
2252	Fret Noise	SFX
2253	Dist. Slide1	SFX
2254	Dist. Slide2	SFX
2255	E.Gtr Pick1	SFX
2256	E.Gtr Pick2	SFX
2257	Gtr Scratch1	SFX
2258	Gtr Scratch2	SFX
2259	Ac.Bs-String Slap	SFX
2260	Amp Noise	SFX
2261	Space Lore	SFX
2262	Swish Terra	SFX
2263	Hand Drill	SFX
2264	Mouth Harp	SFX
2265	Slice Groove A 001	BD
2266	Slice Groove A 002	SD
2267	Slice Groove A 003	SD
2268	Slice Groove A 004	SD
2269	Slice Groove A 005	SFX
2270	Slice Groove A 006	SD

#	Drum Sample	DF
2271	Slice Groove A 007	BD
2272	Slice Groove A 008	BD
2273	Slice Groove A 009	BD
2274	Slice Groove A 010	SFX
2275	Slice Groove A 011	SD
2276	Slice Groove A 012	SD
2277	Slice Groove A 013	SFX
2278	Slice Groove A 014	SFX
2279	Slice Groove A 015	SD
2280	Slice Groove A 016	SFX
2281	Slice Groove A 017	SFX
2282	Slice Groove A 018	SFX
2283	Slice Groove A 019	SFX
2284	Slice Groove A 020	BD
2285	Slice Groove A 021	HH
2286	Slice Groove A 022	SFX
2287	Slice Groove A 023	SD
2288	Slice Groove A 024	SFX
2289	Slice Groove A 025	BD
2290	Slice Groove A 026	SD
2291	Slice Groove A 027	BD
2292	Slice Groove A 028	BD
2293	Slice Groove A 029	SD
2294	Slice Groove A 030	SD
2295	Slice Groove A 031	SD
2296	Slice Groove A 032	SD
2297	Slice Groove A 033	SD
2298	Slice Groove A 034	SD
2299	Slice Groove A 035	SD
2300	Slice Groove A 036	BD
2301	Slice Groove A 037	BD
2302	Slice Groove A 038	SD
2303	Slice Groove A 039	SD
2304	Slice Groove A 040	SFX

#	Drum Sample	DF
2305	Slice Groove A 041	SFX
2306	Slice Groove A 042	SD
2307	Slice Groove A 043	SFX
2308	Slice Groove A 044	SFX
2309	Slice Groove A 045	SFX
2310	Slice Groove A 046	SFX
2311	Slice Groove A 047	SFX
2312	Slice Groove A 048	SFX
2313	Slice Groove A 049	SFX
2314	Slice Groove A 050	SFX
2315	Slice Groove A 051	SD
2316	Slice Groove A 052	SFX
2317	Slice Groove A 053	SFX
2318	Slice Groove A 054	SD
2319	Slice Groove A 055	HH
2320	Slice Groove A 056	SD
2321	Slice Groove A 057	SFX
2322	Slice Groove A 058	BD
2323	Slice Groove A 059	SD
2324	Slice Groove A 060	SD
2325	Slice Groove A 061	SD
2326	Slice Groove A 062	TM
2327	Slice Groove A 063	TM
2328	Slice Groove A 064	BD
2329	Slice Groove A 065	SFX
2330	Slice Groove A 066	SFX
2331	Slice Groove A 067	SFX
2332	Slice Groove A 068	SD
2333	Slice Groove A 069	SFX
2334	Slice Groove A 070	SFX
2335	Slice Groove A 071	SFX
2336	Slice Groove A 072	SFX
2337	Slice Groove A 073	BD
2338	Slice Groove A 074	SD

#	Drum Sample	DF
2339	Slice Groove A 075	BD
2340	Slice Groove A 076	SFX
2341	Slice Groove A 077	SD
2342	Slice Groove A 078	BD
2343	Slice Groove A 079	SFX
2344	Slice Groove A 080	SFX
2345	Slice Groove A 081	SFX
2346	Slice Groove A 082	BD
2347	Slice Groove A 083	BD
2348	Slice Groove A 084	SFX
2349	Slice Groove A 085	BD
2350	Slice Groove A 086	SD
2351	Slice Groove A 087	SFX
2352	Slice Groove A 088	BD
2353	Slice Groove A 089	BD
2354	Slice Groove A 090	HH
2355	Slice Groove A 091	BD
2356	Slice Groove A 092	SD
2357	Slice Groove A 093	SFX
2358	Slice Groove A 094	SFX
2359	Slice Groove A 095	SFX
2360	Slice Groove A 096	SFX
2361	Slice Groove A 097	BD
2362	Slice Groove A 098	BD
2363	Slice Groove A 099	SD
2364	Slice Groove A 100	SFX
2365	Slice Groove A 101	SFX
2366	Slice Groove A 102	SFX
2367	Slice Groove A 103	SFX
2368	Slice Groove A 104	SFX
2369	Slice Groove A 105	SFX
2370	Slice Groove A 106	BD
2371	Slice Groove A 107	SFX
2372	Slice Groove A 108	SFX

#	Drum Sample	DF
2373	Slice Groove A 109	SFX
2374	Slice Groove A 110	SFX
2375	Slice Groove A 111	HH
2376	Slice Groove A 112	SFX
2377	Slice Groove A 113	BD
2378	Slice Groove A 114	SD
2379	Slice Groove A 115	SFX
2380	Slice Groove A 116	SFX
2381	Slice Groove A 117	SFX
2382	Slice Groove A 118	SFX
2383	Slice Groove A 119	HH
2384	Slice Groove A 120	BD
2385	Slice Groove A 121	SFX
2386	Slice Groove A 122	SFX
2387	Slice Groove A 123	SFX
2388	Slice Groove A 124	SD
2389	Slice Groove A 125	SD
2390	Slice Groove A 126	SD
2391	Slice Groove A 127	BD
2392	Slice Groove A 128	SD
2393	Slice Groove B 001	SD
2394	Slice Groove B 002	BD
2395	Slice Groove B 003	BD
2396	Slice Groove B 004	BD
2397	Slice Groove B 005	SFX
2398	Slice Groove B 006	SFX
2399	Slice Groove B 007	SFX
2400	Slice Groove B 008	BD
2401	Slice Groove B 009	SD
2402	Slice Groove B 010	HH
2403	Slice Groove B 011	BD
2404	Slice Groove B 012	BD
2405	Slice Groove B 013	SD
2406	Slice Groove B 014	SD

#	Drum Sample	DF
2407	Slice Groove B 015	SFX
2408	Slice Groove B 016	BD
2409	Slice Groove B 017	SD
2410	Slice Groove B 018	SFX
2411	Slice Groove B 019	SFX
2412	Slice Groove B 020	SFX
2413	Slice Groove B 021	SFX
2414	Slice Groove B 022	BD
2415	Slice Groove B 023	HH
2416	Slice Groove B 024	SFX
2417	Slice Groove B 025	SFX
2418	Slice Groove B 026	SFX
2419	Slice Groove B 027	BD
2420	Slice Groove B 028	SD
2421	Slice Groove B 029	SFX
2422	Slice Groove B 030	SFX
2423	Slice Groove B 031	SFX
2424	Slice Groove B 032	BD
2425	Slice Groove B 033	BD
2426	Slice Groove B 034	HH
2427	Slice Groove B 035	HH
2428	Slice Groove B 036	HH
2429	Slice Groove B 037	SFX
2430	Slice Groove B 038	BD
2431	Slice Groove B 039	BD
2432	Slice Groove B 040	BD
2433	Slice Groove B 041	SFX
2434	Slice Groove B 042	SD
2435	Slice Groove B 043	SD
2436	Slice Groove B 044	HH
2437	Slice Groove B 045	BD
2438	Slice Groove B 046	SD
2439	Slice Groove B 047	SFX
2440	Slice Groove B 048	SFX

#	Drum Sample	DF
2441	Slice Groove B 049	SFX
2442	Slice Groove B 050	BD
2443	Slice Groove B 051	SFX
2444	Slice Groove B 052	BD
2445	Slice Groove B 053	SFX
2446	Slice Groove B 054	SFX
2447	Slice Groove B 055	SFX
2448	Slice Groove B 056	SFX
2449	Slice Groove B 057	SFX
2450	Slice Groove B 058	SFX
2451	Slice Groove B 059	HH
2452	Slice Groove B 060	SD
2453	Slice Groove B 061	SFX
2454	Slice Groove B 062	SFX
2455	Slice Groove B 063	SFX
2456	Slice Groove B 064	BD
2457	Slice Groove B 065	BD
2458	Slice Groove B 066	SFX
2459	Slice Groove B 067	SFX
2460	Slice Groove B 068	SFX
2461	Slice Groove B 069	SFX
2462	Slice Groove B 070	SD
2463	Slice Groove B 071	SFX
2464	Slice Groove B 072	SD
2465	Slice Groove B 073	SFX
2466	Slice Groove B 074	HH
2467	Slice Groove B 075	BD
2468	Slice Groove B 076	SFX
2469	Slice Groove B 077	SFX
2470	Slice Groove B 078	SD
2471	Slice Groove B 079	SFX
2472	Slice Groove B 080	BD
2473	Slice Groove B 081	SD
2474	Slice Groove B 082	SD

#	Drum Sample	DF
2475	Slice Groove B 083	SD
2476	Slice Groove B 084	SFX
2477	Slice Groove B 085	SD
2478	Slice Groove B 086	HH
2479	Slice Groove B 087	SD
2480	Slice Groove B 088	SD
2481	Slice Groove B 089	SD
2482	Slice Groove B 090	SD
2483	Slice Groove B 091	SD
2484	Slice Groove B 092	SD
2485	Slice Groove B 093	BD
2486	Slice Groove B 094	SFX
2487	Slice Groove B 095	SFX
2488	Slice Groove B 096	SFX
2489	Slice Groove B 097	SFX
2490	Slice Groove B 098	SFX
2491	Slice Groove B 099	BD
2492	Slice Groove B 100	SFX
2493	Slice Groove B 101	SD
2494	Slice Groove B 102	SFX
2495	Slice Groove B 103	BD
2496	Slice Groove B 104	BD
2497	Slice Groove B 105	HH
2498	Slice Groove B 106	BD
2499	Slice Groove B 107	SFX
2500	Slice Groove B 108	SFX
2501	Slice Groove B 109	HH
2502	Slice Groove B 110	SFX
2503	Slice Groove B 111	HH
2504	Slice Groove B 112	BD
2505	Slice Groove B 113	BD
2506	Slice Groove B 114	SFX
2507	Slice Groove B 115	SD
2508	Slice Groove B 116	SD

#	Drum Sample	DF
2509	Slice Groove B 117	HH
2510	Slice Groove B 118	SFX
2511	Slice Groove B 119	SD
2512	Slice Groove B 120	BD
2513	Slice Groove B 121	BD
2514	Slice Groove B 122	SFX
2515	Slice Groove B 123	BD
2516	Slice Groove B 124	SFX
2517	Slice Groove B 125	SFX
2518	Slice Groove B 126	SD
2519	Slice Groove B 127	SFX
2520	Slice Groove B 128	SFX
2521	Grv BD1	BD
2522	Grv BD2	BD
2523	Grv BD3	BD
2524	Grv BD4	BD
2525	Grv BD5	BD
2526	Grv BD6	BD
2527	Grv BD7	BD
2528	Grv BD8	BD
2529	Grv BD9	BD
2530	Grv BD10	BD
2531	Grv BD11	BD
2532	Grv BD12	BD
2533	Grv BD13	BD
2534	Grv BD14	BD
2535	Grv BD15	BD
2536	Grv BD16	BD
2537	Grv BD17	BD
2538	Grv BD18	BD
2539	Grv BD19	BD
2540	Grv BD20	BD
2541	Grv BD21	BD
2542	Grv BD22	BD

#	Drum Sample	DF
2543	Grv BD23	BD
2544	Grv SD1	SD
2545	Grv SD2	SD
2546	Grv SD3	SD
2547	Grv SD4	SD
2548	Grv SD5	SD
2549	Grv SD6	SD
2550	Grv SD7	SD
2551	Grv SD8	SD
2552	Grv SD9	SD
2553	Grv SD10	SD
2554	Grv SD11	SD
2555	Grv SD12	SD
2556	Grv SD13	SD
2557	Grv SD14	SD
2558	Grv SD15	SD
2559	Grv SD16	SD
2560	Grv SD17	SD
2561	Grv Rim1	SD
2562	Grv Rim2	SD
2563	Grv Rim3	SD
2564	Grv Rim4	SD
2565	Grv Rim5	SD
2566	Grv Rim6	SD
2567	Grv HH Closed1	HH
2568	Grv HH Closed2	HH
2569	Grv HH Closed3	HH
2570	Grv HH Closed4	HH
2571	Grv HH Closed5	HH
2572	Grv HH Closed6	HH
2573	Grv HH Closed7	HH
2574	Grv HH Closed8	HH
2575	Grv HH Closed9	HH
2576	Grv HH Closed10	HH

#	Drum Sample	DF
2577	Grv HH Closed11	HH
2578	Grv HH Closed12	HH
2579	Grv HH Closed13	HH
2580	Grv HH Closed14	HH
2581	Grv HH Closed15	HH
2582	Grv HH Closed16	HH
2583	Grv HH Closed17	HH
2584	Grv HH Open1	HH
2585	Grv HH Open2	HH
2586	Grv HH Open3	HH
2587	Grv HH Open4	HH
2588	Grv Hi Tom1	TM
2589	Grv Hi Tom2	TM
2590	Grv Low Tom1	TM
2591	Grv Low Tom2	TM
2592	Grv Ride	CY
2593	Grv Crash1	CY
2594	Grv Crash2	CY
2595	Grv Claps1	LP
2596	Grv Claps2	LP
2597	Grv Claps3	LP
2598	Grv Claps4	LP
2599	Grv Claps5	LP
2600	Grv Claps6	LP
2601	Grv Claps7	LP
2602	Grv Claps8	LP
2603	Grv Claps9	LP
2604	Grv Claps10	LP
2605	Grv Fx1	SFX
2606	Grv Fx2	SFX
2607	Grv Fx3	SFX
2608	Grv Fx4	SFX
2609	Grv Fx5	SFX
2610	Grv Fx6	SFX

#	Drum Sample	DF
2611	Grv Fx7	SFX
2612	Grv Fx8	SFX
2613	Grv Fx9	SFX
2614	Grv Fx10	SFX
2615	Grv Fx11	SFX
2616	Grv Fx12	SFX
2617	Grv Fx13	SFX
2618	Grv Fx14	SFX
2619	Grv Fx15	SFX
2620	Grv Fx16	SFX
2621	Grv Fx17	SFX
2622	Grv Fx18	SFX
2623	Grv Fx19	SFX
2624	Grv Fx20	SFX
2625	Grv Fx21	SFX
2626	Grv Fx22	SFX
2627	Grv Fx23	SFX
2628	Grv Fx24	SFX
2629	Grv Fx25	SFX
2630	Grv Fx26	SFX
2631	Grv Fx27	SFX
2632	Grv Fx28	SFX
2633	Grv Fx29	SFX
2634	Grv Fx30	SFX
2635	Grv Fx31	SFX
2636	Grv Fx32	SFX
2637	Grv Fx33	SFX
2638	Grv Fx34	SFX
2639	Grv Fx35	SFX
2640	Grv Slice1	SFX
2641	Grv Slice2	SFX
2642	Grv Slice3	SFX
2643	Grv Slice4	SFX
2644	Grv Slice5	SFX

#	Drum Sample	DF
2645	Grv Slice6	SFX
2646	Grv Slice7	SFX
2647	Grv Slice8	SFX
2648	Grv Slice9	SFX
2649	Grv Slice10	SFX
2650	Grv Slice11	SFX
2651	Grv Slice12	SFX
2652	Grv Slice13	SFX
2653	Grv Slice14	SFX
2654	Grv Slice15	SFX
2655	Grv Slice16	SFX
2656	Grv Slice17	SFX
2657	Grv Slice18	SFX
2658	Grv Slice19	SFX
2659	Grv Slice20	SFX
2660	Grv Slice21	SFX
2661	Grv Slice22	SFX
2662	Grv Slice23	SFX
2663	55 BD	BD
2664	55 Claps	LP
2665	55 CongaHi	LP
2666	55 CongaLow	LP
2667	55 Cowbell Hi	HP
2668	55 Cowbell Low	HP
2669	55 Crash	CY
2670	55 HH Close	HH
2671	55 HH Open	HH
2672	55 Ride	CY
2673	55 Rim	SD
2674	55 SD	SD
2675	55 Timbales Hi	LP
2676	55 Tom Hi	TM
2677	55 Tom Mid	TM
2678	55 Tom Low	TM

#	Drum Sample	DF
2679	66 BD	BD
2680	66 SD	SD
2681	66 HH Close	HH
2682	66 HH Open	HH
2683	66 Tom	TM
2684	66 Congas	LP
2685	66 CYmbal	CY
2686	66 Cowbell	HP
2687	78 BD	BD
2688	78 SD1	SD
2689	78 SD2	SD
2690	78 HH Cl1	HH
2691	78 HH Cl2	HH
2692	78 HH Open	HH
2693	78 Tom	TM
2694	78 CYmbal	CY
2695	78 Bongos	LP
2696	78 Congas	LP
2697	78 Claves	LP
2698	88 BD1	BD
2699	88 BD2	BD
2700	88 BD Long	BD
2701	88 SD1	SD
2702	88 SD2	SD
2703	88 SD2 GM	SD
2704	88 SD3	SD
2705	88 SD3 GM	SD
2706	88 RIM Shot1	SD
2707	88 Rim Shot2	SD
2708	88 Rim Shot2 GM	SD
2709	88 HH Close1	HH
2710	88 HH Close1 acc	HH
2711	88 HH Close1 acc GM	HH
2712	88 HH Close2	HH

#	Drum Sample	DF
2713	88 HH Close2 GM	HH
2714	88 HH Open1	HH
2715	88 HH Open1 GM	HH
2716	88 HH Open2	HH
2717	88 Tom1	TM
2718	88 Tom2	TM
2719	88 CYmbal	CY
2720	88 CYmbal Acc1	CY
2721	88 CYmbal Acc2	CY
2722	88 Crash	CY
2723	88 Crash GM	CY
2724	88 Bongos	LP
2725	88 Congas1	LP
2726	88 Congas2	LP
2727	88 Claps1	LP
2728	88 Claps2	LP
2729	88 Claves	LP
2730	88 Cowbell	HP
2731	88 Maracas	HP
2732	99 BD1	BD
2733	99 BD2	BD
2734	99 BD3	BD
2735	99 SD1	SD
2736	99 SD2	SD
2737	99 SD3	SD
2738	99 RIM Shot	SD
2739	99 HH Close1	HH
2740	99 HH Close2	HH
2741	99 HH Close3	HH
2742	99 HH Open1	HH
2743	99 HH Open2	HH
2744	99 HH Open3	HH
2745	99 Tom Hi	TM
2746	99 Tom Mid	TM

#	Drum Sample	DF
2747	99 Tom Low	TM
2748	99 Claps	LP
2749	99 Guiro1	LP
2750	99 Guiro2	LP
2751	99 Ride	CY
2752	99 Ride Dance	CY
2753	99 Crash1	CY
2754	99 Crash2	CY
2755	99 Crash3	CY
2756	99 Cabasa	HP
2757	99 Bongo Hi	LP
2758	99 Bongo Low	LP
2759	99 Agogo Hi	HP
2760	99 Agogo Low	HP
2761	99 Conga Hi	LP
2762	99 Conga Mid	LP
2763	99 Conga Low	LP
2764	99 WoodBlock	LP
2765	99 Timbale Hi	LP
2766	99 Timbale Mid	LP
2767	99 Metal	HP
2768	Click	SFX
2769	Click GM	SFX
2770	Seq Click	SFX
2771	Metronome W Bell	SFX
2772	Metronome W	SFX
2773	BR_Agg2Bc1grv1	HP
2774	BR_Agg2Bc1grv2	HP
2775	BR_Agg2Bc1grv3	HP
2776	BR_Agg2Bc1grv4	HP
2777	BR_Agg2Bc1grv5	HP
2778	BR_Agg2Bc2agu1	HP
2779	BR_Agg2Bc2agu2	HP
2780	BR_Agg2Bc2agu3	HP

#	Drum Sample	DF
2781	BR_Agg2Bc2agu4	HP
2782	BR_Agg2Bc2agu5	HP
2783	BR_Agg4Bc1grv1lp	HP
2784	BR_Agg4Bc1grv2lp	HP
2785	BR_Agg4Bc1grv3lp	HP
2786	BR_Agg4Bc1grv4lp	HP
2787	BR_Agg4Bc1grv5lp	HP
2788	BR_Agg4Bc4agu1lp	HP
2789	BR_Agg4Bc4agu2lp	HP
2790	BR_Agg4Bc4agu3lp	HP
2791	BR_Agg4Bc4agu4lp	HP
2792	BR_Agg4Bc4agu5lp	HP
2793	BR_Agg4Bc21lp	HP
2794	BR_Agg4Bc22lp	HP
2795	BR_Agg4Bc23lp	HP
2796	BR_Agg4Bc24lp	HP
2797	BR_Agg4Bc25lp	HP
2798	BR_Agg4Bc31lp	HP
2799	BR_Agg4Bc32lp	HP
2800	BR_Agg4Bc33lp	HP
2801	BR_Agg4Bc34lp	HP
2802	BR_Agg4Bc35lp	HP
2803	BR_AggMad1grv1	HP
2804	BR_AggMad1grv2	HP
2805	BR_AggMad1grv3	HP
2806	BR_AggMad1grv4	HP
2807	BR_AggMad1grv5	HP
2808	BR_AggMad2agu1	HP
2809	BR_AggMad2agu2	HP
2810	BR_AggMad2agu3	HP
2811	BR_AggMad2agu4	HP
2812	BR_AggMad2agu5	HP
2813	BR_AlfaiaBqt1	LP
2814	BR_AlfaiaBqt2	LP

#	Drum Sample	DF
2815	BR_AlfaiaBqt3	LP
2816	BR_AlfaiaBqt4	LP
2817	BR_AlfaiaCl1	LP
2818	BR_AlfaiaCl2	LP
2819	BR_AlfaiaCl3	LP
2820	BR_AlfaiaCl4	LP
2821	BR_AlfaiaOp1	LP
2822	BR_AlfaiaOp2	LP
2823	BR_AlfaiaOp3	LP
2824	BR_AlfaiaOp4	LP
2825	BR_ApitoA	HP
2826	BR_ApitoB	HP
2827	BR_ApitoC	HP
2828	BR_CaxixiAAnsw_f	HP
2829	BR_CaxixiAAnsw_p	HP
2830	BR_CaxixiAQues_f	HP
2831	BR_CaxixiAQues_p	HP
2832	BR_CaxixiBAnsw_f	HP
2833	BR_CaxixiBAnsw_p	HP
2834	BR_CaxixiBQues_f	HP
2835	BR_CaxixiBQues_p	HP
2836	BR_ChocalhoAnsw	HP
2837	BR_ChocalhoQues	HP
2838	BR_CuicaAgu1	LP
2839	BR_CuicaAgu2	LP
2840	BR_CuicaAgu3	LP
2841	BR_CuicaGrvA1	LP
2842	BR_CuicaGrvA2	LP
2843	BR_CuicaGrvA3	LP
2844	BR_CuicaGrvB1	LP
2845	BR_CuicaGrvB2	LP
2846	BR_CuicaGrvB3	LP
2847	BR_CuicaGrvC1	LP
2848	BR_CuicaGrvC2	LP

#	Drum Sample	DF
2849	BR_CuicaGrvC3	LP
2850	BR_CuicaMedA1	LP
2851	BR_CuicaMedA2	LP
2852	BR_CuicaMedA3	LP
2853	BR_CuicaMedB1	LP
2854	BR_CuicaMedB2	LP
2855	BR_CuicaMedB3	LP
2856	BR_FrigidBorda1	HP
2857	BR_FrigidBorda2	HP
2858	BR_FrigidBorda3	HP
2859	BR_FrigidBorda4	HP
2860	BR_FrigidCentro1	HP
2861	BR_FrigidCentro2	HP
2862	BR_FrigidCentro3	HP
2863	BR_FrigidCentro4	HP
2864	BR_GanzaAnsw_f	HP
2865	BR_GanzaAnsw_p	HP
2866	BR_GanzaQues_f	HP
2867	BR_GanzaQues_p	HP
2868	BR_Gongue1	HP
2869	BR_Gongue2	HP
2870	BR_Gongue3	HP
2871	BR_Gongue4	HP
2872	BR_Gongue5	HP
2873	BR_MatchbFng1	LP
2874	BR_MatchbFng2	LP
2875	BR_MatchbFng3	LP
2876	BR_MatchbFng4	LP
2877	BR_PndCocoCls1	LP
2878	BR_PndCocoCls2	LP
2879	BR_PndCocoCls3	LP
2880	BR_PndCocoCls4	LP
2881	BR_PndCocoCls5	LP
2882	BR_PndCocoDeepMt1	LP

#	Drum Sample	DF
2883	BR_PndCocoDeepMt2	LP
2884	BR_PndCocoDeepMt3	LP
2885	BR_PndCocoDeepMt4	LP
2886	BR_PndCocoDeepMt5	LP
2887	BR_PndCocoOpn1	LP
2888	BR_PndCocoOpn2	LP
2889	BR_PndCocoOpn3	LP
2890	BR_PndCocoOpn4	LP
2891	BR_PndCocoPlt1	LP
2892	BR_PndCocoPlt2	LP
2893	BR_PndCocoPlt3	LP
2894	BR_PndCocoPlt4	LP
2895	BR_PndCocoPlt5	LP
2896	BR_PndCocoRuloLong	LP
2897	BR_PndCocoRuloShort	LP
2898	BR_PndCocoSlap1	LP
2899	BR_PndCocoSlap2	LP
2900	BR_PndCocoSlap3	LP
2901	BR_PndCouroCls1	LP
2902	BR_PndCouroCls2	LP
2903	BR_PndCouroCls3	LP
2904	BR_PndCouroCls4	LP
2905	BR_PndCouroCls5	LP
2906	BR_PndCouroDeepMt1	LP
2907	BR_PndCouroDeepMt2	LP
2908	BR_PndCouroDeepMt3	LP
2909	BR_PndCouroDeepMt4	LP
2910	BR_PndCouroOpn1	LP
2911	BR_PndCouroOpn2	LP
2912	BR_PndCouroOpn3	LP
2913	BR_PndCouroOpn4	LP
2914	BR_PndCouroPlt1	LP
2915	BR_PndCouroPlt2	LP
2916	BR_PndCouroPlt3	LP

#	Drum Sample	DF
2917	BR_PndCouroPlt4	LP
2918	BR_PndCouroPlt5	LP
2919	BR_PndCouroPltOnly1	LP
2920	BR_PndCouroPltOnly2	LP
2921	BR_PndCouroRuloLong	LP
2922	BR_PndCouroRuloMedium	LP
2923	BR_PndCouroRuloShort	LP
2924	BR_PndCouroSlap1	LP
2925	BR_PndCouroSlap2	LP
2926	BR_PndCouroSlap3	LP
2927	BR_PndCouroSlap4	LP
2928	BR_PndNylonCls1	LP
2929	BR_PndNylonCls2	LP
2930	BR_PndNylonCls3	LP
2931	BR_PndNylonCls4	LP
2932	BR_PndNylonCls5	LP
2933	BR_PndNylonOpn1	LP
2934	BR_PndNylonOpn2	LP
2935	BR_PndNylonOpn3	LP
2936	BR_PndNylonOpn4	LP
2937	BR_PndNylonOpn5	LP
2938	BR_PndNylonPlt1	LP
2939	BR_PndNylonPlt2	LP
2940	BR_PndNylonPlt3	LP
2941	BR_PndNylonPlt4	LP
2942	BR_PndNylonPlt5	LP
2943	BR_PndNylonRuloLong	LP
2944	BR_PndNylonRuloMedium	LP
2945	BR_PndNylonRuloShort	LP
2946	BR_PndNylonSlap1	LP
2947	BR_PndNylonSlap2	LP
2948	BR_PndNylonSlap3	LP
2949	BR_PndNylonSlap4	LP
2950	BR_PndNylonSlap5	LP

#	Drum Sample	DF
2951	BR_PndTradCls1	LP
2952	BR_PndTradCls2	LP
2953	BR_PndTradCls3	LP
2954	BR_PndTradCls4	LP
2955	BR_PndTradCls5	LP
2956	BR_PndTradOpn1	LP
2957	BR_PndTradOpn2	LP
2958	BR_PndTradOpn3	LP
2959	BR_PndTradOpn4	LP
2960	BR_PndTradOpn5	LP
2961	BR_PndTradPlat1	LP
2962	BR_PndTradPlat2	LP
2963	BR_PndTradPlat3	LP
2964	BR_PndTradPlat4	LP
2965	BR_PndTradPlat5	LP
2966	BR_PndTradRuloLong	LP
2967	BR_PndTradRuloShort	LP
2968	BR_PndTradSlap1	LP
2969	BR_PndTradSlap2	LP
2970	BR_PndTradSlap3	LP
2971	BR_PndTradSlap4	LP
2972	BR_PratoHit1	HP
2973	BR_PratoHit2	HP
2974	BR_PratoHit3	HP
2975	BR_PratoSlide1	HP
2976	BR_PratoSlide2	HP
2977	BR_PratoSlide3	HP
2978	BR_RecoHitA1	HP
2979	BR_RecoHitA2	HP
2980	BR_RecoHitA3	HP
2981	BR_RecoHitA4	HP
2982	BR_RecoHitA5	HP
2983	BR_RecoHitB1	HP
2984	BR_RecoHitB2	HP

#	Drum Sample	DF
2985	BR_RecoHitB3	HP
2986	BR_RecoHitB4	HP
2987	BR_RecoHitB5	HP
2988	BR_RecoSlideA1	HP
2989	BR_RecoSlideA2	HP
2990	BR_RecoSlideA3	HP
2991	BR_RecoSlideA4	HP
2992	BR_RecoSlideA5	HP
2993	BR_RecoSlideB1	HP
2994	BR_RecoSlideB2	HP
2995	BR_RecoSlideB3	HP
2996	BR_RecoSlideB4	HP
2997	BR_RecoSlideB5	HP
2998	BR_RecoSlideLn1	HP
2999	BR_RecoSlideLn2	HP
3000	BR_RecoSlideMd1	HP
3001	BR_RecoSlideMd2	HP
3002	BR_RecoSlideMd3	HP
3003	BR_RecoSlideMd4	HP
3004	BR_RecoSlideMd5	HP
3005	BR_RpnqMtMad1	LP
3006	BR_RpnqMtMad2	LP
3007	BR_RpnqMtMad3	LP
3008	BR_RpnqMtMad4	LP
3009	BR_RpnqMtNyl1	LP
3010	BR_RpnqMtNyl2	LP
3011	BR_RpnqMtNyl3	LP
3012	BR_RpnqMtNyl4	LP
3013	BR_RpnqMtVim1	LP
3014	BR_RpnqMtVim2	LP
3015	BR_RpnqMtVim3	LP
3016	BR_RpnqMtVim4	LP
3017	BR_RpnqRimMad1	LP
3018	BR_RpnqRimMad2	LP

#	Drum Sample	DF
3019	BR_RpnqRimMad3	LP
3020	BR_RpnqRimMad4	LP
3021	BR_RpnqRimNyl1	LP
3022	BR_RpnqRimNyl2	LP
3023	BR_RpnqRimNyl3	LP
3024	BR_RpnqRimNyl4	LP
3025	BR_RpnqRimVim1	LP
3026	BR_RpnqRimVim2	LP
3027	BR_RpnqRimVim3	LP
3028	BR_RpnqRimVim4	LP
3029	BR_RpqAnelHndMt1	LP
3030	BR_RpqAnelHndMt2	LP
3031	BR_RpqAnelHndMt3	LP
3032	BR_RpqAnelHndMt4	LP
3033	BR_RpqAnelOpn1	LP
3034	BR_RpqAnelOpn2	LP
3035	BR_RpqAnelOpn3	LP
3036	BR_RpqAnelOpn4	LP
3037	BR_RpqAnelRpq1	LP
3038	BR_RpqAnelRpq2	LP
3039	BR_RpqAnelRpq3	LP
3040	BR_RpqAnelRpq4	LP
3041	BR_SmbSnr1Opn1	SD
3042	BR_SmbSnr1Opn2	SD
3043	BR_SmbSnr1Opn3	SD
3044	BR_SmbSnr1Opn4	SD
3045	BR_SmbSnr1Rim1	SD
3046	BR_SmbSnr1Rim2	SD
3047	BR_SmbSnr1Rim3	SD
3048	BR_SmbSnr1Rim4	SD
3049	BR_SmbSnr1RII1	SD
3050	BR_SmbSnr1RII2	SD
3051	BR_SmbSnr1RII3	SD
3052	BR_SmbSnr1RII4	SD

#	Drum Sample	DF
3053	BR_SmbSnr2Opn1	SD
3054	BR_SmbSnr2Opn2	SD
3055	BR_SmbSnr2Opn3	SD
3056	BR_SmbSnr2Opn4	SD
3057	BR_SmbSnr2Rim1	SD
3058	BR_SmbSnr2Rim2	SD
3059	BR_SmbSnr2Rim3	SD
3060	BR_SmbSnr2Rim4	SD
3061	BR_SmbSnr2RII1	SD
3062	BR_SmbSnr2RII2	SD
3063	BR_SmbSnr2RII3	SD
3064	BR_SmbSnr2RII4	SD
3065	BR_SmbSnr3Opn1	SD
3066	BR_SmbSnr3Opn2	SD
3067	BR_SmbSnr3Opn3	SD
3068	BR_SmbSnr3Opn4	SD
3069	BR_SmbSnr3Rim1	SD
3070	BR_SmbSnr3Rim2	SD
3071	BR_SmbSnr3Rim3	SD
3072	BR_SmbSnr3Rim4	SD
3073	BR_SmbSnr3RII1	SD
3074	BR_SmbSnr3RII2	SD
3075	BR_SmbSnr3RII3	SD
3076	BR_SmbSnr3RII4	SD
3077	BR_SrdPriHandMt1	LP
3078	BR_SrdPriHandMt2	LP
3079	BR_SrdPriHandMt3	LP
3080	BR_SrdPriHandMt4	LP
3081	BR_SrdPriMt1	LP
3082	BR_SrdPriMt2	LP
3083	BR_SrdPriMt3	LP
3084	BR_SrdPriMt4	LP
3085	BR_SrdPriMtBqtCI1	LP
3086	BR_SrdPriMtBqtCI2	LP

#	Drum Sample	DF
3087	BR_SrdPriMtBqtCI3	LP
3088	BR_SrdPriMtBqtCI4	LP
3089	BR_SrdPriOp1	LP
3090	BR_SrdPriOp2	LP
3091	BR_SrdPriOp3	LP
3092	BR_SrdPriOp4	LP
3093	BR_SrdQuaCI1	LP
3094	BR_SrdQuaCI2	LP
3095	BR_SrdQuaCI3	LP
3096	BR_SrdQuaCI4	LP
3097	BR_SrdQuaHandMt1	LP
3098	BR_SrdQuaHandMt2	LP
3099	BR_SrdQuaHandMt3	LP
3100	BR_SrdQuaHandMt4	LP
3101	BR_SrdQuaOp1	LP
3102	BR_SrdQuaOp2	LP
3103	BR_SrdQuaOp3	LP
3104	BR_SrdQuaOp4	LP
3105	BR_SrdSegHandMt1	LP
3106	BR_SrdSegHandMt2	LP
3107	BR_SrdSegHandMt3	LP
3108	BR_SrdSegHandMt4	LP
3109	BR_SrdSegMtBqtCI1	LP
3110	BR_SrdSegMtBqtCI2	LP
3111	BR_SrdSegMtBqtCI3	LP
3112	BR_SrdSegMtBqtCI4	LP
3113	BR_SrdSegOp1	LP
3114	BR_SrdSegOp2	LP
3115	BR_SrdSegOp3	LP
3116	BR_SrdSegOp4	LP
3117	BR_SrdTerHandMt1	LP
3118	BR_SrdTerHandMt2	LP
3119	BR_SrdTerHandMt3	LP
3120	BR_SrdTerHandMt4	LP

#	Drum Sample	DF
3121	BR_SrdTerMtBqtCl1	LP
3122	BR_SrdTerMtBqtCl2	LP
3123	BR_SrdTerMtBqtCl3	LP
3124	BR_SrdTerMtBqtCl4	LP
3125	BR_SrdTerOp1	LP
3126	BR_SrdTerOp2	LP
3127	BR_SrdTerOp3	LP
3128	BR_SrdTerOp4	LP
3129	BR_Tamborica1	LP
3130	BR_Tamborica2	LP
3131	BR_Tamborica3	LP
3132	BR_Tamborica4	LP
3133	BR_TamzaoFngMt1	LP
3134	BR_TamzaoFngMt2	LP
3135	BR_TamzaoFngMt3	LP
3136	BR_TamzaoFngMt4	LP
3137	BR_TamzaoFngMt5	LP
3138	BR_TamzaoHndMt1	LP
3139	BR_TamzaoHndMt2	LP
3140	BR_TamzaoHndMt3	LP
3141	BR_TamzaoHndMt4	LP
3142	BR_TamzaoHndMt5	LP
3143	BR_TamzaoLatat1	LP
3144	BR_TamzaoLatat2	LP
3145	BR_TamzaoLatat3	LP
3146	BR_TamzaoLatat4	LP
3147	BR_TamzaoLatat5	LP
3148	BR_TamzaoOpenA1	LP
3149	BR_TamzaoOpenA2	LP
3150	BR_TamzaoOpenA3	LP
3151	BR_TamzaoOpenA4	LP
3152	BR_TamzaoOpenA5	LP
3153	BR_TamzinHndMt1	LP
3154	BR_TamzinHndMt2	LP

#	Drum Sample	DF
3155	BR_TamzinHndMt3	LP
3156	BR_TamzinHndMt4	LP
3157	BR_TamzinHndSlp1	LP
3158	BR_TamzinHndSlp2	LP
3159	BR_TamzinHndSlp3	LP
3160	BR_TamzinHndSlp4	LP
3161	BR_TamzinOpen1	LP
3162	BR_TamzinOpen2	LP
3163	BR_TamzinOpen3	LP
3164	BR_TamzinOpen4	LP
3165	BR_TamzinShell1	LP
3166	BR_TamzinShell2	LP
3167	BR_TamzinShell3	LP
3168	BR_TamzinShell4	LP
3169	BR_TimbaHiMaoFec1	LP
3170	BR_TimbaHiMaoFec2	LP
3171	BR_TimbaHiMaoFec3	LP
3172	BR_TimbaHiMaoFec4	LP
3173	BR_TimbaHiVas1	LP
3174	BR_TimbaHiVas2	LP
3175	BR_TimbaHiVas3	LP
3176	BR_TimbaHiVas4	LP
3177	BR_TimbaLoFng1	LP
3178	BR_TimbaLoFng2	LP
3179	BR_TimbaLoFng3	LP
3180	BR_TimbaLoFng4	LP
3181	BR_TimbaLoOpn1	LP
3182	BR_TimbaLoOpn2	LP
3183	BR_TimbaLoOpn3	LP
3184	BR_TimbaLoOpn4	LP
3185	BR_TimbauLoBs	LP
3186	BR_TimbauToBs1	LP
3187	BR_TimbauToBs2	LP
3188	BR_TimbauToBs3	LP

#	Drum Sample	DF
3189	BR_TimbauToOpFlm1	LP
3190	BR_TimbauToOpFlm2	LP
3191	BR_TimbauToOpFlm3	LP
3192	BR_TmbUpstr1	LP
3193	BR_TmbUpstr2	LP
3194	BR_TmbUpstr3	LP
3195	BR_TmbUpstr4	LP
3196	BR_TmbUpstr5	LP
3197	BR_TrianguloCl1	HP
3198	BR_TrianguloCl2	HP
3199	BR_TrianguloCl3	HP
3200	BR_TrianguloOp1lp	HP
3201	BR_TrianguloOp2lp	HP
3202	BR_TrianguloOp3lp	HP
3203	BR_WdTmbDmpFng1	LP
3204	BR_WdTmbDmpFng2	LP
3205	BR_WdTmbDmpFng3	LP
3206	BR_WdTmbDmpFng4	LP
3207	BR_WdTmbDmpFng5	LP
3208	BR_WdTmbOpnA1	LP
3209	BR_WdTmbOpnA2	LP
3210	BR_WdTmbOpnA3	LP
3211	BR_WdTmbOpnA4	LP
3212	BR_WdTmbOpnB1	LP
3213	BR_WdTmbOpnB2	LP
3214	BR_WdTmbOpnB3	LP
3215	BR_WdTmbOpnB4	LP
3216	BR_WdTmbRm1	LP
3217	BR_WdTmbRm2	LP
3218	BR_WdTmbRm3	LP
3219	BR_WdTmbRm4	LP
3220	BR_ZabuBotBacCl1	LP
3221	BR_ZabuBotBacCl2	LP
3222	BR_ZabuBotBacCl3	LP

#	Drum Sample	DF
3223	BR_ZabuBotBacCl4	LP
3224	BR_ZabuBotCl1	LP
3225	BR_ZabuBotCl2	LP
3226	BR_ZabuBotCl3	LP
3227	BR_ZabuBotCl4	LP
3228	BR_ZabuBotGrvOp1	LP
3229	BR_ZabuBotGrvOp2	LP
3230	BR_ZabuBotGrvOp3	LP
3231	BR_ZabuBotGrvOp4	LP
3232	BR_ZabuTopBacCl1	LP
3233	BR_ZabuTopBacCl2	LP
3234	BR_ZabuTopBacCl3	LP
3235	BR_ZabuTopBacCl4	LP
3236	BR_ZabuTopCl1	LP
3237	BR_ZabuTopCl2	LP
3238	BR_ZabuTopCl3	LP
3239	BR_ZabuTopCl4	LP
3240	BR_ZabuTopGrvOp1	LP
3241	BR_ZabuTopGrvOp2	LP
3242	BR_ZabuTopGrvOp3	LP
3243	BR_ZabuTopGrvOp4	LP
3244	BR_ZabuTopOp1	LP
3245	BR_ZabuTopOp2	LP
3246	BR_ZabuTopOp3	LP
3247	BR_ZabuTopOp4	LP
3248	Empty	-
3249	BD WFB24 1	BD
3250	BD WFB24 2	BD
3251	BD WFB24 3	BD
3252	BD WFB24 4	BD
3253	BD WFB24 5	BD
3254	BD WFB24 6	BD
3255	BD WFB24 7	BD
3256	BD WFB24 8	BD

#	Drum Sample	DF
3257	BD WFB22 1	BD
3258	BD WFB22 2	BD
3259	BD WFB22 3	BD
3260	BD WFB22 4	BD
3261	BD WFB22 5	BD
3262	BD WFB22 6	BD
3263	BD WFB22 7	BD
3264	BD WFB22 8	BD
3265	BD WFB20 1	BD
3266	BD WFB20 2	BD
3267	BD WFB20 3	BD
3268	BD WFB20 4	BD
3269	BD WFB20 5	BD
3270	BD WFB20 6	BD
3271	BD WFB20 7	BD
3272	BD WFB20 8	BD
3273	BD CRB24 1	BD
3274	BD CRB24 2	BD
3275	BD CRB24 3	BD
3276	BD CRB24 4	BD
3277	BD CRB24 5	BD
3278	BD CRB24 6	BD
3279	BD CRB24 7	BD
3280	BD CRB24 8	BD
3281	BD CRB22 1	BD
3282	BD CRB22 2	BD
3283	BD CRB22 3	BD
3284	BD CRB22 4	BD
3285	BD CRB22 5	BD
3286	BD CRB22 6	BD
3287	BD CRB22 7	BD
3288	BD CRB22 8	BD
3289	BD MCX22 C 1	BD
3290	BD MCX22 C 2	BD

#	Drum Sample	DF
3291	BD MCX22 C 3	BD
3292	BD MCX22 C 4	BD
3293	BD MCX22 C 5	BD
3294	BD MCX22 C 6	BD
3295	BD MCX22 C 7	BD
3296	BD MCX22 C 8	BD
3297	BD MCX22 B 1	BD
3298	BD MCX22 B 2	BD
3299	BD MCX22 B 3	BD
3300	BD MCX22 B 4	BD
3301	BD MCX22 B 5	BD
3302	BD MCX22 B 6	BD
3303	BD MCX22 B 7	BD
3304	BD MCX22 B 8	BD
3305	BD MCP22 1	BD
3306	BD MCP22 2	BD
3307	BD MCP22 3	BD
3308	BD MCP22 4	BD
3309	BD MCP22 5	BD
3310	BD MCP22 6	BD
3311	BD MCP22 7	BD
3312	BD MCP22 8	BD
3313	BD RFP22 1	BD
3314	BD RFP22 2	BD
3315	BD RFP22 3	BD
3316	BD RFP22 4	BD
3317	BD RFP22 5	BD
3318	BD RFP22 6	BD
3319	BD RFP22 7	BD
3320	BD RFP22 8	BD
3321	BD RFR20 1	BD
3322	BD RFR20 2	BD
3323	BD RFR20 3	BD
3324	BD RFR20 4	BD

#	Drum Sample	DF
3325	BD RFR20 5	BD
3326	BD RFR20 6	BD
3327	BD RFR20 7	BD
3328	BD RFR20 8	BD
3329	BD GGD20 1	BD
3330	BD GGD20 2	BD
3331	BD GGD20 3	BD
3332	BD GGD20 4	BD
3333	BD GGD20 5	BD
3334	BD GGD20 6	BD
3335	BD GGD20 7	BD
3336	BD GGD20 8	BD
3337	BD RFR18 1	BD
3338	BD RFR18 2	BD
3339	BD RFR18 3	BD
3340	BD RFR18 4	BD
3341	BD RFR18 5	BD
3342	BD RFR18 6	BD
3343	BD RFR18 7	BD
3344	SD SPM15 C 1	SD
3345	SD SPM15 C 2	SD
3346	SD SPM15 C 3	SD
3347	SD SPM15 C 4	SD
3348	SD SPM15 C 5	SD
3349	SD SPM15 C 6	SD
3350	SD SPM15 C 7	SD
3351	SD SPM15 C 8	SD
3352	SD SPM15 E 1	SD
3353	SD SPM15 E 2	SD
3354	SD SPM15 E 3	SD
3355	SD SPM15 E 4	SD
3356	SD SPM15 E 5	SD
3357	SD SPM15 E 6	SD
3358	SD SPM15 E 7	SD

#	Drum Sample	DF
3359	SD SPM15 E 8	SD
3360	SD SPM15 R 1	SD
3361	SD SPM15 R 2	SD
3362	SD SPM15 R 3	SD
3363	SD Ref14 C 1	SD
3364	SD Ref14 C 2	SD
3365	SD Ref14 C 3	SD
3366	SD Ref14 C 4	SD
3367	SD Ref14 C 5	SD
3368	SD Ref14 C 6	SD
3369	SD Ref14 C 7	SD
3370	SD Ref14 C 8	SD
3371	SD Ref14 E 1	SD
3372	SD Ref14 E 2	SD
3373	SD Ref14 E 3	SD
3374	SD Ref14 E 4	SD
3375	SD Ref14 E 5	SD
3376	SD Ref14 E 6	SD
3377	SD Ref14 E 7	SD
3378	SD Ref14 E 8	SD
3379	SD Ref14 R 1	SD
3380	SD Ref14 R 2	SD
3381	SD Ref14 R 3	SD
3382	SD KFG14 CS 1	SD
3383	SD KFG14 CS 2	SD
3384	SD KFG14 CS 3	SD
3385	SD KFG14 C 1	SD
3386	SD KFG14 C 2	SD
3387	SD KFG14 C 3	SD
3388	SD KFG14 C 4	SD
3389	SD KFG14 C 5	SD
3390	SD KFG14 C 6	SD
3391	SD KFG14 C 7	SD
3392	SD KFG14 C 8	SD

#	Drum Sample	DF
3393	SD KFG14 E 1	SD
3394	SD KFG14 E 2	SD
3395	SD KFG14 E 3	SD
3396	SD KFG14 E 4	SD
3397	SD KFG14 E 5	SD
3398	SD KFG14 E 6	SD
3399	SD KFG14 E 7	SD
3400	SD KFG14 E 8	SD
3401	SD KFG14 R 1	SD
3402	SD KFG14 R 2	SD
3403	SD KFG14 R 3	SD
3404	SD DCA14 C 1	SD
3405	SD DCA14 C 2	SD
3406	SD DCA14 C 3	SD
3407	SD DCA14 C 4	SD
3408	SD DCA14 C 5	SD
3409	SD DCA14 C 6	SD
3410	SD DCA14 C 7	SD
3411	SD DCA14 C 8	SD
3412	SD DCA14 R 1	SD
3413	SD DCA14 R 2	SD
3414	SD DCA14 R 3	SD
3415	SD DCA14 E 1	SD
3416	SD DCA14 E 2	SD
3417	SD DCA14 E 3	SD
3418	SD DCA14 E 4	SD
3419	SD DCA14 E 5	SD
3420	SD DCA14 E 6	SD
3421	SD DCA14 E 7	SD
3422	SD DCA14 E 8	SD
3423	SD FFP14 C 1	SD
3424	SD FFP14 C 2	SD
3425	SD FFP14 C 3	SD
3426	SD FFP14 C 4	SD

#	Drum Sample	DF
3427	SD FFP14 C 5	SD
3428	SD FFP14 C 6	SD
3429	SD FFP14 C 7	SD
3430	SD FFP14 C 8	SD
3431	SD FFP14 E 1	SD
3432	SD FFP14 E 2	SD
3433	SD FFP14 E 3	SD
3434	SD FFP14 E 4	SD
3435	SD FFP14 E 5	SD
3436	SD FFP14 E 6	SD
3437	SD FFP14 E 7	SD
3438	SD FFP14 E 8	SD
3439	SD FFP14 R 1	SD
3440	SD FFP14 R 2	SD
3441	SD FFP14 R 3	SD
3442	SD MCX14 C 1	SD
3443	SD MCX14 C 2	SD
3444	SD MCX14 C 3	SD
3445	SD MCX14 C 4	SD
3446	SD MCX14 C 5	SD
3447	SD MCX14 C 6	SD
3448	SD MCX14 C 7	SD
3449	SD MCX14 C 8	SD
3450	SD MCX14 E 1	SD
3451	SD MCX14 E 2	SD
3452	SD MCX14 E 3	SD
3453	SD MCX14 E 4	SD
3454	SD MCX14 E 5	SD
3455	SD MCX14 E 6	SD
3456	SD MCX14 E 7	SD
3457	SD MCX14 E 8	SD
3458	SD MCX14 R 1	SD
3459	SD MCX14 R 2	SD
3460	SD MCX14 R 3	SD

#	Drum Sample	DF
3461	SD BCX14 C 1	SD
3462	SD BCX14 C 2	SD
3463	SD BCX14 C 3	SD
3464	SD BCX14 C 4	SD
3465	SD BCX14 C 5	SD
3466	SD BCX14 C 6	SD
3467	SD BCX14 C 7	SD
3468	SD BCX14 C 8	SD
3469	SD BCX14 E 1	SD
3470	SD BCX14 E 2	SD
3471	SD BCX14 E 3	SD
3472	SD BCX14 E 4	SD
3473	SD BCX14 E 5	SD
3474	SD BCX14 E 6	SD
3475	SD BCX14 E 7	SD
3476	SD BCX14 E 8	SD
3477	SD BCX14 R 1	SD
3478	SD BCX14 R 2	SD
3479	SD BCX14 R 3	SD
3480	SD SSC14 C 1	SD
3481	SD SSC14 C 2	SD
3482	SD SSC14 C 3	SD
3483	SD SSC14 C 4	SD
3484	SD SSC14 C 5	SD
3485	SD SSC14 C 6	SD
3486	SD SSC14 C 7	SD
3487	SD SSC14 C 8	SD
3488	SD SSC14 E 1	SD
3489	SD SSC14 E 2	SD
3490	SD SSC14 E 3	SD
3491	SD SSC14 E 4	SD
3492	SD SSC14 E 5	SD
3493	SD SSC14 E 6	SD
3494	SD SSC14 E 7	SD

#	Drum Sample	DF
3495	SD SSC14 E 8	SD
3496	SD SSC14 R 1	SD
3497	SD SSC14 R 2	SD
3498	SD SSC14 R 3	SD
3499	SD FFM14 C 1	SD
3500	SD FFM14 C 2	SD
3501	SD FFM14 C 3	SD
3502	SD FFM14 C 4	SD
3503	SD FFM14 C 5	SD
3504	SD FFM14 C 6	SD
3505	SD FFM14 C 7	SD
3506	SD FFM14 C 8	SD
3507	SD FFM14 E 1	SD
3508	SD FFM14 E 2	SD
3509	SD FFM14 E 3	SD
3510	SD FFM14 E 4	SD
3511	SD FFM14 E 5	SD
3512	SD FFM14 E 6	SD
3513	SD FFM14 E 7	SD
3514	SD FFM14 E 8	SD
3515	SD FFM14 R 8	SD
3516	SD RFW13 C 1	SD
3517	SD RFW13 C 2	SD
3518	SD RFW13 C 3	SD
3519	SD RFW13 C 4	SD
3520	SD RFW13 C 5	SD
3521	SD RFW13 C 6	SD
3522	SD RFW13 C 7	SD
3523	SD RFW13 C 8	SD
3524	SD RFW13 E 1	SD
3525	SD RFW13 E 2	SD
3526	SD RFW13 E 3	SD
3527	SD RFW13 E 4	SD
3528	SD RFW13 E 5	SD

#	Drum Sample	DF
3529	SD RFW13 E 6	SD
3530	SD RFW13 E 7	SD
3531	SD RFW13 E 8	SD
3532	SD RFW13 R 1	SD
3533	SD RFW13 R 2	SD
3534	SD RFW13 R 3	SD
3535	SD SPS13 C 1	SD
3536	SD SPS13 C 2	SD
3537	SD SPS13 C 3	SD
3538	SD SPS13 C 4	SD
3539	SD SPS13 C 5	SD
3540	SD SPS13 C 6	SD
3541	SD SPS13 C 7	SD
3542	SD SPS13 C 8	SD
3543	SD SPS13 E 1	SD
3544	SD SPS13 E 2	SD
3545	SD SPS13 E 3	SD
3546	SD SPS13 E 4	SD
3547	SD SPS13 E 5	SD
3548	SD SPS13 E 6	SD
3549	SD SPS13 E 7	SD
3550	SD SPS13 E 8	SD
3551	SD SPS13 R 1	SD
3552	SD SPS13 R 2	SD
3553	SD SPS13 R 3	SD
3554	Rim SPM15 1	SD
3555	Rim SPM15 2	SD
3556	Rim SPM15 3	SD
3557	Rim Ref14 1	SD
3558	Rim Ref14 2	SD
3559	Rim Ref14 3	SD
3560	Rim Ref14 4	SD
3561	Rim DCA14 1	SD
3562	Rim DCA14 2	SD

#	Drum Sample	DF
3563	Rim DCA14 3	SD
3564	Rim FFP14 1	SD
3565	Rim FFP14 2	SD
3566	Rim FFP14 3	SD
3567	Rim MCX14 1	SD
3568	Rim MCX14 2	SD
3569	Rim MCX14 3	SD
3570	Rim BCX14 1	SD
3571	Rim BCX14 2	SD
3572	Rim BCX14 3	SD
3573	Rim SSC14 1	SD
3574	Rim SSC14 2	SD
3575	Rim SSC14 3	SD
3576	Rim FFM14 1	SD
3577	Rim FFM14 2	SD
3578	Rim FFM14 3	SD
3579	Rim RFW13 1	SD
3580	Rim RFW13 2	SD
3581	Rim RFW13 3	SD
3582	Tom MCX S1 1	TM
3583	Tom MCX S1 2	TM
3584	Tom MCX S1 3	TM
3585	Tom MCX S1 4	TM
3586	Tom MCX S1 5	TM
3587	Tom MCX S1 6	TM
3588	Tom MCX S1 7	TM
3589	Tom MCX S1 8	TM
3590	Tom MCX S2 1	TM
3591	Tom MCX S2 2	TM
3592	Tom MCX S2 3	TM
3593	Tom MCX S2 4	TM
3594	Tom MCX S2 5	TM
3595	Tom MCX S2 6	TM
3596	Tom MCX S2 7	TM

#	Drum Sample	DF
3597	Tom MCX S2 8	TM
3598	Tom MCX S3 1	TM
3599	Tom MCX S3 2	TM
3600	Tom MCX S3 3	TM
3601	Tom MCX S3 4	TM
3602	Tom MCX S3 5	TM
3603	Tom MCX S3 6	TM
3604	Tom MCX S3 7	TM
3605	Tom MCX S3 8	TM
3606	Tom MCX S4 1	TM
3607	Tom MCX S4 2	TM
3608	Tom MCX S4 3	TM
3609	Tom MCX S4 4	TM
3610	Tom MCX S4 5	TM
3611	Tom MCX S4 6	TM
3612	Tom MCX S4 7	TM
3613	Tom MCX S4 8	TM
3614	Tom MCX S5 1	TM
3615	Tom MCX S5 2	TM
3616	Tom MCX S5 3	TM
3617	Tom MCX S5 4	TM
3618	Tom MCX S5 5	TM
3619	Tom MCX S5 6	TM
3620	Tom MCX S5 7	TM
3621	Tom MCX S5 8	TM
3622	Tom MCX S6 1	TM
3623	Tom MCX S6 2	TM
3624	Tom MCX S6 3	TM
3625	Tom MCX S6 4	TM
3626	Tom MCX S6 5	TM
3627	Tom MCX S6 6	TM
3628	Tom MCX S6 7	TM
3629	Tom MCX S6 8	TM
3630	Tom RfJ S11	TM

#	Drum Sample	DF
3631	Tom RfJ S1 2	TM
3632	Tom RfJ S1 3	TM
3633	Tom RfJ S1 4	TM
3634	Tom RfJ S1 5	TM
3635	Tom RfJ S1 6	TM
3636	Tom RfJ S1 7	TM
3637	Tom RfJ S1 8	TM
3638	Tom RfJ S2 1	TM
3639	Tom RfJ S2 2	TM
3640	Tom RfJ S2 3	TM
3641	Tom RfJ S2 4	TM
3642	Tom RfJ S2 5	TM
3643	Tom RfJ S2 6	TM
3644	Tom RfJ S2 7	TM
3645	Tom RfJ S2 8	TM
3646	Tom RfJ S3 1	TM
3647	Tom RfJ S3 2	TM
3648	Tom RfJ S3 3	TM
3649	Tom RfJ S3 4	TM
3650	Tom RfJ S3 5	TM
3651	Tom RfJ S3 6	TM
3652	Tom RfJ S3 7	TM
3653	Tom RfJ S3 8	TM
3654	Tom RFP S11	TM
3655	Tom RFP S12	TM
3656	Tom RFP S13	TM
3657	Tom RFP S14	TM
3658	Tom RFP S15	TM
3659	Tom RFP S16	TM
3660	Tom RFP S17	TM
3661	Tom RFP S18	TM
3662	Tom RFP S2 1	TM
3663	Tom RFP S2 2	TM
3664	Tom RFP S2 3	TM

#	Drum Sample	DF
3665	Tom RFP S2 4	TM
3666	Tom RFP S2 5	TM
3667	Tom RFP S2 6	TM
3668	Tom RFP S2 7	TM
3669	Tom RFP S2 8	TM
3670	Tom RFP S3 1	TM
3671	Tom RFP S3 2	TM
3672	Tom RFP S3 3	TM
3673	Tom RFP S3 4	TM
3674	Tom RFP S3 5	TM
3675	Tom RFP S3 6	TM
3676	Tom RFP S3 7	TM
3677	Tom RFP S3 8	TM
3678	Tom RFP S4 1	TM
3679	Tom RFP S4 2	TM
3680	Tom RFP S4 3	TM
3681	Tom RFP S4 4	TM
3682	Tom RFP S4 5	TM
3683	Tom RFP S4 6	TM
3684	Tom RFP S4 7	TM
3685	Tom RFP S4 8	TM
3686	Tom RFP S5 1	TM
3687	Tom RFP S5 2	TM
3688	Tom RFP S5 3	TM
3689	Tom RFP S5 4	TM
3690	Tom RFP S5 5	TM
3691	Tom RFP S5 6	TM
3692	Tom RFP S5 7	TM
3693	Tom RFP S5 8	TM
3694	HH S CE 1	HH
3695	HH S CE 2	HH
3696	HH S CE 3	HH
3697	HH S CE 4	HH
3698	HH S CT 1	HH

#	Drum Sample	DF
3699	HH S CT 2	HH
3700	HH S CT 3	HH
3701	HH S CT 4	HH
3702	HH S TE 1	HH
3703	HH S TE 2	HH
3704	HH S TE 3	HH
3705	HH S TE 4	HH
3706	HH S TT 1	HH
3707	HH S TT 2	HH
3708	HH S TT 3	HH
3709	HH S TT 4	HH
3710	HH S OE1 1	HH
3711	HH S OE1 2	HH
3712	HH S OE1 3	HH
3713	HH S OE1 4	HH
3714	HH S OE2 1	HH
3715	HH S OE2 2	HH
3716	HH S OE2 3	HH
3717	HH S OE2 4	HH
3718	HH S OE3 1	HH
3719	HH S OE3 2	HH
3720	HH S OE3 3	HH
3721	HH S OE3 4	HH
3722	HH S OE4 1	HH
3723	HH S OE4 2	HH
3724	HH S OE4 3	HH
3725	HH S OE4 4	HH
3726	HH S OT5 1	HH
3727	HH S OT5 2	HH
3728	HH S OT5 3	HH
3729	HH S OT5 4	HH
3730	HH S OT3 1	HH
3731	HH S OT3 2	HH
3732	HH S OT3 3	HH

#	Drum Sample	DF
3733	HH S OT3 4	HH
3734	HH S OT4 1	HH
3735	HH S OT4 2	HH
3736	HH S OT4 3	HH
3737	HH S OT4 4	HH
3738	HH S OT0 1	HH
3739	HH S OT0 2	HH
3740	HH S OT0 3	HH
3741	HH S OT0 4	HH
3742	HH S OT1 1	HH
3743	HH S OT1 2	HH
3744	HH S OT1 3	HH
3745	HH S OT1 4	HH
3746	HH S OT2 1	HH
3747	HH S OT2 2	HH
3748	HH S OT2 3	HH
3749	HH S OT2 4	HH
3750	HH S FPO	HH
3751	HH S PC 1	HH
3752	HH S PC 2	HH
3753	HH S OE0 1	HH
3754	HH S OE0 2	HH
3755	HH S OE0 3	HH
3756	HH S OE0 4	HH
3757	HH S2 CE 1	HH
3758	HH S2 CE 2	HH
3759	HH S2 CE 3	HH
3760	HH S2 CE 4	HH
3761	HH S2 CT 1	HH
3762	HH S2 CT 2	HH
3763	HH S2 CT 3	HH
3764	HH S2 CT 4	HH
3765	HH S2 TE 1	HH
3766	HH S2 TE 2	HH

#	Drum Sample	DF
3767	HH S2 TE 3	HH
3768	HH S2 TE 4	HH
3769	HH S2 TE 5	HH
3770	HH S2 TE 6	HH
3771	HH S2 TE 7	HH
3772	HH S2 TE 8	HH
3773	HH S2 TT 1	HH
3774	HH S2 TT 2	HH
3775	HH S2 TT 3	HH
3776	HH S2 TT 4	HH
3777	HH S2 TT 5	HH
3778	HH S2 TT 6	HH
3779	HH S2 TT 7	HH
3780	HH S2 TT 8	HH
3781	HH S2 OE1 1	HH
3782	HH S2 OE1 2	HH
3783	HH S2 OE1 3	HH
3784	HH S2 OE1 4	HH
3785	HH S2 OE2 1	HH
3786	HH S2 OE2 2	HH
3787	HH S2 OE2 3	HH
3788	HH S2 OE2 4	HH
3789	HH S2 OE3 1	HH
3790	HH S2 OE3 2	HH
3791	HH S2 OE3 3	HH
3792	HH S2 OE3 4	HH
3793	HH S2 OE4 1	HH
3794	HH S2 OE4 2	HH
3795	HH S2 OE4 3	HH
3796	HH S2 OE4 4	HH
3797	HH S2 OT5 1	HH
3798	HH S2 OT5 2	HH
3799	HH S2 OT5 3	HH
3800	HH S2 OT5 4	HH

#	Drum Sample	DF
3801	HH S2 OT3 1	HH
3802	HH S2 OT3 2	HH
3803	HH S2 OT3 3	HH
3804	HH S2 OT3 4	HH
3805	HH S2 OT4 1	HH
3806	HH S2 OT4 2	HH
3807	HH S2 OT4 3	HH
3808	HH S2 OT4 4	HH
3809	HH S2 OT0 1	HH
3810	HH S2 OT0 2	HH
3811	HH S2 OT0 3	HH
3812	HH S2 OT0 4	HH
3813	HH S2 OT1 1	HH
3814	HH S2 OT1 2	HH
3815	HH S2 OT1 3	HH
3816	HH S2 OT1 4	HH
3817	HH S2 OT2 1	HH
3818	HH S2 OT2 2	HH
3819	HH S2 OT2 3	HH
3820	HH S2 OT2 4	HH
3821	HH S2 FPO 1	HH
3822	HH S2 FPO 2	HH
3823	HH S2 FPC 1	HH
3824	HH S2 FPC 2	HH
3825	HH S2 OE0 1	HH
3826	HH S2 OE0 2	HH
3827	HH S2 OE0 3	HH
3828	HH S2 OE0 4	HH
3829	HH Z CE 1	HH
3830	HH Z CE 2	HH
3831	HH Z CE 3	HH
3832	HH Z CE 4	HH
3833	HH Z CT 1	HH
3834	HH Z CT 2	HH

#	Drum Sample	DF
3835	HH Z CT 3	HH
3836	HH Z CT 4	HH
3837	HH Z TE 1	HH
3838	HH Z TE 2	HH
3839	HH Z TE 3	HH
3840	HH Z TE 4	HH
3841	HH Z TT 1	HH
3842	HH Z TT 2	HH
3843	HH Z TT 3	HH
3844	HH Z TT 4	HH
3845	HH Z OT0 1	HH
3846	HH Z OT0 2	HH
3847	HH Z OT0 3	HH
3848	HH Z OT0 4	HH
3849	HH Z OT2 1	HH
3850	HH Z OT2 2	HH
3851	HH Z OT2 3	HH
3852	HH Z OT2 4	HH
3853	HH Z OT4 1	HH
3854	HH Z OT4 2	HH
3855	HH Z OT4 3	HH
3856	HH Z OT4 4	HH
3857	HH Z OT5 1	HH
3858	HH Z OT5 2	HH
3859	HH Z OT5 3	HH
3860	HH Z OT5 4	HH
3861	HH Z OT3 1	HH
3862	HH Z OT3 2	HH
3863	HH Z OT3 3	HH
3864	HH Z OT3 4	HH
3865	HH Z OT1 1	HH
3866	HH Z OT1 2	HH
3867	HH Z OT1 3	HH
3868	HH Z OT1 4	HH

#	Drum Sample	DF
3869	HH Z OE0 1	HH
3870	HH Z OE0 2	HH
3871	HH Z OE0 3	HH
3872	HH Z OE0 4	HH
3873	HH Z OE1 1	HH
3874	HH Z OE1 2	HH
3875	HH Z OE1 3	HH
3876	HH Z OE1 4	HH
3877	HH Z OE2 1	HH
3878	HH Z OE2 2	HH
3879	HH Z OE2 3	HH
3880	HH Z OE2 4	HH
3881	HH Z OE3 1	HH
3882	HH Z OE3 2	HH
3883	HH Z OE3 3	HH
3884	HH Z OE3 4	HH
3885	HH Z OE4 1	HH
3886	HH Z OE4 2	HH
3887	HH Z OE4 3	HH
3888	HH Z OE4 4	HH
3889	HH Z FPO 1	HH
3890	HH Z FPO 2	HH
3891	HH Z PC 1	HH
3892	HH Z PC 2	HH
3893	HH Z PC 3	HH
3894	HH Z PC 4	HH
3895	Ride S BI 1	CY
3896	Ride S BI 2	CY
3897	Ride S BI 3	CY
3898	Ride S BI 4	CY
3899	Ride S Bw 1	CY
3900	Ride S Bw 2	CY
3901	Ride S Bw 3	CY
3902	Ride S Bw 4	CY

#	Drum Sample	DF
3903	Ride S Bw 5	CY
3904	Ride S Bw 6	CY
3905	Ride S Bw 7	CY
3906	Ride S Bw 8	CY
3907	Ride S Ed 1	CY
3908	Ride S Ed 2	CY
3909	Ride S Ed 3	CY
3910	Ride S Ed 4	CY
3911	Ride S BC 1	CY
3912	Ride S EC 1	CY
3913	Ride S2P BI 1	CY
3914	Ride S2P BI 2	CY
3915	Ride S2P BI 3	CY
3916	Ride S2P BI 4	CY
3917	Ride S2P Bw 1	CY
3918	Ride S2P Bw 2	CY
3919	Ride S2P Bw 3	CY
3920	Ride S2P Bw 4	CY
3921	Ride S2P Bw 5	CY
3922	Ride S2P Bw 6	CY
3923	Ride S2P Bw 7	CY
3924	Ride S2P Ed 1	CY
3925	Ride S2P Ed 2	CY
3926	Ride S2P Ed 3	CY
3927	Ride S2P Ed 4	CY
3928	Ride Z1 BI 1	CY
3929	Ride Z1 BI 2	CY
3930	Ride Z1 BI 3	CY
3931	Ride Z1 BI 4	CY
3932	Ride Z1 Bw 1	CY
3933	Ride Z1 Bw 2	CY
3934	Ride Z1 Bw 3	CY
3935	Ride Z1 Bw 4	CY
3936	Ride Z1 Bw 5	CY

#	Drum Sample	DF
3937	Ride Z1 Bw 6	CY
3938	Ride Z1 Bw 7	CY
3939	Ride Z1 Bw 8	CY
3940	Ride Z1 Ed 1	CY
3941	Ride Z1 Ed 2	CY
3942	Ride Z1 Ed 3	CY
3943	Ride Z1 Ed 4	CY
3944	Ride Z1 Ed 5	CY
3945	Ride Z2 Bl 1	CY
3946	Ride Z2 Bl 2	CY
3947	Ride Z2 Bl 3	CY
3948	Ride Z2 Bl 4	CY
3949	Ride Z2 Bw 1	CY
3950	Ride Z2 Bw 2	CY
3951	Ride Z2 Bw 3	CY
3952	Ride Z2 Bw 4	CY
3953	Ride Z2 Bw 5	CY
3954	Ride Z2 Bw 6	CY
3955	Ride Z2 Bw 7	CY
3956	Ride Z2 Bw 8	CY
3957	Ride Z2 Ed 1	CY
3958	Ride Z2 Ed 2	CY
3959	Ride Z2 Ed 3	CY
3960	Ride Z2 Ed 4	CY
3961	Crash S18 1	CY
3962	Crash S18 2	CY
3963	Crash S18 3	CY
3964	Crash S18 4	CY
3965	Crash S18 Ch	CY
3966	Crash S218 1	CY
3967	Crash S218 2	CY
3968	Crash S218 3	CY
3969	Crash S218 4	CY
3970	Crash S218 Ch	CY

#	Drum Sample	DF
3971	Crash S16 1	CY
3972	Crash S16 2	CY
3973	Crash S16 3	CY
3974	Crash S16 4	CY
3975	Crash S16 Ch	CY
3976	Crash S216 1	CY
3977	Crash S216 2	CY
3978	Crash S216 3	CY
3979	Crash S216 4	CY
3980	Crash S216 Ch	CY
3981	Crash ZLD S 18 1	CY
3982	Crash ZLD S 18 2	CY
3983	Crash ZLD S 18 3	CY
3984	Crash ZLD S 18 4	CY
3985	Crash ZLD S 18 Ch	CY
3986	Crash ZLD S 16 1	CY
3987	Crash ZLD S 16 2	CY
3988	Crash ZLD S 16 3	CY
3989	Crash ZLD S 16 4	CY
3990	Crash ZLD S 16 Ch	CY
3991	Splash S 1	CY
3992	Splash S 2	CY
3993	Splash S 3	CY
3994	Splash S 4	CY
3995	Splash C10 1	CY
3996	Splash C10 2	CY
3997	Splash C10 3	CY
3998	Splash C10 4	CY
3999	China S 1	CY
4000	China S 2	CY
4001	China S 3	CY
4002	China S 4	CY
4003	Cymbal Roll Fast	CY
4004	Mallet Roll f fast	CY

#	Drum Sample	DF
4005	Mallet Roll f Med	CY
4006	Mallet Roll f Slow	CY
4007	Mallet Roll p fast	CY
4008	Mallet Roll p Med	CY
4009	Mallet Roll p Slow	CY
4010	Cowbell 1E 1	HP
4011	Cowbell 1E 2	HP
4012	Cowbell 1E 3	HP
4013	Cowbell 1E 4	HP
4014	Cowbell 1B 1	HP
4015	Cowbell 1B 2	HP
4016	Cowbell 1B 3	HP
4017	Cowbell 1B 4	HP
4018	Clave P20 1	LP
4019	Clave P20 2	LP
4020	Clave P20 3	LP
4021	Clave P20 4	LP
4022	Clave P10 1	LP
4023	Clave P10 2	LP
4024	Clave P10 3	LP
4025	Clave P10 4	LP
4026	Shaker Off 1	HP
4027	Shaker Off 2	HP
4028	Shaker On 1	HP
4029	Shaker On 2	HP
4030	JL NuDub Kik 1	BD
4031	JL NuDub Kik 2	BD
4032	JL NuDub Kik 3	BD
4033	JL NuDub Kik 4	BD
4034	JL NuDub Kik 5	BD
4035	JL NuDub Kik 6	BD
4036	JL NuDub Kik 7	BD
4037	JL NuDub Kik 8	BD
4038	JL NuDub Kik 9	BD

#	Drum Sample	DF
4039	JL NuDub Kik 10	BD
4040	JL NuDub Kik 11	BD
4041	JL NuDub Kik 12	BD
4042	JL NuDub Kik 13	BD
4043	JL NuDub Kik 14	BD
4044	JL NuDub Kik 15	BD
4045	JL NuDub Kik 16	BD
4046	JL NuDub Kik 17	BD
4047	JL NuDub Kik 18	BD
4048	JL NuDub Kik 19	BD
4049	JL NuDub Kik 20	BD
4050	JL NuDub Kik 21	BD
4051	JL NuDub Snare 1	SD
4052	JL NuDub Snare 2	SD
4053	JL NuDub Snare 3	SD
4054	JL NuDub Snare 4	SD
4055	JL NuDub Snare 5	SD
4056	JL NuDub Snare 6	SD
4057	JL NuDub Snare 7	SD
4058	JL NuDub Snare 8	SD
4059	JL NuDub Snare 9	SD
4060	JL NuDub Snare 10	SD
4061	JL NuDub Snare 11	SD
4062	JL NuDub Snare 12	SD
4063	JL NuDub Snare 13	SD
4064	JL NuDub Snare 14	SD
4065	JL NuDub Snare 15	SD
4066	JL NuDub Snare 16	SD
4067	JL NuDub Snare 17	SD
4068	JL NuDub Snare 18	SD
4069	JL NuDub Snare 19	SD
4070	JL NuDub Snare 20	SD
4071	JL NuDub Snare 21	SD
4072	JL NuDub Snare 22	SD

#	Drum Sample	DF
4073	JL NuDub Snare 23	SD
4074	JL EDM Kik 1	BD
4075	JL EDM Kik 2	BD
4076	JL EDM Kik 3	BD
4077	JL EDM Kik 4	BD
4078	JL EDM Kik 5	BD
4079	JL EDM Kik 6	BD
4080	JL EDM Kik 7	BD
4081	JL EDM Kik 8	BD
4082	JL EDM Kik 9	BD
4083	JL EDM Kik 10	BD
4084	JL EDM Kik 11	BD
4085	JL EDM Kik 12	BD
4086	JL EDM Kik 13	BD
4087	JL EDM Kik 14	BD
4088	JL EDM Kik 15	BD
4089	JL EDM Kik 16	BD
4090	JL EDM Kik 17	BD
4091	JL EDM Kik 18	BD
4092	JL EDM Kik 19	BD
4093	JL EDM Kik 20	BD
4094	JL EDM Snare 1	SD
4095	JL EDM Snare 2	SD
4096	JL EDM Snare 3	SD
4097	JL EDM Snare 4	SD
4098	JL EDM Snare 5	SD
4099	JL EDM Snare 6	SD
4100	JL EDM Snare 7	SD
4101	JL EDM Snare 8	SD
4102	JL EDM Snare 9	SD
4103	JL EDM Snare 10	SD
4104	JL EDM Snare 11	SD
4105	JL EDM Snare 12	SD
4106	JL EDM Snare 13	SD

#	Drum Sample	DF
4107	JL EDM Snare 14	SD
4108	JL EDM Snare 15	SD
4109	JL EDM Snare 16	SD
4110	JL EDM Snare 17	SD
4111	JL EDM Snare 18	SD
4112	JL Moomba Kik 1	BD
4113	JL Moomba Kik 2	BD
4114	JL Moomba Kik 3	BD
4115	JL Moomba Kik 4	BD
4116	JL Moomba Kik 5	BD
4117	JL Moomba Kik 6	BD
4118	JL Moomba Kik 7	BD
4119	JL Moomba Kik 8	BD
4120	JL Moomba Kik 9	BD
4121	JL Moomba Kik 10	BD
4122	JL Moomba Kik 11	BD
4123	JL Moomba Kik 12	BD
4124	JL Moomba Kik 13	BD
4125	JL Moomba Kik 14	BD
4126	JL Moomba Kik 15	BD
4127	JL Moomba Kik 16	BD
4128	JL Moomba Kik 17	BD
4129	JL Moomba Kik 18	BD
4130	JL Moomba Kik 19	BD
4131	JL Moomba Kik 20	BD
4132	JL Moomba Kik 21	BD
4133	JL Moomba Kik 22	BD
4134	JL Moomba Kik 23	BD
4135	JL Moomba Kik 24	BD
4136	JL Moomba Kik 25	BD
4137	JL Moomba Kik 26	BD
4138	JL Moomba Kik 27	BD
4139	JL Moomba Kik 28	BD
4140	JL Moomba Kik 29	BD

#	Drum Sample	DF
4141	JL Moomba Kik 30	BD
4142	JL Moomba Kik 31	BD
4143	JL Moomba Kik 32	BD
4144	JL Moomba Kik 33	BD
4145	JL Moomba Kik 34	BD
4146	JL Moomba Snare 1	SD
4147	JL Moomba Snare 2	SD
4148	JL Moomba Snare 3	SD
4149	JL Moomba Snare 4	SD
4150	JL Moomba Snare 5	SD
4151	JL Moomba Snare 6	SD
4152	JL Moomba Snare 7	SD
4153	JL Moomba Snare 8	SD
4154	JL Moomba Snare 9	SD
4155	JL Moomba Snare 10	SD
4156	JL Moomba Snare 11	SD
4157	JL Moomba Snare 12	SD
4158	JL Moomba Snare 13	SD
4159	JL Moomba Snare 14	SD
4160	JL Moomba Snare 15	SD
4161	JL Moomba Snare 16	SD
4162	JL Moomba Snare 17	SD
4163	JL Moomba Snare 18	SD
4164	JL Moomba Snare 19	SD
4165	JL Moomba Snare 20	SD
4166	JL Moomba Snare 21	SD
4167	JL Moomba Snare 22	SD
4168	JL Moomba Snare 23	SD
4169	JL Moomba Snare 24	SD
4170	JL Moomba Snare 25	SD
4171	JL Moomba Snare 26	SD
4172	JL Moomba Snare 27	SD
4173	JL Moomba Snare 28	SD
4174	JL Moomba Snare 29	SD

#	Drum Sample	DF
4175	JL Moomba Snare 30	SD
4176	JL EDM Perc 1	LP
4177	JL EDM Perc 2	LP
4178	JL EDM Perc 3	LP
4179	JL EDM Perc 4	LP
4180	JL EDM Perc 5	LP
4181	JL EDM Perc 6	LP
4182	JL EDM Perc 7	LP
4183	JL EDM Perc 8	LP
4184	JL EDM Perc 9	LP
4185	JL EDM Perc 10	LP
4186	JL EDM Perc 11	LP
4187	JL EDM Perc 12	LP
4188	JL EDM Perc 13	LP
4189	JL EDM Perc 14	LP
4190	JL EDM Perc 15	LP
4191	JL EDM Perc 16	LP
4192	JL EDM Perc 17	LP
4193	JL EDM Perc 18	LP
4194	JL EDM Perc 19	LP
4195	JL EDM Perc 20	LP
4196	JL EDM Perc 21	LP
4197	JL EDM Perc 22	LP
4198	JL EDM Perc 23	LP
4199	JL EDM Perc 24	LP
4200	JL EDM Perc 25	LP
4201	JL EDM Perc 26	LP
4202	JL EDM Perc 27	LP
4203	JL EDM Perc 28	LP
4204	JL EDM Perc 29	LP
4205	JL EDM Perc 30	LP
4206	JL EDM Perc 31	LP
4207	JL EDM Perc 32	LP
4208	JL EDM Perc 33	LP

#	Drum Sample	DF
4209	JL EDM Perc 34	LP
4210	JL EDM Perc 35	LP
4211	JL EDM Perc 36	LP
4212	JL EDM Perc 37	LP
4213	JL EDM Perc 38	LP
4214	JL EDM Perc 39	LP
4215	JL EDM Perc 40	LP
4216	JL EDM Perc 41	LP
4217	JL EDM Perc 42	LP
4218	JL EDM Perc 43	LP
4219	JL EDM Perc 44	LP
4220	JL EDM Perc 45	LP
4221	JL EDM Perc 46	LP
4222	JL EDM Perc 47	LP
4223	JL EDM Perc 48	LP
4224	JL EDM Perc 49	LP
4225	JL EDM Perc 50	LP
4226	JL EDM Perc 51	LP
4227	JL EDM Perc 52	LP
4228	JL EDM Perc 53	LP
4229	JL EDM Perc 54	LP
4230	JL EDM Perc 55	LP
4231	JL EDM Perc 56	LP
4232	JL EDM Perc 57	LP
4233	JL EDM Perc 58	LP
4234	JL EDM Perc 59	LP
4235	JL EDM Perc 60	LP
4236	JL EDM Perc 61	LP
4237	JL EDM Perc 62	LP
4238	JL EDM Perc 63	LP
4239	JL EDM Perc 64	LP
4240	JL EDM Perc 65	LP
4241	JL EDM Perc 66	LP
4242	JL EDM Perc 67	LP

#	Drum Sample	DF
4243	JL EDM Perc 68	LP
4244	JL EDM Perc 69	LP
4245	JL EDM Perc 70	LP
4246	JL EDM Perc 71	LP
4247	JL EDM Perc 72	LP
4248	BD DL 01	BD
4249	BD DL 02	BD
4250	BD DL 03	BD
4251	BD DL 04	BD
4252	BD DL 05	BD
4253	BD DL 06	BD
4254	BD DL 07	BD
4255	BD DL 08	BD
4256	BD DL 09	BD
4257	BD DL 10	BD
4258	BD DL 11	BD
4259	BD DL 12	BD
4260	BD DL 13	BD
4261	BD DL 14	BD
4262	BD DL 15	BD
4263	BD DL 16	BD
4264	BD DL 17	BD
4265	BD DL 18	BD
4266	BD DL 19	BD
4267	BD DL 20	BD
4268	BD DL 21	BD
4269	BD DL 22	BD
4270	BD DL 23	BD
4271	BD DL 24	BD
4272	BD DL 25	BD
4273	BD DL 26	BD
4274	BD DL 27	BD
4275	BD DL 28	BD
4276	BD DL 29	BD

#	Drum Sample	DF
4277	BD DL 30	BD
4278	BD DL 31	BD
4279	BD DL 32	BD
4280	BD DL 33	BD
4281	BD DL 34	BD
4282	BD DL 35	BD
4283	BD DL 36	BD
4284	BD DL 37	BD
4285	BD DL 38	BD
4286	BD DL 39	BD
4287	BD DL 40	BD
4288	BD DL 41	BD
4289	BD DL 42	BD
4290	BD DL 43	BD
4291	BD DL 44	BD
4292	BD DL 45	BD
4293	BD DL 46	BD
4294	BD DL 47	BD
4295	BD DL 48	BD
4296	BD DL 49	BD
4297	BD DL 50	BD
4298	BD DL 51	BD
4299	BD DL 52	BD
4300	BD DL 53	BD
4301	BD DL 54	BD
4302	BD DL 55	BD
4303	BD DL 56	BD
4304	BD DL 57	BD
4305	BD DL 58	BD
4306	BD DL 59	BD
4307	BD DL 60	BD
4308	BD DL 61	BD
4309	BD DL 62	BD
4310	BD DL 63	BD

#	Drum Sample	DF
4311	BD DL 64	BD
4312	BD DL 65	BD
4313	BD DL 66	BD
4314	BD DL 67	BD
4315	BD DL 68	BD
4316	BD DL 69	BD
4317	BD DL 70	BD
4318	BD DL 71	BD
4319	BD RM A	BD
4320	BD RM B	BD
4321	BD RM C	BD
4322	BD RM D	BD
4323	BD RM E	BD
4324	BD RM F	BD
4325	BD RM G	BD
4326	BD RM H	BD
4327	SD DL 01	SD
4328	SD DL 02	SD
4329	SD DL 03	SD
4330	SD DL 04	SD
4331	SD DL 05	SD
4332	SD DL 06	SD
4333	SD DL 07	SD
4334	SD DL 08	SD
4335	SD DL 09	SD
4336	SD DL 10	SD
4337	SD DL 11	SD
4338	SD DL 12	SD
4339	SD DL 13	SD
4340	SD DL 14	SD
4341	SD DL 15	SD
4342	SD DL 16	SD
4343	SD DL 17	SD
4344	SD DL 18	SD

#	Drum Sample	DF
4345	SD DL 19	SD
4346	SD DL 20	SD
4347	SD DL 21	SD
4348	SD DL 22	SD
4349	SD DL 23	SD
4350	SD DL 24	SD
4351	SD DL 25	SD
4352	SD DL 26	SD
4353	SD DL 27	SD
4354	SD DL 28	SD
4355	SD DL 29	SD
4356	SD DL 30	SD
4357	SD DL 31	SD
4358	SD DL 32	SD
4359	SD DL 33	SD
4360	SD DL 34	SD
4361	SD DL 35	SD
4362	SD DL 36	SD
4363	SD DL 37	SD
4364	SD DL 38	SD
4365	SD DL 39	SD
4366	SD DL 40	SD
4367	SD DL 41	SD
4368	SD DL 42	SD
4369	SD DL 43	SD
4370	SD DL 44	SD
4371	SD DL 45	SD
4372	SD DL 46	SD
4373	SD DL 47	SD
4374	SD DL 48	SD
4375	SD DL 49	SD
4376	SD DL 50	SD
4377	SD DL 51	SD
4378	SD DL 52	SD

#	Drum Sample	DF
4379	SD DL 53	SD
4380	SD DL 54	SD
4381	SD DL 55	SD
4382	SD DL 56	SD
4383	SD DL 57	SD
4384	SD DL 58	SD
4385	SD DL 59	SD
4386	SD DL 60	SD
4387	SD DL 61	SD
4388	SD DL 62	SD
4389	SD DL 63	SD
4390	SD DL 64	SD
4391	SD DL 65	SD
4392	SD DL 66	SD
4393	SD DL 67	SD
4394	SD DL 68	SD
4395	SD DL 69	SD
4396	SD DL 70	SD
4397	SD DL 71	SD
4398	SD DL 72	SD
4399	SD DL 73	SD
4400	SD DL 74	SD
4401	SD DL 75	SD
4402	SD DL 76	SD
4403	SD DL 77	SD
4404	SD DL 78	SD
4405	SD DL 79	SD
4406	SD DL 80	SD
4407	SD DL 81	SD
4408	SD DL 82	SD
4409	SD DL 83	SD
4410	SD DL 84	SD
4411	SD DL 85	SD
4412	SD DL 86	SD

#	Drum Sample	DF
4413	SD DL 87	SD
4414	SD DL 88	SD
4415	SD DL 89	SD
4416	SD DL 90	SD
4417	SD DL 91	SD
4418	SD DL 92	SD
4419	SD DL 93	SD
4420	SD DL 94	SD
4421	SD DL 95	SD
4422	SD DL 96	SD
4423	SD DL 97	SD
4424	SD DL 98	SD
4425	SD DL 99	SD
4426	SD DL 100	SD
4427	SD DL 101	SD
4428	SD DL 102	SD
4429	SD DL 103	SD
4430	SD DL 104	SD
4431	SD DL 105	SD
4432	SD DL 106	SD
4433	SD DL 107	SD
4434	SD DL 108	SD
4435	SD DL 109	SD
4436	SD DL 110	SD
4437	SD DL 111	SD
4438	SD DL 112	SD
4439	SD DL 113	SD
4440	SD DL 114	SD
4441	SD DL 115	SD
4442	SD DL 116	SD
4443	SD DL 117	SD
4444	SD DL 118	SD
4445	SD DL 119	SD
4446	SD DL 120	SD

#	Drum Sample	DF
4447	HH DL 1	HH
4448	HH DL 2	HH
4449	HH DL 3	HH
4450	HH DL 4	HH
4451	HH DL 5	HH
4452	HH DL 6	HH
4453	HH DL 7	HH
4454	HH DL 8	HH
4455	HH DL 9	HH
4456	HH DL 10	HH
4457	HH DL 11	HH
4458	HH DL 12	HH
4459	HH DL 13	HH
4460	HH DL 14	HH
4461	HH DL 15	HH
4462	HH DL 16	HH
4463	HH DL 17	HH
4464	HH DL 18	HH
4465	HH DL 19	HH
4466	HH DL 20	HH
4467	HH DL 21	HH
4468	HH DL 22	HH
4469	HH DL 23	HH
4470	HH DL 24	HH
4471	HH DL 25	HH
4472	HH DL 26	HH
4473	HH DL 27	HH
4474	HH DL 28	HH
4475	HH DL 29	HH
4476	CRASH DL HOP	-
4477	Perc DL 01	LP
4478	Perc DL 02	LP
4479	Perc DL 03	LP
4480	Perc DL 04	LP

#	Drum Sample	DF
4481	Perc DL 05	LP
4482	Perc DL 06	LP
4483	Perc DL 07	LP
4484	Perc DL 08	LP
4485	Perc DL 09	LP
4486	Perc DL 10	LP
4487	Perc DL 11	LP
4488	Perc DL 12	LP
4489	Perc DL 13	LP
4490	Perc DL 14	LP
4491	Perc DL 15	LP
4492	Perc DL 16	LP
4493	Perc DL 17	LP
4494	Perc DL 18	LP
4495	Perc DL 19	LP
4496	Perc DL 20	LP
4497	Perc DL 21	LP
4498	Perc DL 22	LP
4499	Perc DL 23	LP
4500	Perc DL 24	LP
4501	Perc DL 25	LP
4502	Perc DL 26	LP
4503	Perc DL 27	LP
4504	Perc DL 28	LP
4505	Perc DL 29	LP
4506	Perc DL 30	LP
4507	Perc DL 31	LP
4508	Perc DL 32	LP
4509	Perc DL 33	LP
4510	Perc DL 34	LP
4511	Perc DL 35	LP
4512	Perc DL 36	LP
4513	Perc DL 37	LP
4514	Perc DL 38	LP

#	Drum Sample	DF
4515	Perc DL 39	LP
4516	Perc DL 40	LP
4517	Perc DL 41	LP
4518	Perc DL 42	LP
4519	Perc DL 43	LP
4520	Perc DL 44	LP
4521	Perc DL 45	LP
4522	Perc DL 46	LP
4523	Perc DL 47	LP
4524	Perc DL 48	LP
4525	Perc DL 49	LP
4526	Perc DL 50	LP
4527	Perc DL 51	LP
4528	Perc DL 52	LP
4529	Perc DL 53	LP
4530	Perc DL 54	LP
4531	Perc DL 55	LP
4532	Perc DL 56	LP
4533	Perc DL 57	LP
4534	Perc DL 58	LP
4535	Perc DL 59	LP
4536	Perc DL 60	LP
4537	Perc DL 61	LP
4538	Perc DL 62	LP
4539	Perc DL 63	LP
4540	Perc DL 64	LP
4541	Perc DL 65	LP
4542	Perc DL 66	LP
4543	Perc DL 67	LP
4544	Perc DL 68	LP
4545	Perc DL 69	LP
4546	Perc DL 70	LP
4547	Perc DL 71	LP
4548	Perc DL 72	LP

#	Drum Sample	DF
4549	Perc DL 73	LP
4550	Perc DL 74	LP
4551	Perc DL 01	HP
4552	Perc DL 02	HP
4553	Perc DL 03	HP
4554	Perc DL 04	HP
4555	Perc DL 05	HP
4556	Perc DL 06	HP
4557	Perc DL 07	HP
4558	Perc DL 08	HP
4559	Perc DL 09	HP
4560	Perc DL 10	HP
4561	Perc DL 11	HP
4562	Perc DL 12	HP
4563	Perc DL 13	HP
4564	Perc DL 14	HP
4565	Perc DL 15	HP
4566	Perc DL 16	HP
4567	Perc DL 17	HP
4568	Perc DL 18	HP
4569	Perc DL 19	HP
4570	SFX DL 01	SFX
4571	SFX DL 02	SFX
4572	SFX DL 03	SFX
4573	SFX DL 04	SFX
4574	SFX DL 05	SFX
4575	SFX DL 06	SFX
4576	SFX DL 07	SFX
4577	SFX DL 08	SFX
4578	SFX DL 09	SFX
4579	SFX DL 10	SFX
4580	SFX DL 11	SFX
4581	SFX DL 12	SFX
4582	SFX DL 13	SFX

#	Drum Sample	DF
4583	SFX DL 14	SFX
4584	SFX DL 15	SFX
4585	SFX DL 16	SFX
4586	SFX DL 17	SFX
4587	SFX DL 18	SFX
4588	SFX DL 19	SFX
4589	SFX DL 20	SFX
4590	SFX DL 21	SFX
4591	SFX DL 22	SFX
4592	SFX DL 23	SFX
4593	SFX DL 24	SFX
4594	SFX DL 25	SFX
4595	SFX DL 26	SFX
4596	SFX DL 27	SFX
4597	SFX DL 28	SFX
4598	SFX DL 29	SFX
4599	SFX DL 30	SFX
4600	SFX DL 31	SFX
4601	SFX DL 32	SFX
4602	SFX DL 33	SFX
4603	SFX DL 34	SFX
4604	SFX DL 35	SFX
4605	SFX DL 36	SFX
4606	SFX DL 37	SFX
4607	SFX DL 38	SFX
4608	SFX DL 39	SFX
4609	SFX DL 40	SFX
4610	SFX DL 41	SFX
4611	SFX DL 42	SFX
4612	SFX DL 43	SFX
4613	SFX DL 44	SFX
4614	SFX DL 45	SFX
4615	SFX DL 46	SFX
4616	SFX DL 47	SFX

#	Drum Sample	DF
4617	SFX DL 48	SFX
4618	SFX DL 49	SFX
4619	SFX DL 50	SFX
4620	SFX DL 51	SFX
4621	SFX DL 52	SFX
4622	SFX DL 53	SFX
4623	SFX DL 54	SFX
4624	SFX DL 55	SFX
4625	SFX DL 56	SFX
4626	SFX DL 57	SFX
4627	SFX DL 58	SFX
4628	SFX DL 59	SFX
4629	SFX DL 60	SFX
4630	SFX DL 61	SFX
4631	SFX DL 62	SFX
4632	SFX DL 63	SFX
4633	SFX DL 64	SFX
4634	SFX DL 65	SFX
4635	SFX DL 66	SFX
4636	SFX DL 67	SFX
4637	SFX DL 68	SFX
4638	SFX DL 69	SFX
4639	SFX DL 70	SFX
4640	SFX DL 71	SFX
4641	SFX DL 72	SFX
4642	SFX DL 73	SFX
4643	SFX DL 74	SFX
4644	SFX DL 75	SFX
4645	SFX DL 76	SFX
4646	SFX DL 77	SFX
4647	SFX DL 78	SFX
4648	SFX DL 79	SFX
4649	SFX DL 80	SFX
4650	SFX DL 81	SFX

#	Drum Sample	DF
4651	SFX DL 82	SFX
4652	SFX DL 83	SFX
4653	SFX DL 84	SFX
4654	SFX DL 85	SFX
4655	SFX DL 86	SFX
4656	SFX DL 87	SFX
4657	SFX DL 88	SFX
4658	SFX DL 89	SFX
4659	SFX DL 90	SFX
4660	SFX DL 91	SFX
4661	SFX DL 92	SFX
4662	SFX DL 93	SFX
4663	SFX DL 94	SFX
4664	SFX DL 95	SFX
4665	SFX DL 96	SFX
4666	SFX DL 97	SFX
4667	SFX DL 98	SFX
4668	SFX DL 99	SFX
4669	SFX DL 100	SFX
4670	SFX DL 101	SFX
4671	SFX DL 102	SFX
4672	SFX DL 103	SFX
4673	SFX DL 104	SFX
4674	SFX DL 105	SFX
4675	SFX DL 106	SFX
4676	SFX DL 107	SFX
4677	SFX DL 108	SFX
4678	SFX DL 109	SFX
4679	SFX DL 110	SFX
4680	SFX DL 111	SFX
4681	SFX DL 112	SFX
4682	SFX DL 113	SFX
4683	SFX DL 114	SFX
4684	SFX DL 115	SFX

#	Drum Sample	DF
4685	SFX DL 116	SFX
4686	SFX DL 117	SFX
4687	SFX DL 118	SFX
4688	SFX DL 119	SFX
4689	SFX DL 120	SFX
4690	SFX DL 121	SFX
4691	SFX DL 122	SFX
4692	SFX DL 123	SFX
4693	SFX DL 124	SFX
4694	SFX DL 125	SFX
4695	SFX DL 126	SFX
4696	SFX DL 127	SFX
4697	SFX DL 128	SFX
4698	SFX DL 129	SFX
4699	SFX DL 130	SFX
4700	SFX DL 131	SFX
4701	SFX DL 132	SFX
4702	SFX DL 133	SFX
4703	SFX DL 134	SFX
4704	SFX DL 135	SFX
4705	SFX DL 136	SFX
4706	SFX DL 137	SFX
4707	SFX DL 138	SFX
4708	SFX DL 139	SFX
4709	SFX DL 140	SFX
4710	SFX DL 141	SFX
4711	SFX DL 142	SFX
4712	SFX DL 143	SFX
4713	SFX DL 144	SFX
4714	SFX DL 145	SFX
4715	SFX DL 146	SFX
4716	SFX DL 147	SFX
4717	SFX DL 148	SFX
4718	SFX DL 149	SFX

#	Drum Sample	DF
4719	SFX DL 150	SFX
4720	SFX DL 151	SFX
4721	SFX DL 152	SFX
4722	SFX DL 153	SFX
4723	SFX DL 154	SFX
4724	SFX DL 155	SFX
4725	SFX DL 156	SFX
4726	SFX DL 157	SFX
4727	SFX DL 158	SFX
4728	SFX DL 159	SFX
4729	SFX DL 160	SFX
4730	SFX DL 161	SFX
4731	SFX DL 162	SFX
4732	SFX DL 163	SFX
4733	SFX DL 164	SFX
4734	SFX DL 165	SFX
4735	SFX DL 166	SFX
4736	SFX DL 167	SFX
4737	SFX DL 168	SFX
4738	SFX DL 169	SFX
4739	SFX DL 170	SFX
4740	SFX DL 171	SFX
4741	SFX DL 172	SFX
4742	SFX DL 173	SFX
4743	SFX DL 174	SFX
4744	SFX DL 175	SFX
4745	SFX DL 176	SFX
4746	SFX DL 177	SFX
4747	SFX DL 178	SFX
4748	SFX DL 179	SFX
4749	SFX DL 180	SFX
4750	SFX DL 181	SFX
4751	SFX DL 182	SFX
4752	SFX DL 183	SFX

#	Drum Sample	DF
4753	SFX DL 184	SFX
4754	SFX DL 185	SFX
4755	SFX DL 186	SFX
4756	SFX DL 187	SFX
4757	SFX DL 188	SFX
4758	SFX DL 189	SFX
4759	SFX DL 190	SFX
4760	Cinematic Impact 1	SFX
4761	Cinematic Impact 2	SFX
4762	Cinematic Impact 3	SFX
4763	Cinematic Impact 4	SFX
4764	Cinematic Impact 5	SFX
4765	Cinematic Impact 6	SFX
4766	Cinematic Impact 7	SFX
4767	Cinematic Bang 1	SFX
4768	Cinematic Bang 2	SFX
4769	Cinematic Bang 3	SFX
4770	Cinematic Bang 4	SFX
4771	Cinematic Bang 5	SFX
4772	Cinematic Bang 6	SFX
4773	Cinematic Bang 7	SFX
4774	Cinematic Bang 8	SFX
4775	Cinematic Bang 9	SFX
4776	Cinematic Bang 10	SFX
4777	Cinematic Bang 11	SFX
4778	Cinematic Rev Atk1	SFX
4779	Cinematic Rev Atk2	SFX
4780	Cinematic Rev Atk3	SFX
4781	Reverse Attack 1	SFX
4782	Reverse Attack 2	SFX
4783	Reverse Attack 3	SFX
4784	Reverse Attack 4	SFX
4785	Reverse Attack 5	SFX
4786	Reverse Attack 6	SFX

#	Drum Sample	DF
4787	Evolutionary Rev	SFX
4788	Evolving Back	SFX
4789	Bang Metal 1	SFX
4790	Bang Metal 2	SFX
4791	Bang Metal 3	SFX
4792	Bang Metal 4	SFX
4793	Bang Metal 5	SFX
4794	Bang Metal 6	SFX
4795	Bang Metal 7	SFX
4796	Bang Metal 8	SFX
4797	Bang Metal 9	SFX
4798	Bang Metal 10	SFX
4799	Bang Metal 11	SFX
4800	Bang Metal 12	SFX
4801	Bang Metal 13	SFX
4802	Bang Metal 14	SFX
4803	Bang Metal 15	SFX
4804	Bang Metal 16	SFX
4805	Bang Metal 17	SFX
4806	Bang Metal 18	SFX
4807	Bang Metal 19	SFX
4808	Bang Metal 20	SFX
4809	Bang Metal 21	SFX
4810	Bang Metal 22	SFX
4811	Bang Metal 23	SFX
4812	Bang Metal 24	SFX
4813	Bang Metal 25	SFX
4814	Bang Metal 26	SFX
4815	Bang Metal 27	SFX
4816	Bang Metal 28	SFX
4817	Bang Metal 29	SFX
4818	Bang Metal 30	SFX
4819	Bang Metal 31	SFX
4820	Bang Metal 32	SFX

#	Drum Sample	DF
4821	Bang Metal 33	SFX
4822	Bang Metal 34	SFX
4823	Bang Metal 35	SFX
4824	Bang Punch 1	SFX
4825	Bang Punch 2	SFX
4826	Bang Punch 3	SFX
4827	Bang Punch 4	SFX
4828	Bang Punch 5	SFX
4829	Bang Punch 6	SFX
4830	Bang Punch 7	SFX
4831	Bang Punch 8	SFX
4832	Bang Punch 9	SFX
4833	Bang Punch 10	SFX
4834	Bang Punch 11	SFX
4835	Bang Punch 12	SFX
4836	Bang Punch 13	SFX
4837	Bang Punch 14	SFX
4838	Bang Punch 15	SFX
4839	Bang Punch 16	SFX
4840	Bang Punch 17	SFX
4841	Bang Punch 18	SFX
4842	Bang Punch 19	SFX
4843	Bang Punch 20	SFX
4844	Bang Punch 21	SFX
4845	Bang Punch 22	SFX
4846	Bang Punch 23	SFX
4847	Bang Punch 24	SFX
4848	Bang Punch 25	SFX
4849	Bang Punch 26	SFX
4850	Bang Punch 27	SFX
4851	Bang Punch 28	SFX
4852	Bang Punch 29	SFX
4853	Bang Punch 30	SFX
4854	Bang Punch 31	SFX

#	Drum Sample	DF
4855	Bang Punch 32	SFX
4856	Bang Punch 33	SFX
4857	Bang Punch 34	SFX
4858	Bang Punch 35	SFX
4859	Bang Punch 36	SFX
4860	Bang Punch 37	SFX
4861	Bang Punch 38	SFX
4862	Bang Punch 39	SFX
4863	Bang Punch 40	SFX
4864	Bang Punch 41	SFX
4865	Bang Punch 42	SFX
4866	Bang Punch 43	SFX
4867	Break Attack 1	SFX
4868	Break Attack 2	SFX
4869	Break Attack 3	SFX
4870	Break Attack 4	SFX
4871	Break Attack 5	SFX
4872	Break Attack 6	SFX
4873	Break Attack 7	SFX
4874	Break Attack 8	SFX
4875	Break Attack 9	SFX
4876	Break Attack 10	SFX
4877	Break Attack 11	SFX
4878	Break Attack 12	SFX
4879	Break Attack 13	SFX
4880	Break Attack 14	SFX
4881	Break Attack 15	SFX
4882	Break Attack 16	SFX
4883	Break Attack 17	SFX
4884	Break Attack 18	SFX
4885	Break Attack 19	SFX
4886	Break Attack 20	SFX
4887	Break Attack 21	SFX
4888	Break Attack 22	SFX

#	Drum Sample	DF
4889	Break Attack 23	SFX
4890	Break Attack 24	SFX
4891	Break Attack 25	SFX
4892	Break Attack 26	SFX
4893	Break Attack 27	SFX
4894	Break Attack 28	SFX
4895	Bang Industry 1	SFX
4896	Bang Industry 2	SFX
4897	Bang Industry 3	SFX
4898	Bang Industry 4	SFX
4899	Bang Industry 5	SFX
4900	Bang Industry 6	SFX
4901	Bang Industry 7	SFX
4902	Bang Industry 8	SFX
4903	Bang Industry 9	SFX
4904	Bang Industry 10	SFX
4905	Bang Industry 11	SFX
4906	Bang Industry 12	SFX
4907	Bang Industry 13	SFX
4908	Bang Industry 14	SFX
4909	Bang Industry 15	SFX
4910	Bang Industry 16	SFX
4911	Bang Industry 17	SFX
4912	Bang Industry 18	SFX
4913	Bang Industry 19	SFX
4914	Bang Industry 20	SFX
4915	Bang Industry 21	SFX
4916	Bang Industry 22	SFX
4917	Bang Industry 23	SFX
4918	Bang Industry 24	SFX
4919	Bang Industry 25	SFX
4920	Bang Industry 26	SFX
4921	Bang Industry 27	SFX
4922	Sci-fi Shifter 1	SFX

#	Drum Sample	DF
4923	Sci-fi Shifter 2	SFX
4924	Sci-fi Shifter 3	SFX
4925	Sci-fi Shifter 4	SFX
4926	Sci-fi Shifter 5	SFX
4927	Sci-fi Shifter 6	SFX
4928	Sci-fi Shifter 7	SFX
4929	Sci-fi Shifter 8	SFX
4930	Sci-fi Shifter 9	SFX
4931	Uplifting Shift	SFX
4932	Downer Shift	SFX
4933	Atoms SEQ 1 (BPM120)	SFX
4934	Atoms SEQ 2 (BPM120)	SFX
4935	Atoms SEQ 3 (BPM120)	SFX
4936	Atoms SEQ 4 (BPM120)	SFX
4937	Atoms SEQ 5 (BPM120)	SFX
4938	Atoms SEQ 6 (BPM120)	SFX
4939	Atoms SEQ 7 (BPM120)	SFX
4940	Atoms Sci-fi 1	SFX
4941	Atoms Sci-fi 2	SFX
4942	Atoms Sci-fi 3	SFX
4943	Atoms Sci-fi 4	SFX
4944	Atoms Sci-fi 5	SFX
4945	Atoms Sci-fi 6	SFX
4946	Atoms Sci-fi 7	SFX
4947	Atoms Sci-fi 8	SFX
4948	Atoms Cosmic	SFX
4949	Atoms Steamer	SFX
4950	Atoms Appearance	SFX
4951	Atoms Impact	SFX
4952	Noise Impact 1	SFX
4953	Noise Impact 2	SFX
4954	Noise Impact 3	SFX
4955	Lock Impact 1	SFX
4956	Lock Impact 2	SFX

#	Drum Sample	DF
4957	Lock Impact 3	SFX
4958	Dirty Impact	SFX
4959	Sub Break	SFX
4960	Lavabeat	SFX
4961	Bronze Hit	SFX
4962	Funny Bowl	SFX
4963	Metal Punch	SFX
4964	Drum Metal	SFX
4965	Sub Bang	SFX
4966	Sub Sweep	SFX
4967	Break Down	SFX
4968	Warp Synth 1	SFX
4969	Warp Synth 2	SFX
4970	Warp Synth 3	SFX
4971	Warp Synth 4	SFX
4972	Warp Synth 5	SFX
4973	Warp MS20 1	SFX
4974	Warp MS20 2	SFX
4975	Warp MS20 3	SFX
4976	Warp Atoms	SFX
4977	Warp Atmos	SFX
4978	Warp Landing	SFX
4979	Machine Screamer	SFX
4980	Machine Stop	SFX
4981	Digital Water	SFX
4982	Down Sub 1	SFX
4983	Down Sub 2	SFX
4984	Down Sub 3	SFX
4985	Atmos Melody 01	SFX
4986	Atmos Melody 02	SFX
4987	Atmos Melody 03	SFX
4988	Atmos Melody 04	SFX
4989	Atmos Melody 05	SFX
4990	Atmos Melody 06	SFX

#	Drum Sample	DF
4991	Atmos Melody 07	SFX
4992	Atmos Melody 08	SFX
4993	Atmos Melody 09	SFX
4994	Atmos Melody 10	SFX
4995	Atmos Melody 11	SFX
4996	Atmos Melody 12	SFX
4997	Atmos Melody 13	SFX
4998	Atmos Melody 14	SFX
4999	Atmos Melody 15	SFX
5000	Atmos Melody 16	SFX
5001	Atmos Melody 17	SFX
5002	Atmos Melody 18	SFX
5003	Atmos Fear	SFX
5004	Interlude 1	SFX
5005	Interlude 2	SFX
5006	Interlude 3	SFX
5007	Interlude 4	SFX
5008	Interlude 5	SFX
5009	Interlude 6	SFX
5010	Holding Grudges	SFX
5011	Stellar Slasher	SFX
5012	Flying Saucer	SFX
5013	Alien Organ	SFX
5014	Brain Core	SFX
5015	Dark Roll	SFX
5016	Lava Grungy	SFX
5017	Power Source	SFX
5018	Digi Boiling 1	SFX
5019	Digi Boiling 2	SFX
5020	Cave Wind	SFX
5021	Lose Contact	SFX
5022	Disruptive	SFX
5023	Bomber	SFX
5024	Invader Talk	SFX

#	Drum Sample	DF
5025	Emergency	SFX
5026	Invader's Threats	SFX
5027	Appearance	SFX
5028	Flying Over	SFX
5029	Space Radar	SFX
5030	Starting	SFX
5031	Transition 1	SFX
5032	Transition 2	SFX
5033	Transition 3	SFX
5034	Harm Organ	SFX
5035	LFO Industry	SFX
5036	Ceramic DragDrag	SFX
5037	Running Metal	SFX
5038	Tesla Coil	SFX
5039	Rev Awakening	SFX
5040	FX Sauropoda	SFX
5041	FX Pterosaur	SFX
5042	FX Ceratopsia	SFX
5043	FX Eureptilia	SFX
5044	FX Stegosauria	SFX
5045	Swirl Whip	SFX
5046	Sword	SFX
5047	Predation	SFX
5048	Flanger Noise	SFX
5049	Short Noise	SFX
5050	Funny Surprise	SFX
5051	Funny Mixed Voice	SFX
5052	Funny Laugh	SFX
5053	TV Contest Long	SFX
5054	TV Contest Short	SFX
5055	Slow Down	SFX
5056	Suspense	SFX
5057	Sound Logo 1	SFX
5058	Sound Logo 2	SFX

#	Drum Sample	DF
5059	Sound Logo 3a	SFX
5060	Sound Logo 3b	SFX
5061	Sound Logo 4a	SFX
5062	Sound Logo 4b	SFX
5063	Sound Logo 5	SFX
5064	Sound Logo 6	SFX
5065	Sound Logo 7	SFX
5066	Sound Logo 8	SFX
5067	Sound Logo 9	SFX
5068	Sound Logo 10	SFX
5069	Sound Logo 11	SFX
5070	Sound Logo 12	SFX
5071	Sound Logo 13	SFX
5072	Sound Logo 14	SFX
5073	Sound Logo 15	SFX
5074	Orchestra PA Hit	SFX
5075	Quiz Show Hit 1	SFX
5076	Quiz Show Hit 2	SFX
5077	Quiz Show Hit 3	SFX
5078	Correct!	SFX
5079	Buzzer	SFX
5080	Flash 1	SFX
5081	Flash 2	SFX
5082	Flash 3	SFX
5083	TV Game 1	SFX
5084	TV Game 2	SFX
5085	TV Game 3	SFX
5086	TV Game 4	SFX
5087	TV Game 5	SFX
5088	Up-Up 1	SFX
5089	Up-Up 2	SFX
5090	Bonus Stage	SFX
5091	Stage Passed	SFX
5092	Jingle 1	SFX

#	Drum Sample	DF
5093	Jingle 2	SFX
5094	Jingle 3	SFX
5095	Jingle 4	SFX
5096	Cartoon Shot 1	SFX
5097	Cartoon Shot 2	SFX
5098	Cartoon Shot 3	SFX
5099	Cartoon Shot 4	SFX
5100	Chord Shot Pf	SFX
5101	Chord Shot Str	SFX
5102	Chord Shot Gtr	SFX
5103	Chord Shot Harp	SFX
5104	Chord Shot Mallet	SFX
5105	Chord Shot Organ	SFX
5106	Chord Shot Digi EP	SFX
5107	Chord Shot Synth 1	SFX
5108	Chord Shot Synth 2a	SFX
5109	Chord Shot Synth 2b	SFX
5110	Chord Shot Synth 2c	SFX
5111	Chord Shot Synth 2d	SFX
5112	Chord Shot Synth 3	SFX
5113	Harp Arp 1	SFX
5114	Harp Arp 2	SFX
5115	Marimba Up	SFX
5116	Marimba Down	SFX
5117	Sitar Arp	SFX
5118	Windchime	SFX
5119	2Steps SFX 1	SFX
5120	2Steps SFX 2	SFX
5121	2Steps SFX 3	SFX
5122	2Steps SFX 4	SFX
5123	2Steps SFX 5	SFX
5124	4Steps SFX 1	SFX
5125	4Steps SFX 2	SFX
5126	4Steps SFX 3	SFX

#	Drum Sample	DF
5127	4Steps SFX 4	SFX
5128	4Steps SFX 5	SFX
5129	4Steps SFX 6	SFX
5130	4Steps SFX 7	SFX
5131	4Steps SFX 8	SFX
5132	Delayed SFX 1	SFX
5133	Delayed SFX 2	SFX
5134	1Shot SFX 1	SFX
5135	1Shot SFX 2	SFX
5136	1Shot SFX 3	SFX
5137	1Shot SFX 4	SFX
5138	1Shot SFX 5	SFX
5139	1Shot SFX 6	SFX
5140	1Shot SFX 7	SFX
5141	1Shot SFX 8	SFX
5142	1Shot SFX 9	SFX
5143	1Shot SFX 10	SFX
5144	1Shot SFX 11	SFX
5145	1Shot SFX 12	SFX
5146	1Shot SFX 13	SFX
5147	1Shot SFX 14	SFX
5148	1Shot SFX 15	SFX
5149	1Shot SFX 16	SFX
5150	1Shot SFX 17	SFX
5151	1Shot SFX 18	SFX
5152	1Shot SFX 19	SFX
5153	1Shot SFX 20	SFX
5154	1Shot SFX 21	SFX
5155	1Shot SFX 22	SFX
5156	1Shot SFX 23	SFX
5157	1Shot SFX 24	SFX
5158	1Shot SFX 25	SFX
5159	1Shot SFX 26	SFX
5160	1Shot SFX 27	SFX

#	Drum Sample	DF
5161	1Shot SFX 28	SFX
5162	1Shot SFX 29	SFX
5163	1Shot SFX 30	SFX
5164	1Shot SFX 31	SFX
5165	1Shot SFX 32	SFX
5166	1Shot SFX 33	SFX
5167	1Shot SFX 34	SFX
5168	1Shot SFX 35	SFX
5169	1Shot SFX 36	SFX
5170	1Shot SFX 37	SFX
5171	1Shot SFX 38	SFX
5172	1Shot SFX 39	SFX
5173	1Shot SFX 40	SFX
5174	1Shot SFX 41	SFX
5175	1Shot SFX 42	SFX
5176	1Shot SFX 43	SFX
5177	1Shot SFX 44	SFX
5178	1Shot SFX 45	SFX
5179	1Shot SFX 46	SFX
5180	1Shot SFX 47	SFX
5181	Perc.SFX 1	SFX
5182	Perc.SFX 2	SFX
5183	Perc.SFX 3	SFX
5184	Perc.SFX 4	SFX
5185	Perc.SFX 5	SFX
5186	Perc.SFX 6	SFX
5187	Perc.SFX 7	SFX
5188	Perc.SFX 8	SFX
5189	Perc.SFX 9	SFX
5190	Perc.SFX 10	SFX
5191	Perc.SFX 11	SFX
5192	SFX Rain 1	SFX
5193	SFX Rain 2	SFX
5194	SFX Rain 3	SFX

#	Drum Sample	DF
5195	SFX Rain 4	SFX
5196	SFX Rain 5	SFX
5197	SFX Rain 6	SFX
5198	SFX Thunder 1	SFX
5199	SFX Thunder 2	SFX
5200	SFX Thunder 3	SFX
5201	SFX Thunder 4	SFX
5202	SFX Thunder 5	SFX
5203	SFX Thunder 6	SFX
5204	SFX Wind 1	SFX
5205	SFX Wind 2	SFX
5206	SFX Wind 3	SFX
5207	SFX Wind 4	SFX
5208	SFX Hail	SFX
5209	SFX Harbor	SFX
5210	SFX Sea 1	SFX
5211	SFX Sea 2	SFX
5212	SFX Sea 3	SFX
5213	SFX Sea 4	SFX
5214	SFX Sea 5	SFX
5215	SFX Sea 6	SFX
5216	SFX River 1	SFX
5217	SFX River 2	SFX
5218	SFX River 3	SFX
5219	SFX River 4	SFX
5220	SFX Bird 1	SFX
5221	SFX Bird 2	SFX
5222	SFX Bird 3	SFX
5223	SFX Bird 4	SFX
5224	SFX Bird 5	SFX
5225	SFX Bird 6	SFX
5226	SFX Bird 7	SFX
5227	SFX Bird 8	SFX
5228	SFX Bird 9	SFX

#	Drum Sample	DF
5229	SFX Frog 1	SFX
5230	SFX Frog 2	SFX
5231	SFX Frog 3	SFX
5232	SFX Frog 4	SFX
5233	SFX Frog 5	SFX
5234	SFX Cicada 1	SFX
5235	SFX Cicada 2	SFX
5236	SFX Cicada 3	SFX
5237	SFX Cicada 4	SFX
5238	SFX Insect 1	SFX
5239	SFX Insect 2	SFX
5240	SFX Insect 3	SFX
5241	SFX Insect 4	SFX
5242	SFX Insect 5	SFX
5243	SFX Cricket 1	SFX
5244	SFX Cricket 2	SFX
5245	SFX Traffic 1	SFX
5246	SFX Traffic 2	SFX
5247	SFX Traffic 3	SFX
5248	SFX Traffic 4	SFX
5249	SFX Fireworks 1	SFX
5250	SFX Fireworks 2	SFX
5251	SFX Fireworks 3	SFX
5252	SFX Fireworks 4	SFX
5253	SFX Fireworks 5	SFX
5254	SFX Fireworks 6	SFX
5255	SFX Fireworks 7	SFX
5256	SFX Bonfire	SFX
5257	SFX Park 1	SFX
5258	SFX Park 2	SFX
5259	SFX Park 3	SFX
5260	SFX Park 4	SFX
5261	SFX Clock	SFX
5262	SFX Stopwatch	SFX

#	Drum Sample	DF
5263	SFX Clock Struck 1	SFX
5264	SFX Clock Struck 2	SFX
5265	SFX Train 1	SFX
5266	SFX Train 2	SFX
5267	SFX Busy Road	SFX
5268	SFX Emerging 1	SFX
5269	SFX Emerging 2	SFX
5270	SFX Emerging 3	SFX
5271	SFX Stone Grind 1	SFX
5272	SFX-Stone Grind 2	SFX
5273	SFX-Water Stone 1	SFX
5274	SFX-Water Stone 2	SFX
5275	SFX-Water Stone 3	SFX
5276	SFX-Water Stone 4	SFX
5277	SFX-Heartbeat 1	SFX
5278	SFX-Heartbeat 2	SFX
5279	Alarm	SFX
5280	MetalSheet-Hit 1	SFX
5281	MetalSheet-Hit 2	SFX
5282	MetalSheet-Hit 3	SFX
5283	MetalSheet-Hit 4	SFX
5284	Clap-Hard Dance 1	SFX
5285	Click 1 Sample	SFX
5286	Click 3 Samples	SFX
5287	Click 7 Samples	SFX

Legend:

BD = Bass Drum

SD = Snare Drum

TM = Tom

HH = Hi Hat

CY = CYmbal

LP = Low Percussion

HP = Hi Percussion

SFX = Special FX

Styles

This list shows the Factory Styles as they appear in the **Style Select** window.

Pop

Blinding Pop
Underdog Pop
Snowman Pop
Reggae Pop
Funk Pop
Simply Groove
Guitar Pop
Hot Summer Pop
16 Beat Groove
In the Air Pop
Shape Pop
16 Beat Pop
Blueberry Shuffle
Sunrise Pop Funk
Everything Pop
Future Pop
10000 Hours Pop
New Analog Pop
Love Pop
Standard 8 Beat
Groovy Pop
Slow Pop
Morning Pop
Happy Pop
Pop Hit
Pop Beat
Easy Pop Shuffle
Classic Beat
Classic Pop
Pop Rock
Vintage Pop 1
Vintage Pop 2
Retro Beat
12/8 Pop

Slow Latin Pop
Drum'n Boogaloo
Guitar Beat
Soft 16 Beat
Corazon Pop
24000 Magic Pop
Boyband Pop
Pop '21
New 50's Pop
Weekend Pop
Fast Guitar Pop
Can't Stop Pop
New Synth Pop
Believer Pop
How Long Pop
Spanish Pop
Santa's Pop
8 Beat Pop
Side Pop
Valentine Pop
Basic 8 Beat
Careless Pop
Fisa Pop
Feel Me Pop
Head First Pop

Classic Pop

Jude Pop
Rosanna Pop
Roxanne Pop
Lovely Day Pop
Curiosity Pop
Say Pop
Georgy Pop
B. Jean Pop

70's Guitar Pop
Sunny Pop
A Believer Pop
Cool Pop
Shadow Pop
Pop Shuffle 1
Pop Shuffle 2
Copacabana Pop
As Groove
Gigolo' Shuffle
Love Inside Pop
Venus Pop
Wake Me Pop
Crazy Little Pop
Croco Rock
Lovely Pop
Soul Family Pop
Meneater Pop
Earth Beat

Ballad

Twilight Ballad
Blue Eye Ballad
Break Pop Ballad
6/8 Wonderful Ballad
Home Ballad
Serenade Ballad
Something Ballad
Next Ballad
Passenger Ballad
6/8 Ballad
Modern Ballad
Slow Guitar Ballad
Soft Ballad

Piano Ballad
Organ Ballad
Orchestral Ballad
Unplugged
70's Ballad
Funky Ballad
Jazz Ballad
Groovy Ballad 1
Groovy Ballad 2
Analog Ballad 1
Analog Ballad 2
6/8 Brush Ballad
6/8 Slow
6/8 Slow Ballad
6/8 Piano Ballad
12/8 Ballad
6/4 Ballad
Unplugged Heaven
Unplugged Ballad 1
Unplugged Ballad 2
Unplugged Guitar 1
Unplugged Guitar 2
Ambient Ballad
Bossa Ballad
3/4 Jazz Ballad
Long Life Ballad
Believe Ballad
Color Ballad
Analog Groove
Hopless Ballad
Years Ballad
Atmosphere Ballad
Belong Ballad
16 Beat Ballad
Birds Ballad

Indie Ballad	Funky Disco 2	Foxtrot	Wing Slow Rock
Guitar Ballad	Tribal	Boogie Woogie	Foo Rock
Slow Down Ballad	Euro Trance	Big Band Jump	21 Gun Anthem
Arkansas Ballad	Synth Beat	Big Band Fox	First Kid Rock
Rock Ballad	Dance To Trance	Big Band Swing	Killer Rock
Good Ballad	NU Disco	Organ Waltz	Highway Hell Rock
Funk Ballad	Trap Dance 1	Charleston	Rock on Fire
Goodbye Ballad	Trap Dance 2	Twist	Welcome Rock
	Deep House	Hully Gully	Rock Star
Dance	Trance	Italian Polka 1	Jump Rock
All Night Dance	Saturday Disco	Italian Polka 2	Tiger Rock
What Is Dance	Slowly Dance	Italian Mazurka 1	Rock Shuffle 1
Nobody Dance	Falling Dance	Italian Mazurka 2	Rock Shuffle 2
Earth Dance	Cloud Disco	Italian Waltz	Rolling Blues
I Like 80's	Elektro Dance 1	Italian Tango	Alabama Rock
Wait Dance	Elektro Dance 2	Italian Fox	Clean Rock
70's Disco Remix	Elektro Dance 3	Organ Foxtrot	Stadium Ballad
'70 Remix	Kiss Dance	Heimat Walzer	Rolling Rock
70's Disco	Angel Dance	Bavarian Polka 1	Magic Rock
80's Dance	Seq Dance	Bavarian Polka 2	Prison Rock
90's Dance	Good Time Dance	German Polka 1	Johnny Rock
No Worry Dance	Guitar Dance	German Polka 2	Rock the Clock
Dj Disco Mix	Sometimes Dance	German Waltz 1	Rockabilly
Spanish Remix	Don't Start Dance	German Waltz 2	Best Rock
Cha Cha Remix	I Feel Dance	German Shuffle	Smoke Rock
Western Remix	Showbiz Dance	6/8 German Ballad	69's Rock
Kuduro Dance		Musette Waltz	Walk of Rock
Gangnam Dance	Ballroom	French Waltz	50's Rock & Roll
Bailando Dance	English Waltz	Irish Slow Waltz	60's Rock & Roll
Get Luck Disco	Quickstep	Irish Medium Waltz	Rock Oldie
Release Dance	Pasodoble	Irish Fast Waltz	Surf Rock
Fast Remix	Paso Dance	Jive	6/8 Slow Rock
Dance Revival	Argentina Tango	Irish Quickstep	6/8 Rock
Garage	Modern Tango		60's Slow Rock
Electro House	Slow Waltz 1	Rock	Abbey Rock
Ethno House	Slow Waltz 2	Liquid Rock	Rock Cha Cha
Drum & Bass	3/4 Flamenco	Uptempo Rock	Slow Latin Rock
Dance Fever	Flamenco	Straight Rock	Latin Rock
Sister & Girl	Wien Waltz	Piano Rock	South Strait Rock
Philly Disco	Swing Fox	Rock Songwriter	Rock Boogie
Love Disco	Slow Fox	Flying Rock	Rock Blues
Funky Disco 1	Fox Shuffle	6/8 Rock Ballad	Power Rock

8 Beat Rock	Country Pop	Salsa 1	Calypso
Rock Beat	Soft Guitar Country	Salsa 2	Latin Club
Final Rock	Country Fox	Pop Cha Cha	Guitar Latin
Unplugged Rock	Country Blues	Latin Bolero	Lambada
Sweet Rock		Sabor	Meneaito
Ring Slow Boogie	Latin	Merengue	Macarena
One Rock Ballad	Sway Cha Cha	Bachata	Bayon
Best Fake Rock	Chillout Bossa	Latin Lounge	Unplugged Gipsy
Tongue Rock	Sweet Bossa	Latin Pop	Unplugged Reggae
	Wonderful Bossa	Smooth Latin Jazz	Sambalegre
Country	Slow Latin Ballad	Unplugged Latin	Samba Dance
Soft Country Shuffle	Samba Enredo	Through Latin	Latin Pop Bolero
Slow Country Shuffle	Samba Brazil	Havana Latin	Soler Latin Pop
6/8 Irish Country	Brazilian Samba	Lovely Latin	Bunny Dance
Country Ballad 1	Classic Salsa	Mambo	Latin Icon
Country Ballad 2	Classic Mambo		Modern Latin Pop
Acoustic Country	Classic Cha Cha	Latin Dance	Hip Latin Pop
Country Rock	Classic Bachata	Conga Dance	Latin Groove
Country Pop 1	Classic Merengue	Pop Reggaeton	Andean
Country Pop 2	Timba	Coral Latin	
Country Pop 3	6/8 Afro	Kizomba	Jazz
Sally Groove	Bomba	Modern Reggae	Modern Big Band
Easy Country	Guajira	Reggaeton	Jazz Quartet
Arkansas Ballad	Guaguancò	Bachatango	Under My Swing
6/8 Country Ballad	Cumbia	Hot Merengue	Jazz Cha Cha
Finger Picking	Joropo	Modern Salsa	Slow Swing Brush
Slow Country	Habanera	Bomba Dance	Slow Big Band
West Coast	Guitar Bossa	Tortura Dance	Shuffle
Country Hit	Meditation Bossa	Gipsy Dance	Swing 66
Country Strum	Organ Bossa	Limbo	Latin Jazz Band
Country Quickstep	Pop Bossa	Bamba	Orchestral Swing
3/4 Country	Cool Bossa	Disco Samba	Jazz Club Medium
Modern Country	Fast Bossa	Mambo Party	Swing
Country Beat 1	Orchestral Bossa 1	Mambo Five	Dixieland
Country Beat 2	Orchestral Bossa 2	Modern Bachata	Medium Swing
Country 8 Beat	Natural Bossa	Classic Beguine	Quintet
Bluegrass	Latin Bossa	Modern Beguine	5/4 Swing
Bar Country	Bossa Lounge	Tropicana Dance	Fast Jazz Waltz
Desert Shuffle	Bossa Nova	Modern Bossa	Moon Swing
Country Shuffle	Rhumba	Disco Cha Cha	Afro-Cuban Jazz
South Shuffle	Cool Latin Jazz	Reggae 1	Swing Ballad 1
Country Boogie	Latin Big Band	Reggae 2	Swing Ballad 2
			Soft Jazz

Serenade Band	Street Soul	Just Say Funk	Christmas Waltz
Swing	Everybody Bros	Lost in Groove	Christmas Swing
Fast Big Band	Soul Bros	Nobody Funk	Last Xmas
Fast Smooth Jazz	Cool Blues	Talking Soul	Special Agent
Swing Fever	Soul	Lorber Groove	Burt's Bounce
Dual Tempo Swing	Talkin' Funk	Funk Majesty	Screen Epic March 1
Organ Blues Shuffle	Donald Mood	Funk Sugar	Screen Epic March 2
Easy Jazz Waltz	Capital Soul	Wonder Soul	Weird Movie
Easy Swing	Soul Power	Feelings Funk	Mystery Man
Buonasera Jazz	Level Funk	Amber Funk	Ritz Swing
Jazz Brush Swing	Acoustic Shuffle	Sweet Home	Tap Dance
Mood Swing	Grace Gospel	Shake Your Tail	Movie Ballad
Minnie Freeloader	Gospel Swing	Horse Sally	Safari Swing
Bigger Band	Gospel Shuffle	Chain the Fools	Hollywood 1
Big Band Shuffle	Modern Gospel 1	Gimme Love Soul	Hollywood 2
Hot Club Fox	Modern Gospel 2	Better Think	Cartoon Time
Stride	Dual Tempo Gospel	At Midnight	Love Movie
Ragtime	Love 4 All		Artie's Theme
Django	Dance To Rhythm	Movie & Show	Love Ballad
Smooth Jazz Waltz	Motown Beat 1	Spaghetti Western	Army Band
Swing Big Band	Motown Beat 2	Orchestral Movie	Western Movie
Slow Smooth Jazz	Rimshot Mood	Broadway	Theatre Swing
Slow Organ Swing	Groovy Funk	Show Time	Theatre March
Medium Jazz Waltz	Easy Funk	12/8 Action Movie	
Jazzy Lounge	Soul Ballad	Action Movie	World
Medium Organ Swing	Cool Funk	3/4 Wizard Movie	Happy Birthday
Unplugged Swing	Classic Funk	Kids Movie Ballad	Wedding March
Dukè s Ballad	Cat's Groove	Movie Swing	Libertad Tango
Classic Jazz Waltz	Funk R&B	Horror Movie	Spanish Dance
Classic Swing	Elektrik Funk	Broadway Movie FS	Hawaiian
Acoustic Jazz	Funky Sisters	Angel Voice FS	Mariachi Cumbia
	Slide Blues	Western Movie FS	Mariachi Polka
Funk & Blues	Funk Groovin'	Chillout FS	Mariachi Son
Gospel Blues	Jazzy Funk	Abstract Orchestra FS	Mariachi Waltz
Remember Funk	Little Shuffle	80's Synth FS	Mexican Waltz
Bluey Groove	Slow & Jazzy	Orchestral Ballad	Norteno
NY Rio Funk	Slow Funk	6/8 Orchestral Movie	Quebradita
Chicago Blues	Swing Hip Hop	Peter Theme	Bolero Ranchero
Live @ RMC	Kool Funk	Fifty Shades	Pizzica
Going On Soul	Blues Shuffle	Snow Swing	Quadriglia
Slap Funk	Slow Blues	Feliz Xmas	Raspa
Detroit Backbeat	Pride Blues	Want for Xmas	Rumba Napoletana

Tammurriata
Tarantella
Milonga
Sevillana
Greek Rumba
Chasapiko
Sirtaki
Alpen Schlager

Modern Schlager
Schlager Fox
Organ Fox
Banda
United States March
9/8
Halay
Oryantal

Celtic Ballad
Celtic Dream
Celtic Waltz
Scottish Reel
French March
Zouk
Ska
Casatchock

Chill Out
Kyoto Lounge
Hip Hindi Hop
Baroque
Minuetto
Orchestral Bolero

Pads

This list shows the Factory Pads as they appear in the **Pad Select** window.

Percussion

Finger Snap UpBeat
Hand Clap UpBeat
Shaker & Conga 1
Shaker & Conga 2
Shaker & Tambourine 1
Shaker & Tambourine 2
Shaker & Tambourine 3
Shaker Riff
Tambourine & Clap
Tambourine & Clap Shuffle
Tambourine Shuffle
Tambourine UpBeat
Tambourine 8th
Tambourine 16th
Conga & Bongo
Conga & Mixed
Conga & Ride
Conga & Tambourine 1
Conga & Tambourine 2
Conga & Tambourine 3
Conga Riff
Beguine Conga
Bongo & Guiro
Soft Percussion
Bossa Element
3/4 Percussion
6/8 Percussion
Cowbell & Tambourine
Cowbell Beat
Guiro & Maracas
Latin Percussion 1
Latin Percussion 2
Mambo Element 1

Mambo Element 2
Salsa Element 1
Salsa Element 2
Samba Element 1
Samba Element 2
Rhumba Element 1
Rhumba Element 2
Rhumba Percussion
Hi-Hat & Triangle
Hi-Hat UpBeat
Maracas & Claves
Mixed Percussion

Ethnic

Darbuka Loop 1
Darbuka Loop 2
Darbuka Loop 3
Darbuka Loop 4
Darbuka Loop 5
Davul Loop
Dumbek Loop 1
Dumbek Loop 2
Dumbek Loop 3
Dumbek Loop 4
Bendir Loop
Ramazan Loop
Tef Loop 1
Tef Loop 2
Tef Loop 3
Sagat Loop 1
Sagat Loop 2
Tefzil Loop
Zil Loop 1
Zil Loop 2

Piano

Piano Arpeggio 1
Piano Arpeggio 2
Piano Arp Shuffle
3/4 Piano Arp 1
3/4 Piano Arp 2
Piano Latin Rock
Piano Arp Down
Piano Arp Up
Piano Rhythm 1/8
Piano Rhythm 1/8T
Piano Accomp 1
Piano Accomp 2
Piano Accomp 3
Piano Accomp 4
Piano Accomp 5
Piano Accomp 6
Piano Salsa 1
Piano Salsa 2
Piano UpBeat 1
Piano UpBeat 2
Pno Gliss. Down White
Pno Gliss. Down Black
Pno Gliss. Up White
Pno Gliss. Up Black
Honky End

Acoustic Guitar

Steel Gtr Mute 1
Steel Gtr Mute 2
Steel Gtr Strum 1
Steel Gtr Strum 2
Steel Gtr Strum 3
Steel Gtr Strum 4
Steel Gtr Strum 5

Steel Gtr Strum 6
Steel Gtr Strum 7
Steel Gtr Strum 8
Steel Gtr Strum 9
Steel Gtr Strum 10
Steel Gtr Strum 11
Steel Gtr Strum 12
3/4 Steel Gtr Strum
Steel Gtr Arp 1
Steel Gtr Arp 2
Steel Gtr Arp 3
Steel Gtr Arp 4
6/8 Steel Gtr Arp
Steel Gtr Pick 1
Steel Gtr Pick 2
Steel Gtr Country
Nylon Gtr Strum 1
Nylon Gtr Strum 2
Nylon Gtr Strum 3
Nylon Gtr Strum 4
Nylon Gtr Strum 5
Nylon Gtr Strum 6
Nylon Gtr Strum 7
Nylon Gtr Arp 1
Nylon Gtr Arp 2
Nylon Gtr Arp 3
3/4 Nylon Gtr Arp

Electric Guitar

Electric Gtr Strum
Electric Gtr Shuffle 1
Electric Gtr Shuffle 2
Electric Gtr UpBeat 1
Electric Gtr UpBeat 2
Electric Gtr Arp

6/4 Electric Gtr Arp 1
 6/4 Electric Gtr Arp 2
 6/8 Electric Gtr Arp 1
 6/8 Electric Gtr Arp 2
 Electric Gtr 5th
 Country Gtr 1
 Country Gtr 2
 3/4 Country Gtr 1
 3/4 Country Gtr 2
 Electric Gtr Mute
 Electric Gtr Mute 8th
 Electric Gtr Funk
 Electric Gtr Funk Wah
 Distortion Mute Gtr
 Electric Gtr Wah 1
 Electric Gtr Wah 2

Orchestral

Strings 1
 Strings 2
 Strings 3
 Strings 4
 Strings 5
 Strings 6
 Strings 7
 Orch. Snare Roll
 Orch. Snare
 Orch. Tutti
 Orch. Cymbal
 Timpani 1
 Timpani 2
 Timpani 3
 Timpani 4
 Timpani Roll 1
 Timpani Roll 2
 Violin Solo
 Brass Fall
 Brass Up
 French Horns 1
 French Horns 2
 5th Intro

Spring
 Toccata
 Orch. End 1
 Orch. End 2
 Orch. End 3
 Orch. End 4
 Orch. Hit
 Orch. Harp 1
 Orch. Harp 2
 Orch. Harp 3
 Orch. Harp 4
 Orch. Harp 5

Cinematic

Atmos Melody 1
 Atmos Melody 2
 Cinematic Bang 1
 Cinematic Bang 2
 Cinematic Bang 3
 Atmos Lead
 Atom Seq
 Cinematic Impact 1
 Cinematic Impact 2
 Cinematic Impact 3
 Horror 1
 Horror 2
 Horror 3
 Horror 4
 Horror 5
 Horror 6
 Horror 7

Drum Hit

Kick 1
 Kick 2
 Kick 3
 Kick 4
 Snare 1
 Snare 2
 Snare 3
 Snare 4
 Snare Roll

Rimshot
 Brush 1
 Brush 2
 Brush 3
 Brush 4
 Sticks
 Tom 1
 Tom 2
 Tom 3
 Tom 4
 Tom 5
 Hi-Hat 1
 Hi-Hat 2
 Hi-Hat 3
 Crash 1
 Crash 2
 Ride 1
 Ride 2
 Ride Bell
 Splash
 China
 Reverse Cymbal
 Dance Kick 1
 Dance Kick 2
 Dance Snare 1
 Dance Snare 2
 Analog Kick
 Analog Snare
 Analog Tom 1
 Analog Tom 2
 Analog Tom 3
 Analog Hi-Hat 1
 Analog Hi-Hat 2
 Analog Crash
 Analog Cowbell
 Analog Tambourine
 Metronome

Percussion Hit

Timbale Hi
 Timbale Low
 Timbale Rim 1

Timbale Rim 2
 Triangle 1
 Triangle 2
 Whistle Latin 1
 Whistle Latin 2
 Agogo 1
 Agogo 2
 Windchimes 1
 Windchimes 2
 Windchimes 3
 Castanet 1
 Castanet 2
 Conga Hi
 Conga Low
 Conga Mute
 Conga Slap
 Cowbell
 Tambourine Acc. 1
 Tambourine Acc. 2
 Tambourine Open
 Tambourine Push
 Cuica 1
 Cuica 2
 Jingle Bell
 Guiro Long
 Guiro Short
 Vibra Slap
 Open Bells
 Rain Stick

Ethnic Hit

Baya 1
 Baya 2
 Darbuka 1
 Darbuka 2
 Darbuka 3
 Darbuka 4
 Darbuka 5
 Darbuka 6
 Darbuka 7
 Darbuka 8
 Bendir 1

Bendir 2	SFX	Gun Shot	Scratch 1
Bendir 3	Aah!	Heart Beat	Scratch 2
Bendir 4	Alarm	Helicopter	Scratch 3
China Gong	Applause	Hit It!	Scratch 4
Davul	Birds 1	Honk 1	Scratch 5
Dumbek 1	Birds 2	Honk 2	Scratch 6
Dumbek 2	Bubble	Horse Gallop	Saw Cut
Dumbek 3	Car Crash	Jet Plane	Storm
Dumbek 4	Car Engine	Laser Gun	Scream
Douf Rim Ak	Car Pass	Laughing	Seashore
Kup 1	Car Stop	Lion	Ship
Kup 2	Cat	Lullaby 1	Siren 1
Kup 3	Church Bell	Lullaby 2	Siren 2
Kup 4	Circus 1	Machine Gun 1	Siren 3
Hollo 1	Circus 2	Machine Gun 2	Stadium
Hollo 2	Circus 3	Military 1	Starship
Ramazan 1	Clock Set	Military 2	Thunder
Ramazan 2	Countdown	Military 3	Talk Show 1
Ramazan 3	Crickets	Military 4	Talk Show 2
Dragon Gong	Distortion Slide 1	3/4 Metronome	Talk Show 3
Rek Dom Ak	Distortion Slide 2	4/4 Metronome	Talk Show 4
Sagat 1	Dog	4/4 PreCount	Talk Show 5
Sagat 2	Door Creak	4/4 PreCount Double	Train
Tef 1	Door Slam	3/4 PreCount	Uuh!
Tef 2	Drink 1	Quiz 1	Vacuum Cleaner
Tef 3	Drink 2	Quiz 2	Whistle 1
Tef 4	Drink 3	Quiz 3	Whistle 2
Tef 5	Drink 4	Quiz 4	Wind
Tef 6	Explosion	Quiz 5	Yeah! 1
Rik 1	Footsteps 1	Phone Ring	Yeah! 2
Rik 2	Footsteps 2	Punch	
Rik 3	Gingle Bells	River	

Chord Sequences

This list shows the Factory Chord Sequences as they appear in the **Chord Sequence Select** window.

Pop & Dance

70's Disco
 70's Pop
 70's Remix
 90's Dance
 Because Pop
 Brother Dance
 ChaCha Remix
 Cowboy Dance
 Dance Revival
 EDM Happy Hour
 EDM Reggaeton
 Euro Trance
 Forever Green
 Gangnam Dance
 Hey Dance
 Hotel California
 House Class
 Love Disco
 Meneater Pop
 NU Disco
 Pachelbel Canon
 Party Anthem
 Philly Disco
 Release My Dance
 Revelation Dance
 Soul Family Pop
 Spanish Remix
 Steel Ballad
 Synth Beat
 Trap Dance
 Tritone Pop

Jazz

A Night In Tunisia
 Afro Blue
 All Of Me
 All The Things You Are
 Alone Together
 As Time Goes By
 Autumn Leaves
 Billie's Bounce
 Black Orpheus
 Blue Bossa
 Body And Soul
 But Not For Me
 Bye, Bye, Blackbird
 Cherokee
 Confirmation
 Doxy
 Fly Me To The Moon
 Footprints
 Four
 Have You Met Miss Jones
 How High The Moon
 I Hear A Rhapsody
 I Love You
 I Remember You
 I'll Remember April
 I'm Old Fashioned
 If I Were A Bell
 In A Mellow Tone
 In A Sentimental Mood
 It Could Happen To You
 Just Friends
 Misty
 My Funny Valentine

Night And Day
 Oleo
 On Green Dolphin Street
 Recordame
 Satin Doll
 Scrapple From Apple
 Solar
 St. Thomas
 Stella By Starlight
 Summertime
 Take The A Train
 The Days Of Wine And Roses
 There Is No Greater Love
 There Will Never Be Another You
 Up Jumped Spring
 What A Diff'rence A Day Made
 What Is This Thing Called Love
 Yesterdays

Latin

500 Miles High
 Agua De Beber
 Amapola
 Amor
 Besame Mucho
 Call Me
 Cast Your Fate
 Cherry Pink
 Frenesi
 Guantanamo
 How Insensitive
 It's Impossible
 Killer Joe

La Bamba
 Libertango
 Lucky Southern
 Meditation
 More
 O Barquinho
 One Note Samba
 Perfidia
 St. Thomas
 Tico Tico
 Triste
 Wave

Blues

12 7th Classic
 12 Maj Classic 1
 12 Maj Classic 2
 12 Maj Classic 3
 12 Maj End Cliche 1
 12 Maj End Cliche 2
 12 Maj Fast Blues
 12 Maj Turnaround
 12 Maj Chromatic
 12 Maj Secondary Fifth
 12 Maj Tension 9th
 12 Maj Tension 13th
 12 Min Classic 1
 12 Min Classic 2
 12 Min Classic 3
 12 Min Pop Blues 1
 12 Min Pop Blues 2
 12 Power Chords
 16 7th Classic
 16 Maj Pop Blues
 16 Maj Cadence
 16 Maj End Cliche
 16 Maj Rock'n'Roll
 16 Min Pop Blues
 24 Maj Fast Blues 1
 24 Maj Fast Blues 2

4 Bars Easy

Love '50
 Love '60
 Pop Or Without
 Wannabe
 '80 to EDM
 Alejandro
 Common Love
 Step Lower
 Step Upper
 Ascending Maj
 Ascending Min
 Andalusian
 Mostly Minor
 Get Dorian
 Mode Change
 Bailando
 Hero's Energy
 Emotional Metal

4 Bars Complex

Jazzy Love
 Diminished Love
 Isn't She Lovely
 In The Air Tonight
 Emotional Fifth
 Forever Green
 Sixth Cliche
 Augmented Cliche
 Slash Cliche
 Interlude
 Ascent Slash Maj
 Descent Slash Maj
 Descent Slash Min

4 Bars 3 Chords

3 Chord Trick 1
 3 Chord Trick 2
 3 Chord Trick 3
 Sunny Chord Trick
 I - vi - V
 ii - V - I

Tritone Substitution
 Alabama
 Stairway Down
 Tacata
 Jazzy Tension
 Suspended
 Smooth '70
 Dance '80
 EDM Drama
 Metal Drama
 Proud And Sad
 Reggae Or Rock

2 Bars 2 Chords

I - IV Major
 i - iv Minor
 i - IV Dorian
 I - V Major
 I - vi Major
 i - VI Minor
 V - i Minor
 DJ Majority
 Serenity
 Jazzy Jump
 So Tasty
 Semitone Mode
 Suspension Bounce

Circles

Diatonic Major
 Diatonic Minor
 Modulating Fifths
 Ascending Chromatic
 Falling Dominants
 Jazzy Modulations
 Jazzy Trip
 Ending Fourths
 Ending Fifths
 Tone Modulations
 4 Keys Tour
 Techno Minor

Recognized chords

The following diagrams show the main recognized chords, when the selected Chord Recognition mode is Fingered 3-Notes.

Major

3-note

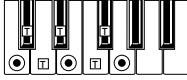

2-note

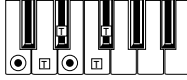

Major 6th

4-note

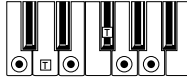

2-note



Major 7th

4-note

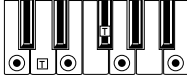

3-note



2-note



Sus 4

3-note



2-note



Sus 2

3-note



Dominant 7th

4-note

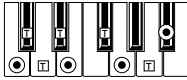

3-note

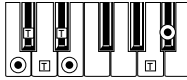

2-note



Dominant 7th Sus 4

4-note

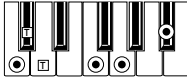

3-note



Flat 5th

3-note

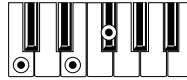

Dominant 7th ^b5

4-note

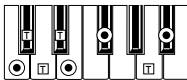

Major 7th ^b5

4-note

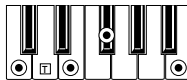













Major 7th Sus 4

4-note

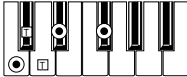
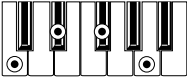
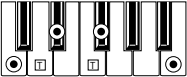
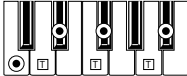

● = constituent notes of the chord

▮ = can be used as tension

<p>Minor 3-note</p> 	<p>2-note</p> 	<p>Minor 6th 4-note</p> 	
<p>Minor 7th 4-note</p> 	<p>3-note</p> 	<p>Minor-Major 7th 4-note</p> 	<p>3-note</p> 
<p>Diminished 3-note</p> 	<p>Diminished 7th 4-note</p> 	<p>Diminished Major 7th 4-note</p> 	
<p>Minor 7th ^b5 4-note</p> 			
<p>Augmented 3-note</p> 	<p>Augmented 7th 4-note</p> 	<p>Augmented Major 7th 4-note</p> 	
<p>No 3rd 2-note</p> 	<p>No 3rd, no 5th 1-note</p> 		
<p>● = constituent notes of the chord</p>		<p>□ = can be used as tension</p>	

37

Video connections

Connecting an external display

You can connect Pa5X to a TV or video monitor, to read lyrics and chords with your fellow musicians or the audience.

Use the **VIDEO > HDMI** connector to connect Pa5X to a TV set or video monitor. Please use a certified HDMI cable.



Depending on the type of video monitor to be connected, you will have to choose a different cable. You can buy the needed cables at a store that sells television equipment.

Monitor Connector	Cable
HDMI	HDMI-to-HDMI
DVI	HDMI-to-DVI
VGA	HDMI-to-VGA

Adapters from HDMI to older connector types (like SCART or Video Composite) do exist, but their compatibility with Pa5X can't be guaranteed.

■ Go to the Video Out page

- 1 If it is off, turn the instrument on.
- 2 Go to the **Settings > Menu > Audio/Video > Video Out** page.

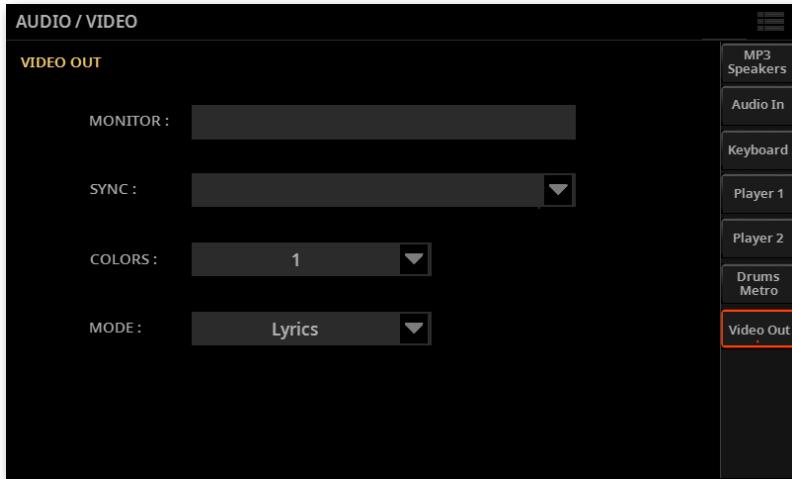

■ Check if the monitor is recognized

- > When the monitor is recognized, its name appears in the **Monitor** line. If it doesn't appear, check the connections.

■ Choose the synchronization option

In case the instrument and the external video monitor can't automatically choose the correct synchronization option, you can do it manually.

- > Use the **Sync options** parameter to choose one of the synchronization options. Choose the one that works the best with your monitor.

The chosen option will remain memorized. If you connect a different monitor, you may need to repeat the synchronization procedure described above.

■ Turn the external monitor on

- > Turn the video monitor on, and tune it on the correct AV input.

■ Set the colors

> In the same page, use the **Colors** menu to choose the preferred set of colors for the lyrics and the background.

Colors	Meaning
1...5	Color set. Try them to find the one you feel most comfortable with.

■ Choose what to display

> In the same page, use the **Mode** menu to choose what to show in the video monitor.

Mode	Meaning
Lyrics	Only Lyrics and Chords (if any) are shown in the external display. (This is the default option at startup.)
Display Mirror	The internal display is duplicated ('mirrored') to the external display.

38

Installing the options

Assembling the music stand

Follow these instructions to assemble the supplied music stand.

Assembling the music stand without the amplification bar installed

- 1 Insert the music stand into the dedicated guide on the back of Pa5X, as shown in the illustration.

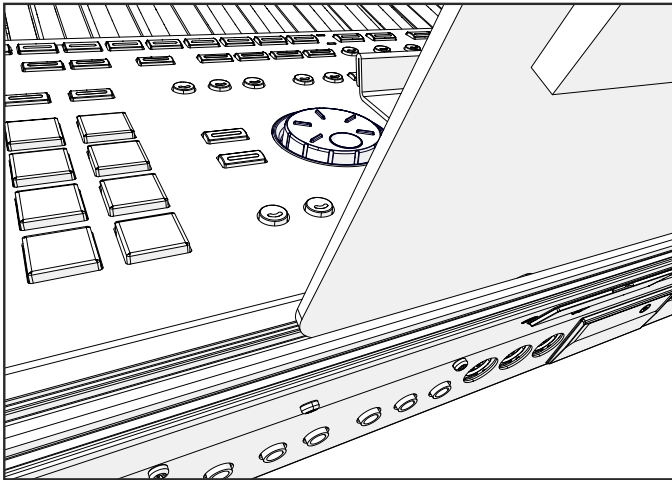

- 2 Freely adjust the music stand, by sliding it to the left or the right of the standard central position.

Assembling the music stand with the amplification bar installed

- > When the (optional) PaAS amplification system is installed, make the music stand rest over the nylon supports in front of the PaAS, as shown in the illustration.

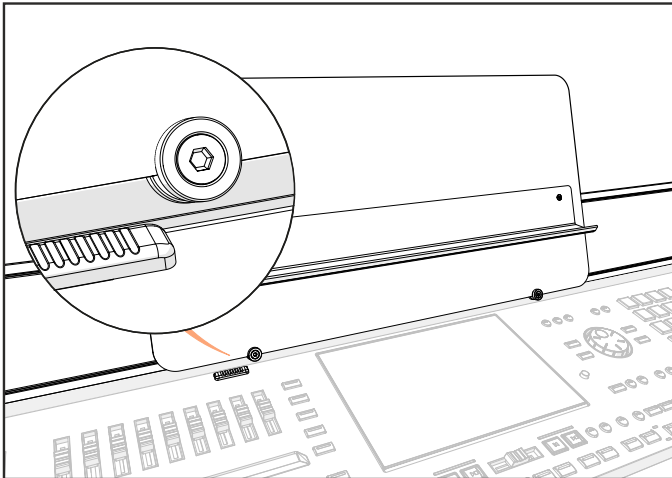
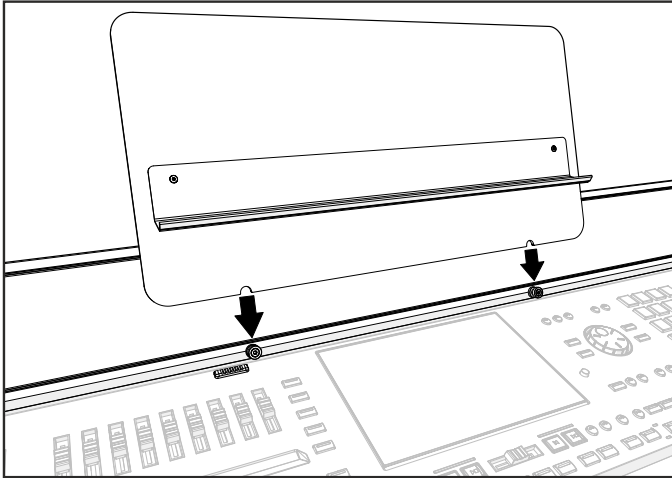

Replacing the clock battery

You can replace the clock backup battery with a standard lithium battery (model CR2032). You can buy the needed battery at a store that sells computer or electronics components. Do not use replacements other than the one indicated, or you risk to damage the instrument!

WARNING: KEEP OUT OF REACH OF CHILDREN. Battery ingestion can cause severe internal burns in just two hours. If you think batteries might have been swallowed or placed inside any part of the body, seek immediate medical attention.

Precautions

- > Installation of the battery is done at the user's own risk. KORG will assume no responsibility for any data loss, damage or injury resulting from its improper installation or use.
- > Be sure to disconnect the instrument from the AC plug, before opening it.
- > To prevent your body's static electricity from damaging the board's components, touch an unpainted metallic component before proceeding with the installation.

Installation

For installation, you will need a cross-point screwdriver (not supplied).

- 1 Disconnect the instrument from the AC power.
- 2 From the back of the instrument, use a cross-point screwdriver to unscrew the fixing screw (a).

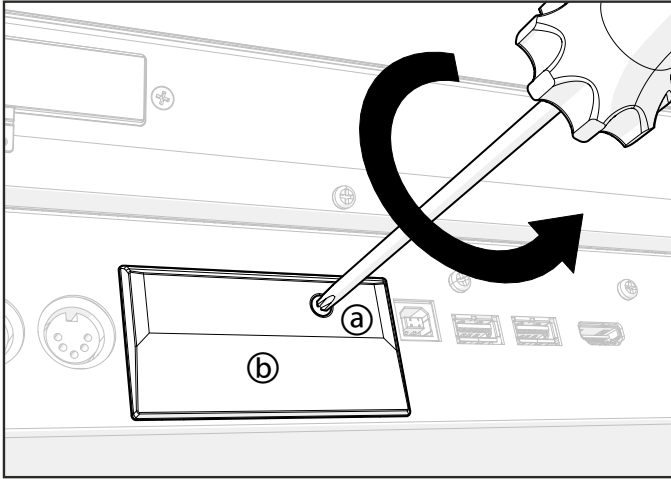

- 3 Remove the cover (b) of the expansion slot by making it rotate from the top, and keep it apart.

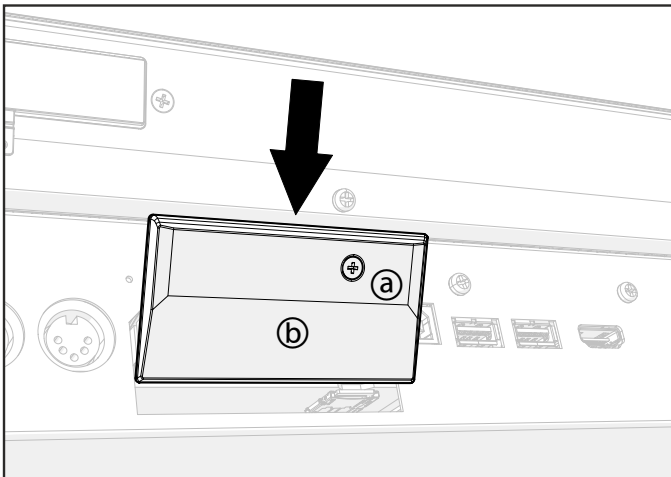

4 By pulling the attached tab (c), remove the exhausted battery (d) from the battery slot, being very careful not to let it fall inside the instrument. If the tab is not preset, use your fingernail to slightly lift and extract the battery.

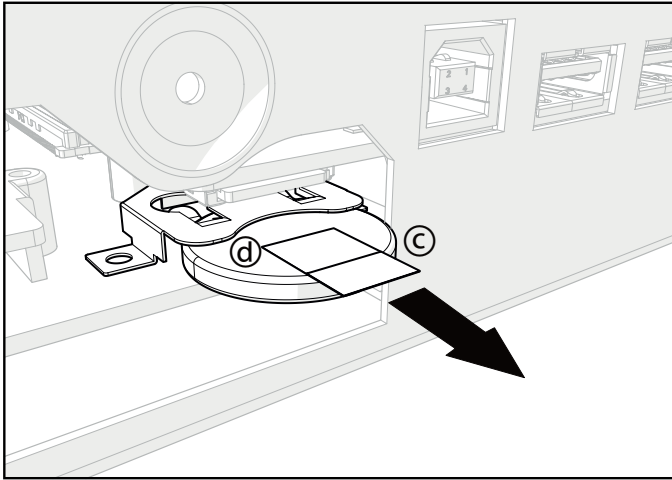

5 Insert the new battery (e) into the empty battery slot, being sure the positive (+) side is facing up. Be very careful not to let it fall inside the instrument.

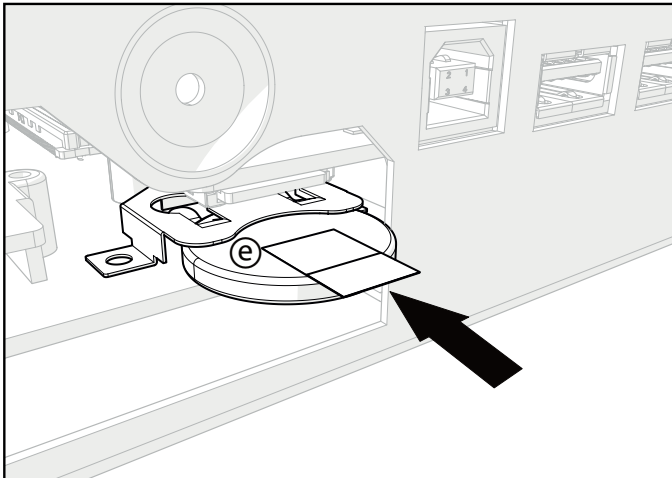

6 Replace the cover (b) to the original position, making the plastic flaps in its lower side slip under the metal casing of the instrument, as shown in the illustration.

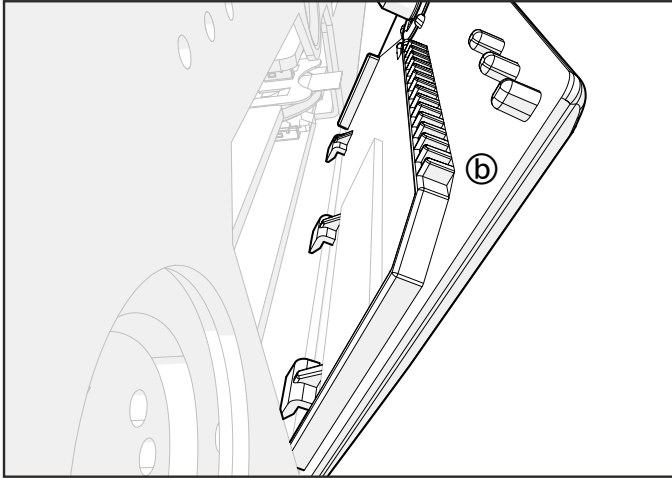

7 Rotate the cover (b) of the expansion slot so that its upper side fit the back of the instrument.

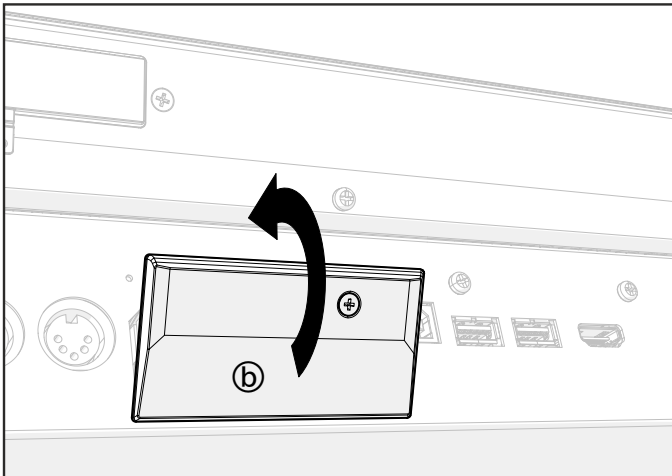

- 8 Attach the cover to the back of the instrument by fastening the fixing screw (a) with the cross-point screwdriver.

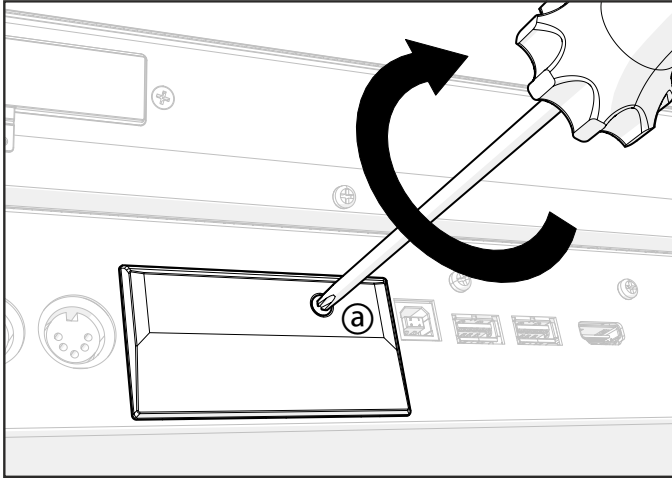

- 9 When the installation is finished, connect the power cord, and switch the instrument on again.
- 10 Go to the **Settings > Menu > General Controls > Clock & Power** page, and set the date and time.

Installing a microSD card

To expand the available onboard storage memory, you can install an (optional) microSD card. The card can be installed by the user. Do not use types of cards other than the one indicated (microSD), or you risk to damage the instrument!

You can use both slots, but we recommend to prefer the upper one for storing your data, since it is a high-speed slot.

The card must be in the FAT32 format. You can format it on a personal computer. On a Mac, use Disk Utility. In Windows, you can format a 32GB card (or smaller) with the internal utilities; for larger cards, you can use the third-party FAT32 Format utility.

Precautions

- > Installation of the microSD card is done at the user's own risk. KORG will assume no responsibility for any data loss, damage or injury resulting from its improper installation or use.
- > Be sure to disconnect the instrument from the AC plug, before opening it.

CAUTION: Removing or inserting the microSD card while the instrument is connected to the AC plug may damage the instrument and the card!

- > To prevent your body's static electricity from damaging the board's components, touch an unpainted metallic component before proceeding with the installation.

Installation

For installation, you will need a cross-point screwdriver (not supplied).

- 1 Disconnect the instrument from the AC plug.
- 2 From the back of the instrument, use a cross-point screwdriver to unscrew the fixing screw (a).

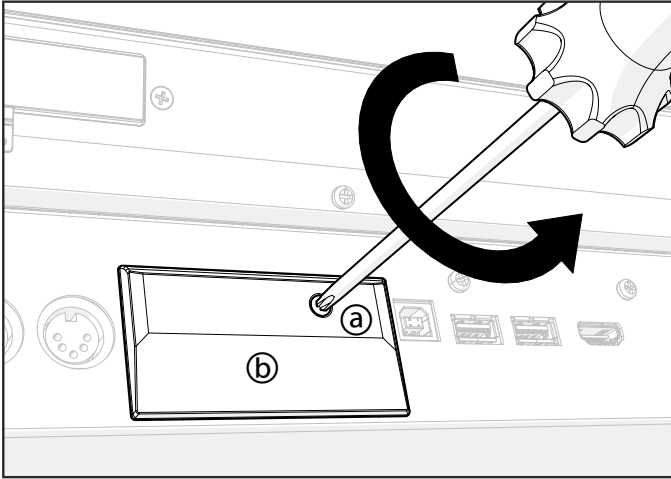

- 3 Remove the cover (b) of the expansion slot by making it rotate from the top, and keep it apart.

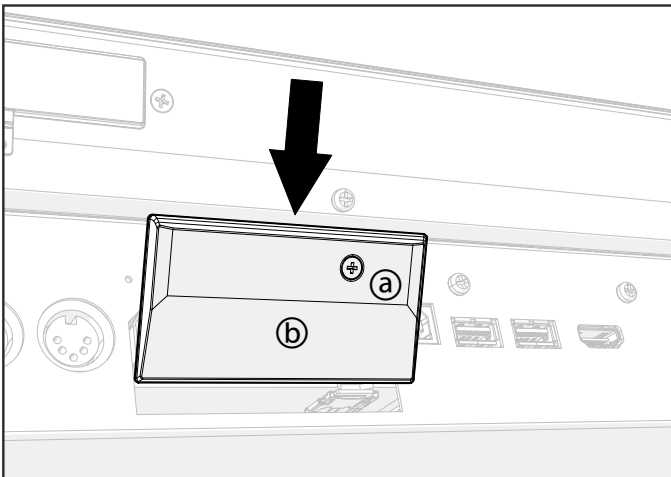

- 4 If a card is already inserted in one of the slots, remove it. Push on the upper (c) or lower (d) microSD card already installed in the slot to unlock it, and remove it, being very careful not to let it fall inside the instrument. **Note:** The upper slot (c) is high-speed, while the lower one (d) is normal speed.

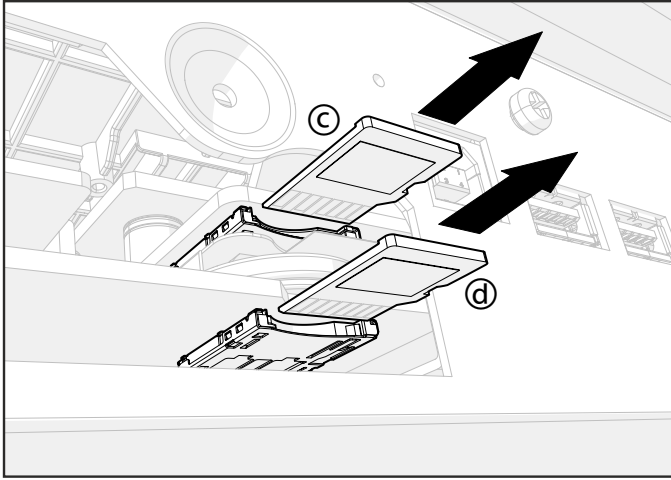

- 5 Insert the microSD card (c) or (d) into the empty card slot, being sure the connector side is facing down and toward the instrument. Gently push the card, until you hear a click sound meaning it is properly inserted. **Warning:** Be sure to insert the card correctly, or it may slip inside the instrument!

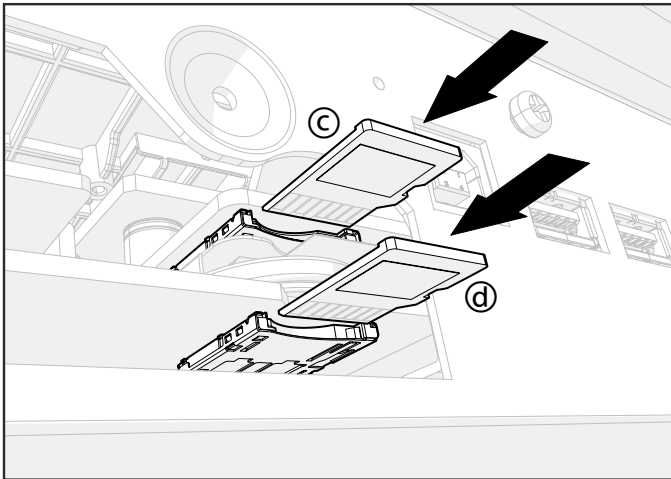

6 Replace the cover (b) to the original position, making the plastic flaps in its lower side slip under the metal casing of the instrument, as shown in the illustration.

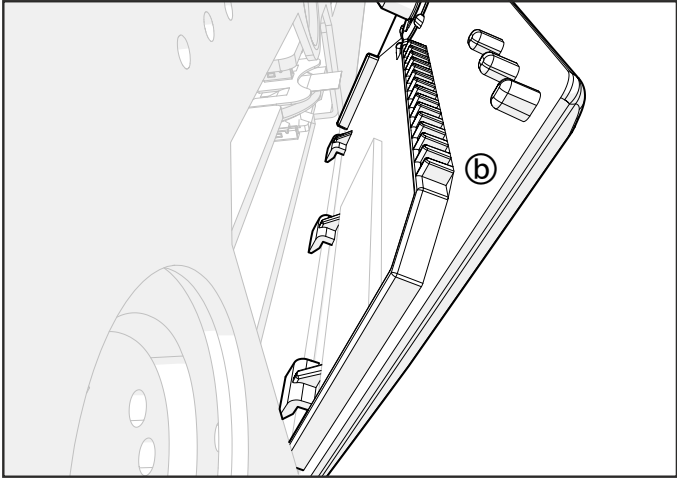

7 Rotate the cover (b) of the expansion slot so that its upper side fit the back of the instrument.

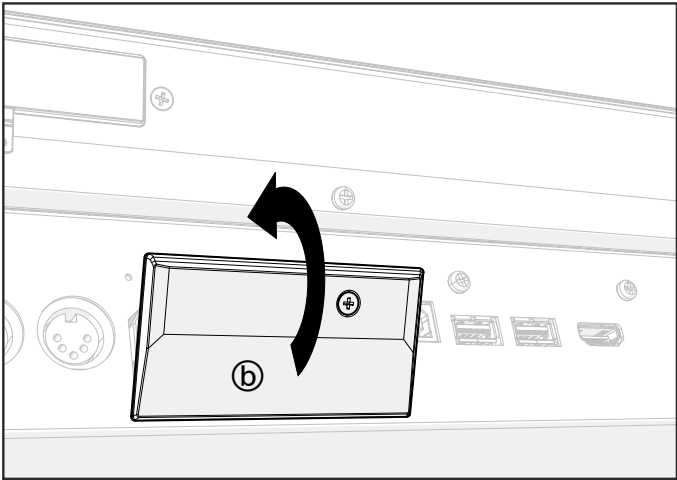

- 8** Attach the cover to the back of the instrument by fastening the fixing screw (a) with the cross-point screwdriver.

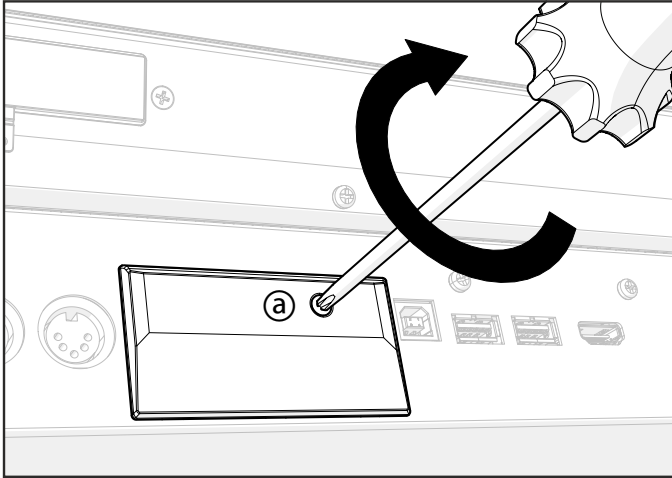

- 9** When the installation is finished, connect the power cord, and switch the instrument on again.
- 10** Access the microSD card as any other external storage device among the **Drives**.

39

Shortcuts, Solutions, Specs

Shortcuts

Shift functions

You can keep the **SHIFT** button pressed, and press another button on the control panel to directly jump to an edit page or dialog box.

Shift +	Functions
Lists	
Scrollbar Arrows	When a list is shown: Goes to Next/Previous alphabetical section of the currently selected column.
Players	
Reset/Tap	Panic; stops all notes playing, and resets all controllers.
Play/Stop (Player 1 or 2)	Sync Start or Stop of either Players.
Fade	Selects the Fade In/Out Time parameter in the Settings > General Controls > Basic page.
Style Element buttons	Selects the Fill Mode in the Home > Style Controls > Fill Mode page.
Keyboard and Pads	
Ensemble	Selects the Ensemble Type parameter in the Home > Keyboard/Ensemble > Ensemble page.
Pad (any)	Selects the Home > Pads > Pads page.
Settings	
Tempo Lock	Selects the Settings > General Controls > Lock page.
Player > Style Select button	Selects the Settings > Preferences > Style page.
Auto Fill	
Chord Scan buttons	
Memory	
Player > Song Select button	Selects the Settings > Preferences > Song page.
File	Selects the Settings > Preferences > Files page.
Transpose	
Transpose (either)	Opens the Master Transpose dialog (same parameters as in the Settings > Tuning > Transpose Control page).

Shift +	Functions
Controllers	
Assignable Switch (any)	Selects the Home > Switches > Switches page.
Control button (any)	Selects the Settings > Controllers > Sliders/Buttons page.
Control User Mode	
Slider	Proportionally changes the volume level of the Sounds/tracks of the same type (all the Upper Sounds, all the Song tracks...).
Lyrics	
Display	Load a TXT file.
Sampling	
Dial, Up/Down	Scrolls through the list of Samples or Multisamples in memory.

Long keypress

You can keep a button pressed for about one second to directly jump to an edit page or dialog box.

Long keypress	Functions
Keyboard Set Library buttons (Categories)	Opens the Save Keyboard Set to Library dialog.
Keyboard Set Library buttons (Favorite)	Opens the Settings > Menu > Controllers > Keyboard Set Favorites page.
Keyboard Set buttons (under the X-FADER)	Opens the Save Keyboard Set to Style dialog (with a User Style selected).
My Setting	Opens the Save My Setting dialog.
Book	Opens the Save SongBook Entry dialog.

Reset values

The following shortcuts recall the original or default values.

Style Play mode	
Tempo +/- (together)	Recalls the original Tempo of the Style or Song.
Transpose #/b (together)	Set the Master Transpose to 0.
Upper Octave +/- (together)	Set the Upper Octave to the original setting.

Troubleshooting

In case of problems, please check the following list to find a solution.

Problem	Solution
General problems	
Power does not turn on	Make sure that (1) the power cable is plugged into the outlet, (2) the cable is plugged into the connector on the back of the instrument, (3) and is not damaged, (4) there are no problems with the mains.
	Is the POWER indicator turned on?
	If the power still does not turn on, contact your dealer or the nearest KORG Service Center.
Power does not turn off	Press the POWER button again and keep it pressed for a few seconds. At the end, the button's indicator will turn off, and the instrument will be set to standby.
No sound	Is the MASTER VOLUME slider set to a position other than '0'?
	Is a jack inserted into the HEADPHONES connector? Unplug it.
	Check the connections to your amp or mixer.
	Make sure that all the components of the amplifying system are turned on.
	Is the Local Control parameter set to off (in the Settings > MIDI > General Controls page)? Turn it on.
Is the Attack parameter value of the selected Sound too high? Set it to a lower value, to let the sound start faster. Is the Volume parameter too low? Set it to a higher value.	
Lowest note are not played	When the SPLIT indicator is turned on, the keyboard is divided into a Lower part (lower notes, below the split point) and an Upper part (higher notes, above the split point). Is the Lower part muted? Unmute it (in the Home > Keys pane).
Wrong sounds	Do the User banks contain modified data? Load the appropriate data for the Song or the Style you wish to play.
	Has one of the User Drum Kits been replaced? Load the appropriate Drum Kits.
	Have the Styles or Keyboard Sets been replaced? Load the appropriate data.
Sound does not stop	Keep the SHIFT button pressed, and press the RESET/TAP button to send a Panic message, and turn all notes off.
	Make sure that the Damper pedal calibration is correctly set.

Problem	Solution
The selected Style or Song cannot start	Make sure that the Clock parameter is set to Internal (in the Settings > MIDI > General Controls page). If you are using the MIDI Clock of another device (like a sequencer), you must set the MIDI Clock parameter to MIDI or USB, and make sure that the external device transmits MIDI Clock data.
Does not respond to MIDI messages	<p>Make sure that the MIDI or USB cable is connected correctly.</p> <p>Make sure that the external device is transmitting through MIDI channels enabled to receive in Pa5X.</p> <p>Make sure that the MIDI IN Filters do not prevent the reception of messages.</p>
Percussive instruments are not played correctly	Make sure that the Drum track is set to Drum mode (in the Home > Track Control > Mode page) and the external device has not transposition applied.
A background noise can be heard after selecting a Keyboard Set, Style or Song	Check if the selected Keyboard Set, Style or Song did recall the effect 'Stereo Analog Record', simulating the noise of a old vinyl recording.
File related problems	
Cannot format a device	Check if the USB cable is correctly connected.
	Check if the USB device is correctly powered.
	Check if the device is inserted correctly.
	Check if the drive or card is protected. Unprotect it.
Cannot save data to a device	Check if the device is correctly formatted.
	Check if the device is inserted correctly.
	Check if the drive or card is protected. Unprotect it.
Cannot load data from a device	Check if the device is inserted correctly.
	Check if the device contains data compatible with Pa5X.
The message 'Over Current Condition Detected on USB port: please remove the USB media' appears in the display	The USB device is probably defective, due to a short circuit, and cannot be used.

Specifications

KORG Pa5X	Features
Keyboard	Pa5X 61: 61 keys (C2 – C7) Semi-weighted keys with Aftertouch
	Pa5X 76: 76 keys (E1 – G7) Semi-weighted keys with Aftertouch
	Pa5X 88: 88 keys (A0 – C8) Hammer action with Aftertouch
Case	Aluminum case with wooden side panels
Display	8" Wide capacitive color TouchView™ TFT display, 800 x 480 resolution
Operating System	Upgradable Operating System
Sound Generator	EDS-X (Enhanced Definition Synthesis-eXpanded)
	Multimode filters with resonance, 3-band EQ for each track
Polyphony	160 Voices, 160 Oscillators
Effects	Keyboard Tracks: 3 Insert Effect; 3 Master Effects
	Style/Song: 10 Insert Effects; 3 Master Effects
	Final Mastering Effects: Waves MaxxAudio® Suite
Mic Processor	Mic Processor Technology by Shift Audio
	Mic Setup: Compressor, EQ, Gate
	Four-part Harmonizer, Doubler, Filter, Mod, Delay, Reverb, AutoPitch
Guitar Processor	Guitar rack (4 effect-slots) with stompbox and amp simulation
Sounds / Drum Kits	Factory: More than 2,200 Factory Sounds
	Five multilayer Stereo Acoustic Pianos with Damper/Body Resonance, GM/XG Sound Sets, more than 130 Drum Kits including Ambient Drums and Round Robin-based Drum Kits
	User Area: 768 Sounds, 384 Drum Kits
	Digital Drawbars: 9 Footages, Percussion, Key On/Off, Leakage, Vibrato/Chorus, Rotary Speaker with Amp Simulator
	Natural Ambience Drum Sounds, Round Robin features
	Defined Nuance Control (DNC) Technology
	Quick and Full Sound Editing, Drum Family and Full Drum Kit Editing
Sampling	User PCM Sample memory: 4 GB of data, equivalent to 8 GB linear when compressed
	Loads KORG, WAV, AIFF and SoundFont™ formats
	Saves KORG, WAV and AIFF formats
	Full Edit, Time Slice, Sampling features

KORG Pa5X	Features
Keyboard Sets	Factory: More than 500 Factory Keyboard Sets, freely programmable
	Combines four Keyboard Sounds, plus Effects and settings
	Library accessible from front-panel buttons
	“My Setting” special Keyboard Set
Players	Patented XDS Crossfade Dual Player with X-Fader Balance control
	Crossfading between Songs and/or Styles
Styles	Factory: More than 600 Factory Styles, freely programmable
	Eight Style Tracks, 4 Keyboard Sets and 4 Pads per Style; Programmable Sounds, Effects and Style parameters
	Guitar Mode 2, Parallel and Fixed NTT (Note Transposition Table)
	Style Record and Event Edit
	Style Elements: 3 Intros, 4 Variations, 4 Fills, 1 Break, 3 Endings
	Style Controls: Play/Stop, Synchro Start, Synchro Stop, Tap Tempo/Reset, Auto Fill, Memory, Bass Inversion, Manual Bass, Bass & Lower Backing, Drum & Bass, Individual Style Tracks Mute, Style to Keyboard Set
Chord Sequencer	Factory: More than 200 Chord Sequences
	Chord Sequence Recorder/Player
	Chord Sequences can be saved to Style and SongBook Entries
Songs	Patented XDS Crossfade Dual Player with X-Fader Balance control
	Supported formats: MID, KAR, MP3 + Lyrics, MP3+G
	Lyrics, Score, and Chord data can be displayed on screen, or on external video monitor
	Markers with Add, Delete, Edit, Loop and AutoScroll functions
	Jukebox function
	Full-featured, 16-track Sequencer, Song Edit
MP3 Player / Recorder	Double MP3 Player and MP3 Recorder
	Records MP3 files, including Styles, MIDI Songs, MP3 Songs, Keyboard Sounds, Pads, Matrix, Microphone, Guitar, Effects
	Transpose (+6/-5 semitones), Tempo Change (±30%)
	Vocal Remover
SongBook	Fully programmable music database based on Styles, MIDI Songs (MID and KAR files), MP3 Songs with Artist and Genre tags
	Filtering and sorting options
	User definable Set Lists
Compatibility	Legacy Pa-Series models: Styles, Keyboard Sets (Performances), Sounds (Programs), Songs, Pads

KORG Pa5X	Features
Pads	Factory: More than 400 Pads
	Four Assignable Pads + Stop Buttons
	Pad Record function
Control Section	9 Assignable Sliders, 9 Assignable Buttons, Strip Display; 4 Preset + 1 User settings
Matrix Section	16 Matrix Pads, 4 Preset buttons
Style/Song Controls	Play/Stop, Go To Start, Style Select, Song Select, Xfader, Tempo +/-, Tempo Lock, Tap Tempo/Reset, Synchro Start, Synchro Stop, Fade In/Out, Chord Scan (Lower, Upper), Chord Sequence, Memory, AutoFill
General Controls	Master Volume, Octave Transpose, Master Transpose, Dial, Up/+, Down/-, Joystick (Pitch + Modulation), Ribbon, 3 Assignable Switches, Search, Shift, Keyboard Sounds On/Off, Split, Ensemble, Rec/Edit, Menu, Exit
Scale Controls	On-screen Quarter Tone and Arabic Scale, memorized in the Keyboard Sets; Presets assignable to any button or footswitch
Control Inputs	Damper Pedal; supports half-pedaling with the optional KORG DS-1H pedal
	2 Assignable Pedal/Footswitch
Audio Inputs	Mic: Mono with Gain control and Phantom Power (Combo XLR, balanced)
	Guitar: Mono with Gain control (1/4" jack, unbalanced)
	Line 1: Left/Right (1/4" jacks, balanced)
	Line 2: Stereo (1/8" mini-jack, unbalanced)
Audio Outputs	Line: Main Left/Right, Separate Outs 1/2/3/4 (1/4" jacks, balanced)
	Headphones (1/4" jack)
Video Output	HDMI connector
MIDI	IN, OUT, THRU standard MIDI connectors
	USB to MIDI, through the USB Device port
	16 User-definable MIDI Presets
USB	Type A (Host 3.0, for storage devices and controllers): 1 front, 2 rear
	Type B (Device 2.0, for personal computers and tablets): 1 rear
Storage	Internal Drive: 1 GB
	Micro SD Card (not included): Rear-panel slot with plastic cover
	USB Flash Drive (not included): Can be connected to the USB Host ports
Clock	Internal System Clock
Power Consumption	100-240 Volts, 50/60 Hz
	< 0.2 Watt in standby / 20 Watt normal / 45 Watt with PaAS installed

KORG Pa5X	Features
Dimensions (W x D x H) (without music stand, display fully lowered)	Pa5X-88: 1,262.0 x 396.4 x 146.0 mm / 49.68" x 15.60" x 5.74"
	Pa5X-76: 1,233.1 x 374.3 x 126.8 mm / 48.54" x 14.73" x 4.99"
	Pa5X-61: 1,021.1 x 374.3 x 126.8 mm / 40.20" x 14.73" x 4.99"
	PaAS (optional): 980 x 180 x 140 mm / 38.58" x 7.08" x 5.51"
Weight	Pa5X-88: 20.1 kg / 44.31 lbs
	Pa5X-76: 17.4 kg / 38.36 lbs
	Pa5X-61: 15.1 kg / 33.29 lbs
	PaAS (optional): 5.70 kg / 12.56 lbs
Accessories	AC Power Cable, Music Stand, Quick Guide manual
Options	PaAS Amplification System
	ST-SV1-BK Keyboard Stand
	EXP-2 Foot Controller, XVP-10 and XVP-20 Expression/Volume Pedals
	DS-1H Damper Pedal (supports half-pedaling)
	PS-1 Pedal Switch, PS-3 Pedal Switch
	VOX V860 Volume Pedal

Appearance and specifications are subject to change without notice due to continuous product development and improvement.



The terms HDMI and HDMI High-Definition Multimedia Interface, and the HDMI Logo are trademarks or registered trademarks of HDMI Licensing Administrator, Inc. in the United States and other countries.

Function		Transmitted	Recognized	Remarks	
Basic Channel	Default	1-16	1-16	Memorized	
	Changed	1-16	1-16		
Mode	Default		3		
	Messages	X	X		
	Altered	*****			
Note		0-127	0-127		
Number:	True Voice	*****	0-127		
Velocity	Note On	O 9n, V=1-127	O 9n, V=1-127		
	Note Off	O 8n, V=0-127	O 8n, V=0-127		
After Touch	Poly (Key)	O	O	Player data only	*1
	Mono (Channel)	O	O		*1
Pitch Bend		O	O		
Control Change	0, 32	O	O	Bank Select (MSB, LSB)	*1
	1, 2	O	O	Modulations	*1
	6	O	O	Data Entry MSB	*1
	12, 13	O	O	FX MIDI Controller 1/2	*1
	38	O	O	Data Entry LSB	*1
	7, 10, 11, 16	O	O	Volume, Pan, Expression, Ribbon	*1
	91, 93, 94	O	O	A/B Master FX Send (1, 2, 3)	*1
	64, 66, 67	O	O	Damper, Sostenuo, Soft	*1
	65, 5	O	O	Portamento On/Off, Portamento Time	*1
	71, 72, 73	O	O	Harmonic Content, EG time (Release, Attack)	*1
	74, 75	O	O	Brightness, Decay Time	*1
	76, 77, 78	O	O	Vibrato Rate, Depth, Delay	*1
	80, 81, 82	O	O	Sound Controller (1, 2, 3)	*1
	98, 99	O	O	NRPN (LSB, MSB)	*1, 2
100, 101	O	O	RPN (LSB, MSB)	*1, 3	
Program		O 0-127	O 0-127		*1
Change	True #	*****	0-127		
System Exclusive		O	O		*4
System Common	Song Position	X	X		
	Song Select	X	X		
	Tune	X	X		
System	Clock	O	O		*5
Real Time	Commands	O	O		*5
Aux Messages	All Sounds Off	O	O		*1
	Reset All Controllers	X	O		*1
	Local On/Off	X	X		
	All Notes Off	X	O		
	Active Sense	O	O		
	Reset	X	X		
Notes	<p>*1: Sent and received when MIDI Filters In and Out are set to Off in the Settings.</p> <p>*2: Drawbars settings, Sound parameters, Track EQ, Selection of SongBook Entries, Drum Kit Family settings.</p> <p>*3: LSB, MSB = 00,00: Pitch Bend range, =01,00: Fine Tune, =02,00: Coarse Tune.</p> <p>*4: Includes Inquiry, Master Volume and Transpose messages, FX settings, Quarter Tone settings. GM Mode On.</p> <p>*5: Transmitted only when the Clock Send parameter (in the Settings) is set to on.</p>				
Mode 1: OMNI ON, POLY	Mode 2: OMNI ON, MONO	O: Yes			
Mode 3: OMNI OFF, POLY	Mode 4: OMNI OFF, MONO	X: No			

IMPORTANT NOTICE TO CONSUMERS

This product has been manufactured according to strict specifications and voltage requirements that are applicable in the country in which it is intended that this product should be used. If you have purchased this product via the internet, through mail order, and/or via a telephone sale, you must verify that this product is intended to be used in the country in which you reside.

WARNING: Use of this product in any country other than that for which it is intended could be dangerous and could invalidate the manufacturer's or distributor's warranty.

Please also retain your receipt as proof of purchase otherwise your product may be disqualified from the manufacturer's or distributor's warranty.

NOTICE REGARDING DISPOSAL (EU ONLY)

If this symbol is shown on the product, manual, battery, or package, you must dispose of it in the correct manner to avoid harm to human health or damage to the environment. Contact your local administrative body for details on the correct disposal method. If the battery contains heavy metals in excess of the regulated amount, a chemical symbol is displayed below the symbol on the battery or battery package.



In case of electromagnetic radiations a temporary deterioration of the quality of audio performances may occur. A deterioration that might arise can be a sound signal emitted. This will stop when the electromagnetic disturbance ceases.

THE FCC REGULATION WARNING (FOR USA)

This equipment has been tested and found to comply with the limits for a Class B digital device, pursuant to Part 15 of the FCC Rules. These limits are designed to provide reasonable protection against harmful interference in a residential installation. This equipment generates, uses, and can radiate radio frequency energy and, if not installed and used in accordance with the instructions, may cause harmful interference to radio communications. However, there is no guarantee that interference will not occur in a particular installation. If this equipment does cause harmful interference to radio or television reception, which can be determined by turning the equipment off and on, the user is encouraged to try to correct the interference by one or more of the following measures:

- Reorient or relocate the receiving antenna.
- Increase the separation between the equipment and receiver.
- Connect the equipment into an outlet on a circuit different from that to which the receiver is connected.
- Consult the dealer or an experienced radio/TV technician for help.

If items such as cables are included with this equipment, you must use those included items.

Unauthorized changes or modification to this system can void the user's authority to operate this equipment.

DECLARATION OF CONFORMITY (FOR USA)

Responsible Party: KORG USA INC.

Address: 316 SOUTH SERVICE ROAD, MELVILLE

Telephone: 1-631-390-6500

Equipment Type: Professional Arranger

Model: Pa5X

This device complies with Part 15 of FCC Rules. Operation is subject to the following two conditions: (1) This device may not cause harmful interference, and (2) this device must accept any interference received, including interference that may cause undesired operation.

KORG

Address

KORG ITALY SpA
Via Cagiata, 85
60027 Osimo (AN)
Italy

Web

www.korg.com