

# microKORG2

## SYNTHESIZER/VOCODER

### Owner's Manual

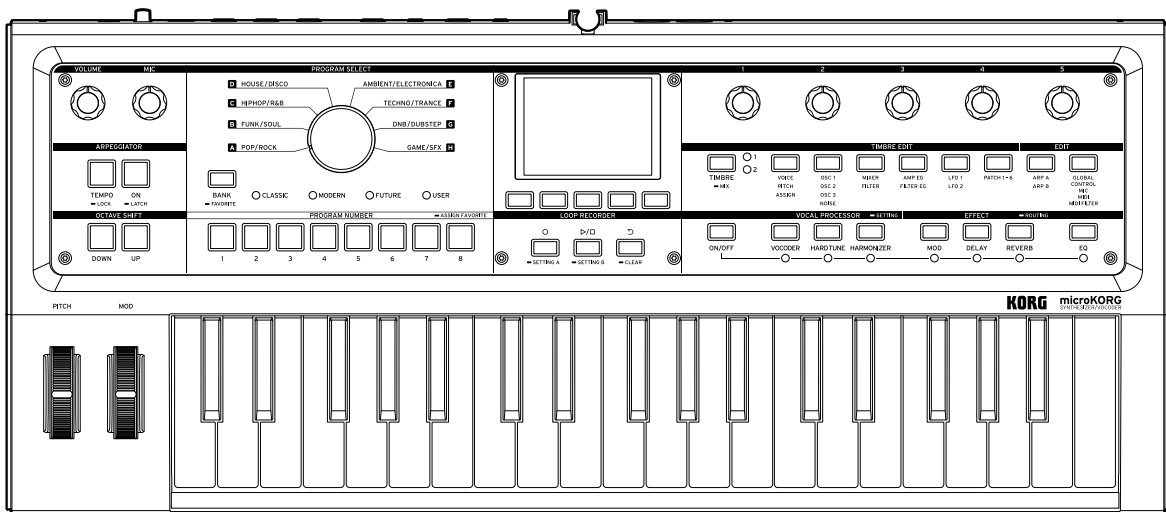

\*Before using the microKORG2, please read the Precautions (PDF) carefully to ensure proper use.

### Supplementary contents

**PDF** [Precautions/Quick Start Guide, Owner's Manual, Voice Name List](#)

**HELP** [Frequently asked questions](#)

**Prod.** [Product website](#)

Published 10/2024  
©2024 KORG INC.

# Table of contents

---

<b>Introduction .....</b>	<b>7</b>
<b>Conventions in this manual .....</b>	<b>8</b>
<b>Notes.....</b>	<b>9</b>
About the display .....	9
Data handling .....	9
Copyrights.....	9
<b>Main features .....</b>	<b>10</b>
<b>Part names.....</b>	<b>11</b>
<b>Front panel .....</b>	<b>12</b>
<b>Rear panel .....</b>	<b>16</b>
<b>Display .....</b>	<b>18</b>
Home page .....	18
Edit page.....	19
<b>Connecting and getting ready to play .....</b>	<b>21</b>
<b>Connecting to other devices .....</b>	<b>22</b>
Connecting to a power source .....	22
Connecting the included mic .....	24
Connecting from the audio outputs.....	24
Connecting to the audio inputs.....	24
Connecting a pedal switch .....	24
Connecting to a computer .....	25
Connecting to a MIDI device .....	25
<b>Turning the power on and off.....</b>	<b>26</b>
Turning the power on/off.....	26
<b>Playing the microKORG2 .....</b>	<b>27</b>
<b>Playing the programs .....</b>	<b>28</b>
Selecting programs.....	28
Using Performance Edit to modify the sound.....	28
<b>Using the vocal processors.....</b>	<b>30</b>
Adjusting the mic volume.....	30
Turning the vocal processors (vocoder, hard tune, harmonizer) on/off..	30
Controlling the pitch with a musical scale or the keyboard .....	30
Using the vocoder .....	32
Using the hard tune .....	32
Using the harmonizer.....	33
Adjusting the mic input/output .....	33

<b>Using effects and EQ .....</b>	<b>34</b>
Applying effects and EQ .....	34
Changing What is Connected to the Effects.....	34
<b>Using the arpeggiator .....</b>	<b>35</b>
Playing arpeggios.....	35
<b>Selecting favorites .....</b>	<b>36</b>
Selecting a favorite.....	36
Registering a favorite program .....	36
<b>Using the loop recorder .....</b>	<b>37</b>
Recording to the loop recorder .....	37
Playing back the loop recorder.....	37
Erasing recorded data.....	37
Editing the settings.....	37
<b>Editing .....</b>	<b>38</b>
<b>How the microKORG2 is structured .....</b>	<b>39</b>
Oscillator, filter, amp.....	39
EG, LFO, keyboard tracking, virtual patch, controllers.....	39
TIMBRE 1/2 .....	40
Effects (EFFECT) and equalizer (EQ).....	40
ARPEGGIATOR .....	40
Vocal processors (VOCAL PROCESSOR).....	40
<b>Editing a synth program.....</b>	<b>42</b>
Basic editing .....	42
Selecting a timbre .....	43
<b>Performance Edit controls.....</b>	<b>44</b>
<b>Writing data (saving) .....</b>	<b>45</b>
<b>Writing a program .....</b>	<b>46</b>
<b>Saving other data.....</b>	<b>47</b>
Saving the GLOBAL-MIDI FILTER and LOOP SETTING settings .....	47
Other settings .....	47

<b>TIMBRE section.....</b>	<b>48</b>
<b>TIMBRE.....</b>	<b>49</b>
TIMBRE.....	49
TIMBRE MIX .....	49
<b>TIMBRE EDIT section .....</b>	<b>50</b>
<b>VOICE, PITCH, ASSIGN .....</b>	<b>51</b>
VOICE .....	51
PITCH.....	53
ASSIGN.....	54
<b>OSC 1, OSC 2, OSC 3, NOISE .....</b>	<b>55</b>
OSC 1.....	55
OSC 2.....	57
OSC 3.....	58
NOISE .....	60
<b>MIXER, FILTER.....</b>	<b>61</b>
MIXER .....	61
FILTER.....	62
<b>AMP EG, FILTER EG .....</b>	<b>64</b>
AMP EG .....	64
FILTER EG .....	65
<b>LFO 1, 2.....</b>	<b>67</b>
LFO 1.....	67
LFO 2 .....	69
<b>PATCH 1-6.....</b>	<b>70</b>
PATCH 1-6 .....	70
<b>EDIT section .....</b>	<b>73</b>
<b>Arpeggiator .....</b>	<b>74</b>
ON .....	74
TEMPO .....	74
STEP On/Off .....	75
<b>ARP A, B.....</b>	<b>76</b>
ARP A .....	76
ARP B .....	77
<b>GLOBAL, CONTROL, MIC, MIDI, MIDI FILTER .....</b>	<b>80</b>
GLOBAL .....	80
CONTROL .....	81
MIC .....	83
MIDI.....	84
MIDI settings for connecting to another MIDI device or computer.....	85
MIDI FILTER .....	86

<b>VOCAL PROCESSOR section .....</b>	<b>88</b>
<b>ON/OFF.....</b>	<b>89</b>
<b>VOCODER .....</b>	<b>90</b>
VOCODER.....	90
FILTER BAND.....	91
<b>HARD TUNE .....</b>	<b>92</b>
HARD TUNE .....	92
<b>HARMONIZER.....</b>	<b>93</b>
HARMONIZER A (HARMO A) .....	93
HARMONIZER B (HARMO B).....	94
<b>VOCAL SETTING .....</b>	<b>95</b>
<b>EFFECT, EQ section.....</b>	<b>96</b>
<b>Modulation (MOD).....</b>	<b>97</b>
MOD .....	97
MOD EXTRA .....	97
Effect Type.....	98
<b>DELAY .....</b>	<b>105</b>
DELAY .....	105
DELAY EXTRA.....	105
Effect Type.....	106
<b>REVERB.....</b>	<b>108</b>
REVERB .....	108
REVERB DETAILS .....	108
Effect Type.....	109
<b>EFFECT ROUTING.....</b>	<b>111</b>
EFFECT ROUTING .....	111
<b>EQ.....</b>	<b>112</b>
EQ.....	112
<b>LOOP RECORDER section .....</b>	<b>113</b>
<b>LOOP RECORDER .....</b>	<b>114</b>
REC, PLAY/STOP.....	114
Undo/Redo.....	114
<b>LOOP SETTING A .....</b>	<b>115</b>
<b>LOOP SETTING B .....</b>	<b>116</b>

<b>Functions .....</b>	<b>117</b>
<b>INITIALIZE (INIT), COPY, MANUAL, TROPHY .....</b>	<b>118</b>
Initializing the programs and timbres (INIT) .....	118
Copying programs and timbres (COPY) .....	118
Manual / GUI Design .....	119
TROPHY .....	119
<b>Appendices .....</b>	<b>120</b>
<b>Troubleshooting.....</b>	<b>121</b>
<b>Backing up your data .....</b>	<b>123</b>
Backing up the programs and global data .....	123
Loading programs and global data .....	123
<b>Updating the system .....</b>	<b>125</b>
<b>Restoring the factory settings.....</b>	<b>126</b>
<b>OSC 1-3 Wave List.....</b>	<b>127</b>
DWGS.....	127
Oneshot .....	127
<b>Performance Edit List .....</b>	<b>128</b>
<b>PATCH 1-6 List .....</b>	<b>129</b>
Source 1, 2 .....	129
Destination.....	129
<b>Specifications .....</b>	<b>130</b>
<b>Operating requirements (for USB connection).....</b>	<b>132</b>
<b>MIDI Implementation Chart .....</b>	<b>133</b>

# Introduction

---

Thank you for purchasing the Korg microKORG2 synthesizer/vocoder.

To help you get the most out of your new instrument, please read this manual carefully.

→ [Conventions in this manual](#)

→ [Notes](#)

→ [Main features](#)

## Conventions in this manual

---

- For buttons such as those in the TIMBRE EDIT section that have multiple functions, the button is referred to using the topmost label that's listed on the panel (example: the VOICE/PITCH/ASSIGN button is referred to as the VOICE button).
- The appearance of illustrations and display content in this manual may differ somewhat from the actual product.
- The parameter values and other data shown in this manual are only for explanatory purposes, and may differ from the values shown in the display of your instrument.
- Symbols used in this manual:



Indicates an explanation you should heed to ensure that you can correctly utilize the capabilities or functionality of this unit.

*Note* Indicates an explanation that requires your attention.

*Tip* Indicates supplementary information that is useful to know.

" " Parameters shown in the display are indicated in quotation marks.



# Notes

---

## | About the display

Although the display on this product is a precision instrument that has been manufactured with an exceptional level of technical skill and adequate attention to product quality, the following characteristics are typical of displays in general, and do not indicate a malfunction.

- Dark (unlit) or always lit pixels on part of the display.
- Some variations in brightness of the display, depending on the content displayed.
- A horizontal-striped shadow when some contents are shown.
- Flickering or moire pattern visible when showing certain content.
- Afterimages visible, depending on the content.

## | Data handling

If you operate this instrument incorrectly or the unit malfunctions, the contents of the memory may be lost. Use USB mass storage mode to back up your important data to your computer. Please be aware that Korg accepts no responsibility for any damages which may result from loss of data.

Also, Korg bears no liability whatsoever for compensating the user of this product for any damages related to the loss or corruption of data saved to a computer.

## | Copyrights

- The use of copyrighted material for any use other than personal, home or other limited uses that are based on the same without the permission of the copyright holder is considered as a copyright violation, and may be liable for compensation including the payment of damages. In addition to the recording of such works, copyrights also apply to derivative works that are created by modifying the original copyrighted material. Copying, distributing or similar acts in regard to these materials are a violation of copyright. Korg assumes absolutely no liability for any damages that may arise due to copyright violations.
- You are not permitted to extract, store or record the contents that are built into or included with this product, as-is or in a manner that distinctly resembles the original data. This includes distribution of said contents or publishing them on the Internet. The copyright to the contents in this product (including but not limited to the sound programs, style data, accompaniment patterns, MIDI data, PCM sample data, audio data and operating system) belong to KORG INC., or to a third party who has acquired permission from KORG INC. You do not need permission from Korg to use the above contents for creating or performing your own works, or when recording or distributing the same.

## Main features

---

- The microKORG2 uses an analog modeling system to simulate an analog synthesizer by means of DSP (digital signal processing) technology. You can create sounds using four classic analog synth waveforms, including sawtooth and square waves, as well as 96 PCM samples and a noise oscillator. The different sections on the front panel allow you to edit the synth parameters to your liking. There is a section for the oscillators, filter, modulation, and more and you can switch between sections and use the relevant knobs to intuitively edit the sounds. You can also alter the sounds while you're playing in real time.
- The microKORG2 features three different vocal processors including a vocoder, hard tune and harmonizer.
- The vocoder uses the audio input from the microphone inputs to add a unique "talking" effect to the oscillator sound. With 16 channels, the vocoder can do more than just simulate an analog vocoder. Freely adjust the filter frequencies and change the level and pan for each band to create your own unique vocoder sound.
- The hard tune effect corrects your vocal pitch for a robot-like sound, and allows you to adjust the formant down for a thicker, lower sound or up for a thinner, higher sound.
- The harmonizer lets you shift the pitch of the voice. This lets you add harmonies to the original vocal input.
- The virtual patch allows you to create virtual connections between modulators and controllers like the filter EG, amp EG, LFOs, mod and pitch wheels, and keyboard tracking and parameters like the synth pitch, filter cutoff, and amp level for even more creative flexibility when making sounds.
- The microKORG2 includes effects to make your sounds even more refined. These include nine modulation effects, six delay effects, six reverb effects and an equalizer, all for expanding the range of your sonic creativity. The delay effects can be synchronized with the arpeggiator or external MIDI clocks, for use in a variety of situations like live performance.
- This instrument features an arpeggiator that automatically plays chords in arpeggios as you hold down the chords on the keyboard. You can select from ten types of arpeggios and configure how long each note in the arpeggio plays, the interval between notes and so on. The arpeggiator also lets you set whether notes play (on/off) over the course of up to eight steps, for an even wider range of possibilities such as the ability to change the rhythms and more.
- A loop recorder lets you record what you play when using the synth programs or the vocal processors, and play it back.
- The microKORG2 includes 256 built-in programs.

## Part names

---

→ [Front panel](#)

→ [Rear panel](#)

→ [Display](#)

# Front panel

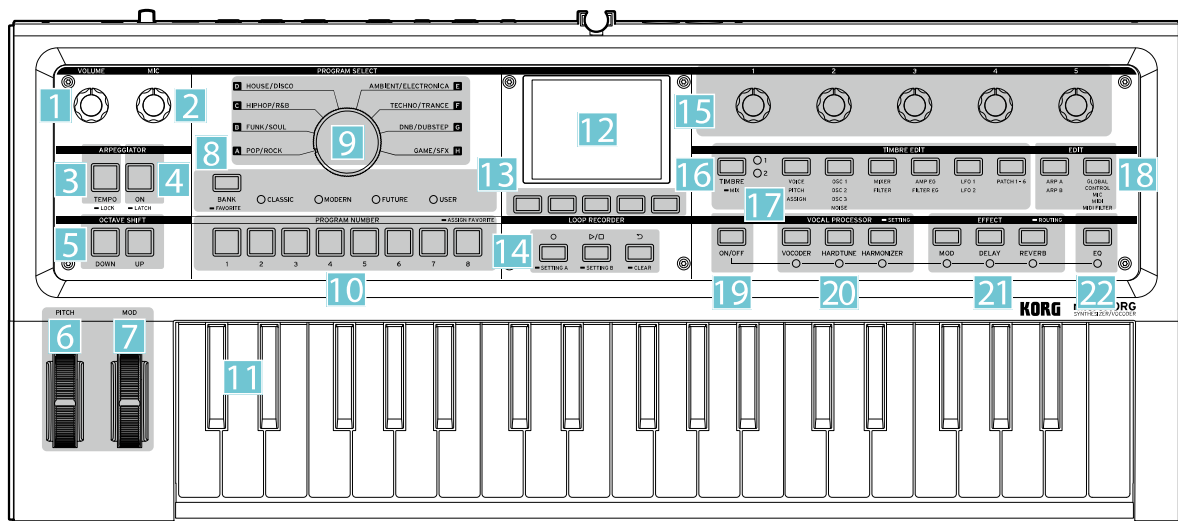

## 1 VOLUME knob

This adjusts the volume of audio output from the OUTPUT jacks (L/MONO and R) and the headphones jack.

## 2 MIC knob

Adjusts the mic volume for the mics connected to the MIC IN CONDENSER and MIC IN DYNAMIC jacks.

The MIC icon  in the top left corner of the display lights up green when audio input is detected. When the signal is clipping, the icon lights up red.

*Note:* Adjust the volume so that the MIC icon does not light up red. This knob adjusts the volume of signal after A/D conversion.

*Note:* The indicator may turn green even when there is no microphone input depending on the volume setting and operating environment, but this is not a malfunction.

*Note:* Turn the knob all the way counterclockwise to lower the volume when you're not using the mic.

## 3 ARPEGGIATOR TEMPO button

You can set the tempo by tapping this button several times at the timing you desire. This lets you control the playback speed of the arpeggiator and the loop recorder, the LFO and the various effect parameters.

Long-press the button to lock the tempo so that the current tempo stays the same even when you switch to another program (TEMPO LOCK).

*Note:* It's a good idea to lock the tempo before switching programs when you're using the loop recorder, as any changes to the tempo also change the pitch of the recorded notes.

*Note:* If the global MIDI "Clock Source" is set to "External USB/MIDI", or if it is set to "Auto" when there is an external input, the tempo setting is ignored and the instrument synchronizes to the external MIDI clock.

## 4 ARPEGGIATOR ON button

Switches the arpeggiator on/off.

Long-press the button to toggle the latch feature on/off. When the latch is set to on, the arpeggio keeps playing even after you take your hand off the keyboard.

## 5 OCTAVE SHIFT UP, DOWN switches

These shift the range of notes assigned to the keyboard in one-octave steps, up or down over a range of three octaves.

Octave	Button LEDs	Button operation
+3	Lights up red	OCTAVE UP
+2	Lights up pink	OCTAVE UP
+1	Lights up white	OCTAVE UP
Normal	Goes dark	
-1	Lights up white	OCTAVE DOWN
-2	Lights up pink	OCTAVE DOWN
-3	Lights up red	OCTAVE DOWN

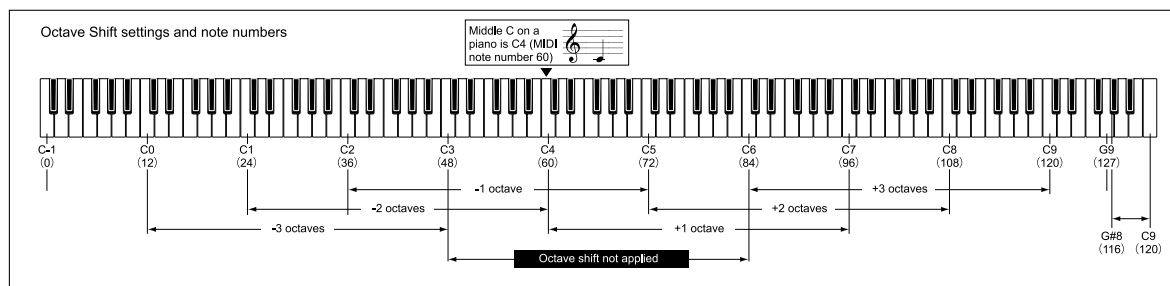

## 6 PITCH wheel

Move the wheel up (away from you) or down (towards you) to apply the effect. No effect is applied when the wheel is centered.

Normally, this wheel is used as a pitch bender, with the pitch following the direction in which you move the wheel.

By using the wheel as a virtual patch source, you can create a variety of effects in addition to those listed above. → [PATCH 1-6](#)

## 7 MOD wheel

Move the wheel up (away from you) to apply the effect. No effect is applied when the wheel is returned to zero position all the way down (when using the + setting).

Use this when you want to change the vibrato depth, change the cutoff frequency to affect the tonal color and so on.

By using the wheel as a virtual patch source, you can create a variety of effects in addition to those listed above. → [PATCH 1-6](#)

## 8 BANK button

Press this button to select a program bank (the BANK LED lights up).

*Note:* The currently selected BANK LED will blink when the PROGRAM SELECT dial position differs from the current program (for example, after selecting a program via the favorites function).

Long-press the button to turn the favorite function on, which lets you use the PROGRAM NUMBER 1-8 buttons to select a favorite program.

## 9 PROGRAM SELECT dial

Selects the program genre.

## 10 PROGRAM NUMBER 1, 2, 3, 4, 5, 6, 7, 8 buttons

Press these buttons to select a program (the button's LED lights up).

Long-press a button to register the currently selected program to that button as a favorite.

→ [Registering a favorite program](#)

These buttons are also used to turn the eight arpeggio steps on/off, adding variation to the performance. → [Turning a step on/off](#)

## 11 Keyboard

This instrument features a 37-note keyboard (mini keyboard, velocity sensitive, no aftertouch).

**Velocity:** The effect changes in relation to how hard you play the keys. Normally, the tonal color and volume changes according to how hard you play.

**Keyboard tracking:** The effect that's applied changes according to which key you play (low range vs. high range). Normally, the sounds are set so that the tonal color gets brighter as you go up the keyboard, to make the volume sound different from low to high notes and so forth.

By using the velocity and keyboard tracking as a virtual patch source, you can create a variety of effects in addition to those listed above.

## 12 Display





This is a 2.8-inch TFT IPS LCD display. The display shows various information like the current program number and parameter values.



## 13 FUNCTION 1, 2, 3, 4, 5 buttons

Use these buttons to increase or decrease the parameter values, show the oscilloscope, save the programs, initialize the data and so on.

## 14 LOOP RECORDER , , buttons

Use these buttons to record and play back the microKORG2's audio as well as audio from a mic or from the AUX IN.

When the loop recorded is stopped, press the  button to enter record standby, then the  button to start and stop recording and playback. Alternatively, you when the loop recorded is stopped press the  button to begin playback and the  button to start and stop recording. Press the  button to undo or redo a loop recording.

Long-press the  or  button to access the loop recording or playback settings pages. Long-press the  button to erase the audio data.

## 15 EDIT CONTROL 1, 2, 3, 4, 5 knobs

When on the home page, as accessed by changing the program or pressing the FUNCTION 5 button, these knobs work as Performance Edit controls. When the respective pages for TIMBRE MIX, the TIMBRE EDIT-EQ sections or the SETTING 1, 2 pages of LOOP RECORDER are shown, these knobs increase or decrease the relevant parameter values.

*Tip:* Turn the EDIT CONTROL 1-5 knobs while holding down the FUNCTION 5 button to select a parameter without changing the values. After selecting a parameter, you can use the FUNCTION 1 (DEC), 2 (INC) buttons to change the values by one step.

*Tip:* You can change how the EDIT CONTROL 1-5 knobs behave when the internal value doesn't match the position of the knob. → [Details](#)

## 16 TIMBRE button

Selects the timbre to edit.

*Note:* When using a dual program, you can select which timbre (1, 2) to edit (either LED 1 or 2 lights up). You can't switch between timbres for single programs (LED 1 and 2 go dark).

When you long-press this button, the levels and panpots (TIMBRE MIX) for timbres 1 and 2 are shown.

## 17 TIMBRE EDIT VOICE-PATCH 1-6 buttons

Use these buttons to access the section of the currently selected timbre that you wish to edit. Pressing the button multiple times will cycle through the available pages for that section.

## 18 EDIT ARP A-GLOBAL button

Use these buttons to access the arpeggiator or global settings for editing. Pressing the button multiple times will cycle through the available pages for that section.

## 19 ON/OFF button

Press the VOCAL PROCESSOR, EFFECT or EQ buttons while holding down this button to turn these functions on/off (the LEDs below the buttons light up or go dark).

## 20 VOCAL PROCESSOR: VOCODER-HARMONIZER buttons

These select the vocal processor to edit (the button in question blinks). Pressing the button multiple times will cycle through the available pages for that section.

Long-press one of these buttons to show the VOCAL SETTING page.

Press one of these buttons while holding down the ON/OFF button to turn the respective function on/off.

## 21 EFFECT: MOD, DELAY, REVERB buttons

These select the effect to edit (the button in question blinks). The displayed page will update when one of these buttons is pressed.

Long-press one of these buttons to show the EFFECT ROUTING page.

Press one of these buttons while holding down the ON/OFF button to turn the respective function on/off.

## 22 EQ button

Edits the EQ (the button blinks).

Press this button while holding down the ON/OFF button to turn the function on/off.

*Tip:* When there are multiple pages (such as with TIMBRE EDIT), press the respective button while holding down the FUNCTION 5 button to switch between pages in reverse order.

*Tip:* The icons  below the buttons indicate that you can long-press the button to access more settings.

## Rear panel

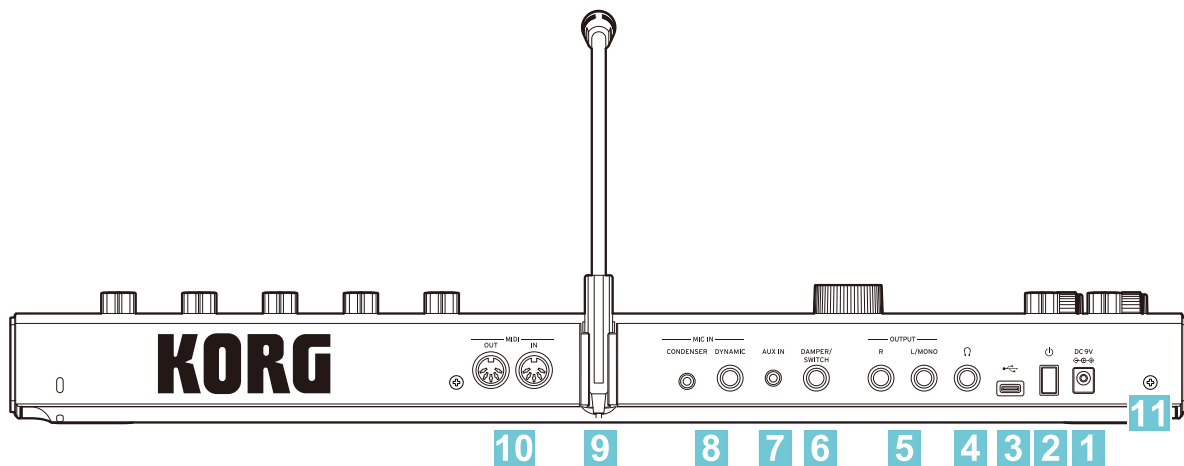

**1 DC 9V jack** → [Turning the power on/off](#)

Connect the included AC adapter here.

- ⚠ Be sure to use only the included AC adapter. Using a different AC adapter may cause a malfunction or other issues.

**2 Power button** → [Turning the power on/off](#)

Long-press this button to turn the instrument on or off.

- ⚠ Do not turn off the instrument while it is processing, such as when saving data. This may corrupt the data in the microKORG2's memory.

**3 USB port** (USB Type-C) → [Connecting to a computer](#)

Connect this port on the microKORG2 to your computer to transmit and receive MIDI data, manage program and global data, and update the system.

**4 Headphones jack** (6.3 mm stereo phone jack, unbalanced) → [Connecting to other devices](#)

Connect your headphones here.

**5 OUTPUT L/MONO and R jacks** (6.3 mm TS phone jacks, unbalanced) → [Connecting to other devices](#)

Connect your powered monitor speakers, stereo amp, mixer or other audio equipment to these jacks. If you're using a monaural connection, connect your device to the L/MONO jack.

**6 DAMPER/SWITCH jack** (6.3 mm TS phone jack) → [Connecting to other devices](#)

You can use a pedal or switch to control the damper effect or record with the loop recorder.

**7 AUX IN jack** (3.5 mm mini stereo phone jack, unbalanced)

Plug an audio player or similar external device into this jack. Adjust the volume on the external device. You can send the AUX IN input audio to the loop recorder or to an effect on the microKORG2.

**8 MIC IN CONDENSER jack** (+5 V 3.5 mm TRS mini phone jack)

Connect a condenser mic here.

**MIC IN DYNAMIC jack** (6.3 mm TS phone jack, unbalanced)

Connect a dynamic mic here.

*Note:* When connecting a mic to both the DYNAMIC and CONDENSER jacks, the CONDENSER jack input is given priority.



**9 Mic holder**

Mount the included mic onto this holder.

**10 MIDI IN, OUT connectors** → [Connecting to a MIDI device](#)

These connectors allow the microKORG2 to exchange MIDI messages with an external MIDI device.

**11 Grounding screw**

Use this terminal (screw) to connect the microKORG2 to a ground terminal. To connect, loosen the terminal and use a grounding wire to attach it to the ground terminal. After loosening the terminal (screw), be sure to tighten it again.



To avoid malfunctions, make sure the cable that you use to connect the following jacks is no more than 3 m long.

AUX IN jack, CONDENSER jack, DYNAMIC jack, headphones jack, DAMPER/SWITCH jack, USB port

# Display

## Home page

- Press the FUNCTION 5 button to show the home page.

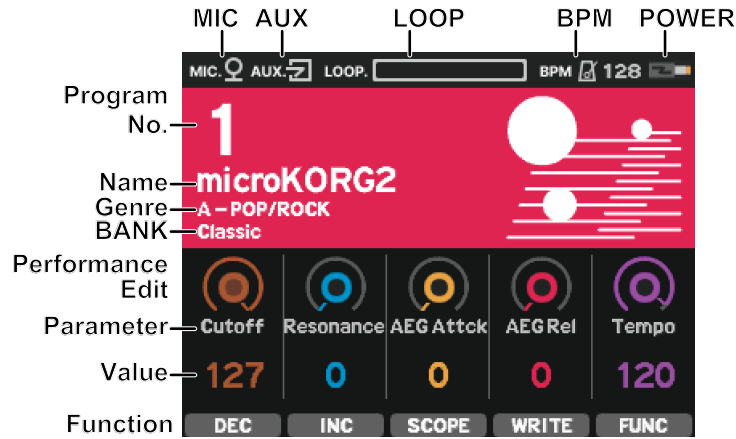

### Status

**MIC:** Indicates the input signal detected for the MIC CONDENSER and DYNAMIC jacks.  
Black: no sound; green: input detected; red: input overload

**AUX:** Indicates the input signal detected for the AUX IN jack.  
Black: no sound; green: input detected; red: input overload

**LOOP:** Indicates the recording length for the loop recorder.

**BPM:** tempo

**Power:** Hi, Low, Alert, Empty, Now Measuring  
Shows the remaining battery power in steps.

: when using an AC adapter

### Program

Shows the currently selected program number, name, genre and bank.

#### PROGRAM NUMBER

#### Program Name

#### Genre

#### BANK

→ [Selecting programs](#)

### Performance Edit

Use the EDIT CONTROL knobs 1 through 5 to make changes to the parameters assigned to each knob while you're playing, which alters the sound. → [Using Performance Edit to modify the sound](#)

### Functions

The various functions that the FUNCTION 1-5 buttons can perform.

**INC, DEC:** Increases or decreases the value of the parameter that's being edited, one step at a time. Use the EDIT CONTROL 1-5 knobs to select the parameter for which you want to change the value.

*Tip:* Turn the EDIT CONTROL 1-5 knobs while holding down the FUNCTION 5 button to select a parameter without changing the values.

**SCOPE:** Shows the oscilloscope.

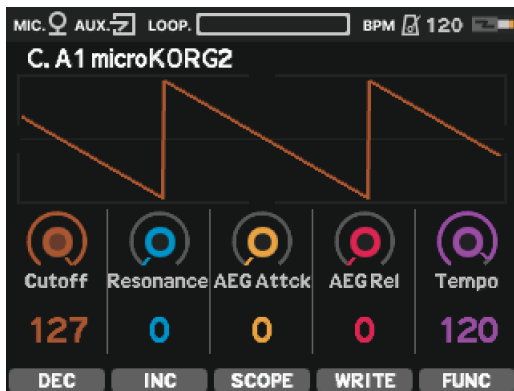

**WRITE:** Saves the current program. Press this button to show the rename, save program and cancel menu options. → [Writing a program](#)

**FUNC/HOME:** Hold down the **FUNC** (FUNCTION 5) button to access the remaining functions. → [Functions](#)

After you press a button such as TIMBRE EDIT, the FUNCTION 5 button becomes the HOME button. Press the **HOME** (FUNCTION 5) button to access the home page.

## Edit page

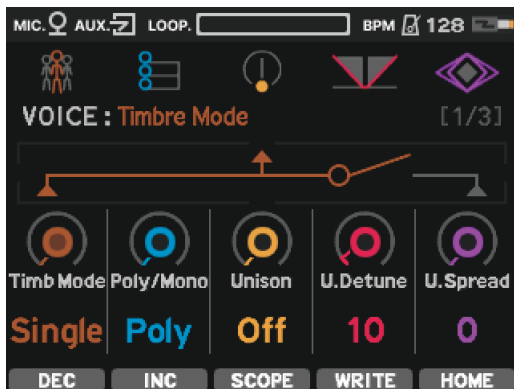

Use the respective pages to make detailed edits to the OSC, EG, LFO, effects and so on.

- 1 Press the respective buttons in the following sections to show each edit page.  
TIMBRE EDIT, EDIT, VOCAL PROCESSOR, EFFECT, EQ  
Long-press: TIMBRE [TIMBRE MIX], VOCAL PROCESSOR [VOCAL SETTING], EFFECT [EFFECT ROUTING], O, ▷/◻ [LOOP SETTING A, B]
- 2 If there are multiple pages, pressing a button multiple times will cycle through them (a tab indicating the currently selected page will appear at the top of the display).  
*Tip:* The pages switch in reverse order while you are holding down the HOME (FUNCTION 5) button.
- 3 Use the EDIT CONTROL 1-5 knobs to increase or decrease the parameter values. Use the INC and DEC buttons to increase or decrease the values by one step.

## Knobs on the display and EDIT CONTROL 1-5 knobs

The color in the center of the knobs on the display change as follows.

Gray: all knobs aside from the one you last used



Same color as the knob itself: indicates the last knob used



Slightly lighter than the knob itself: last knob used; value is equal to the saved value.



*Tip:* You can change how the knobs behave when the internal value doesn't match the position of the knob with the "Knob Mode" parameter on the EDIT CONTROL page. → [Details](#)

## Connecting and getting ready to play

---

→ [Connecting to other devices](#)

→ [Turning the power on/off](#)

## Connecting to other devices

- ⚠** Before making any connections, ensure that all of your devices and audio equipment are turned off. Operating this unit or your devices in a careless way might cause electric shock, damage your speaker system or cause a malfunction.

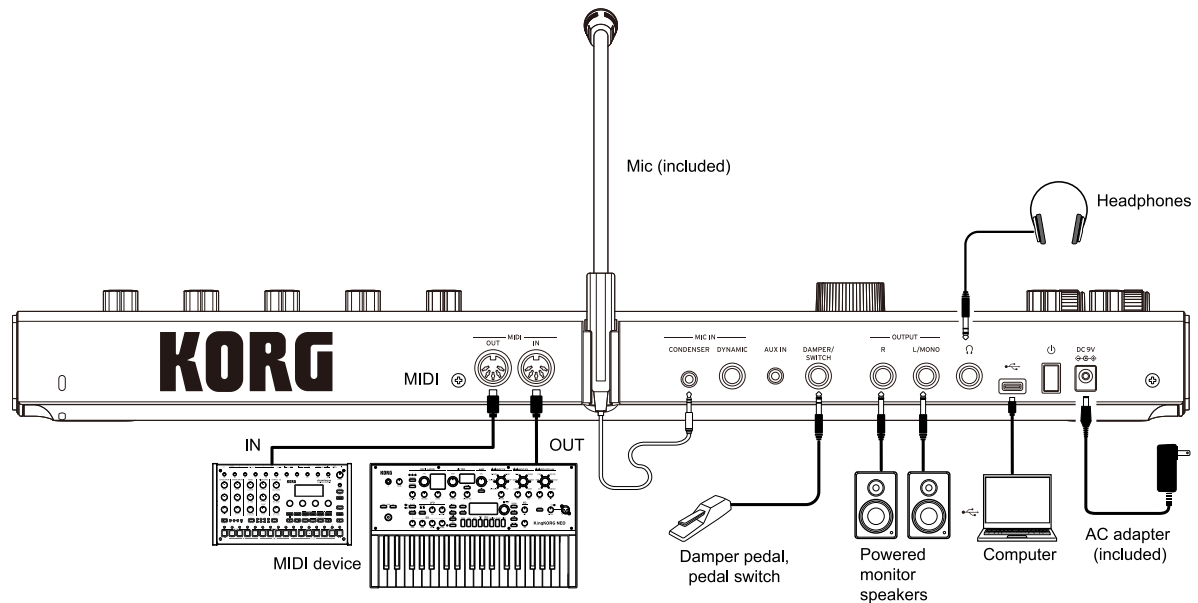

## Connecting to a power source

### Connecting the AC adapter

- 1 Connect the included AC adapter to the DC 9V jack.
- 2 After connecting, plug the AC adapter into an AC outlet.

- ⚠** Be sure to use only the included AC adapter. Using a different AC adapter may cause a malfunction or other issues.

### Installing and replacing the batteries

The microKORG2 can also operate on batteries.

*Note:* Batteries are not included, and must be purchased separately.

- 1 Make sure that the power switch on the microKORG2 is turned off, and then open the battery cover on the bottom of the case.
- 2 Insert six AA batteries (sold separately).

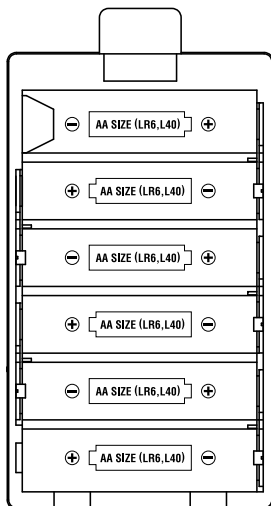

**⚠** Be sure to insert the batteries in the correct orientation.

**3** Close the battery cover.

### Setting the battery type

To ensure the correct battery level is shown, set which type of battery (alkaline or nickel-metal hydride) you are using.

Set this after you turn the power on.

**1** Press the EDIT GLOBAL button to access the GLOBAL [1/ 5] page.

**2** Turn the EDIT CONTROL 4 knob to set the battery type.

Alkaline: alkaline batteries

Ni-MH: nickel-metal hydride batteries

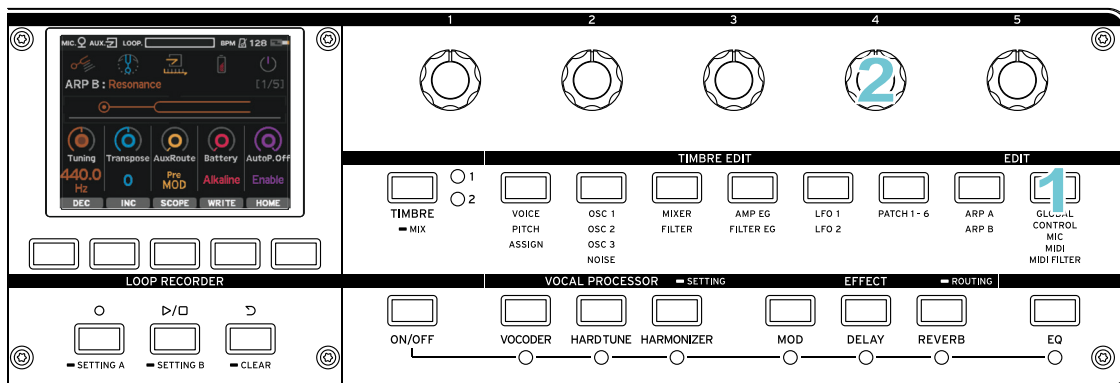

### Remaining amount of battery power

The remaining amount of battery power and related information are shown at the top right-hand part of the display. → [Status](#)

**Power:** Hi, Low, Alert, Empty, Now Measuring  
Shows the remaining battery power in steps.

: when using an AC adapter

*Note:* When the batteries are about to run out of power, the low power alert will appear. If you continue to use the microKORG2 in this state, the auto-protect feature will activate, preventing programs and global settings from being saved. We recommend that you either replace the batteries as soon as possible or connect an AC adapter. If you wish to save the settings you're now editing even while in this state, connect an AC adapter and perform the write operation.

## Connecting the included mic

Connect the included mic to the mic holder. While holding the base of the included mic, align the protrusion on the mic with the guide of the mic holder, and push the mic into the holder. Do not use excessive force.

Connect the included mic to the MIC IN CONDENSER jack.

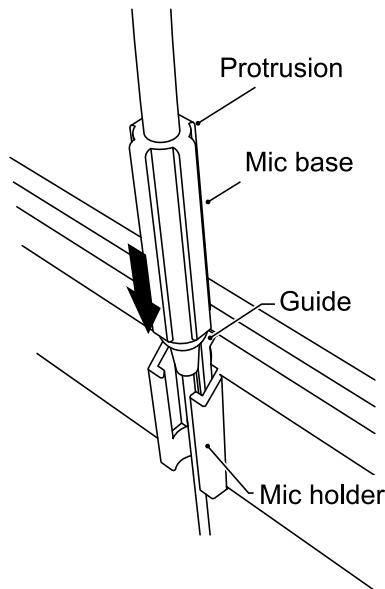

**⚠** If you want to use a mic other than the one that was included, connect it to the appropriate jack.

## Connecting from the audio outputs

Connect the OUTPUT L/MONO and R jacks of the microKORG2 to the input jacks of your mixer, powered monitor speakers or other audio equipment. We recommend that you connect the output of the microKORG2 in stereo, to take advantage of its sonic capabilities. If you're using a monaural connection, connect from the L/MONO jack.

When using headphones, connect them to the  (headphones) jack.

## Connecting to the audio inputs

If you want to use the vocoder, hard tune and harmonizer effects with a mic other than the one that's included, plug the mic into the MIC IN CONDENSER jack or the MIC DYNAMIC IN jack. → [Input/output jacks](#)

To input the audio from an external source such as an audio player, plug the device into the AUX IN jack. Adjust the volume on the external device.

## Connecting a pedal switch

Connect your accessories such as a damper pedal or pedal switch (sold separately) to the DAMPER/SWITCH jack. You can use a pedal or switch to control the damper effect or record with the loop recorder.

### Configuring the pedal functions

- 1 Press the EDIT GLOBAL button to access the CONTROL [2/5] page.
- 2 Turn the EDIT CONTROL 2 knob to set the pedal function.



→ [CONTROL](#)

 Avoid plugging or unplugging devices and accessories into or out of the jacks when this instrument is on.

## | Connecting to a computer

Connect the microKORG2 to your computer when you want to control your computer's DAW software or sound source from the keyboard, or trigger the microKORG2's sound generator from your DAW or similar software.

- Connect the  (USB-C) port to your computer with a USB cable.

*Note:* Depending on your setup, some MIDI-related settings like MIDI channel may require some adjustment.

→ [MIDI settings for connecting to another MIDI device or computer](#)

### Operating requirements

See the Korg website for the latest information on OS and driver support.

<https://www.korg.com/support/os/>

### Application settings

To use this instrument with your computer, you must configure the MIDI input/output and other settings in the application you are using. → [MIDI](#)

Refer to the application's owner's manual for detailed usage instructions.

## | Connecting to a MIDI device

Use a MIDI connection when you want to control an external MIDI tone generator from the keyboard or the controllers on the microKORG2, or when you want to trigger the microKORG2's sound generator from another MIDI keyboard or similar device. → [MIDI](#)

- If you want use the microKORG2 to control an external MIDI device, connect the microKORG2's MIDI OUT connector to the external MIDI device's MIDI IN connector with a MIDI cable.
- To control the microKORG2 from an external MIDI device, connect the MIDI OUT connector of the external MIDI device to the MIDI IN connector of the microKORG2 with a MIDI cable.
- To use the microKORG2 keyboard to record a performance to an external MIDI sequencer or computer (connected via a MIDI interface) and then listen back to that performance using the microKORG2, the MIDI OUT connector of the microKORG2 needs to be connected to the MIDI IN connector or the external MIDI sequencer or computer and vice versa.

*Note:* Depending on your setup, some MIDI-related settings like MIDI channel may require some adjustment.

→ [MIDI settings for connecting to another MIDI device or computer](#)

*Note:* You may not be able to exchange the MIDI system exclusive messages of the microKORG2 with certain MIDI interface devices.

*Tip:* Connecting via USB port is handy when you want to connect the microKORG2 to your computer.

# Turning the power on and off

## Turning the power on/off

*Note:* Before turning the power on, make sure that the volume is turned all the way down on your other devices.

If you've connected equipment such as monitor speakers, turn the power on/off in the following order.

### Turning the power on

- 1 Turn the volume all the way down on the devices you want to connect the microKORG2 to.
- 2 Long-press the power button on the microKORG2 to turn the instrument on.
- 3 Turn on your external output devices such as monitor speakers.

### Turning the power off

- 1 Turn the volume all the way down on all devices.
- 2 Turn off your external output devices such as monitor speakers.
- 3 Long-press the power button on the microKORG2 to turn the instrument off.

**⚠** Do not turn off the instrument while it is processing, such as when saving data. This may corrupt the data in the microKORG2's memory.

### Auto power-off function

The microKORG2 automatically turns off if is not operated for two hours (auto power-off). This setting can be adjusted.

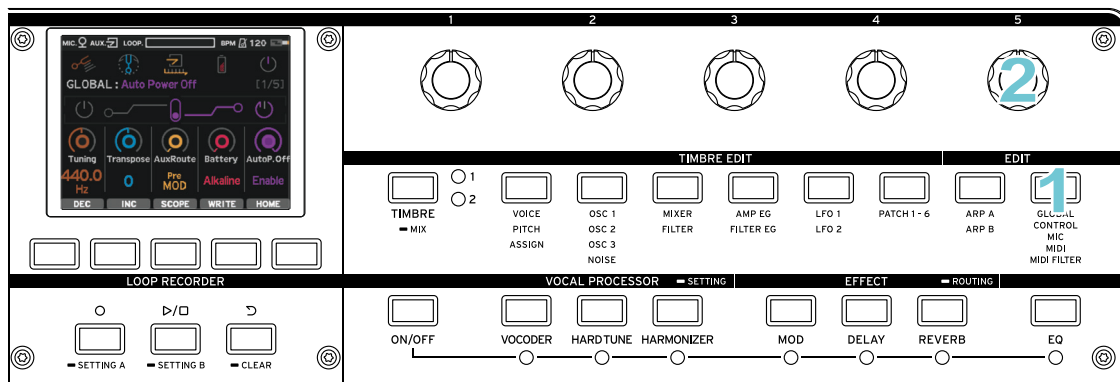

- 1 Press the EDIT GLOBAL button to access the [1/5 GLOBAL] page.
- 2 Turn the EDIT CONTROL 5 knob to make the setting.

**Disable:** disables the setting

**Enable:** enables the setting (the power turns off automatically if two hours elapse without any user input)

Auto power-off does not activate in the following conditions.

- When you are operating the front panel buttons or knobs, playing the keyboard or using other controls
- When you are using the arpeggiator in latch mode
- When the loop recorder is playing back or recording
- When an input signal is being received from the MIC IN or AUX IN jacks
- When receiving MIDI messages other than MIDI clock

# Playing the microKORG2

---

- [Playing the programs](#)
- [Using the vocal processors](#)
- [Using effects and EQ](#)
- [Using the arpeggiator](#)
- [Selecting favorites](#)
- [Using the loop recorder](#)

# Playing the programs

## Selecting programs

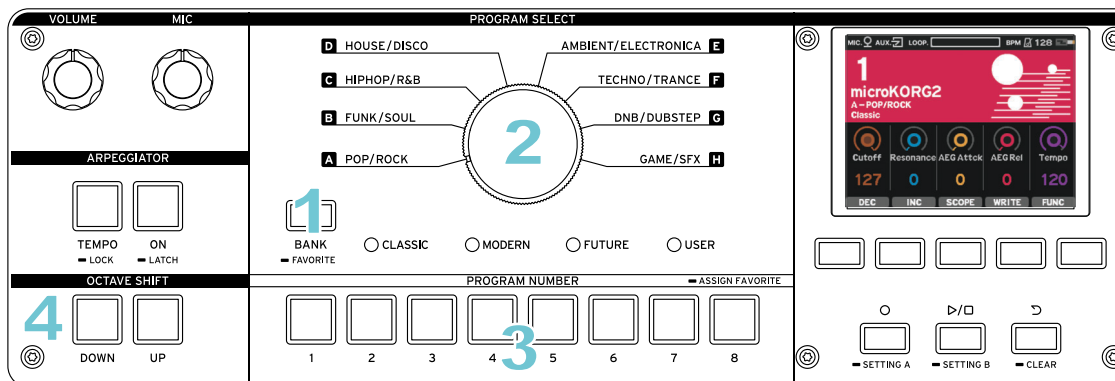

- 1 Press the BANK button to select a program bank (from CLASSIC to USER).
- 2 Turn the PROGRAM SELECT dial to select a program genre (from POP/ROCK to GAME/SFX).
- 3 Press a PROGRAM NUMBER button between 1 and 8 to select the program number.  
The program switches right when you change the bank, genre or number.
- 4 Now, play the keyboard to make some music.  
You can use the PITCH wheel, MOD wheel, OCTAVE SHIFT UP and DOWN buttons, the Performance Edit controls and so on to control the sound.

## Using Performance Edit to modify the sound

The Performance Edit controls are displayed on the home page to make it easy to tweak your sound with EDIT CONTROL knobs 1-5 while playing. Although these are pre-assigned to commonly used parameters like Cutoff and Resonance, they can all be freely changed on the TIMBRE EDIT ASSIGN page.

→ [Performance Edit controls](#)

### Using Performance Edit

- 1 Select a program or press the FUNCTION 5 button to show the home page.
- 2 Play the microKORG2 and use EDIT CONTROL knobs 1-5 to change the sound.

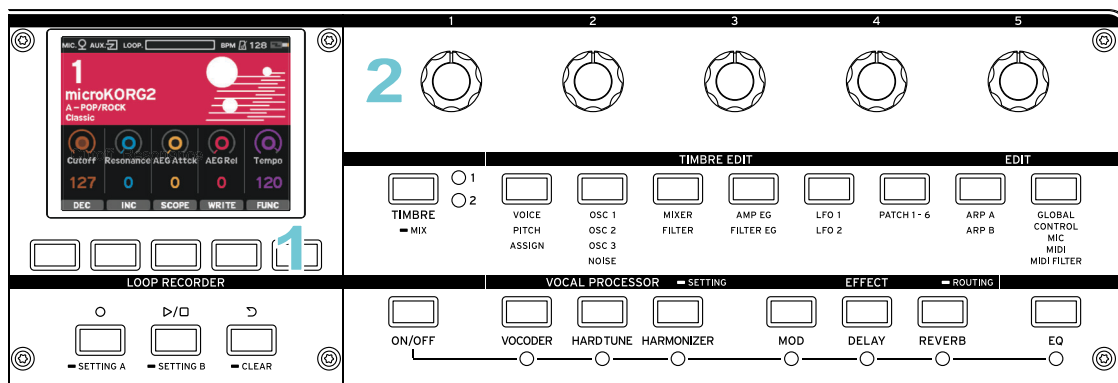

See "Performance Edit List" for the parameters that you can assign.  
Refer to the parameter descriptions to learn how the parameters modify the sound.  
Here are some examples.

**Cutoff:** → [Details](#)

**Resonance:** → [Details](#)

**AMP EG Attack (AEG Attck):** → [Details](#)

**AMP EG Release (AEG Rel):** → [Details](#)

**Tempo:** → [Details](#)

*Tip:* You can assign almost any parameter from the TIMBRE EDIT and EDIT sections to the Performance Edit controls.

*Note:* The sounds you modify using Performance Edit can be saved. → [Writing a program](#)

*Note:* You can change which parameters are assigned to the Performance Edit controls.  
→ [Performance Edit controls](#)

## Using the vocal processors

### Adjusting the mic volume

- 1 With the microKORG2 turned off, connect the included mic. → [Connecting the included mic](#)
- 2 Turn the microKORG2 on.
- 3 While vocalizing into the mic, use the MIC knob to adjust the mic volume.

*Note:* Adjust how loudly you vocalize into the mic so that “MIC 

### Turning the vocal processors (vocoder, hard tune, harmonizer) on/off

- 1 Press the VOCAL PROCESSOR (VOCODER, HARD TUNE and HARMONIZER) button while holding down the VOCAL PROCESSOR ON/OFF button to turn the respective vocal processors on/off. The button’s LED lights up when the respective vocal processor is on.

*Note:* When the VOCODER, HARD TUNE or HARMONIZER buttons blink, this means that the vocal processor in question is being edited.

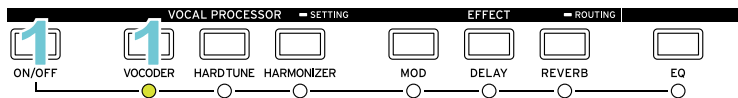

### Controlling the pitch with a musical scale or the keyboard

*Note:* Check this setting if the vocal processor isn’t working as expected.

The pitch of the vocal processor is controlled by the audio signal that’s detected from the mic, or by what you play on the keyboard.

- 1 Long-press a VOCAL PROCESSOR button (VOCODER, HARD TUNE, HARMONIZER) to show the VOCAL SETTING page (all three buttons blink).
- 2 Use the EDIT CONTROL 1-3 knobs to adjust the values.

#### Scale/KBD: Scale

- **Scale/KBD:** when set to “Scale”, the vocal pitch is corrected to match the “Scale Key” and “Scale Type” you set
- **Scale Key:** sets the scale tonic
- **Scale Type:** sets the scale to use

#### Scale/KBD: Keyboard

- **Scale/KBD:** when set to “Keyboard”, the vocal pitch is corrected to match the keys you play on the keyboard

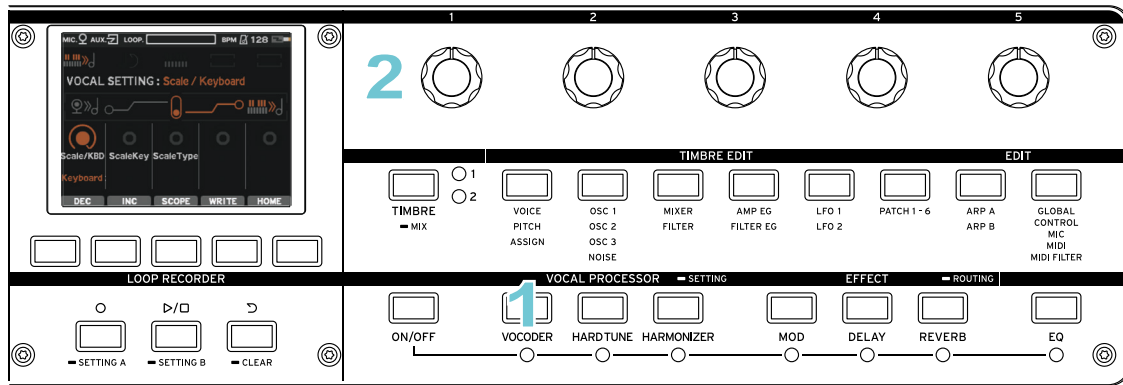

## | Using the vocoder

The vocoder adds the characteristics of sounds like the sound of an external input source such as a person's voice (modulator) to sounds such as that of an oscillator (carrier), and outputs the result. Vocoderes are most often used by letting the player speak or sing into a mic and play chords on the keyboard, creating the impression that an instrument is speaking or singing. When using SCALE mode, you can also control the pitch of the microKORG2 with your voice.

- 1 Press the VOCODER button while holding down the ON/OFF button to turn the vocoder on/off. The VOCODER ON/OFF LED lights up when the vocoder is on.
- 2 Play the keyboard while vocalizing into the mic (when Scale/KBD on the VOCAL SETTING page is set to "Keyboard").  
To hear different vocoder effects, try vocalizing in different ways and changing the chord that you play.  
Also, try simply vocalizing into the mic (when Scale/KBD on the VOCAL SETTING page is set to "Scale").

### Adjusting the vocoder

- 1 Press the VOCODER button to show either the VOCODER page or the FILTER BAND page. (The VOCODER button blinks.)  
Use the VOCODER page to set the vocoder mix, carrier-side bandpass filter, and modulator-side envelope follower parameters. → [VOCODER](#)  
On the FILTER BAND page, set the output level and panpot (stereo position) for the 16 filters on the carrier side. → [FILTER BAND](#)
- 2 Use the EDIT CONTROL 1-5 knobs to adjust the values.
- 3 Use each button and the respective EDIT CONTROL 1-5 knobs in TIMBRE EDIT to set the parameters for each oscillator section.

*Tip:* While vocalizing into the mic, you can "freeze" the current tone of the vocoder by setting Env Follower Sens to "Hold". This allows you to continue to play the current vocoder sound, even when you are not vocalizing. This tone will be saved when you write the program to memory.

## | Using the hard tune

This feature is used to correct the vocal pitch. Use this to create robot-like voices, or to adjust the formant for a thicker, lower vocal sound or for a thinner, higher sound.

- 1 Press the HARD TUNE button while holding down the ON/OFF button to turn hard tune on/off. The HARD TUNE ON/OFF LED lights up when hard tune is on.
- 2 Now, sing into the mic (when Scale/KBD on the VOCAL SETTING page is set to "Scale").  
You can also sing while playing the keyboard (when Scale/KBD on the VOCAL SETTING page is set to "Keyboard").

### Adjusting the hard tune effect

- 1 Press the HARD TUNE button to display the HARD TUNE page (the HARD TUNE button blinks).
- 2 Use the EDIT CONTROL 1-3 knobs to set the parameters. → [HARD TUNE](#)



## | Using the harmonizer

This shows how to shift the pitch of your vocals and add that voice as a harmony to the original vocals for output.

- 1** Press the HARMONIZER button while holding down the ON/OFF button to turn the harmonizer on/off.  
The HARMONIZER ON/OFF LED lights up when the harmonizer is on.
- 2** Now, sing into the mic (when Scale/KBD on the VOCAL SETTING page is set to "Scale").  
You can also sing while playing the keyboard (when Scale/KBD on the VOCAL SETTING page is set to "Keyboard").

### **Adjusting the harmonizer**

- 1** Press the HARMONIZER button to show either the HARMO A page or the HARMO B page (the HARMONIZER button blinks).
- 2** Use the EDIT CONTROL 1-5 knobs to set the parameters. → [HARMONIZER](#)

## | Adjusting the mic input/output

On the EDIT GLOBAL MIC page, you can adjust how much noise is cut with there is no input from the mic, as well as the input/output response time. → [MIC](#)

## Using effects and EQ

---

### | Applying effects and EQ

The output from synth programs or from the vocal processor is sent through the following signal chain to apply effects: modulation effect (MOD) → delay effect (DELAY) → reverb effect (REVERB) → equalizer (EQ).

You can edit the modulation type effects and the delay and reverb effects to create the sound you want, in the same way as when editing the filter or amp.

- 1 To turn each effect on/off, press the button for the respective effect (MOD, DELAY, REVERB, EQ) while holding down the ON/OFF button.

The respective button's LED lights up when its effect is on.

- 2 Press the EFFECT MOD, DELAY, REVERB button or EQ button to adjust the settings. The respective page is shown.

- 3 Use the EDIT CONTROL 1-5 knobs to adjust the values.

You can use effects to modify the sound in a variety of ways. For details on each effect's parameters, click on the effect type that you are interested in below.

Modulation effect (MOD FX): choose from nine types of effects. → [Modulation \(MOD\)](#)

Delay effect (DELAY FX): choose from six types of effects. → [DELAY](#)

Reverb effect (REVERB FX): choose from six types of effects. → [REVERB](#)

Equalizer (EQ): this is a two-band equalizer. → [EQ](#)

*Note:* If you raise the equalizer gain too much, the output may distort.

### | Changing What is Connected to the Effects

To change how timbres 1 and 2 and the microphone input or vocal processor output is routed to the effect processors, please follow the instructions below. The effects are connected in the following order: modulation effect (MOD) → delay effect (DELAY) → reverb effect (REVERB) → equalizer (EQ).

- 1 Long-press either the MOD, DELAY or REVERB button to access the EFFECT ROUTING page.
- 2 Use the EDIT CONTROL 1-3 knobs to set which effect connects to timbres 1 and 2 as well as to the audio signal input from the MIC jack.

*Tip:* You can set where the AUX IN jack input signal is connected to with the Aux Routing parameter (AuxRoute) on the EDIT GLOBAL page.

# Using the arpeggiator

## Playing arpeggios

The arpeggiator function automatically plays all the notes of a held chord as individual events in a repeating rhythmic pattern. The microKORG2's arpeggiator has ten arpeggio types and a number of parameters like the note length (gate time) that can be adjusted. The "Step Arpeggiator" functionality also allows you to instantly turn up to eight steps on and off to create an even wider range of performance possibilities.

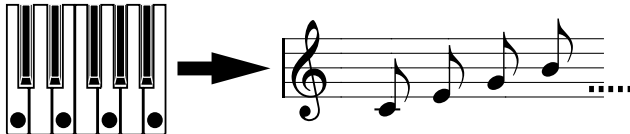

When you hold down a chord, the notes sound as shown at right. (Type: Up)

- 1 Press the ARPEGGIATOR ON button to turn on the arpeggiator.
- 2 Hold down a chord on the keyboard to make the arpeggio play.
- 3 Set the tempo by pressing the TEMPO button a number of times.
- 4 Long-press the ARPEGGIATOR ON button to turn the latch on. When the latch is on, the arpeggiator keeps playing even after you release the keys.

## Modifying the arpeggio

- 1 Press the EDIT ARP A button to select the ARP A, B page.
- 2 Use the EDIT CONTROL 1-5 knobs to change the way that the arpeggiator plays. This lets you add a swing feel to the rhythm, change the arpeggio type as well as the number of steps. See the following page for details. → [ARP A, B](#)

## Turning a step on/off

- Press the PROGRAM NUMBER 1-8 buttons to turn on/off the arpeggio notes for up to eight steps. Pressing a button to turn off the LED changes the note for that step into a rest, which makes the arpeggiator play differently.

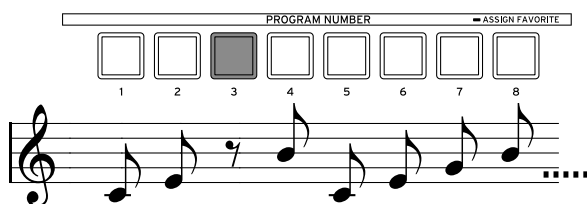
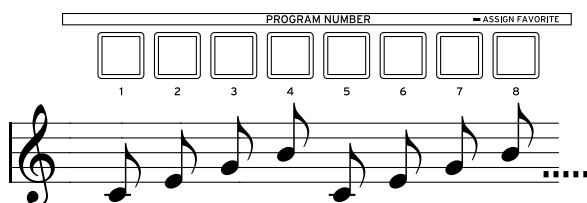

Type: Up Last Step: 8

## Selecting favorites

---

You can register up to eight favorite programs for quick recall. This is useful when you're playing live and in similar situations.

### | Selecting a favorite

- 1** Long-press the BANK button.  
The PROGRAM NUMBER 1-8 buttons blink.  
If you are on the home page, the currently registered favorite programs will be displayed. To view a list of the registered programs and their full names, press the FUNCTION 5 button.  
If you are on one of the edit pages, selecting a favorite by pressing one of the PROGRAM NUMBER 1-8 buttons will return you to the home screen.
- 2** Press the PROGRAM NUMBER 1-8 buttons to select the favorite programs assigned to each.
- 3** To exit favorites mode, press the BANK button or turn the PROGRAM SELECT dial.

### | Registering a favorite program

 Save the programs you've edited to the memory of the microKORG2. Any edits you make are lost if you turn off the microKORG2 or select a different program before saving the data.

- 1** Select a program to register.
- 2** Long-press the PROGRAM NUMBER 1-8 button that you want to register the current program to.  
This registers the program.





## Using the loop recorder

---

This feature lets you record what you play when using the synth programs or the vocal processor, and play it back.

 The recorded audio data is deleted once you turn the power off.

### | Recording to the loop recorder



- 1 Press the LOOP RECORDER  button (the button blinks red).
- 2 Once you press the  button, recording starts after the pre-count.
- 3 Record what you play on the keyboard, or use the vocal processors.  
Recording is done over and over within the loop range, as an overdub.
- 4 Press the  button to exit recording and switch to playback mode.
- 5 Press the  button to stop.

*Tip:* You can also record the input signal from the AUX IN jack. → [Details](#)

*Note:* If the system tempo is changed after recording, the pitch of the recorded audio will also change. Selecting a program with a different tempo setting than the current program will also cause this to occur. If you do not want this to happen, please use the TEMPO LOCK feature.

*Note:* The loop recorder will automatically cancel recording and record standby when a new program is selected.

### Undo/redo

- Press the  button to restore (undo) the recorded audio to how it was before. Press the  button again to return to the existing state (redo).

### | Playing back the loop recorder

- Press the  button to begin playback, and press the button again to stop.



### | Erasing recorded data

Long-press the  (CLEAR) button to delete all of the data you recorded.

*Note:* The delete operation cannot be undone.

*Note:* You can't erase the data while a loop is recording.

### | Editing the settings

- 1 Long-press the LOOP RECORDER  button to access the LOOP SETTING A page, which contains the recording-related settings.  
You can also press the  button to access the LOOP SETTING B page, which contains the playback-related settings.
- 2 Use the EDIT CONTROL 1-5 knobs to set the parameters. → [LOOP SETTING A](#), → [LOOP SETTING B](#)
- 3 Press the HOME (FUNCTION 5) button to exit the settings.

*Note:* These settings are saved automatically.

# Editing

---

- [How the microKORG2 is structured](#)
- [Editing a synth program](#)
- [Performance Edit controls](#)
- [Writing a program](#)
- [Saving other data](#)

# How the microKORG2 is structured

## microKORG2 Block Diagram

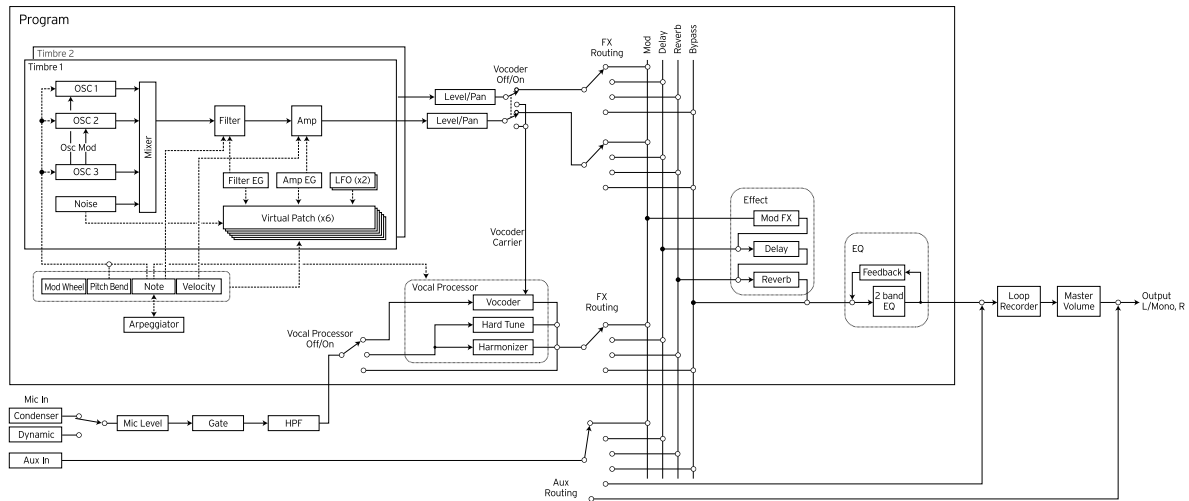

## Oscillator, filter, amp

All sounds have three basic attributes; pitch, tone, and volume.

To control these attributes, the microKORG2 analog modeling synthesizer features an oscillator, filter and amp (amplifier) section, just as on the analog synthesizers of the past.

The oscillator settings vary the pitch, the filter settings modify the tone, and the amp settings modify the volume.

On the microKORG2, the OSC1, OSC 2, OSC 3 and PITCH pages control the oscillators. The PITCH page specifies the pitch of the waveform that is the basis of the sound, and the OSC 1, OSC 2 and OSC 3 pages are for selecting the waveforms. The waveforms generated in this oscillator section are mixed in the MIXER page.

The FILTER page contains the filter-related settings for adjusting the sound.

The TIMBRE MIX contains the amp-related settings, for modifying the volume and outputting the final sound.

These sections determine the basic sound of the program.

## EG, LFO, keyboard tracking, virtual patch, controllers

Aside from the sections described above, the microKORG2 offers ways for varying the sound according to time, key range, performance expression and so forth.

These sections are controlled by modulators and controllers such as the EG (envelope generator), LFO (low frequency oscillator), keyboard tracking, PATCH (virtual patch) and the PITCH and MOD wheels. You can use these modulators and controllers to change the basic sound of the program.

See "Timbre 1" in the microKORG2 structural diagram. The diagram shows how the signal flows in this order: OSC → FILTER → AMP. It also shows how the modulators such as EG and LFO can affect these blocks.

The diagram also shows the sections of the microKORG2, including TIMBRE 1/2, VOCAL PROCESSOR, the effects (MOD, DELAY and REVERB), EQ, arpeggiator and loop recorder.

## | TIMBRE 1/2

Each timbre consists of the OSC, FILTER, AMP, EG, LFO and virtual patch blocks, among others. As the microKORG2 has two timbres, you can combine them to create more complex programs.

## | Effects (EFFECT) and equalizer (EQ)

The output of timbres 1/2 is routed to the effects as follows: modulation effect (MOD) → delay effect (DELAY) → reverb effect (REVERB) → equalizer (EQ).

For the modulation effect, you can choose from nine effects including chorus, six types of delay and six types of reverb. The EQ is a two-band equalizer.

## | ARPEGGIATOR

You can apply the arpeggiator's performance to a timbre. If the program uses two timbres, you can apply the arpeggiator performance to either or both timbres.

This is a step arpeggiator with ten kinds of arpeggios.

## | Vocal processors (VOCAL PROCESSOR)

A vocoder, hard tune and harmonizer are available as vocal processors.

### Vocoder

A vocoder analyzes the character (the frequency characteristics of each band) of a "modulator" signal (typically a human voice from a mic), and applies a filter that uses the analyzed characteristics to the "carrier" signal (a waveform produced by an oscillator or other source), giving a vocal character to the sound (making it seem as though the instrument is talking, for example).

The microKORG2 has a built-in 16-channel vocoder. In addition to simulating the classic vocoder sounds of the past, you can use this vocoder to modify the character of the sound, or edit the level of each frequency band to create truly original vocoder sounds.

**Carrier:** The carrier signal that's processed by the vocoder effect is the input sound from timbres 1 and 2 of the microKORG2. Suitable choices for the carrier waveform are sawtooth waves and so forth, which contain a rich array of overtones. The volume of each signal source is adjusted using the MIXER, and the signal is output to the vocoder section.

**Modulator:** The modulator is the signal that's input to the MIC IN CONDENSER or DYNAMIC jack.

**Vocoder section:** These are the parameters related to the 16 bandpass filters on the carrier side and the envelope follower on the modulator side, and are frequently used when shaping the character of the vocoder.

The audio signal from the MIC IN jack (modulator) is input to 16 bandpass filters, and the Env Follower detects the volume envelope (time-based change) of each frequency band.

The signal from the internal tone generator (carrier) is then input to the other set of 16 bandpass filters, and processed by the envelopes detected by the ENVELOPE FOLLOWER to modulate the input audio, giving the impression that the instrument or sound is talking.

It is also possible to use the Formant to alter the frequency of each carrier bandpass filter. This causes the frequency characteristic curve to be raised or lowered while preserving the character of the modulator, which dramatically affects the tone.



### **Hard tune**

Use this to create robot-like voices by adjusting the vocal pitch, or to adjust the formant for a thicker, lower vocal sound or a thinner, higher sound.

### **Harmonizer**

Adds harmonies (chord tones) to the vocal by shifting the original pitch of the vocal and outputting the result.

# Editing a synth program

## Basic editing

There are two ways to edit sounds on the microKORG2.

- You can select a program that's close to the sound you want, and create the desired program by making the necessary changes.
- Making a program from the default settings

The main steps are shown below.

- 1 Select the program that you want to edit. → [Details](#)  
To create a program from scratch, initialize the program. → [Details](#)
- 2 Press the button corresponding to the parameters you want to edit from one of the following sections: TIMBRE, TIMBRE EDIT, EDIT, VOCAL PROCESSOR, EFFECT, and EQ (the buttons blink). If there are multiple pages, pressing the button multiple times will cycle through the pages.

*Tip:* Consider how the sound you have in mind differs from the original program, and then choose the appropriate parameters to edit.

*Tip:* If you're creating a sound from scratch (the default settings), you can move through the sections by pressing the buttons as they are laid out on the panel, as they are organized in the order you would use for creating sounds.

- 3 Turn the EDIT CONTROL knobs 1 through 5 to edit the values of their assigned parameters. For instance, if you select FILTER in step 2, the parameters for each knob are shown in the display.



Use knob 2 to change the cutoff frequency value, which changes the tone. Use knob 3 to change the resonance value, adding a distinctive character to the sound. → [FILTER](#)

You can also try changing parameters like Attack and Decay in the AMP EG section → [AMP EG](#), Portamento Time (PortaTime) in the PITCH section → [PITCH](#), or the MOD, DELAY and REVERB parameter values → [EFFECT, EQ section](#), and check out the results.

- 4 To fine-tune the values, turn the knob in question (or if you don't want to change the value, turn the knob while holding down the FUNCTION 5 button) and press the INC (FUNCTION 2) or DEC (FUNCTION 1) buttons. This changes the value in by one step.
- 5 Repeat steps 2-4 as necessary to finish making your sound.
- 6 Write (save) the program. → [Writing a program](#)

**⚠** If you select a different program or turn off the microKORG2 before writing the program, all changes that you made are lost.

*Tip:* You can copy the settings for other timbres or from a section you choose. → [Copying programs and timbres \(COPY\)](#)

## Restoring a parameter to its original value

You can check the original values of the preset programs and saved programs by looking at the colors in the center of the display knobs.

If a knob is filled in with its own color, this shows that the knob's value has been changed. If the knob is filled in with a slightly lighter color, its value is equal to the saved value.

*Tip:* You can change how the knobs behave when the internal value doesn't match the position of the knob with the "Knob Mode" parameter on the EDIT CONTROL page. → [Details](#)

## | Selecting a timbre

Each program can use two timbres.

Each timbre consists of the TIMBRE EDIT VOICE through PATCH 1-6 sections.

### Using two timbres (dual)

- 1 Set Timbre Mode (Timb Mode) on the VOICE page to "Dual".
- 2 Press the TIMBRE button to select the timbre to edit (the LED lights up).
- 3 Long-press the TIMBRE button to adjust the levels and panpots for the timbres 1 and 2.

## Performance Edit controls

This shows how to assign parameters to the Performance Edit controls.

- 1 Select a program.
- 2 Press the TIMBRE EDIT VOICE button to select the ASSIGN page.



- 3 Use the EDIT CONTROL 1-5 knobs to assign the parameters.  
For a list of the parameters, see the "Performance Edit List". Refer to "ASSIGN" for an explanation of each parameter.
- 4 You can save the settings for each program.  
Refer to "Writing a program" for details on how to save.

## Writing data (saving)

---

 Save the programs you've edited to the memory of the microKORG2. Any edits you make are lost if you turn off the microKORG2 or select a different program before saving the data.

If the battery charge on the microKORG2 is low, you may not be able to save the data. In this case, connect the AC adapter or replace the batteries, make the settings again and save them.

Never turn off the power while data is being written. This could result in data corruption.

# Writing a program

## Settings that are saved

- All parameters for TIMBRE MIX, TIMBRE EDIT and EDIT ARP A, B
- All parameters for VOCAL PROCESSOR, EFFECT and EQ
- ARPEGGIATOR ON/OFF, TEMPO
- VOCAL PROCESSOR (SETTING), EFFECT (ROUTING), EQ ON/OFF
- OCTAVE SHIFT UP, DOWN

**1** Press the WRITE (FUNCTION 4) button.

The FUNCTION 4 button LED blinks, and the BANK and PROGRAM NUMBER LEDs blink.

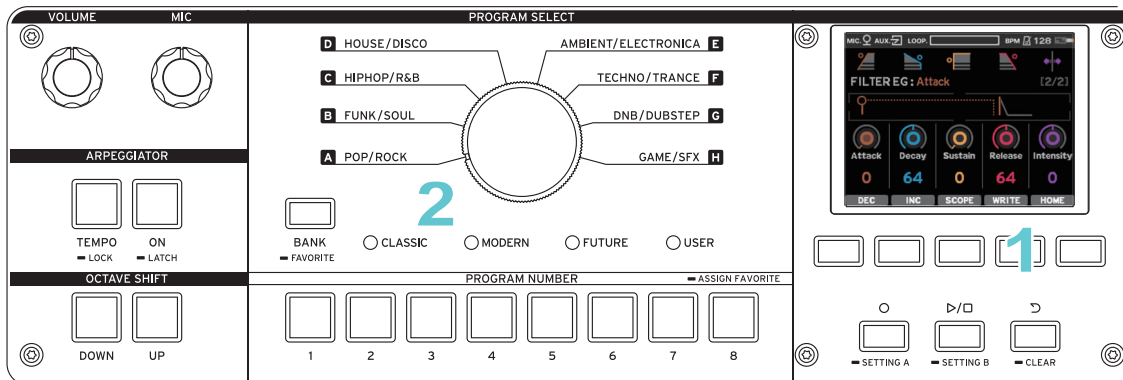

**2** Use the PROGRAM SELECT dial, the BANK button and the PROGRAM NUMBER buttons 1-8 to select the save destination program number.

Press the CANCEL (FUNCTION 5) button to cancel.

*Tip:* The USER bank contains initialized programs by factory default. Select a save destination if you don't want to overwrite the existing program.

**3** Name the program. Move the cursor using the CUR < (FUNCTION 1) and CUR > (FUNCTION 2) buttons, use the EDIT CONTROL 1-4 knobs to select the character, and use knob 5 to select the background color.

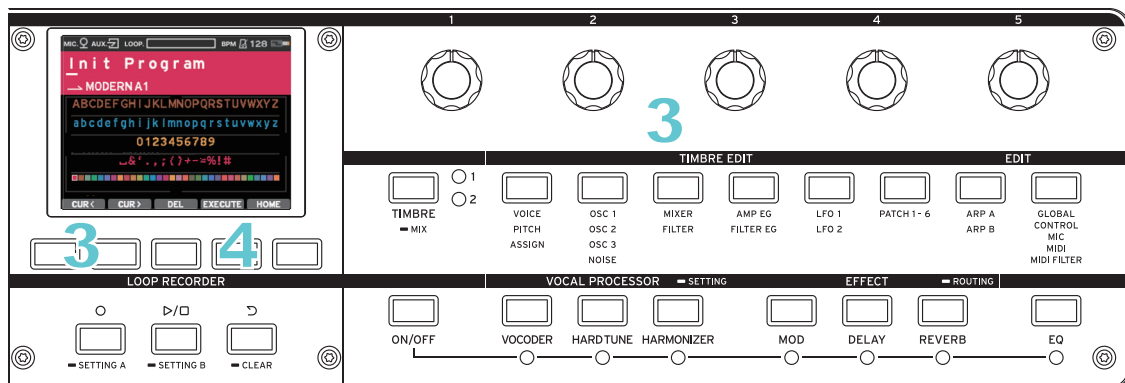

**4** Press the EXECUTE (FUNCTION 4) button to save the data.

Press the CANCEL (FUNCTION 5) button if you wish to cancel.

After the data is saved, the microKORG2 returns to its normal operating state.

## Saving other data

---

### | Saving the GLOBAL-MIDI FILTER and LOOP SETTING settings

The GLOBAL, CONTROL, MIC, MIDI, MIDI FILTER and LOOP SETTING A, B settings are saved when you exit each page.

### | Other settings

The TROPHY (results) data is saved when the power is turned off.

The loop recorder audio data is not saved, and is deleted once you turn the power off.

## TIMBRE section

---

→ [TIMBRE](#)



# TIMBRE

## TIMBRE

Select either timbre 1 or 2 to edit.

- Press the TIMBRE button to switch between timbres (either LED 1 or LED 2 lights up).

*Note:* Switching between timbres is available when Timbre Mode in VOICE is “Dual”. You can’t switch between timbres in Single mode.

## TIMBRE MIX

This adjusts the volume and panpot of the two timbres.

- Long-press the TIMBRE button to show these settings (the button blinks).



**Timbre1 Level (Timb1 Lvl) [0...127]**

Adjusts the volume of timbre 1.

**Timbre1 Pan (Timb1 Pan) [L63...L1, Center, R1...R63]**

Adjusts the panpot of timbre 1.

**Timbre2 Level (Timb2 Lvl) [0...127]**

Adjusts the volume of timbre 2.

*Note:* This is enabled when Timbre Mode is set to “Dual”.

**Timbre2 Pan (Timb2 Pan) [L63...L1, Center, R1...R63]**

Adjusts the panpot of timbre 2.

*Note:* This is enabled when Timbre Mode is set to “Dual”.

## TIMBRE EDIT section

---

- [VOICE, PITCH, ASSIGN](#)
- [OSC 1, OSC 2, OSC 3, NOISE](#)
- [MIXER, FILTER](#)
- [AMP EG, FILTER EG](#)
- [LFO 1, 2](#)
- [PATCH 1-6](#)

# VOICE, PITCH, ASSIGN

## VOICE

These settings are related to the programs overall as well as how the timbres sound.

This sets whether one timbre (Single) or two timbres (Dual) are used.

You can also set how the notes are triggered here, such as single notes/chords, unison and so forth.



### 1. Timbre Mode (Timb Mode) [Single, Dual]

Sets how many timbres the program will use.

**Single:** Only one timbre is used.

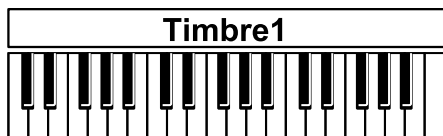

**Dual:** Two timbres are used. When you play the keyboard, both timbres play simultaneously. You can edit the two timbres individually.

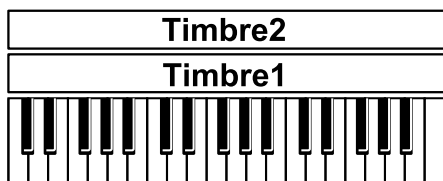

The maximum polyphony is eight voices (eight notes). In Dual mode, the maximum polyphony is four voices (since timbres 1 and 2 are played together).

### 2. Poly / Mono [Poly, Mono Legato, Mono Retrigger]

Specifies how the timbres are triggered.

When this is set to monophonic mode, you can specify whether the EG and LFO are retriggered when you play the next key while still holding down the previous key.

**Poly:** The program plays polyphonically, letting you play chords. The maximum polyphony is eight voices.

*Note:* This may vary depending on the settings.

**Mono Legato:** The sound plays monophonically (one note at a time). Only one sound for the timbre can be played at a time. The EG and LFO will only reset for the first note played. Use this setting if you want to play legato.

**Mono Retrigger:** The sound plays monophonically. Only one sound for the timbre can be played at a time. The EG and LFO are retriggered each time you press a key.

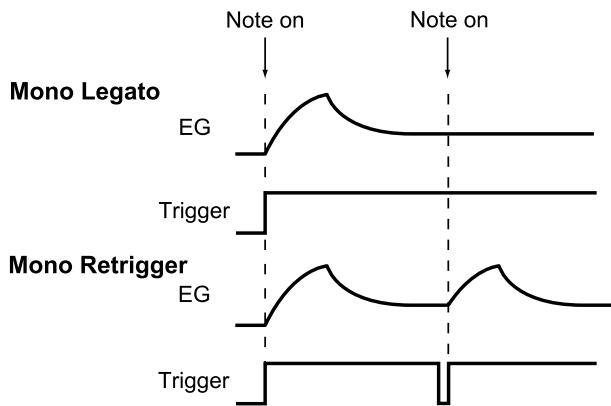

**3. Unison Number (Unison) [Off, 2 Voice...8 Voice]**

Specifies the number of voices that will sound for each note you play. When this is off, voices will not sound in unison, and "Unison Detune" and "Unison Spread" cannot be applied. You can make up to eight voices play in unison.

*Note:* The maximum value is 8 when Timbre Mode is "Single", and the maximum value is 4 when Timbre Mode is "Dual".

**4. Unison Detune (U.Detune) [0...127] (CC#33)**

Specifies how much the individual notes that sound at the same time are detuned when played in unison.

The number of voices set in Unison Number are uniformly assigned to play at the same time, detuned by the amount you set here.

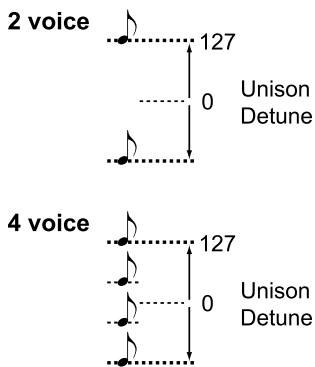

**5. Unison Spread (U.Spread) [0...127] (CC#34)**

Widens the panpot (stereo position) settings for the individual notes that sound at the same time when played in unison.

## PITCH

This sets the pitch of the oscillators. Set the Transpose and Fine Tune to produce the desired pitch. These settings are shared by all three oscillators. You can also set the portamento time and the amount of pitch change that's caused by the [PITCH] wheel.

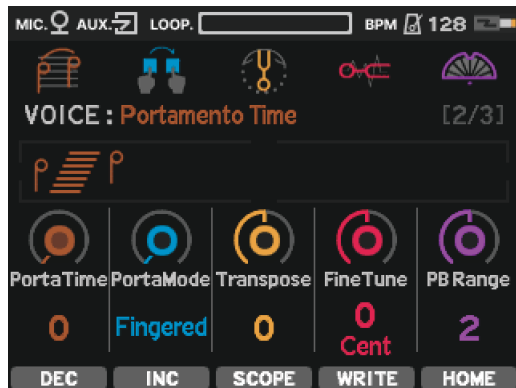

### 1. Portamento Time (PortaTime) [0...127] (CC#5)

Adjusts the speed of the portamento effect. Portamento is a smooth change in pitch from one note to another.

With a setting of 0, the portamento effect is not applied. Larger values cause the pitch to change over a longer time.

### 2. Portamento Mode (PortaMode) [Fingered, Always] (CC#65)

Sets how the portamento effect is applied when you press a key.

**Fingered:** The portamento effect is only be applied to notes played while a key is being held.

**Always:** The portamento effect is always applied to the notes you play, regardless of whether you hold down the previous notes.

### 3. Transpose [-24...0...24] (CC#35)

Adjusts the pitch of the oscillator in half tones (100-cent) steps. The range is two octaves upward or downward.

### 4. Fine Tune [-50...0...+50 Cent] (CC#36)

Sets the pitch of the oscillator in one-cent steps. The range is 50 cents upward or downward ( $\pm 50$  cents).

### 5. Pitch Bend Range (PB Range) [-24...0...24]

Specifies the amount of pitch change in semitones that occurs when you use the pitch bend.

## ASSIGN

You can assign parameters to the five EDIT CONTROL knobs, to control for Performance Edit.

*Tip:* When the home page is selected using the FUNCTION 5 button in Performance Edit, operate the five EDIT CONTROLS knobs to alter the sound and so forth.



- |                  |  |
|------------------|--|
| <b>1. Knob 1</b> | <b>[NoAssign, TIMBRE1 Unison Detune, ..., Loop Rec Stutter Offset]</b> |
| <b>2. Knob 2</b> | <b>[NoAssign, TIMBRE1 Unison Detune, ..., Loop Rec Stutter Offset]</b> |
| <b>3. Knob 3</b> | <b>[NoAssign, TIMBRE1 Unison Detune, ..., Loop Rec Stutter Offset]</b> |
| <b>4. Knob 4</b> | <b>[NoAssign, TIMBRE1 Unison Detune, ..., Loop Rec Stutter Offset]</b> |
| <b>5. Knob 5</b> | <b>[NoAssign, TIMBRE1 Unison Detune, ..., Loop Rec Stutter Offset]</b> |

Assigns the parameters that are controlled with the respective EDIT CONTROL knobs. See "Performance Edit List" for a list of parameters that you can set.

# OSC 1, OSC 2, OSC 3, NOISE

The oscillator generates the audio waveforms, which are the basis of the sound.

A timbre consists of three oscillators and a noise generator.

You can create a variety of sounds by combining multiple oscillators.

For example, you can adjust the Semitone and Fine Tune values so that one oscillator acts as the overtone for the other oscillators, or set the pitches of the oscillators to a harmony, or set multiple oscillators to the same pitch but slightly detune one of them to create a detuning effect.

You can also use ring modulation, oscillator sync and so on to create very complex overtone structures. Set the type using the OSC Mod Type parameter for oscillator 3, and set how these effects are applied with OSC Mod Amount for oscillators 1 and 2.

## | OSC 1

Here are the settings for oscillator 1 (OSC 1).



### 1. Wave [Saw, Square, Triangle, Sine, DWGS, OneShot] (CC#8)

Selects the waveform for oscillator 1.

The parameters you can adjust depend on the waveform you select here.

**Saw:** This generates a sawtooth wave, which is used for creating a wide range of uniquely analog synthesizer sounds such as bass sounds, pads and so forth.

**Square:** Generates a square wave, which is suitable for electronic sounds or simulating wind instruments. You can create clavinet or sax-like sounds by adjusting the pulse width.

**Triangle:** Triangle waves have fewer harmonics than sawtooth or square waves, and are suitable for rounder sounds like basses or pads.

**Sine:** Sine waves are fundamental waves with a rounder sound that do not have harmonics.

**DWGS (Digital Waveform Generator System):** These are waveforms created using an additive harmonic method. Choose this when you want to create sounds with a distinctive "digital synth" character, such as synth bass, electric piano, bells or voice-like sounds. 64 waveforms are available.

**OneShot:** These are PCM waves that do not sustain, such as percussion, metallic sounds, click noises and so on. Select this when you want to create sound effects, or sounds that add a certain character to the beginning of other oscillator sounds. You can choose from 32 PCM waves.

**2. Shape/Sample** ["Mode" Saw-Sine: 0...127/"Mode" DWGS: 1...64, "Mode" OneShot: 1...32] (CC#9)

If you're using the Saw through Sine waveforms, set the Shape here.

If you're using the DWGS or OneShot waveform, set the Sample.

**When Wave is "Saw":** You can modify the waveform by adjusting this value. A setting of 0 produces a sawtooth wave, and a setting of 127 produces a sawtooth wave one octave higher.

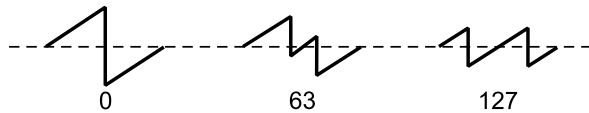

**When Wave is "Square":** This value sets the pulse width. A setting of 0 produces a pulse width of 50% (square wave), and a setting of 127 produces a pulse width of 0% (no sound). The sound becomes "harder" as the value approaches 0%.

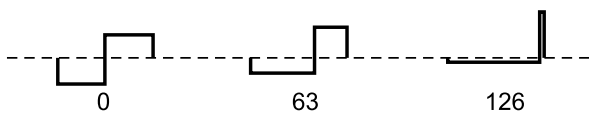

**When Wave is "Triangle":** You can modify the waveform by adjusting this value. A setting of 0 produces a basic triangle wave, and a setting of 127 produces a waveform with a pitch that is one octave and a fifth higher.

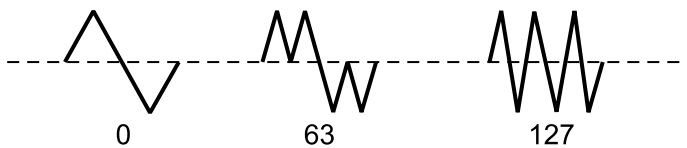

**When Wave is "Sine":** A value of 0 produces a pure sine wave, and a setting of 127 produces a slightly distorted "fat" sine.

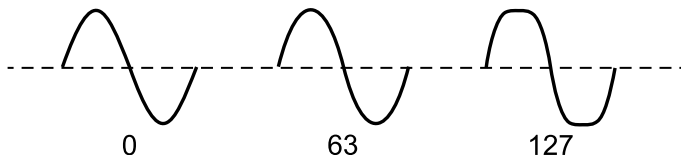

**When Wave is "DWGS":** Changing the value selects a sampled waveform.

→ [DWGS](#)

**When Wave is "OneShot":** Changing the value selects a sampled waveform.

→ [Oneshot](#)

**3. OSC Mod Amount (OSC Mod)** [Off, 1...127] (CC#15)

Sets how much modulation from oscillator 3 is applied to the sound of oscillator 1.

**4. Semitones** [-24...0...24] (CC#16)

Adjusts the pitch of oscillator 1 in semitones (100 cent) steps. A value of  $\pm 12$  produces a difference of  $\pm 1$  octave, and a value of  $\pm 24$  produces a difference of  $\pm 2$  octaves.

**5. Fine Tune** [-50...0...+50 Cent] (CC#17)

Sets the pitch of the oscillator in one-cent steps. The range is  $\pm 50$  cents.



## | OSC 2

Here are the settings for oscillator 2 (OSC 2). These are the same as for oscillator 1 (OSC 1). → [OSC 1](#)

1. **Wave** [Saw, Square, Triangle, Sine, DWGS, OneShot] (CC#18)
2. **Shape/Sample** [SAW-Sine: 0...127/DWGS: 1...64, OneShot: 1...32] (CC#19)
3. **OSC Mod Amount (OSC Mod)** [Off, 1...127] (CC#20)
4. **Semitones** [-24...0...24] (CC#21)
5. **Fine Tune** [-50...0...+50 Cent] (CC#22)

## OSC 3

Here are the settings for oscillator 3 (OSC 3).

When applying oscillator modulation, oscillator 3 modulates oscillators 1 and 2, and oscillators 1 and 2 output the modulated result.



**1. Wave** [Saw, Square, Triangle, Sine, DWGS, OneShot] (CC#48)

**2. Shape/Sample** [SAW-Sine: 0...127/DWGS: 1...64, OneShot: 1...32] (CC#49)

These are the same as for oscillator 1 (OSC 1). → [OSC 1](#)

**3. OSC Mod Type (ModType)** [Disable, Ring, Sync, Ring&Sync, VPM]

Selects the type of oscillator modulation that's produced in conjunction with oscillators 1 and 2.

**Disable:** No modulation is applied to the output sound.

**Ring:** This modulation generates the frequency sum and difference with the other two oscillator waveforms. Adjust the Semitones and Fine Tune to create metallic, atonal sounds. This is useful for sound effects.

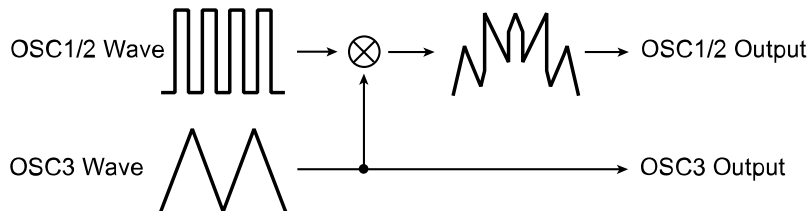

**Sync:** This modulation forcibly synchronizes the phase of oscillators 1 and 2 to the phase of oscillator 3. This is effective for synth leads. Adjust the harmonics using the Semitones and Fine Tune values. The pitch of the fundamental does not change.

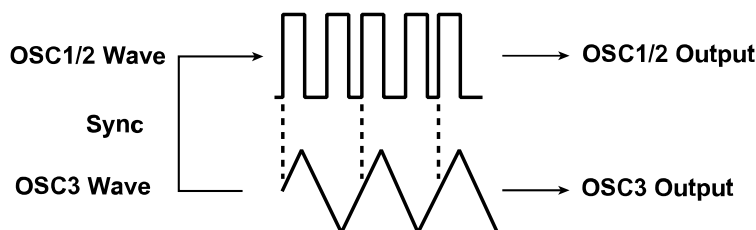

**Ring&Sync:** This simultaneously applies ring and sync modulation.

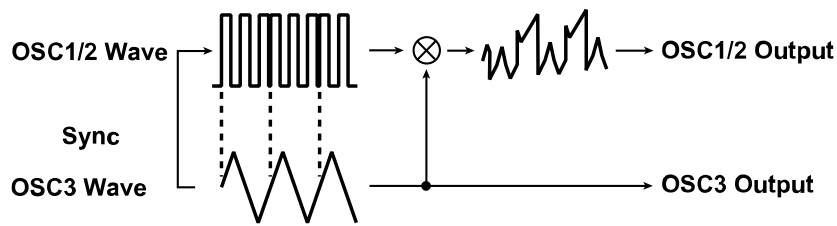

**VPM:** VPM (variable phase modulation) lets you use oscillator 3 to modulate the phase of oscillators 1 and 2, creating metallic overtones.

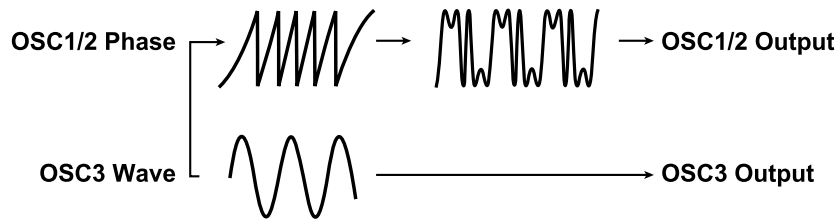

**4. Semitones** [-24...0...24] (CC#51)

Sets the pitch of oscillator 3 in half tone (100 cent) steps. A value of  $\pm 12$  produces a difference of  $\pm 1$  octave, and a value of  $\pm 24$  produces a difference of  $\pm 2$  octaves.

**5. Fine Tune (FineTune)** [-50...0...+50 Cent] (CC#52)

Sets the pitch of oscillator 3 in one-cent steps. The range is  $\pm 50$  cents.

## NOISE

Use these parameters to configure the noise and the keyboard tracking (how the sound “follows” or changes according to the note you play) for the pitches of oscillators 1, 2 and 3.

Noise is used to create percussion instrument sounds, or sound effects such as surf. You can process the noise sound by selecting and configuring the dedicated filter or decimator used for the noise generator.



### 1. Noise Type [LPF, HPF, BPF, Deci] (CC#29)

Selects the dedicated filter or the decimator used for the noise generator.

**LPF:** Low-pass filter.

**HPF:** High-pass filter.

**BPF:** Bandpass filter.

**Deci:** Decimator.

### 2. Noise Color [0...127] (CC#30)

Changes the sound of the noise generator.

When “**LPF**” is set for Noise Type: Adjusts the cutoff frequency of the low-pass filter.

When “**HPF**” is set for Noise Type: Adjusts the cutoff frequency of the high-pass filter.

When “**BPF**” is set for Noise Type: Adjusts the frequency band of the peak characteristics.

When “**Deci**” is set for Noise Type: Adjusts the sample rate.

*Tip:* The noise generator differs from the oscillators in that the sound is the same no matter what note you play. However, you can make the pitch of the noise change according to the note you play, by setting “Noise Color” for the virtual patch Destination (Dest), and by setting KbdTrk to either “Source 1” or “Source 2”.

### 3. OSC 1 Keytrack (OSC1 KBD) [Ratio, Fixed]

This sets the keyboard tracking (how the sound “follows” or changes according to the note you play) for the pitches of each oscillator.

**Ratio:** The oscillator pitch changes according to the note you play, as with a typical keyboard instrument.

**Fixed:** The same pitch is produced no matter which note you play.

### 4. OSC 2 Keytrack (OSC2 KBD) [Ratio, Fixed]

### 5. OSC 3 Keytrack (OSC3 KBD) [Ratio, Fixed]

OSC 2 Keytrack and OSC 3 Keytrack are the same as OSC 1 Keytrack.

# MIXER, FILTER

## MIXER

This adjusts the volume balance between oscillators 1-3 and the noise generator.

These settings are the input levels to the filter.



**1. OSC 1 Level (OSC1 Lvl) [0...127] (CC#23)**

Sets the output level of oscillator 1.

**2. OSC 2 Level (OSC2 Lvl) [0...127] (CC#24)**

Sets the output level of oscillator 2.

**3. OSC 3 Level (OSC3 Lvl) [0...127] (CC#25)**

Sets the output level of oscillator 3.

**4. Noise Level (Noise Lvl) [0...127] (CC#26)**

Sets the output level of the noise generator.

## FILTER

The filter removes unnecessary frequency components from the sound of the oscillator. This shapes the tone by allowing only the desired portion of the sound to pass.

The Type parameter fades between the different filter types (i.e., the method used by the filter to cut the frequencies). The Cutoff parameter sets the frequency at which the cut will occur. Normally, turning the knob clockwise brightens the sound, and turning it counterclockwise darkens the sound. The Resonance parameter emphasizes the frequency region near the cutoff frequency, adding a distinctive character to the sound.



### 1. Type [LP4 (0), ..., LP2 (32), ..., BP2 (64), ..., HP2 (96), ..., HP4 (127)] (CC#27)

This fades between the different filter types. The values between types determine the mix of those types relative to one another.

**LP4 (0):** A -24 dB LPF (-24 dB/oct low pass filter). The -24 dB LPF is a common type of filter that lets the frequencies below the cutoff frequency pass through, and cuts the frequencies that are above. Lowering the cutoff frequency makes the tone darker and more mellow.

**LP2 (32):** A -12 dB LPF (-12 dB/oct low pass filter). The -12 dB LPF has a more gentle slope than the -24 dB LPF, producing a more natural-sounding effect.

LPF (Low Pass Filter)

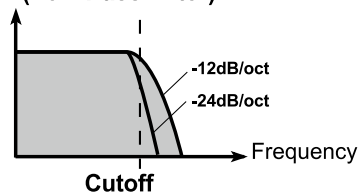

**BP2 (64):** A -12 dB/oct BPF (band pass filter). The -12 dB BPF allows frequencies within the band around the cutoff frequency to pass, and cuts the remaining frequencies. Use this when you wish to emphasize only a specific portion of the frequency range. For example, you can use this to create sounds that use only certain frequency bands, like voices heard over the radio or the telephone.

BPF (Band Pass Filter)

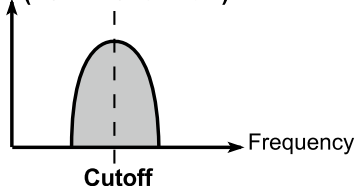

**HP2 (96):** A -12 dB/oct HPF (high pass filter). The -12 dB/oct HPF is a filter that lets the frequencies higher than the cutoff frequency pass through, and cuts the frequencies that are lower. Use this when you wish to make the sound thinner. Note that if you raise the cutoff frequency too much, the volume decreases significantly.

**HP4 (127):** A -24 dB/oct HPF (high pass filter). The -24 dB/oct HPF is a steeper filter than the -12 dB/oct HPF.

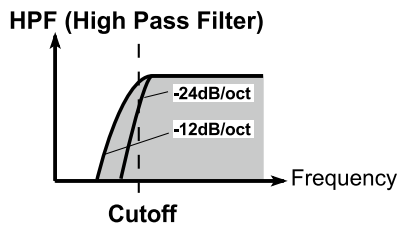

**2. Cutoff [0...127] (CC#74)**

Sets the cutoff frequency. Increase this value to raise the cutoff frequency.

*Tip:* The Cutoff value varies the sound by time-variant change produced by the filter EG, by the dynamics of your keyboard playing (velocity) and by the note you play (keyboard tracking).

*Note:* Some cutoff settings may make the volume significantly quieter.

**3. Resonance [0...127] (CC#71)**

Sets the resonance of the filter. This emphasizes the overtones near the cutoff frequency specified by the Cutoff parameter, adding a distinctive character to the sound. Increasing this value emphasizes the effect.

*Tip:* Since the overtones that are emphasized by the resonance change when you move the Cutoff knob, it's best to adjust both the Cutoff and Resonance knobs.

The effect of resonance

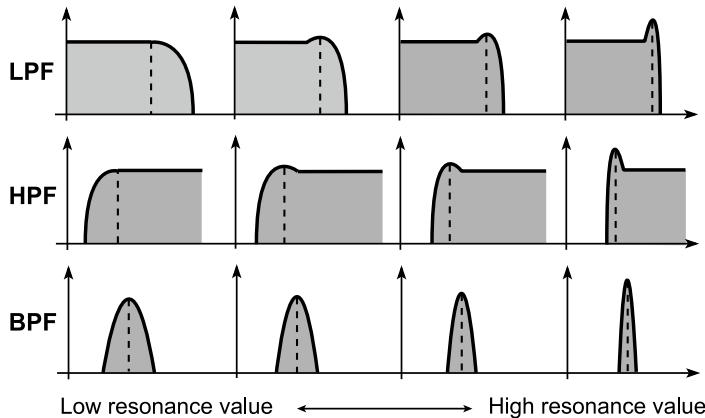

**4. Drive [0...127] (CC#83)**

Sets the drive circuit distortion effect.

**5. Keytrack [-200.0...0.0...200.0%] (CC#28)**

This specifies how keyboard tracking (the note you play on the keyboard) affects the cutoff frequency.

For example, if the sound you hear when playing the C4 key has the desired tone but higher notes don't have enough resonance or are too mellow-sounding, you can adjust the keyboard tracking to compensate so that the cutoff frequency rises as you go up the keyboard.

With a positive (+) setting, the cutoff frequency rises as you go up the keyboard from C4, and falls as you go down the keyboard. With a negative (-) setting, the cutoff frequency falls as you go up the keyboard from C4, and rises as you go down the keyboard. With a setting of +100.0 %, the change in cutoff frequency is proportionate to the change in pitch. With a setting of 0, keyboard tracking does not affect the cutoff frequency.

# AMP EG, FILTER EG

## AMP EG

Here you can configure the AMP EG, which applies time-variant change to the volume.

Create the desired volume curve by adjusting the ADSR parameters: Attack [1], Decay [2], Sustain [3] and Release [4].



### 1. Attack [0...127] (CC#73)

Sets the time from note-on (when the key is pressed) until the attack level (maximum value of the envelope) is reached.

### 2. Decay [0...127] (CC#75)

Sets the time from when the attack level is reached until the sustain level (SUSTAIN) is reached.

### 3. Sustain [0...127] (CC#70)

Sets the volume that's maintained after the decay time has elapsed, as long as you continue holding the key.

### 4. Release [0...127] (CC#72)

Sets the time it takes from note-off (when the key is released) until the level reaches 0.

### 5. Velocity Sens (Velocity) [0...127] (CC#79)

Controls the amplitude of the EG according to the velocity at which you play the keys.

Increasing this value makes the amplitude more responsive to the velocity (how hard or soft you play). With a setting of 0, velocity does not affect the amplitude.

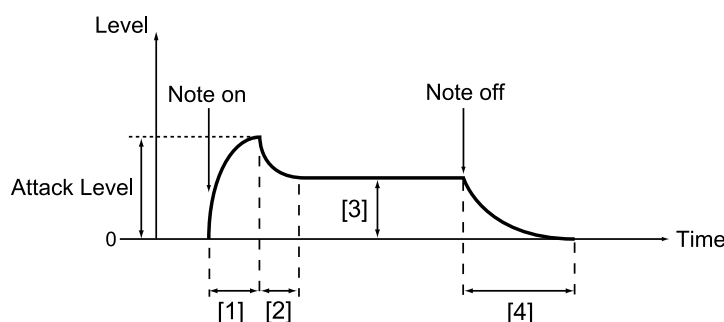

[1]: Attack Time      [3]: Sustain Level  
[2]: Decay Time      [4]: Release Time



## EG (Envelope Generator)

For the most part, each sound changes over time in a distinct way, such as volume. For example, when you play a note on a piano, the note begins at the maximum volume, and gradually diminishes. When you release your finger from the key, the sound disappears quickly with a brief decay. Volume curves such as this are an important aspect of how we identify the sound of a specific instrument. This type of change also occurs in the tone and pitch, as well as in the volume. On a synthesizer, this type of change is produced by an EG. The microKORG2 has dedicated EGs for the filter and for the amp. These EGs can also be used as virtual patch sources, so you are free to use them to vary the pitch or numerous other aspects of the sound.

Some example settings are shown below.

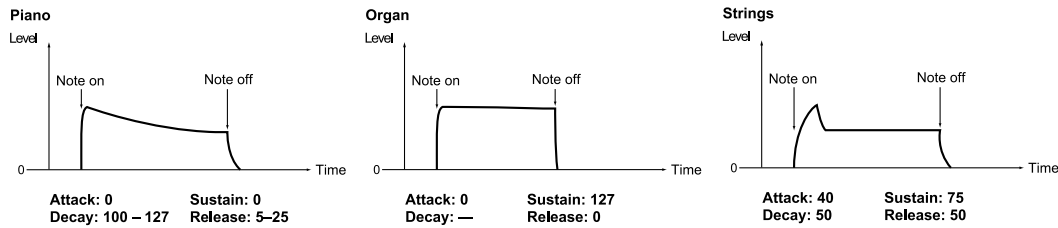

## FILTER EG

Here you can make settings for the filter EG, which applies time-variant change to the tone.

Configure these filter EG settings to make the tonal character of the sound change over time.

The EG Intensity parameter controls how much the filter EG is applied.

Create the desired sound curve by adjusting the ADSR parameters: Attack [1], Decay [2], Sustain [3] and Release [4].

For details on how the EG (envelope generator) works, refer to the previously listed information.



### 1. Attack [0...127] (CC#85)

Sets the time from note-on (when the key is pressed) until the attack level (maximum value of the envelope) is reached.

### 2. Decay [0...127] (CC#86)

Sets the time from when the attack level is reached until the sustain level (SUSTAIN) is reached.

### 3. Sustain [0...127] (CC#87)

Sets the cutoff frequency that's maintained after the decay time has elapsed until you release the key.

### 4. Release [0...127] (CC#88)

Sets the time it takes from note-off (when the key is released) until the level reaches 0.

**5. Intensity** [-63...0...63] (CC#84)

Sets the depth of the modulation that's applied to the cutoff frequency.

This changes the cutoff frequency over time. Positive (+) settings increase the degree of change. Negative (-) settings increase the degree of change in the opposite direction.

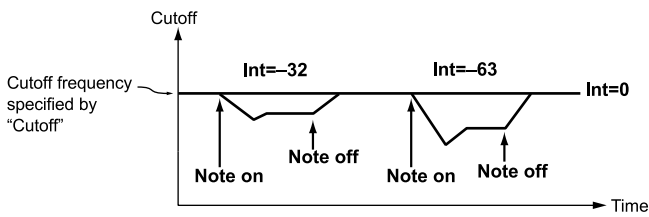
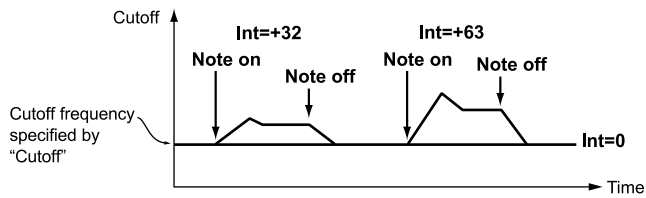
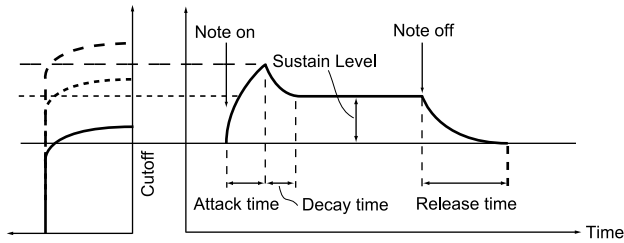
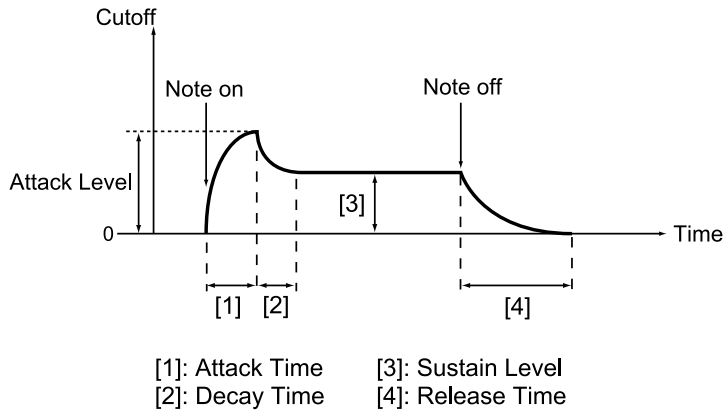

# LFO 1, 2

Each timbre has two LFOs (low-frequency oscillator). The cyclic change produced by an LFO can modulate various aspects of the sound such as the pitch, tone, or volume.

## LFO 1



### 1. Wave [Triangle, Saw Down, Saw Up, Square, Sample & Hold] (CC#89)

Selects the LFO waveform.

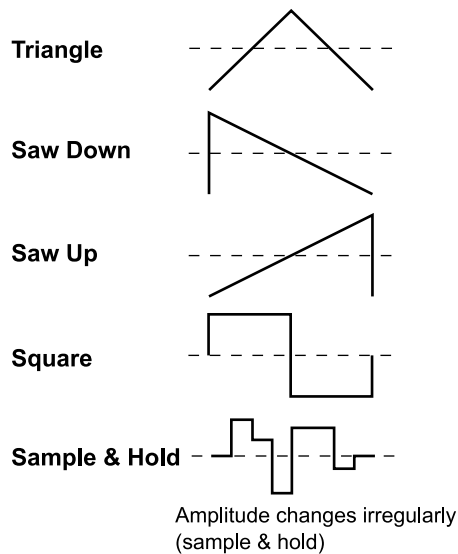

### 2. Mode [Tempo, Free, One Shot]

Specifies whether the LFO cycle is synchronized to the tempo or MIDI clock.

**Tempo:** The LFO cycle is synchronized to the tempo or MIDI clock. When Clock Source on the MIDI page in Global (MIDI clock settings) is set to "Internal", the LFO synchronizes to the tempo that's set by the Tempo parameter. When the value is set to "External MIDI/USB", the LFO synchronizes to MIDI clocks received from an external MIDI device. When the parameter is set to "Auto", the LFO synchronizes to MIDI clocks from an external MIDI device only if they are available.

**Free:** The LFO cycle is not synchronized to the tempo, and instead repeats at the rate set by Frequency.

**One Shot:** The LFO cycle is not synchronized to the tempo, and is instead output for one cycle only at the rate set by Frequency.

**3. Frequency (Freq) ["Mode" Tempo: 1/1, 1/2, 1/3, 1/4, 1/6, 1/8, 1/12, 1/16, 1/24, 1/32 / "Mode" Free, OneShot: 0...127] (CC#90)**

Sets the frequency of the LFO.

When Mode is set to "Tempo": This sets the LFO cycle to a ratio of the tempo. The set value (note length) in relation to the tempo equals one LFO cycle. For instance, a setting of 1/4 makes one beat equal to one cycle.

When Mode is set to "Free" or "One Shot": This sets the LFO frequency. Increasing this value results in a faster frequency.

**4. Key Sync/Key Trigger ["Mode" Tempo, Free: Off, Timbre, Voice/"Mode" OneShot: Timbre, Voice]**

Specifies whether the LFO phase is reset when a note-on occurs for that voice (meaning when you play a key).

**"Key Sync" (when Mode is set to "Tempo" or "Free")**

**Off:** The LFO phase is not reset when a note-on occurs.

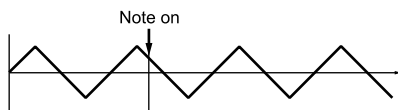

**Timbre:** The LFO phase is reset at the first note-on that occurs while no keys are pressed. The same phase is used for modulating all voices that are triggered by a note-on afterwards.

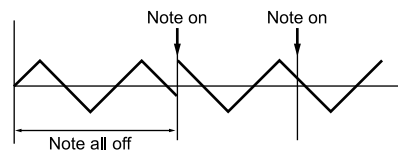

**Voice:** The LFO phase is reset at each note-on, and each voice that plays uses its own LFO phase.

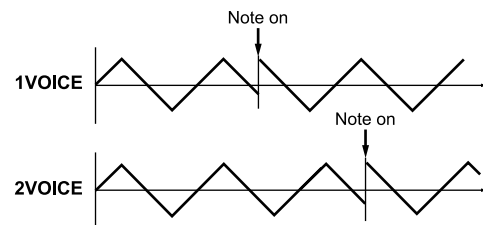

**"KeyTrigger" (when Mode is set to "OneShot") [Timbre, Voice]**

**Timbre:** see "Timbre" in Key Sync.

**Voice:** see "Voice" in Key Sync.

**5. Smooth [0...127] (CC#91)**

Smooths out the motion of the LFO.

## LFO 2



**1. Wave** [Triangle, Saw Down, Saw Up, Square, Sample & Hold] (CC#102)

**2. Mode** [Tempo, Free, One Shot]

**3. Frequency (Freq)** ["Mode" Tempo: 1/1, 1/2, 1/3, 1/4, 1/6, 1/8, 1/12, 1/16, 1/24, 1/32 / Mode "Free", "OneShot": 0...127] (CC#76)

**4. Key Sync/Key Trigger** ["Mode" Tempo, Free: Off, Timbre, Voice/"Mode" OneShot: Timbre, Voice]

The Wave though Key Sync/Key Trigger parameters are the same as for LFO 1.

**5. Delay** [0...127] (CC#92)

Delays the time that it takes for the LFO to take effect once its phase has been reset. No delay is used with a setting of 0.

# PATCH 1-6

## Virtual patch

With analog synthesizers such as modular synths, the inputs and outputs of each module (oscillator, filter, amp, EG, LFO, and other controllers) are connected (“patched”) as desired using patch cords, which gives users a great deal of freedom to create the sound.

The microKORG2 simulates this kind of patching “virtually” (i.e., without using physical patch cords), so you can assign sources such as EG or LFO to the main parameters (destinations).

This instrument has six virtual patch routes that let you create more sophisticated sounds.

Each patch lets you select two modulation sources (using knobs 1 and 2), a parameter to be modulated by the sources called Destination (knob 3), and you can specify the intensity of modulation using the Intensity (knob 4). You can use various patchings to create a wide variety of changes in the sound.

For example, if you set modulation Source 1 to “LFO2” and set modulation Destination to “CutOff”, and adjust the depth of the effect using Intensity, LFO2 creates a cyclic change in tone (a “wah” effect).

## PATCH 1-6



**1. Source 1** [No Assign...Analog] (NRPN 4, 0...5)

**2. Source 2** [No Assign...Analog] (NRPN 4, 16...21)

Selects the modulation source. For example, if you select Filter EG (“Flt EG”), the Filter EG is the modulation source.

You can set up to two modulation sources. The two sources are multiplied to generate a curve, which controls the modulation. Set one of the sources to “NoAssign” if you only want to use a single source.

*Tip:* If you select the same modulation source for Source 1 and 2, this creates an exponential curve for controlling the destination.

**NoAssign:** no source is assigned

**Velocity (+):** Modulation is applied according to the velocity value of 0-127 (velocity means how hard you play the keys).

**Velocity (+-):** Modulation is applied in a negative or positive direction, with the velocity value of 64 as the base.

**KbdTrk (+):** Modulation is applied from note numbers 0 (C-1) through 127 (G8).

**KbdTrk (+-):** Modulation is applied in a negative or positive direction, with note number 60 (C4) as the base.

*Note:* The pitch of keyboard tracking (the note played on the keyboard) is affected by the portamento parameter. The pitch bend wheel, transpose controls, vibrato, and virtual patch connections do not affect key tracking.

**Pitch Bend:** Modulation is applied in a negative or positive direction, with the center position of the PITCH wheel's variable range as the base.

**Mod.W (+):** Modulation is applied according to the value of the MOD wheel (0-127).

**Mod.W (+-):** Modulation is applied in a negative or positive direction, with the center position of the MOD wheel's variable range as the base.

**Flt EG (+):** Modulation is applied only in a positive direction using the filter EG.

**Flt EG (+-):** Modulation is applied in a negative or positive direction using the filter EG.

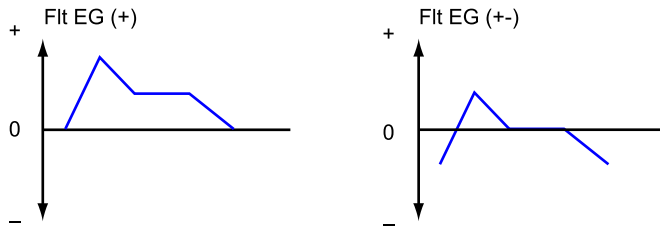

**Amp EG (+):** Modulation is applied only in a positive direction using the amp EG.

**Amp EG (+-):** Modulation is applied in a negative or positive direction using the amp EG.

**LFO1 (+):** Modulation is applied only in a positive direction using LFO 1.

**LFO1 (+-):** Modulation is applied in a negative or positive direction using LFO 1.

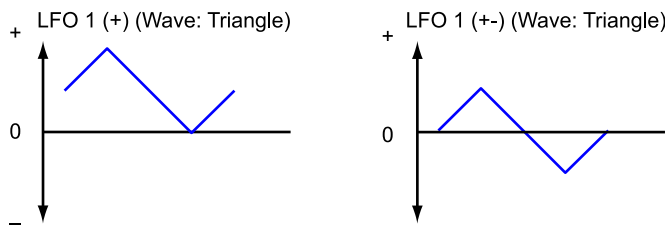

**LFO2 (+), LFO2 (+-):** Same as LFO 1.

**Noise:** Produces continuous change using a random value. This is affected by the Noise Type/Noise Color parameter settings.

**Analog:** Produces a random value each time you play a note, creating analog-like variations.

**3. Destination (Dest) [NoAssign, ..., EQ F.Back] (NRPN 4, 32...37)**

Selects the parameter (destination) to be controlled by the modulation.

For example, if you select TIMBRE Pitch, modulation is applied to the overall pitch of the timbre.

See "PATCH 1-6 List" for a list of parameters that you can set.

**4. Intensity [-63...0...63]**

**(P1: CC#103, P2: CC#104, P3: CC#105, P4: CC#106, P5: CC#107, P6: CC#108)**

Sets the depth of the effect produced by the modulation source. With a setting of 0, no modulation is applied.

**5. Patch Connection (Connect) [Off/On]**

Turns the virtual patch connection on/off.

Virtual patching examples for Source 1/2 and Destination

Source	Destination	Explanation
Velocity	FILTER Cutoff	The cutoff frequency changes according to the velocity (how hard you play the keys).
KbdTrk	TIMBRE Pan	The panpot (stereo position) of the sound gradually changes according to the note you play on the keyboard, with lower notes panned to the left and higher notes panned to the right.
Pitch Bend	TIMBRE Pan	Moving the PITCH wheel or receiving a pitch bend change message causes the sound to pan across the stereo spread.
Mod.W	FILTER Cutoff	The cutoff frequency changes when you operate the MOD wheel or when a CC#1 message is received.
Mod.W	LFO2 Freq	The LFO 2 speed changes when you operate the MOD wheel or when a CC#1 message is received.
Flt EG/Amp EG	TIMBRE Pitch	The Filter EG or Amp EG will vary the pitch of the entire timbre over time.
Flt EG/Amp EG	TIMBRE Pan	The Filter EG or Amp EG changes the panpot setting over time. By using two patches to invert the Intensity value (+/-), you can create more complex panning.
LFO 1/LFO 2	OSC1 Pitch	Vibrato is applied to OSC1 according to the LFO1 or LFO2 frequency.
LFO 1/LFO 2	FILTER Cutoff	Wah is applied according to the LFO1 or LFO2 frequency.
LFO 1/LFO 2	TIMBRE Level	Tremolo is applied according to the LFO1 or LFO2 frequency.
LFO 1/LFO 2	TIMBRE Pan	Auto panpot is applied according to the LFO1 or LFO2 frequency.
Analog	TIMBRE Pitch	The pitch changes randomly for each note that you play. A low Intensity value gives the pitch a loose analog synth feel, and a high Intensity value produces a more random effect.



## EDIT section

---

- [Arpeggiator](#)
- [ARP A, B](#)
- [GLOBAL](#)
- [CONTROL](#)
- [MIC](#)
- [MIDI](#)
- [MIDI FILTER](#)

# Arpeggiator

---

## About the arpeggiator

The microKORG2's arpeggiator features 10 arpeggio types.

You can change the note duration (gate time), intervals of the notes played by the arpeggiator and so forth.

These settings are found in the ARP A and ARP B sections.

Each of the up to eight steps produced by the ARP A and ARP B settings can be switched on/off using the "step arpeggiator," for even more performance possibilities.

## Selecting the timbres to be played by the arpeggiator

For programs that use two timbres (when Timbre Mode is set to "Dual"), you can select the timbres that are triggered by the arpeggiator. This setting is in Target Timbre, ARP A section. You can arpeggiate both timbres, or only timbre 1 or 2.

## Synchronizing the rate of LFO 1/2 or the delay time of the delay effect to the arpeggiator tempo

By synchronizing the LFO 1/2 rate to the tempo of the arpeggio, you can apply modulation that is synchronized to the tempo. You can also specify the time parameter of the delay effect to be a ratio of the tempo, so that the delay time follows the arpeggio even if you change the tempo of the arpeggio. This is particularly useful when playing live.

Since the microKORG2's arpeggiator can be synchronized to an external MIDI sequencer, you can control the LFO 1/2 rate or the delay time from an external MIDI sequencer or other source.

How to use the step arpeggiator → [Details](#)

## | ON

Press the ARPEGGIATOR ON button to switch the arpeggiator on/off (the button lights up when the arpeggiator is on).

Long-press the button to toggle the latch feature on/off. When the latch is set to on, the arpeggio keeps playing even after you take your hand off the keyboard.

## | TEMPO

You can set the tempo by tapping the ARPEGGIATOR TEMPO button several times at the timing you desire (the button blinks at the tempo you specify). This lets you control the playback speed of the arpeggiator and the loop recorder, the LFO and the various effect parameters.

Long-press the button to make the current tempo stay the same even when you switch to another program (TEMPO LOCK).

You can also set the tempo with the Tempo parameter in ARP A.

## STEP On/Off

When you press the EDIT ARP A button, you can use the PROGRAM NUMBER 1-8 buttons to toggle the steps on/off for the arpeggio while the ARP A/B pages are shown (blinking). The buttons light up when the steps are on.

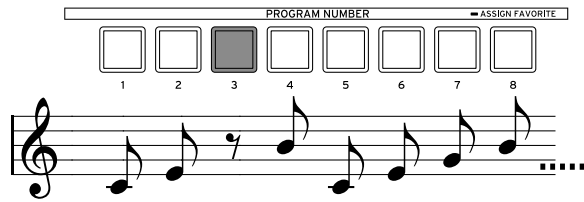
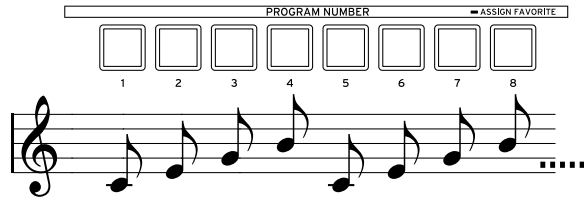

Type: Up Last Step: 8

*Note:* If the EDIT ARP A button is not blinking, press the PROGRAM NUMBER 1-8 buttons to switch between programs. Be careful, as the edits you made to the program are lost if you have not saved them.

# ARP A, B

## ARP A



### 1. Tempo [30...300]

This sets the tempo at which the arpeggiator plays.

This setting also affects the loop recorder playback speed, the LFO and the various effect parameters.

The knob changes the value in steps of two if the value is set to 270 or greater. Use the INC/DEC buttons to change the value in steps of one.

*Note:* If the global MIDI Clock Source is set to "External USB/MIDI", or if it is set to "Auto" when there is an external input, this tempo setting is ignored and the instrument synchronizes to the external MIDI clock.

### 2. Swing [-100%...0...+100%] NRPN 0, 5

Specifies the percentage (%) by which even-numbered notes of the arpeggio are shifted in timing relative to the first note.

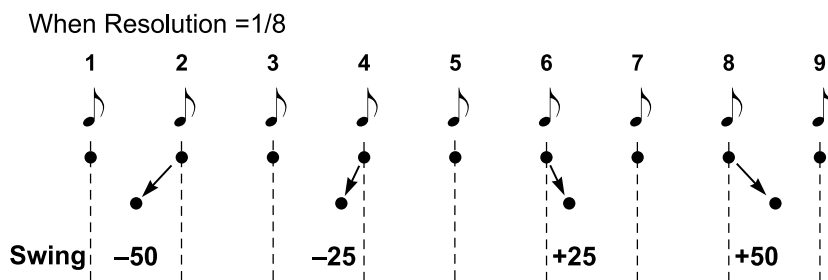

### 3. Resolution [1/32, 1/24, 1/16, 1/12, 1/8, 1/6, 1/4] (NRPN 0, 6)

Sets the resolution (intervals between the notes) relative to the specified tempo.

**1/32:** The arpeggio plays as thirty-second notes of the specified tempo.

**1/24:** The arpeggio plays as sixteenth note triplets of the specified tempo.

**1/16:** The arpeggio plays as sixteenth notes of the specified tempo.

**1/12:** The arpeggio plays as eighth note triplets of the specified tempo.

**1/8:** The arpeggio plays as eighth notes of the specified tempo.

**1/6:** The arpeggio plays as quarter note triplets of the specified tempo.

**1/4:** The arpeggio plays as quarter notes of the specified tempo.

**4. Target Timbre (Target) [Both Timbre, Timbre 1, Timbre 2] (NRPN 0, 11)**

Selects the timbres that are played by the arpeggiator.

**Both Timbre:** Both timbres are played by the arpeggiator.

**Timbre 1:** Only timbre 1 is played by the arpeggiator.

**Timbre 2:** Only timbre 2 is played by the arpeggiator.

*Note:* This setting is available when Timbre Mode is "Dual".

**5. Latch [Off, On] (NRPN 0, 4)**

Sets how the arpeggiator works when you take your hand off of the keyboard.

**Off:** The arpeggiator stops playing when you take your hand off the keyboard.

**On:** The arpeggiator keeps playing even if you take your hand off the keyboard.

*Tip:* You can also toggle the latch by long-pressing the ARPEGGIATOR ON button.

## ARP B

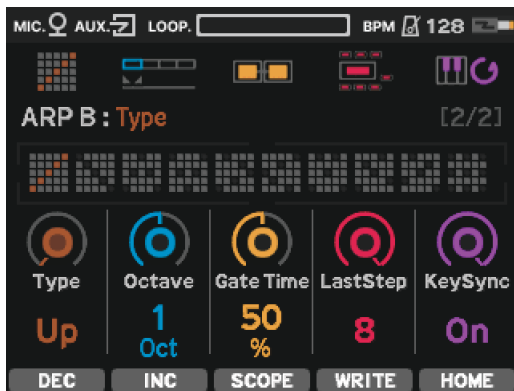

**1. Type [Up, ..., Trigger] NRPN 0, 7**

Selects the arpeggio type.

**Up:** Notes are played consecutively from low pitches to high.



**Down:** Notes are played consecutively from high pitches to low.



**UpDown:** Alternates between playing the notes up and then down. (The highest and lowest notes play once.)



**DownUp:** Alternates between playing the notes down and then up. (The highest and lowest notes play once.)



**Converge:** The arpeggiator plays notes by “converging” towards the middle note of the chord, with the lowest note first followed by the highest note, then the second-lowest note followed by the second-highest note and so forth.



**Diverge:** The arpeggiator plays notes by “diverging” away from the middle notes of the chord towards the outer (lowest and highest) notes.



**Manual:** The arpeggio plays in the order you play the keys.



**Random 1:** The notes you play are triggered randomly.



**Random 2:** The notes you play are triggered randomly. Use this setting when you don’t want the same notes to be triggered consecutively.



**Trigger:** The notes you hold down on the keyboard are played using chords.

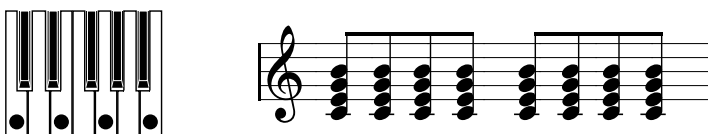

## 2. Octave Range (Octave) [1 Oct...4 Oct] (NRPN 0, 8)

Specifies the range of octaves over which the arpeggio is played.

**3. Gate Time** [0%...100%] (NRPN 0, 10)

Specifies the duration (gate time) of the arpeggiated notes, as a percentage (%).

With a setting of **0**, each note will be extremely short. With set to **100**, each note will continue playing until the next step.

**4. Last Step** [1...8] (NRPN 0, 9)

Sets the number of valid steps (maximum number of steps) for the step arpeggiator.

**5. Key Sync** [Off, On] (NRPN 0, 12)

Sets whether the arpeggiator and keyboard are synchronized.

**On:** The arpeggiator pattern starts playing from the beginning, starting with the first note you play (note-on) after you've taken your hands completely off the keyboard. This works best when you are playing in real time, to match the timing of when the measure starts.

**Off:** The arpeggiator always follows the clock.

# GLOBAL, CONTROL, MIC, MIDI, MIDI FILTER

## GLOBAL

The GLOBAL parameters are used for configuring the overall settings of the microKORG2.

For instance, although you can set the pitch for each synth program individually, the global pitch settings (Tuning, Transpose) let you change the pitch for all programs.

Use the Tuning parameter to adjust the pitch of the microKORG2 to other instruments when you're playing in an ensemble setting; and use the Transpose parameter to transpose the pitch of a song that you're playing.

If you want to perform with more than one program during a single song, you can simply use the global settings to change the pitch, without modifying the pitch for each program.

*Note:* The settings for GLOBAL, CONTROL, MIC, MIDI and MIDI FILTER are saved when you exit the GLOBAL section.



### 1. Tuning [430.0...440.0...450.0 Hz]

Sets the overall pitch produced by this instrument within the range of 430.0-450.0 Hz in 0.1 Hz units, with A4 as a base.

Use this when you want to match the pitch of the microKORG2 to other musical instruments.

### 2. Transpose [-12...0...12]

Adjusts the overall pitch in semitone (100 cent) steps over the range of  $\pm 1$  octave.

Use this when you want to match the key of the music you're playing with.

### 3. Aux Routing (AuxRoute) [pre Mod, ..., post MasterVol]

Sets the position in the signal chain at which the audio signal from the AUX IN jack is mixed.

**pre MOD:** The signal is input before the Mod effect. As a result, effects from Mod onward are applied to the signal.

**pre DELAY:** The signal is input before the Delay effect. As a result, effects from Delay onward are applied to the signal.

**pre REVERB:** The signal is input before the Reverb effect. As a result, effects from Reverb onward are applied to the signal.

**pre EQ:** The signal is input before the equalizer. As a result, effects from equalizer onward are applied to the signal.

**pre LoopRec:** The signal is input before the loop recorder. As a result, effects are not applied, and you can record the signal directly into the loop recorder.



**post MastrVol:** The signal is input after the master volume. With this setting, you can't use the master volume knob to adjust the volume.

⚠ Use caution with the volume when using the post MastrVol setting, as the input audio is much louder than with other settings.

#### 4. Battery Type (Battery) [Alkaline, Ni-MH]

To make sure the correct battery level is displayed, set which type of battery you are using.

**Alkaline:** alkaline batteries

**Ni-MH:** nickel-metal hydride batteries

#### 5. Auto Power Off (AutoP.Off) [Disable, Enable]

Sets whether the auto power-off function is enabled or disabled.

**Disable:** The auto power-off function is disabled.

**Enable:** The power automatically turns off when two hours have elapsed since you operated the microKORG2.

→ [Auto power-off function](#)

## CONTROL

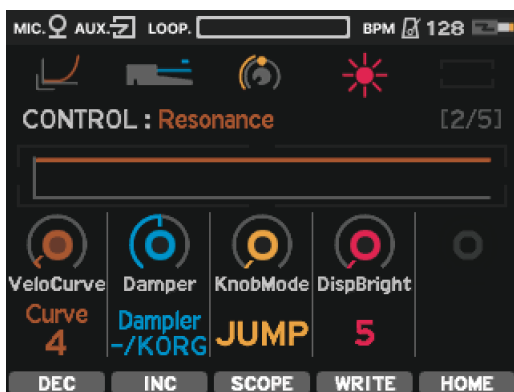

#### 1. Velocity Curve (VeloCurve) [Curve 1...8, Const Max]

Sets the curve that determines how sensitive the microKORG2 velocity calculation is to how hard you play the keyboard.

The velocity at which you play can change the volume or tonal color, so this setting lets you adjust the overall sensitivity at which the volume and tonal color change according to your playing strength.

**1, 2, 3:** With this curve, the response sensitivity is lower than normal, making it easier to play expressively when you play the keys with greater force.

**4:** This is the typical curve.

**5, 6:** These curves let you produce dynamic change without having to play very hard.

**7:** This curve provides a nearly flat key response, with almost no change in volume when you're playing with moderate force.

**8:** This curve provides a nearly flat key response (but is more flat than curve #7), with almost no change in volume when you're playing with moderate force.

**Const Max:** Plays at the maximum velocity value (127).

*Note:* The curves for 7 and 8 have only a minimal change in volume when you play the keys with moderate force, and work well when velocity response is not important or when you want the notes to play at a uniform volume. However, these curves are hard to control when you play softly, as the changes in volume are large. Select the curve that's most appropriate for your playing dynamics (velocity) or for the desired effect.

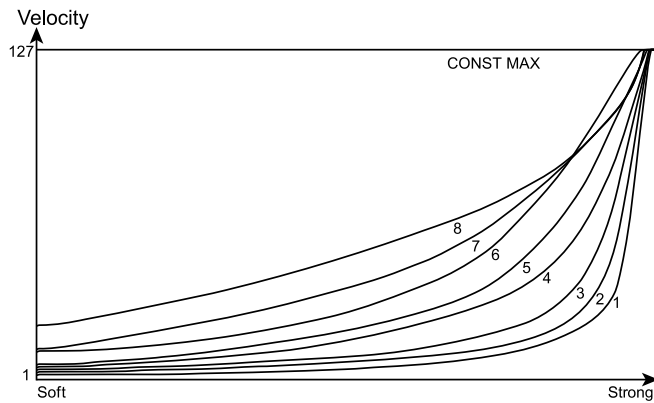

**2. Damper** [Damper -/KORG, Damper +, LoopRec -/KORG, LoopRec +]

Sets the functionality and polarity of the damper pedal connected to the DAMPER jack.

*Note:* The damper pedal may not work correctly if the polarity setting doesn't match.

*Note:* The microKORG2 does not have a half-damper function.

**Damper -/KORG:** The pedal functions as a damper pedal. This is the factory default setting. Use this setting when using a Korg DS-1H, PS-1 or PS-3 pedal.

**Damper +:** The pedal functions as a damper pedal. Use this setting when the pedal works in reverse.

**LoopRec -/KORG:** With this setting, you can record with the loop recorder while playing and use the damper pedal to enter record mode. Use this setting when using a Korg DS-1H, PS-1 or PS-3 pedal.

**LoopRec +:** Sets the damper pedal to work as the record function of the loop recorder. Use this setting when the pedal works in reverse.

**3. Knob Mode (KnobMode)** [Jump, Catch]

This sets how the EDIT CONTROL knobs behave when the position of the knob on the panel does not match the internal parameter value.

**Jump:** When you turn a knob, the parameter value jumps to the value indicated by the knob. Since this makes it easy to hear the results while editing, we recommend that you use this setting.

**Catch:** The parameter value does not change when you turn the knob, until it matches (or “catches up” to) the value indicated by the knob. We recommend that you use this setting when you don't want the sound to change abruptly, such as during a live performance.

For example, let's say that when you edit a parameter, the EDIT CONTROL 1 knob is in the position indicated by the figure.

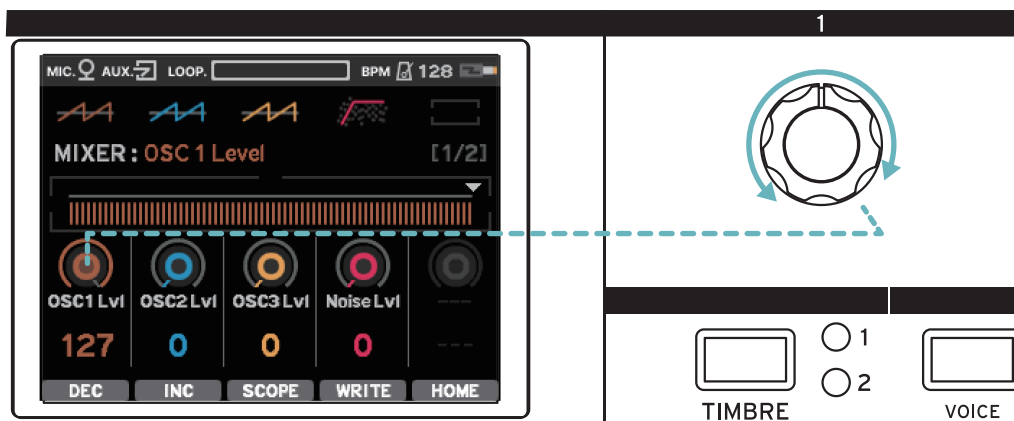

When you switch to a different section, the displayed parameter value for knob 1 may differ from the actual position of the knob. In this case, the value will not change until the knob position and the displayed parameter value match.

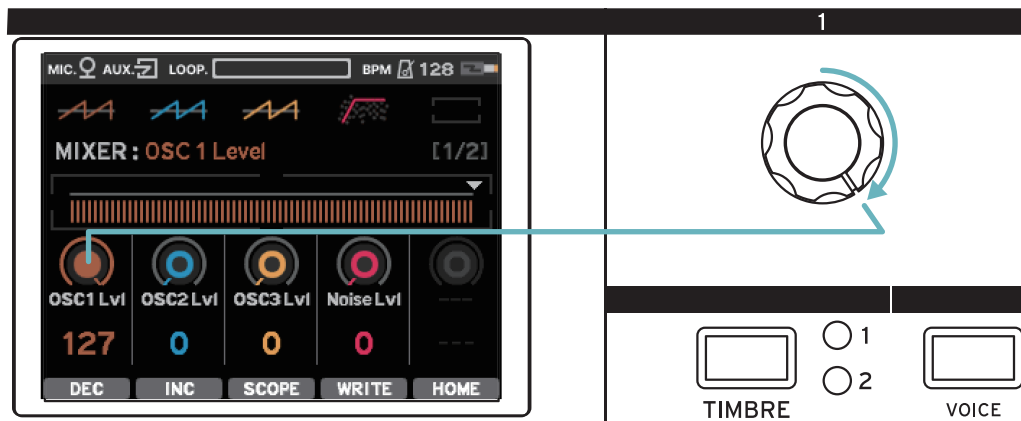

#### 4. Display Brightness (DispBright) [1...10]

Sets the display brightness.

- ⚠ If you continue using this instrument while the brightness is set to a high value, this has an effect on the life of the display.

## MIC

These are the settings for the noise gates and filters that are applied to the mic or other audio signal connected to the MIC IN CONDENSER or DYNAMIC jack.

Use the MIC knob to configure the mic input.

#### 1. Gate Threshold (Gate Thres) [0...127]

Sets the level at which the mic input is silenced.

The noise gate can be used to silence quieter sounds and allow louder sounds to pass through.

If the mic is picking up unwanted noise when you raise the mic volume, you can set this value so that any noise that's quieter than the Gate Threshold is cut. This preserves only the input audio you want, such as your vocals.

Lower values allow sounds at lower volumes to pass through as well. This is recommended when you're playing in quieter places. Higher values make it easier to cut through loud noise.

*Note:* If this setting is set excessively high, the audio signal input will also be cut, making it difficult to apply the vocal processor effects.

#### 2. Gate Speed (GateSpeed) [0...127]

Sets how quickly the gate responds to mic input signals.

Lower values for this setting make the gate operate quicker, making the rises and falls in volume sound clear. Higher values make the gate operate slower, reducing the chance of unwanted dropouts in the sound.

The gate works differently according to the Gate Threshold setting. If the Gate Threshold value is high, this effect is triggered more readily. If the threshold value is 0, no effect is applied.

#### 3. High Pass Filter (HPF) [0...127]

Cuts the low-end frequencies of the audio signal input from the MIC IN (CONDENSER and DYNAMIC) jacks. This makes the sounds lighter and clearer by eliminating any murky-sounding low-end audio.

#### 4. NoteOn Threshold (NoteThres) [0...127]

Sets the level at which audio signals are detected as notes after the Gate Threshold and High Pass Filter are applied.

## 5. Vocal MIDI Out (MIDI Out) [Disable, 1...16 Ch]

Sets the MIDI channel used for transmitting note messages corresponding to the pitch that's detected by the vocal processor. These messages are not transmitted when this is set to "Disable".

*Note:* Note messages are transmitted when Scale/Keyboard in VOCAL SETTING is set to "Scale".

## MIDI

Here's where you can configure the MIDI settings for the microKORG2.

MIDI stands for Musical Instrument Digital Interface, and is a worldwide standard for exchanging various types of musical data between electronic musical instruments and computers. When MIDI cables are used to connect two or more MIDI devices or computers, performance data can be exchanged between them, even if they were made by different manufacturers.

On the microKORG2, control change numbers are assigned to the main parameters that alter the sound, and you can use an external MIDI sequencer to trigger the sound generator while controlling these parameters. → [MIDI Implementation Chart](#)

You can also synchronize the arpeggiator, LFO cycle effect delay time and so on to the MIDI clocks received from your DAW or similar software, making the microKORG2 follow your playing.

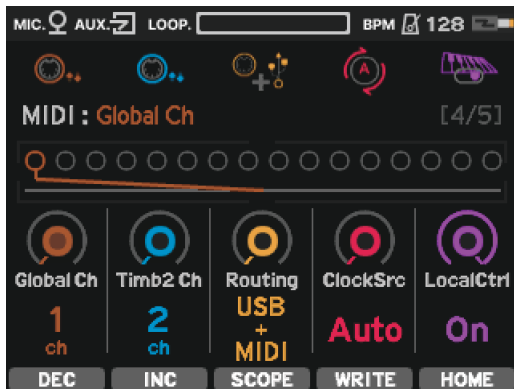

### 1. Global Ch [1...16 Ch]

Sets the global MIDI channel.

This MIDI channel is used to transmit and receive note messages, bend messages and control change messages for Timbre 1.

### 2. Timbre 2 Ch (Timb2 Ch) [1...16 Ch]

Sets the MIDI channel that Timbre 2 will send and receive MIDI messages on. Timbre 2 will sound when a note message is received via this MIDI channel.

### 3. Routing [USB+MIDI, USB]

Sets the routing for MIDI messages.

**USB+MIDI:** Message input is received from both the USB port and MIDI IN connector, and messages are output from this port and connector as well.

**USB:** Messages are only transmitted and received via the USB port.

### 4. Clock Source (ClockSrc) [Auto, Internal, External USB, External MIDI]

Sets the clock to which the arpeggiator is synchronized.

*Tip:* This also affects the LOOP RECORDER, LFO and DELAY.

**Auto:** When MIDI clock messages are not being input, the instrument uses the internal clock; when MIDI clock messages are being input, the instrument synchronizes to the clocks received via either the USB port or the MIDI IN connector.

**Internal:** Synchronizes to the internal clock.

**External USB:** Synchronizes to the clocks received via the USB port.

**External MIDI:** Synchronizes to the clocks received via the MIDI IN connector.

*Note:* If Clock Source is set to “External USB” or “External MIDI” and there is no external clock input, the arpeggiator, LOOP REC and LFOs also stop. If the DELAY effect parameter “Bpm Sync” is set to “On”, the delay will operate as though the system tempo is 30 BPM.

### **5. Local Control (LocalCtrl) [Off,On]**

Turns the local control on/off.

**Off:** The keyboard and wheel operations are internally disconnected from the sound generator of this instrument.

Use this when you want to avoid doubling of notes (“echo-back”) while the microKORG2 is connected to an external sequencer. (Echo-back occurs when you play a note on this instrument, the performance data is transmitted to an external sequencer and the same data is sent back to trigger the microKORG2.)

**On:** Set this when you want to use the microKORG2 on its own.

## **| MIDI settings for connecting to another MIDI device or computer**

### **MIDI channel and connection settings**

To exchange data with a connected external MIDI device, you must set the MIDI channel of the microKORG2 to match the MIDI channel of your external MIDI device. Use the steps below to set the MIDI channel.

- 1** Press the EDIT GLOBAL button to access the MIDI page.
- 2** Use knob 1 to select Global Ch, where you can set the global MIDI channel.
- 3** Use knob 2 to select “Timbre 2Ch (Timb2 Ch)” when you want to set Timbres 1 and 2 to different MIDI channels for receiving data. Timbre 1 receives data on the channel that’s set in Global Ch.
- 4** Use knob 3 to set the Routing, which selects whether to use either the MIDI connector or the USB port to exchange MIDI data with an external device.
- 5** Set this to the MIDI channel of the external MIDI device that you connected.

*Tip:* See the Owner’s Manual of your external MIDI device or DAW for details on other settings that need to be made.

### **MIDI local settings for connecting to an external MIDI sequencer or computer**

If the microKORG2 is connected to an external MIDI sequencer or computer and the echo back setting of the external MIDI sequencer or computer is turned on while the microKORG2’s Local Control setting is also on, the performance data generated when you play the microKORG2’s keyboard is sent to the external MIDI sequencer, and is also echoed back to trigger the microKORG2’s tone generator a second time. To prevent this kind of echo-back from happening, you can turn off Local Control on the microKORG2.

- 1** Press the EDIT GLOBAL button to access the MIDI page.
- 2** Use knob 5 to set Local Control (LocalCtrl) to “Off”.

## Synchronizing the arpeggiator playback

### Synchronizing an external MIDI device to the tempo of the microKORG2

Connect the microKORG2's MIDI OUT connector to your external MIDI device's MIDI IN connector, or connect the USB ports of both devices.

- 1 Press the EDIT GLOBAL button to access the MIDI page.
- 2 Use knob 4 to set Clock Source (ClockSrc) to "Internal". This makes the microKORG2 transmit MIDI timing clocks.
- 3 Configure your external MIDI device to receive MIDI clock data.  
This makes your external MIDI device (such as a sequencer or rhythm machine) operate at the tempo you specify using the Tempo parameter on the EDIT ARP A page.

### Setting an external MIDI device as the controller and the microKORG2 as the follower

Connect the microKORG2's MIDI IN connector to your external MIDI device's MIDI OUT connector, or connect the USB ports of both devices.

- 1 Press the EDIT GLOBAL button to access the MIDI page.
- 2 Use knob 4 to set Clock Source (ClockSrc) to "External MIDI" or "External USB".  
This makes the microKORG2 receive MIDI timing clocks from your external MIDI device.
- 3 Configure your external MIDI device to transmit MIDI clock data.  
The arpeggiator on the microKORG2 now operates in time with the tempo of the external MIDI device (such as a sequencer or rhythm machine).

When Clock Source (ClockSrc) on the EDIT MIDI page is set to "Auto" and a MIDI clock is received from either an external MIDI device connected to the MIDI IN connector of the microKORG2 or a device like a computer that's connected to the USB port on the microKORG2, the microKORG2 automatically works in "External MIDI" or "External USB" mode. Otherwise, the microKORG2 works in "Internal" mode.

*Tip:* See the Owner's Manual of your external MIDI device for details on synchronization-related settings for external MIDI devices.

## MIDI FILTER

These settings determine whether each type of MIDI data is transmitted and received.



### 1. Program Change (ProgChg) [Disable, Enable]

Sets whether program changes are transmitted and received.

**Disable:** Program change messages are not transmitted or received.

**Enable:** Program change messages are transmitted and received.

**2. Control Change (CC) [Disable, Enable]**

Sets whether MIDI control change messages are transmitted and received.

**Disable:** MIDI control change messages are not transmitted or received.

**Enable:** MIDI control change messages are transmitted and received.

**3. Pitch Bend (PitchBend) [Disable, Enable]**

Sets whether pitch bend data is transmitted and received.

**Disable:** Pitch bend data is not transmitted or received.

**Enable:** Pitch bend data is transmitted and received.

**4. System Ex (SysEx) [Disable, Enable]**

Sets whether MIDI system exclusive messages are transmitted and received.

**Disable:** MIDI system exclusive messages are not transmitted or received.

**Enable:** MIDI system exclusive messages are transmitted and received.

## VOCAL PROCESSOR section

---

- [ON/OFF](#)
- [VOCODER](#)
- [HARD TUNE](#)
- [HARMONIZER](#)
- [VOCAL SETTING](#)



## ON/OFF

---

- Press the VOCODER, HARD TUNE, HARMONIZER, MOD, DELAY, REVERB or EQ button while holding down the ON/OFF button to turn the respective effects on/off (the LED below each button will light up when the effect is on).
- Long-press the VOCODER, HARD TUNE or HARMONIZER button to access the VOCAL SETTING page, where you can choose whether to correct the pitch according to the scale or the keyboard.  
→ [VOCAL SETTING](#)

# VOCODER

- Press the VOCODER button while holding down the ON/OFF button to turn the effect on/off (the LED below the button lights up when the effect is on).

*Note:* You can't use the VOCODER at the same time as the other two effects. However, the HARD TUNE and HARMONIZER effects can be used at the same time.

- Press the VOCODER button to show the related parameters (the button blinks). Use the EDIT CONTROL 1-5 knobs and the FUNCTION 1, 2 buttons to set the value.
- Long-press the VOCODER, HARD TUNE or HARMONIZER button to access the VOCAL SETTING page, where you can choose whether to correct the pitch according to the scale or the keyboard.  
→ [VOCAL SETTING](#)

## VOCODER

Here are the parameters related to the vocoder.

These parameters are related to the bandpass filters on the carrier side and the envelope follower on the modulator side, and are frequently used when shaping the character of the vocoder.



### 1. Mic Direct Level (Mic Direct) [0...127] (NRPN 5, 1)

Sets the volume level at which the mic input is output directly without going through the modulator.

### 2. Synth Dry/Wet (Synth D/W) [0...100%] (NRPN 5, 2)

Sets the balance between the synth sound that doesn't go through the vocoder, and the sound of the vocoder itself.

### 3. Formant [-63...0...63] (NRPN 5, 3)

This continuously shifts the cutoff frequency of each bandpass filter of the carrier.

### 4. Resonance [0...127] (NRPN 5, 4)

Sets the amount of resonance for each bandpass filter of the carrier.

Increasing this value will emphasize the regions near each cutoff frequency.

### 5. Env Follower Sens (E.F.Sens) [0...126, Hold] (NRPN 5, 5)

Sets the sensitivity of the envelope follower for the modulator.

Lower values allow the attack portion and other rises in the input signal to be detected more rapidly. If you set this to "Hold", the character of the signal that is being input at that moment will be held. After this, the sound retains that character regardless of whether there is any input.

*Tip:* The signal information that's maintained in the hold state can be saved in the program by writing the program. If you set this to "Hold" without an input signal present, no output is made even if an audio signal is input after this.

## | FILTER BAND

On the FILTER BAND page, you can set the output level and panpot (stereo position) for the 16 filters on the carrier side.



### 1. Band Select (Band Sel) [1...16]

Selects which bandpass filter the Level and Pan parameters will affect.

*Note:* This setting is not saved in the program. When you turn on the microKORG2 or select a different program, this value is reset to "1".

### 2. Band X Level (Level) [0...127] (NRPN 5, 16...31)

Sets the output level for the filter that's selected in Band Select.

### 3. Band X Pan (Pan) [L63...L1, Center, R1...R63] (NRPN 5, 32...47)

Sets the panpot for the filter that's selected in "Band Select".

# HARD TUNE

- Press the HARD TUNE button while holding down the ON/OFF button to turn the effect on/off (the LED below the button lights up when the effect is on).
- Press the HARD TUNE button to show the related parameters (the button blinks). Use the EDIT CONTROL 1-5 knobs and the FUNCTION 1, 2 buttons to set the value.
- Long-press the VOCODER, HARD TUNE or HARMONIZER button to access the VOCAL SETTING page, where you can choose whether to correct the pitch according to the scale or the keyboard.  
→ [VOCAL SETTING](#)

## HARD TUNE

This effect is for adjusting or correcting the vocal pitch.

Use this to create robot-like voices, or to adjust the formant for a thicker, lower vocal sound or for a thinner, higher sound.



### 1. Intensity [0...127] (NRPN 6, 1)

Adjusts the amount of hard tune effect that's applied.

When the value is "0", no hard tune is applied. Set this to a larger value when you want to create a stronger hard tune effect with pitch correction.

### 2. Speed [0...127] (NRPN 6, 2)

Sets the speed of pitch correction.

When this is set to "0", the pitch is corrected instantly. Larger values slow down the pitch correction time.

### 3. Formant [-63...0...63] (NRPN 6, 3)

Adjusts the formant to change the vocal character.

This lets you change the vocal input signal into a thick, low voice (negative values) or into a thin, high voice (positive values).

# HARMONIZER

- Press the HARMONIZER button while holding down the ON/OFF button to turn the effect on/off (the LED below the button lights up when the effect is on).
- Press the HARMONIZER button to show the related parameters (the button blinks). Use the EDIT CONTROL 1-5 knobs and the FUNCTION 1, 2 buttons to set the value.
- Long-press the VOCODER, HARD TUNE or HARMONIZER button to access the VOCAL SETTING page, where you can choose whether to correct the pitch according to the scale or the keyboard.  
→ [VOCAL SETTING](#)

## HARMONIZER A (HARMO A)

Adds harmonies (chord tones) to the vocal by shifting the original pitch of the vocal and outputting the result.

You can output up to two harmonies in addition to the original sound.

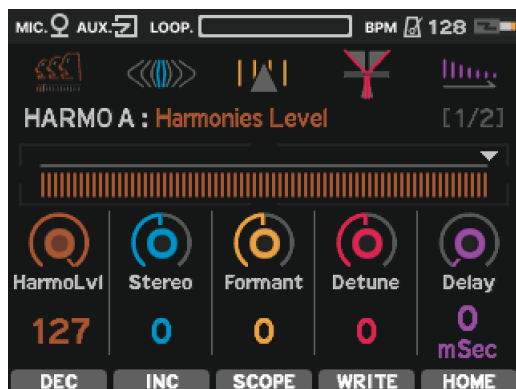

### 1. Harmonies Level (HarmoLvl) [0...127] (NRPN 7, 1)

Sets the output level of the harmony sound.

### 2. Stereo Spread (Stereo) [-63...0...63] (NRPN 7, 2)

Sets the relative amount that the harmonies are spread out over the stereo field.

When Harmony Number is set to "1", the harmony moves from left to right.

When Harmony Number is set to "2", harmony 1 will move from left to right and harmony 2 will move from right to left.

### 3. Formant [-63...0...63] (NRPN 7, 3)

Adjusts the formant of the harmony sound to change the vocal character.

This lets you change a thin, high voice into a thick, low voice (negative values), or a thick, low voice into a thin, high voice (positive values).

### 4. Pitch Detune (Detune) [-63...0...63] (NRPN 7, 4)

Sets how much to detune (adjust the pitch slightly out of tune) the harmony sound.

### 5. Delay [0...150 mSec] (NRPN 7, 5)

Sets how much to delay the output of the harmonies in respect to the original sound.

## HARMONIZER B (HARMO B)



### 1. Harmony Number (Harmony) [1, 2] (NRPN 7, 16)

Sets the number of harmonies to output.

### 2. Harmony 1 Pitch (Pitch 1) [-2 Oct...-2nd, Unison, +2nd...+2 Oct] (NRPN 7, 32)

Sets how much to shift the pitch of harmony 1 in scale steps.

*Note:* Some scale intervals (such as a 2nd) may not be indicated, depending on the Scale Type in VOCAL SETTING.

### 3. Harmony 2 Pitch (Pitch 2) [-2 Oct...-2nd, Unison, +2nd...+2 Oct] (NRPN 7, 48)

Sets how much to shift the pitch of harmony 2 in scale steps.

This can be set when Harmony Number is set to "2".

# VOCAL SETTING

These parameters set how the vocal sound is controlled when you're using the vocoder, hard tune or harmonizer.

- Long-press the VOCODER, HARD TUNE or HARMONIZER button to access the VOCAL SETTING page.

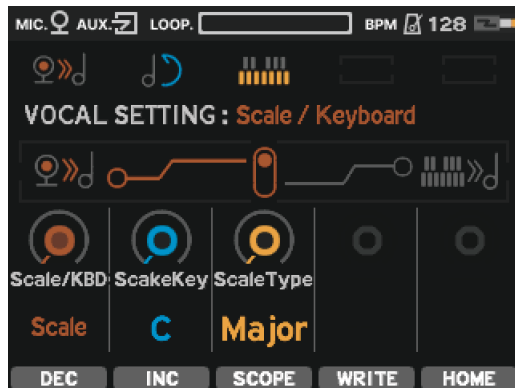

## 1. Scale/Keyboard (Scale/KBD) [Scale, Keyboard]

When using the vocoder, this sets whether the synth engine is triggered by the mic input signal or the keyboard.

When using the hard tune or harmonizer, this sets whether the vocal pitch correction or harmonization follows the scale notes or the keyboard.

**Scale:** The vocal pitch is corrected to match the scale you set using "Scale Key" and "Scale Type".

**Keyboard:** The pitch is corrected to match the keys you play on the keyboard.

## 2. Scale Key (ScaleKey) [C, C#, D, D#, E, F, F#, G, G#, A, A#, B]

When Scale/Keyboard is set to "Scale", this specifies the key of the scale used to correct the pitch.

## 3. Scale Type (ScaleType) [Major, minor, Major Penta, minor Penta, Major Blues, minor Blues, Raga, Japanese, BassLine, 4th, 5th, Chromatic]

When Scale/Keyboard is set to "Scale", this specifies the scale (notes in the key) used to correct the pitch.

When using the harmonizer, harmonies are output according to the notes in the scale.

## EFFECT, EQ section

---

- [Modulation \(MOD\)](#)
- [DELAY](#)
- [REVERB](#)
- [EFFECT ROUTING](#)
- [EQ](#)



## Modulation (MOD)

The modulation effect applies various types of cyclic change to the original sound. This gives the sound greater depth, or produces the impression that multiple sound sources are being heard simultaneously.

You can use modulation effects, a compressor, amp simulator and so on.

- Press the MOD button while holding down the ON/OFF button to turn the effects on/off (the LED below the button lights up when the effect is on).
- Press the MOD button to access the related parameters (the button blinks). Use the EDIT CONTROL 1-5 knobs and the FUNCTION 1, 2 buttons to set the value.
- Long-press either the MOD, DELAY or REVERB button to access the EFFECT ROUTING page, where you can set the effect to which each timbre and the mic audio is sent. → [EFFECT ROUTING](#)
- Use the Effect Type parameter (knob 1) to select the effect type. The parameters shown below (knobs 2-5) depend on the effect type.

### MOD

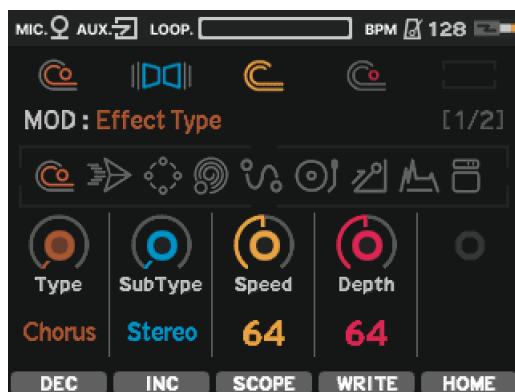

#### 1. Effect Type (Type) [Chorus, Flanger, Ensemble, Phaser, Tremolo, LoFi, Comp, Distortion, Amp Simulator]

Selects the effect type.

#### 2...5. Effect Parameters

This configures the parameters of each effect.

For more on the parameters, refer to the explanations for each effect type.

### MOD EXTRA

#### 1...5. Effect Parameters

This configures the parameters of each effect.

For more on the parameters, refer to the explanations for each effect type.

## | Effect Type

### Chorus

Chorus is an effect created by modulating a delay to change the pitch of a signal. Mixing the modulated signal with the unmodulated signal creates an imitation of the slight (or not so slight) differences in intonation between two musicians playing in unison, while the modulated signal on its own can be used as a vibrato.

#### MOD

##### 1. Effect Type (Type) Chorus

##### 2. Chorus Sub Type (SubType) [Stereo, Light, Mono, Vibrato, Manual]

Selects one of the available sub types.

##### 3. Speed [0...127] (CC#12)

Adjusts the rate of the modulation effect, depending on the range of the selected subtype. Turning the knob to the right will increase how fast the effect modulates the input signal.

*Note:* When the "Manual" sub-type is selected, the Speed parameter won't change the sound, as the internal LFO is stopped.

##### 4. Depth [0...127] (CC#111)

This sets the intensity of the effect. Turning the knob to the right will increase the intensity.

#### MOD EXTRA

##### 1. Low Cut (LowCut) [0...127]

Adjusts the cutoff frequency of the high-pass filter. Turning the knob to the right will reduce the amount of low frequency sound.

##### 2. Manual [0...127]

Adjusts the delay offset of the effect. Turning the knob to the right increases the offset.

##### 3. Width [0...127]

Sets the stereo spread of the effect. Turning the knob to the right will increase the width of the stereo field.

##### 5. Dry/Wet [0...100 %]

This sets the mix of the unprocessed (dry) and processed (wet) signals. Turning the knob to the right will increase the wet level and decrease the dry level.

### Flanger

An effect that produces an intense undulating effect.

#### MOD

##### 1. Effect Type (Type) Flanger

##### 2. Flanger Sub Type (Sub Type) [Stereo +, Stereo -, Light +, Light -, Mono +, Mono -, Manual]

Selects one of the available sub types.

##### 3. Speed [0...127] (CC#12)

Adjusts the rate of the modulation effect, depending on the range of the selected subtype. Turning the knob to the right will increase how fast the effect modulates the input signal.

**4. Depth** [0...127] (CC#111)

This sets the intensity of the effect. Turning the knob to the right will increase the intensity.

**MOD EXTRA**

**1. Low Cut (LowCut)** [0...127]

Adjusts the cutoff frequency of the high-pass filter. Turning the knob to the right will reduce the amount of low frequency sound.

**2. Manual** [0...127]

Adjusts the delay offset of the effect. Turning the knob to the right increases the offset.

**3. Width** [0...127]

Sets the stereo spread of the effect. Turning the knob to the right will increase the width of the stereo field.

**4. Feedback** [-63...0...63]

Sets the amount of the output signal that will be routed back to the input of the effect, creating intense resonant peaks. Turning the knob to the right of center will increase the amount of feedback, while turning the knob to the left of center will increase the amount of feedback and invert the phase of the feedback, shifting the resonant peaks.

**5. Dry/Wet** [-100...0...100 %]

This sets the mix of the unprocessed (dry) and processed (wet) signals. Turning the knob to the right of center will increase the wet level and decrease the dry level, while turning the knob to the left of center will increase the inverted wet level and decrease the dry level.

**Ensemble**

A rich chorus-like effect.

**MOD**

**1. Effect Type (Type)** Ensemble

**2. Ensemble SubType (SubType)** [Stereo, Light, Mono]

Selects one of the available sub types.

**3. Speed** [0...127] (CC#12)

Adjusts the rate of the modulation effect, depending on the range of the selected subtype. Turning the knob to the right will increase how fast the effect modulates the input signal.

**4. Depth** [0...127] (CC#111)

This sets the intensity of the effect. Turning the knob to the right will increase the intensity.

**MOD EXTRA**

**1. Low Cut (LowCut)** [0...127]

Adjusts the cutoff frequency of the high-pass filter. Turning the knob to the right will reduce the amount of low frequency sound.

**3. Width** [0...127]

Sets the stereo spread of the effect. Turning the knob to the right will increase the width of the stereo field.

**5. Dry/Wet** [0...100 %]

This sets the mix of the unprocessed (dry) and processed (wet) signals. Turning the knob to the right will increase the wet level and decrease the dry level.

## Phaser

An effect that changes the phase of a signal to create the impression of movement.

### MOD

**1. Effect Type (Type)** **Phaser**

**2. Phaser SubType (SubType)** [Stereo, Orange, Black, Small]

Selects one of the available sub types.

**3. Speed** [0...127] (CC#12)

Adjusts the rate of the modulation effect, depending on the range of the selected subtype. Turning the knob to the right will increase how fast the effect modulates the input signal.

**4. Depth** [0...127] (CC#111)

This sets the intensity of the effect. Turning the knob to the right will increase the intensity.

### MOD EXTRA

**1. Low Cut (LowCut)** [0...127]

Adjusts the cutoff frequency of the high-pass filter. Sounds and harmonic components below the cutoff frequency will be attenuated. Turning the knob to the right will increase the cutoff frequency.

**2. Manual** [0...127]

Manually offsets the phaser coefficients, changing what frequencies are most affected. Turning the knob to the right increases the offset, shifting the range of the phaser up in frequency.

**3. Width** [0...127]

Sets the stereo spread of the effect. Turning the knob to the right will increase the width of the stereo field.

**4. Feedback** [-63...0...63]

Sets the amount of the output signal that will be routed back to the input of the effect, creating intense resonant peaks. Turning the knob to the right of center will increase the amount of feedback, while turning the knob to the left of center will increase the amount of feedback and invert the phase of the feedback, shifting the resonant peaks.

**5. Dry/Wet** [-100...0...100 %]

This sets the mix of the unprocessed (dry) and processed (wet) signals. Turning the knob to the right of center will increase the wet level and decrease the dry level, while turning the knob to the left of center will increase the inverted wet level and decrease the dry level.

## Tremolo

An effect that periodically modulates the amplitude of a signal.

### MOD

#### 1. Effect Type (Type) Tremolo

#### 2. Wave [Triangle, Square, Saw, Sine, Sample & Hold]

This sets the type of waveform that will modulate the amplitude of the input signal.

#### 3. Speed ["Bpm Sync" Off: 0...127 / "Bpm Sync" On: 1/1, 3/4, 1/2, 3/8, 1/3, 1/4, 3/16, 1/6, 1/8, 3/32, 1/12, 1/16, 1/24, 1/32, 1/64] (CC#12)

Adjusts the rate of the modulation effect, depending on the range of the selected subtype. Turning the knob to the right will increase how fast the effect modulates the input signal.

#### 4. Depth [0...127] (CC#111)

This sets the intensity of the effect. Turning the knob to the right will increase the intensity.

### MOD EXTRA

#### 1. Mode [Normal, Harmonic]

Switches between normal tremolo and harmonic tremolo.

Harmonic tremolo splits the input sound into high and low frequency bands and modulates the volume of each band to create a unique tremolo effect.

#### 2. Shape [0...127]

Sets the intensity of the processing done to the internal LFO. For Triangle, Saw, and Sine, turning the knob to the right makes the LFO curve more exponential. For Square and S&H, turning the knob to the right increases the amount of smoothing applied to the LFO output.

#### 3. BPM Sync (BpmSync) [Off / On]

Switches the speed parameter between absolute frequency in hz and tempo synced subdivisions.

#### 4. Inversion (Inv) [Positive, Negative]

Sets the polarity of the internal LFO.

#### 5. Width [0...127]

Sets the stereo spread of the effect. Turning the knob to the right will increase the width of the stereo field.

## LoFi

An effect that wobbles and distorts like an old record or tape player.

### MOD

#### 1. Effect Type (Type) LoFi

#### 2. LoFi SubType (SubType) [33.3 rpm, 45.0 rpm, 78.3 rpm]

Selects one of the available sub types.

#### 3. Wow Depth (Wow) [0...127] (CC#12)

This sets the intensity of the effect. Turning the knob to the right will increase the intensity.

**4. Isolation (Iso) [0...127] (CC#111)**

Sets the intensity of the isolator filter. Turning the knob to the right reduces the range of frequencies passed by the filter.

**5. Saturation (Satu) [0...127] (CC#112)**

Sets the intensity of the non-linear processing. Turning the knob to the right increases the amount of harmonic distortion.

**MOD EXTRA**

**2. Wow Random (WowRand) [0...127]**

Sets the intensity of the random modulation. Turning the knob to the right increases the amount that other modulators are affected by the random modulation.

**3. Wow Rate (WowRate) [0...127]**

Adjusts the rate of modulation. Turning the knob to the right will increase how fast the effect modulates the input signal.

**4. Iso Frequency (IsoFreq) [-63...0...63]**

Sets the center frequency of the isolator filter. Turning the knob to the right will increase the frequency.

**5. Iso Slope (IsoSlope) [0...127]**

Adjusts the order of the isolator filter. Turning the knob to the right will increase the intensity of the filter.

**Compressor (Comp)**

An effect that automatically reduces the level of a signal when the input crosses a set volume threshold.

**MOD**

**1. Effect Type (Type) Comp**

**2. Ratio [Soft, Medium, Hard, Limiter]**

Sets the ratio of the compressor.

Name	input: output reduction ratio
Soft	1:2
Medium	1:4
Hard	1:8
Limiter	1:100

**3. Time [-63...0...63] (CC#12)**

Scales the "Attack" and "Release" time of the compressor between 20%–500%.

**4. Depth [0...127] (CC#111)**

Sets the threshold of the compressor. Turning the knob to the right lowers the threshold.

**5. Output [-24...6 dB] (CC#112)**

Sets the output gain.

## MOD EXTRA

### 2. Knee [0...127]

Sets the smoothness of the transition between compressing and not compressing a signal.

### 3. Attack [0...127]

Sets the speed with which the envelope follower responds to increases in amplitude. Turning the knob to the right makes the response slower.

### 4. Release [0...127]

Sets the speed with which the envelope follower responds to decreases in amplitude. Turning the knob to the right makes the response slower.

### 5. Dry/Wet [0...100 %]

This sets the mix of the unprocessed (dry) and processed (wet) signals. Turning the knob to the right will increase the wet level and decrease the dry level.

## Distortion

An effect that offers several different types of harmonic distortion.

## MOD

### 1. Effect Type (Type) Distortion

### 2. Distortion Model (Model) [Overdrive, Dist, Tube, Decimator, Wavefold, Crash]

Selects the distortion model.

**Overdrive:** a gentle distortion

**Dist:** an intense distortion

**Tube:** a distortion that is similar to a famous guitar pedal

**Decimator:** a distortion that reduces the sample rate of a signal

**Wavefold:** a distortion that uses the input signal as the phase of an oscillator

**Crash:** a distortion that syncs an oscillator to the input signal

### 3. Tone [0...127] (CC#12)

Cuts the high frequency content of the distorted signal. Turning the knob to the left makes the signal darker.

### 4. Depth [0...127] (CC#111)

Sets the intensity of the distortion. Turning the knob to the right increases the intensity.

### 5. Output [0...127] (CC#112)

This sets the mix of the unprocessed (dry) and processed (wet) signals. Turning the knob to the right will increase the wet level and decrease the dry level.

## MOD EXTRA

### 2. Pre EQ Freq (EqFreq) [0...127]

Sets the frequency of the pre-distortion filter. Turning the knob to the right increases the frequency.

### 3. Pre EQ Gain (EqGain) [-63...0...63]

Sets the gain of the pre-distortion filter. Turning the knob to the left of center decreases the gain, and turning it to the right of center increases the gain.

**4. Post Low Cut (LowCut) [0...127]**

Adjusts the cutoff frequency of the output high pass filter. Sounds and harmonic components below the cutoff frequency will be attenuated. Turning the knob to the right will increase the cutoff frequency.

**5. Dry/Wet [0...100 %]**

This sets the mix of the unprocessed (dry) and processed (wet) signals. Turning the knob to the right will increase the wet level and decrease the dry level.

## **Amp Simulator**

An effect that emulates the distortion and timbre of a guitar amp.

### **MOD**

**1. Effect Type (Type) Amp Simulator**

**2. AmpSim Model (Model) [Clean, Vintage, Crunch, Dark, Hard, Heavy]**

Selects the type of amp model.

**3. Tone [0...127] (CC#12)**

Cuts the high frequency content of the distorted signal. Turning the knob to the left makes the signal darker.

**4. Depth [0...127] (CC#111)**

Sets the intensity of the effect. Turning the knob to the right makes the effect more intense.

**5. Output [-24...6] (CC#112)**

Adjusts the output volume. The output range is from -24 dB to +6 dB.

### **MOD EXTRA**

**2. Pre EQ Freq (EqFreq) [0...127]**

Sets the cutoff of the peaking EQ that processes the input to the amp sim. Turning the knob to the right increases the frequency.

**3. Pre EQ Gain (EqGain) [-63...0...63]**

Sets the gain of the peaking EQ that processing the input to the amp sim. Turning the knob right of center increases the boost, while turning the knob left of center increases the cut.

**4. Post Low Cut (LowCut) [0...127]**

Sets the cutoff frequency of the high pass filter that processes the output of the amp sim. Turning the knob right increases the cutoff frequency.

**5. Dry/Wet [0...100 %]**

This sets the mix of the unprocessed (dry) and processed (wet) signals. Turning the knob to the right will increase the wet level and decrease the dry level.



# DELAY

An effect that delays the signal and creates an echoing sound.

- Press the DELAY button while holding down the ON/OFF button to turn the effect on/off (the LED below the button lights up when the effect is on).
- Press the DELAY button to access the related parameters (the button blinks). Use the EDIT CONTROL 1-5 knobs and the FUNCTION 1, 2 buttons to set the value.
- Long-press either the MOD, DELAY or REVERB button to access the EFFECT ROUTING page, where you can set the effect to which each timbre and the mic audio is sent. → [EFFECT ROUTING](#)
- Use the Effect Type parameter (knob 1) to select the effect type. The parameters shown below (knobs 2-5) depend on the effect type.

## DELAY



### 1. Effect Type (Type) [Stereo, Ping Pong, Tape Echo, Pitch Shift, Reverse, LoRes]

Selects the effect type.

### 2...5. Effect Parameters

This configures the parameters of each effect.

For more on the parameters, refer to the explanations for each effect type.

## DELAY EXTRA

### 1...5. Effect Parameters

Selects the effect type.

## | Effect Type

### Stereo

Independently delays the left and right channels

### Ping Pong

A delay that alternates between left and right channels.

### Tape Echo

A delay that distorts and modulates the pitch of the signal like a tape machine.

### Pitch Shift

A delay that shifts the signal up or down.

### Reverse

A delay that plays backwards.

### LoRes

A delay that lowers the sample rate of the signal.

#### 1. Effect Type (Type) Stereo/Ping Pong/Tape Echo/Pitch Shift/Reverse/LoRes

#### 2. Effect Type-specific parameter

**Stereo: N/A (---)**

**Ping Pong: Stereo Width (Width) [0...127] (CC#115)**

Adjusts the mix of the ping pong delay outputs to create a left-to-right bouncing effect. Turning the knob right increases the width of the bouncing effect.

**Tape Echo: Instability (Insta) [0...127] (CC#115)**

Adjusts how intense the tape simulation is. Turning the knob to the right will make the delay less stable.

**Pitch Shift: Shift Mix (Shift) [-63...0...63] (CC#115)**

Shift Mix: Adjusts how much pitch shifted signal is mixed into the delay feedback and output. Turning the knob to the right of right and left of center will increase the amount of plus and minus one octave pitch shifted signal relative to the unshifted signal, respectively.

**Reverse: N/A (---)**

**LoRes: Reduction (Reduct) [0...127] (CC#115)**

Adjusts the amount of sample rate reduction within the delay. Turning the knob to the right will reduce the sample rate.

#### 3. Time ["Bpm Sync" Off: 0...127 / "Bpm Sync" On: 1/64, 1/32, 1/24, 1/16, 1/12, 3/32, 1/8, 1/6, 3/16, 1/4, 1/3, 3/8, 1/2, 3/4, 1/1] (CC#13)

Sets the amount of time the input signal will be delayed before being output. Turning the knob to the right will increase the delay time.

#### 4. Depth [0...127] (CC#113)

Sets the input level of the delay, affecting how intense the effect is. Turning the knob to the right increases the input level.

**5. Low Cut** [0...127] (CC#114)

Adjusts the cutoff frequency of the high-pass filter. Sounds and harmonic components below the cutoff frequency will be attenuated. Turning the knob to the right will increase the cutoff frequency.

**DELAY EXTRA**

**2. BPM Sync (BpmSync)** [Off / On]

Toggles the delay time parameter between absolute time (milliseconds) and tempo synced subdivisions.

**3. LR Offset (Offset)** [-63...0...63]

Applies a delay offset between the left and right delay channels, creating a wider stereo image. Turning the knob right of center increases the right delay time relative to the left, and turning the knob left of center increases the left delay time relative to the right.

**4. Feedback** [0...127]

Sets the amount of delay output that is added back into the input. Turning the knob to the right will increase the number of repeats.

**5. Dry/Wet** [0...100 %]

Adjusts the mix of the dry and wet signals relative to each other. Turning the knob to the right will decrease the input signal mix and increase the delay output mix.

# REVERB

The reverb effect is used to create the impression of playing in a space. This effect is produced by combining the sound of multiple sonic reflections that occur at different times.

- Press the REVERB button while holding down the ON/OFF button to turn the effect on/off (the LED below the button lights up when the effect is on).
- Press the REVERB button to access the related parameters (the button blinks). Use the EDIT CONTROL 1-5 knobs and the FUNCTION 1, 2 buttons to set the value.
- Long-press either the MOD, DELAY or REVERB button to access the EFFECT ROUTING page, where you can set the effect to which each timbre and the mic audio is sent. → [EFFECT ROUTING](#)
- Use the Effect Type parameter (knob 1) to select the effect type. The parameters shown below (knobs 2-5) depend on the effect type.

## REVERB



### 1. Effect Type (Type) [Hall, Room, Spring, Rust, Pitch Shift, LoRes]

Selects the effect type.

### 2...5. Effect Parameters

This configures the parameters of each effect.

For more on the parameters, refer to the explanations for each effect type.

## REVERB DETAILS

### 1...5. Effect Parameters

This configures the parameters of each effect.

For more on the parameters, refer to the explanations for each effect type.

## | Effect Type

### Hall

A reverb that imitates the ambience of a hall.

### Room

A reverb that imitates the ambience of a room.

### Spring

An algorithm that imitates a reverb made with a metal spring.

### Rust

A unique, lo-fi reverb.

### Pitch Shift

A reverb that shifts the reverberating signal up or down an octave.

### LoRes

A reverb that reduces the sample rate of the reverberating signal.

#### 1. Effect Type (Type) Hall/Room/Spring/Rust/Pitch Shift/LoRes

#### 2. Depends on the Effect Type setting

**Hall:** N/A (---)

**Room:** N/A (---)

**Spring:** N/A (---)

**Rust: Age** [0...127] (CC#118)

Adjusts the amount of modulation and processing done in the reverb. Turning the knob to the right increases the intensity.

**Pitch Shift: Shift mix (Shift)** [-63...63] (CC#118)

Adjusts the mix of pitch shifted signal in the output and feedback network of the reverb. Turning the knob to the right of center shifts the reverb signal up by an octave and increases the mix relative to the unshifted signal, and turning the knob to the left of center shifts the reverb signal down by an octave and increases the mix relative to the unshifted signal.

**LoRes: Reduction (Reduct)** [0...127] (CC#118)

Adjusts the sample rate of the reverb. Turning the knob to the right reduces the sample rate.

#### 3. Time [0...127] (CC#14)

Sets the amount of time the reverberating signal is audible. Turning the knob to the right increases the duration.

#### 4. Depth [0...127] (CC#116)

Sets the input trim of the effect, in turn affecting the decay time and output level. Turning the knob to the right increases the input level.

**5. Damping (Damp) [0...127] (CC#117)**

Sets the cutoff frequency of the damping filter. Turning the knob to the right reduces the amount of high frequency content.

**REVERB EXTRA**

**2. PreDelay [0...127]**

Sets the amount of time between the reverb receiving a signal and producing an output signal. Turning the knob to the right increases the delay between input and output.

**3. Width [0...127]**

Adjusts the stereo image of the reverb. Turning the knob to the right creates a wider stereo image.

**4. Size [0...127]**

Changes the internal delay times to create the impression of different sized spaces. Turning the knob to the right will increase the perceived size of the space.

**5. Dry/Wet [0...100 %]**

Adjusts the mix of the dry and wet signals relative to each other. Turning the knob to the right will decrease the input signal mix and increase the reverb output mix.

# EFFECT ROUTING

- Long-press either the MOD, DELAY or REVERB button to access the EFFECT ROUTING page.

## EFFECT ROUTING



The effects are connected in series, in the following order: modulation effect (MOD) → delay effect (DELAY) → reverb effect (REVERB). The EQ is connected last.

Use this to configure where the audio signals from each timbre and mic are connected to the effects in the signal chain.

### 1. Timbre 1 Routing (Timbre 1) [Mod, Delay, Reverb, Bypass]

Sets where the output of timbre 1 is connected in the effect signal chain.

**Mod:** The signal is input before the Mod effect. As a result, effects from Mod onward are applied to the signal.

**Delay:** The signal is input before the Delay effect. As a result, effects from Delay onward are applied to the signal.

**Reverb:** The signal is input before the Reverb effect. As a result, only the reverb is applied to the signal.

**Bypass:** The signal is not routed through any effects.

### 2. Timbre 2 Routing (Timbre 2) [Mod, Delay, Reverb, Bypass]

Sets where the output of timbre 2 is connected in the effect signal chain.

See "Timbre 1 Routing".

### 3. Mic Routing (Mic) [Mod, Delay, Reverb, Bypass]

Sets where the audio signal input from the MIC jack is connected in the effect signal chain.

See "Timbre 1 Routing".

# EQ

## EQ

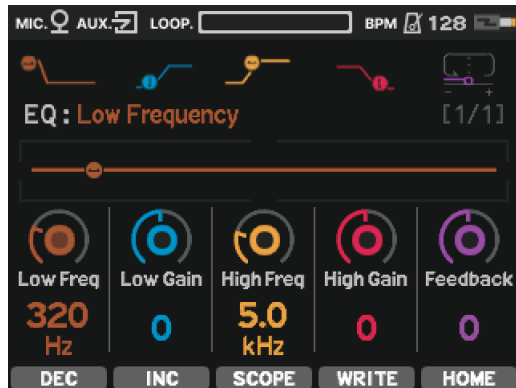

The output from the effects is routed through the equalizer (EQ), the last stage in the effect signal chain for adjusting the tonal character.

The EQ is used to adjust the tonal balance, such as by bringing muddy sounds forward in the mix or by toning down sounds that stand out too much.

- Press the EQ button while holding down the ON/OFF button to turn the equalizer on/off (the LED below the button lights up when the equalizer is on).
- Use the Frequency (knobs 1 and 3) to set the frequencies to adjust, and use the Gain (knobs 2 and 4) to set the gain for each frequency.

*Note:* Excessively raising the equalizer gain may make the output sound distorted.

### 1. Low Frequency (Low Freq) [40...1000 Hz] (CC#95)

Sets the frequency of the low-range equalizer.

### 2. Low Gain [-63...0...63] (CC#110)

Sets the amount of boost or cut for the low-range equalizer.

### 3. High Frequency (High Freq) [1.0...18.0 kHz] (CC#94)

Sets the frequency of the high-range equalizer.

### 4. High Gain [-63...0...63] (CC#109)

Sets the amount of boost or cut for the high-range equalizer.

### 5. Output Feedback (Feedback) [-63...0...63] (CC#93)

Sets how much of the output from the EQ you want to feed back into the EQ input. A negative value inverts the phase of the signal that's fed back.



## LOOP RECORDER section

---

→ [LOOP RECORDER](#)

→ [LOOP SETTING A](#)

→ [LOOP SETTING B](#)

# LOOP RECORDER

---

The loop recorder is used to record and play back the microKORG2's audio, as well as audio from a mic or from the AUX IN.

## | REC, PLAY/STOP

When the loop recorder is stopped, press the **O** button to enter record standby and the **▷/□** button to start recording. Also, when the loop recorder is stopped, press the **▷/□** button to begin playback and the **O** button to start recording.

You can also long-press the **O** or **▷/□** buttons to access the LOOP SETTING A/B pages, which contain the loop recording and playback settings.

## | Undo/Redo

Press the **↶** button to undo or redo an operation. This lets you undo the previous recording.

Long-press the **↶** button to erase the audio data.

# LOOP SETTING A

Use these settings to configure the record settings for the loop recorder.

- Long-press the **O** button to access the LOOP SETTING A page.

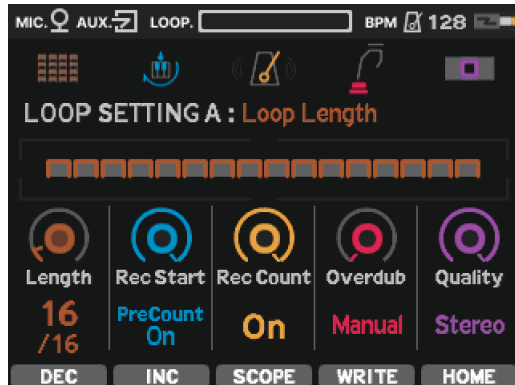

## 1. Loop Length (Length) [1/16...16/16, 24/16, 32/16, 48/16, 64/16, 96/16, 128/16]

Specifies the length of the loop that's to be recorded to the loop recorder.

*Note:* The values shown above are the steps available when turning the knob. To set the loop length to a value in between those shown above, press the FUNCTION 1, 2 (DEC, INC) buttons.

*Note:* The maximum loop length depends on the Tempo and Recording Quality settings. When Recording Quality is set to "Stereo Lo-Q", a Tempo setting of "30" results in a loop length of "128/16".

## 2. Recording Start (Rec Start) [Keyboard Trigger, PreCount Off, PreCount On]

These settings apply when recording begins, from the time the loop recorder enters record standby mode.

**Keyboard Trigger:** Recording begins when you press a key.

**PreCount Off:** The pre-count (click sound) is not played, and recording begins right away.

**PreCount On:** Recording begins after the pre-count (click sound).

## 3. Recording Count (Rec Count) [Off, On]

Sets whether to play the count (click sound) in time with the tempo during recording.

## 4. Overdub Mode (Overdub) [Manual, Loop]

Sets when recording will start in relation to the loop playback position. This only affects how the looper behaves when it is already playing.

**Manual:** The looper will begin recording immediately when the record state is triggered, as determined by the Rec Start parameter.

**Loop:** Recording will begin at the beginning of the next loop.

## 5. Recording Quality (Quality) [Mono Lo-Q, Stereo Lo-Q, Mono, Stereo]

This sets the sound quality used for the recorded data.

**Mono Lo-Q:** The sound is recorded using monaural data.

**Stereo Lo-Q:** The sound is recorded using stereo data.

**Mono:** The sound is recorded using high-quality monaural data.

**Stereo:** The sound is recorded using high-quality stereo data.

## LOOP SETTING B

These are the loop recorder playback-related settings.

- Long-press the ▶/□ button to access the LOOP SETTING B page.



### 1. Stutter [Off, On Forward, On Reverse] (NRPN 8, 16)

The stutter function is used to repeatedly play back parts of short loops.

This parameter sets whether to enable the stutter function, playing back the loop at the length set in "Stutter Length".

*Note:* This is set to "Off" when you stop playback, start recording, or clear the loop data.

**Off:** Disables the stutter function.

**On Forward:** Enables the stutter function.

**On Reverse:** Plays back the stutter in reverse.

### 2. Stutter Length (St.Length) [1/1, 1/2, 1/4, 1/6, 1/8, 1/12, 1/16, 1/24, 1/32, 1/64, 1/128] (NRPN 8, 17)

Sets the stutter playback length.

### 3: Stutter Offset (St.Offset) [-63...0...63] (NRPN 8, 18)

You can shift the loop point of the stutter up to one measure.

*Note:* When Stutter is set to "Off", this is reset to zero and you cannot change the value.

### 4. Count Level (Count Lvl) [0...127]

Sets the volume of the click that's heard during the pre-count and when recording.

### 5. Loop Play Level (Play Lvl) [0...127] (NRPN 8, 19)

Sets the volume of the loop that's played back by the loop recorder.

# Functions

---

Press buttons 1-4 while holding down the FUNC (FUNCTION 5) button to access the functions from INITIALIZE to TROPHY.

→ [Initializing the programs and timbres \(INIT\)](#)

→ [Copying programs and timbres \(COPY\)](#)

→ [Manual / GUI Design](#)

→ [TROPHY](#)

# INITIALIZE (INIT), COPY, MANUAL, TROPHY

---

## | Initializing the programs and timbres (INIT)

- 1 Select a program to initialize.
- 2 Press the INIT (FUNCTION 1) button while holding down the FUNC (FUNCTION 5) button.
- 3 Turn the EDIT CONTROL knob 1 or press the INC, DEC buttons (FUNCTION 2, 1 button) to select what to initialize.
- 4 Press the EXECUTE (FUNCTION 4) button to initialize. Press the CANCEL (FUNCTION 5) button to cancel.

### **Initialize Target**      [PROGRAM, TIMBRE 1, TIMBRE 2]

Sets what part of the program to initialize.

*Note:* Initializing does not overwrite the data stored in the microKORG2's memory– you must write the program to memory if you want to save its initialized state.

## | Copying programs and timbres (COPY)

- 1 Select the copy destination program.
- 2 Press the COPY (FUNCTION 2) button while holding down the FUNC (FUNCTION 5) button.
- 3 Use the EDIT CONTROL 1-4 knob or the INC, DEC buttons (FUNCTION 2, 1 buttons) to select the copy source program item or the copy destination timbre.
- 4 Press the EXECUTE (FUNCTION 4) button to execute the copy operation. Press the CANCEL (FUNCTION 5) button to cancel.

### **Source Program**      [CLASSIC A1...USER H8]

Select a program from which you want to copy the settings to the current program.

### **Module**      [ALL, TIMBRE 1, TIMBRE 2, ASSIGN, ARP, PATCH, VOCAL PROCESSOR, EFFECT, EQ]

Select the program item to copy.

### **Timbre Parts**      [ALL, VOICE, PITCH, ...PATCH ALL]

When Module is set to “TIMBRE 1” or “TIMBRE 2”: Select the items to copy from the specified timbre.

### **Target Timbre**      [TIMBRE 1, 2]

When Module is set to “TIMBRE 1” or “TIMBRE 2”: Select the copy destination timbre.

### **Patch Parts**      [TIMBRE 1 PATCH 1...TIMBRE 2 PATCH 6]

When Module is set to “PATCH”: Select the patch to copy.

### **Target Patch**      [TIMBRE 1 PATCH 1...TIMBRE 2 PATCH 6]

When Module is set to “PATCH”: Select the copy destination patch.

### **Vocal Parts**      [VOCAL ALL ...HARMONIZER]

When Module is set to “VOCAL PROCESSOR”: Select the items to copy.

**Effect Parts**                    **[EFFECT ALL ... REVERB]**

When Module is set to “**EFFECT**”: Select the items to copy.

*Note:* Copying data does not overwrite the data stored in the microKORG2's memory– you must write the program to memory if you want to save its edited state resulting from the copy operation.

## | **Manual / GUI Design**

To view the system version, credits, and the QR code that lets you access the HTML version of the Owner's Manual, please do the following.

- 1** Press the MANUAL (FUNCTION 3) button while holding down the FUNC (FUNCTION 5) button.
- 2** Press the CUR <, CUR > button (FUNCTION 2 button) to switch between pages.
- 3** Use your smartphone or other device to scan the 2D code that lets you view the HTML Owner's Manual.

## | **TROPHY**

To celebrate you exploring the functionality of the microKORG2, the trophies on this page will turn colorful after being unlocked. To see a description of what you did to earn the trophy, select it with the INC and DEC buttons (FUNCTION 1, 2) and press the INFO button (FUNCTION 3). Try collecting all of the trophies!

# Appendices

---

- [Troubleshooting](#)
- [Backing up your data](#)
- [Updating the system](#)
- [Restoring the factory settings](#)



# Troubleshooting

---

Please check the following points if you experience problems.

## Power does not turn on

- Is the AC adapter plugged into the AC outlet?
- If you are using batteries, are the batteries installed correctly, and are they still holding a charge?

## No sound

- Have you correctly connected the jacks of this keyboard to your powered monitor amp or headphones?
- Is the powered monitor amp or similar equipment to which the keyboard is connected turned on, and is the volume turned up so that you can hear it?
- Is the VOLUME knob set to a level at which you can hear the sound?
- Is the Local Control (LocalCtrl) setting on the MIDI page set to "ON"?
- Make sure that the parameters related to volume are not set to "0".
- If the FILTER Type is set to "LP", make sure that the Cutoff parameter is not set to "0".
- Check whether the Env Follower Sens (E.F.Sens) parameter is not set to "HOLD" even though there is no input from the MIC IN CONDENSER or DYNAMIC jacks.

## Cannot input sound

- Have you connected a mic to the MIC IN CONDENSER or MIC IN DYNAMIC jack?
- Have you connected an input source to the AUX IN jack?
- If you've connected a mic to the MIC IN CONDENSER or MIC IN DYNAMIC jack, make sure the MIC knob level is not at the minimum setting.
- Is the audio that you want to use as a modulator for the vocoder being input to the mic that's connected to the MIC IN CONDENSER or DYNAMIC jack?
- Note that if you've connected a mic to both the MIC IN CONDENSER and DYNAMIC jacks, the audio input from the CONDENSER jack takes priority and the input from the DYNAMIC jack is disabled.

## Mic input sound is distorting

- Use the MIC knob to adjust the volume of the sound after digital signal processing. If the sound is distorted, try vocalizing softer or adjust your distance from the mic, so that the sound doesn't distort.

## Sounds cannot be edited

- If you can't edit timbre 2 for a program, make sure that Timbre Mode (Timb Mode) in VOICE is not set to "Dual".
- If you can't edit either timbre 1 or 2 for a program, check whether the TIMBRE 1/2 LEDs for the timbre you want to edit are lit up.
- If the program you want to edit is no longer available, you might have turned the power off before writing the program to memory. Note that the edited program settings are discarded when you select another program. Write your edited program to save its settings before turning off the power or switching programs.

## Arpeggiator doesn't start playing

- Is the arpeggiator on? (The LED of the ON button should be lit.)
- Is the Clock Source (ClockSrc) setting on the MIDI page set correctly?

**The microKORG2 is not responding to MIDI data sent from an external device**

- Are the MIDI cables connected correctly?
- Are the MIDI channels of the external MIDI device that is transmitting the data and of the microKORG2 the same?
- Are the MIDI Filter parameters set to "Enable"?

**Can't control the two timbres using separate MIDI channels**

- Are the MIDI "Global Ch" and "Timb2 Ch" set to different channels?

## Backing up your data

---

Use USB mass storage mode along with your computer to back up the programs and global data of this instrument.

### | Backing up the programs and global data

- 1 Connect the USB port on the microKORG2 to your computer with a USB cable.
- 2 Press the power button while holding down the FUNCTION 1 button to start up in USB mass storage mode.  
The "microkorg2" USB drive is shown on your computer, which contains a "Programs" folder and a "Global" folder.
- 3 Copy the program data (.mk2prog) and the global data (.mk2glob) from the respective folders to your computer to back up the data.
- 4 Press the FUNCTION 5 button to exit USB mass storage mode.  
The microKORG2 restarts automatically.

*Note:* If you're connected to a Mac, first eject the "microkorg2" USB drive on your Mac and then perform the operations on the microKORG2.

### | Loading programs and global data

- 1 Start the instrument in USB mass storage mode.  
See steps 1 and 2 above for details.
- 2 Copy the backup program data (.mk2prog) and global data (.mk2glob) to their respective folders.
- 3 Press the FUNCTION 5 button to exit USB mass storage mode.  
The microKORG2 restarts automatically. Now you can use the data you've copied.

.mk2prog prefix

BANK	GENRE	NO.	Prefix
CLASSIC	A: POP/ ROCK	1 ... 8	C_A1_ ... C_A8_
	B: FUNK/SOUL	1 ... 8	C_B1_ ... C_B8_
	C: HIPHOP/R&B	1 ... 8	C_C1_ ... C_C8_
	D: HOUSE/DISCO	1 ... 8	C_D1_ ... C_D8_
	E: AMBIENT/ELECTRONICA	1 ... 8	C_E1_ ... C_E8_
	F: TECHNO/TRANCE	1 ... 8	C_F1_ ... C_F8_
	G: DNB/DUBSTEP	1 ... 8	C_G1_ ... C_G8_
	H: GAME/SFX	1 ... 8	C_H1_ ... C_H8_
MODERN	A: POP/ ROCK	1 ... 8	M_A1_ ... M_A8_
	B: FUNK/SOUL	1 ... 8	M_B1_ ... M_B8_
	C: HIPHOP/R&B	1 ... 8	M_C1_ ... M_C8_
	D: HOUSE/DISCO	1 ... 8	M_D1_ ... M_D8_
	E: AMBIENT/ELECTRONICA	1 ... 8	M_E1_ ... C_E8_
	F: TECHNO/TRANCE	1 ... 8	M_F1_ ... M_F8_
	G: DNB/DUBSTEP	1 ... 8	M_G1_ ... M_G8_
	H: GAME/SFX	1 ... 8	M_H1_ ... M_H8_
FUTURE	A: POP/ ROCK	1 ... 8	F_A1_ ... F_A8_
	B: FUNK/SOUL	1 ... 8	F_B1_ ... F_B8_
	C: HIPHOP/R&B	1 ... 8	F_C1_ ... F_C8_
	D: HOUSE/DISCO	1 ... 8	F_D1_ ... F_D8_
	E: AMBIENT/ELECTRONICA	1 ... 8	F_E1_ ... F_E8_
	F: TECHNO/TRANCE	1 ... 8	F_F1_ ... F_F8_
	G: DNB/DUBSTEP	1 ... 8	F_G1_ ... F_G8_
	H: GAME/SFX	1 ... 8	F_H1_ ... F_H8_
USER	A: POP/ROCK	1 ... 8	U_A1_ ... U_A8_
	⋮	⋮	⋮
	H: GAME/SFX	1 ... 8	U_H8_ ... F_H8_

## Updating the system

---

- 1 Download the latest software from the [https://www.korg.com/microkorg2\\_driver/](https://www.korg.com/microkorg2_driver/) website.
- 2 Connect the USB port on the microKORG2 to your computer with a USB cable.
- 3 Press the power button while pressing the FUNCTION 3 button on the microKORG2.
- 4 Copy the update file that you downloaded from the KORG website to the "UPDATE" folder on the USB drive that's shown on your computer.

*Note:* If you're connected to a Mac, first eject the "microkorg2" USB drive on your Mac and then perform the operations on the microKORG2.

- 5 Press the FUNCTION 4 button to update the system.
- 6 Once the message "COMPLETE: PLEASE REBOOT" appears, long-press the power button to turn off the power, and press it again to restart the instrument.

# Restoring the factory settings

This shows you how to restore the program and global data settings on the microKORG2 to their default values (factory reset).

- ⚠ Once you've performed a factory reset, any existing data on the microKORG2 is overwritten with the factory default settings. Check whether it's all right to overwrite the data before you do this.
- ⚠ Don't touch the knobs, the keyboard or any other controls on this instrument while the data is being reset. Never turn off the power while the factory reset is in progress.

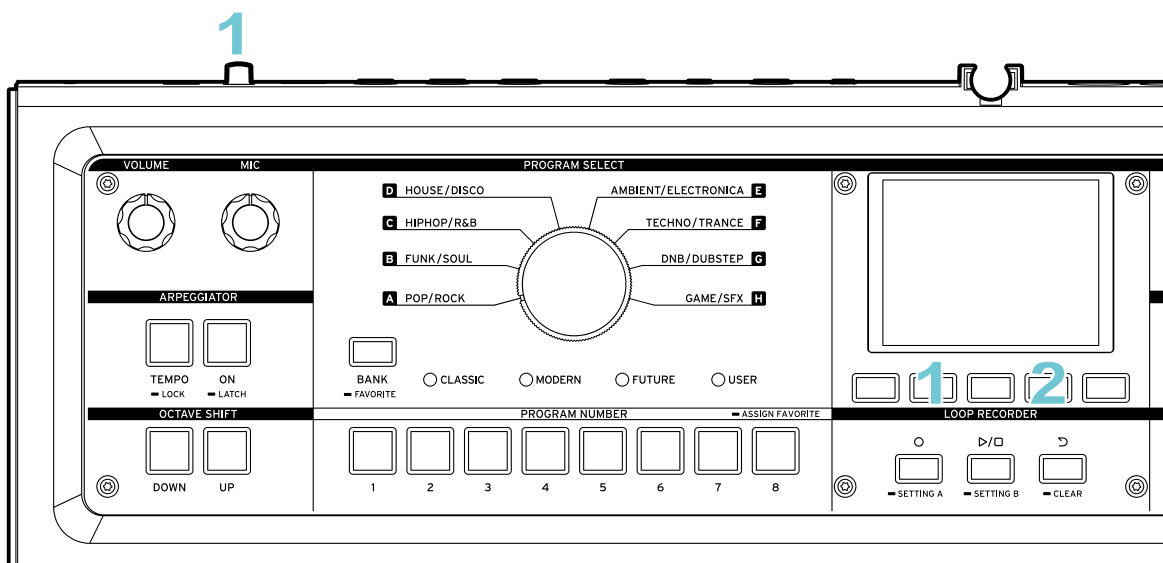

- 1 Press the power button while holding down the FUNCTION 2 button. "FACTORY RESET" is shown.
  - 2 Press the buttons corresponding to the items you want to initialize, and perform the reset.
    - FUNCTION 1 (PROGs) button:** resets all program settings
    - FUNCTION 2 (GLOBAL) button:** resets the global settings
    - FUNCTION 3 (LOOP REC) button:** resets the loop recorder settings
    - FUNCTION 4 button (ALL):** resets all settings
    - FUNCTION 5 button (CANCEL):** cancels the factory reset
- The instrument starts up normally once the reset is completed.

# OSC 1-3 Wave List

## DWGS

No.	Category	Name	No.	Category	Name	No.	Category	Name
0	SynSine	SynSine 1	23	LoRes	LoRes Pulse 12	47	Bell	Bell 1
1		SynSine 2	24		LoRes Pulse 25	48		Bell 2
2		SynSine 3	25		LoRes Square	49		Bell 3
3		SynSine 4	26		LoRes Triangle	50		Bell 4
4		SynSine 5	27	Digi	Digi 1	51		Bell 5
5		SynSine 6	28		Digi 2	52	SynVox	SynVox 1
6		SynSine 7	29		Digi 3	53		SynVox 2
7		SynWave 1	30		Digi 4	54		SynVox 3
8		SynWave 2	31		Digi 5	55		SynVox 4
9		SynWave 3	32		Digi 6	56		SynVox 5
10		SynWave 4	33		Digi 7	57		SynVox 6
11		SynWave 5	34		Digi 8	58		SynVox 7
12		SynWave 6	35	Inst	Inst EP 1	59		SynVox 8
13		SynWave 7	36		Inst EP 2	60	Airy	Airy 1
14	SynWave 8	37	Inst EP 3		61	Airy 2		
15	Oct	Oct Saw	38		Inst Organ 1	62		Airy 3
16		Oct Pulse	39		Inst Organ 2	63		Airy 4
17		Oct Square	40		Inst Organ 3			
18		Oct Phat	41		Inst Clav			
19	5th	5th Saw	42		Inst Guitar			
20		5th Square	43	Bass	Bass 1			
21		5th Sine	44		Bass 2			
22		5th Wide	45		Bass 3			
		46	Bass 4					

## Oneshot

No.	Category	Name	No.	Category	Name	
0	Click	Click Tight	16	Metallic	Metallic Coin	
1		Click Round	17		Metallic Pipe	
2		Click Grazing	18		Metallic Stick	
3		Click Techy	19		Metallic Plate	
4		Click Husky	20		Metallic Mute	
5		Click Weak	21		Metallic Bowl	
6	Perc	Perc Kick	22		Metallic Bell	
7		Perc Slap	23		Metallic Blade	
8		Perc Block	24		Decay	Decay Shot
9		Perc Hihat	25			Decay Brush
10		Perc Claves	26	Decay Filter		
11	Perc Guiro	27	Decay Motion			
12	Foley	Foley TinCan	28	Decay Zap		
13		Foley Lute	29	Decay Notice		
14		Foley Rainstick	30	Decay Blip		
15		Foley IceDrop	31	Decay Fall		

# Performance Edit List

This is a list of parameters assigned to the five EDIT CONTROL knobs using TIMBRE EDIT ASSIGN.

No.	Parameter	No.	Parameter	No.	Parameter
0	NoAssign	47	Timbre1 Patch1 Int	94	Timbre2 FltEG Int
1	Timbre1 Unison Detune	48	Timbre1 Patch2 Int	95	Timbre2 LFO1 Freq
2	Timbre1 Unison Spread	49	Timbre1 Patch3 Int	96	Timbre2 LFO1 Smooth
3	Timbre1 Porta Time	50	Timbre1 Patch4 Int	97	Timbre2 LFO2 Freq
4	Timbre1 Trans	51	Timbre1 Patch5 Int	98	Timbre2 LFO2 Delay
5	Timbre1 FineTune	52	Timbre1 Patch6 Int	99	Timbre2 Patch1 Int
6	Timbre1 Level	53	Timbre2 Unison Detune	100	Timbre2 Patch2 Int
7	Timbre1 Pan	54	Timbre2 Unison Spread	101	Timbre2 Patch3 Int
8	Timbre1 OSC1 Wave	55	Timbre2 Porta Time	102	Timbre2 Patch4 Int
9	Timbre1 OSC1 Shape	56	Timbre2 Trans	103	Timbre2 Patch5 Int
10	Timbre1 OSC1 OSC Mod	57	Timbre2 FineTune	104	Timbre2 Patch6 Int
11	Timbre1 OSC1 Semitone	58	Timbre2 Level	105	Tempo
12	Timbre1 OSC1 FineTune	59	Timbre2 Pan	106	Arp Swing
13	Timbre1 OSC1 Level	60	Timbre2 OSC1 Wave	107	Arp Reso
14	Timbre1 OSC2 Wave	61	Timbre2 OSC1 Shape	108	Arp Type
15	Timbre1 OSC2 Shape	62	Timbre2 OSC1 OSC Mod	109	Arp Octave
16	Timbre1 OSC2 OSC Mod	63	Timbre2 OSC1 Semitone	110	Arp Gate
17	Timbre1 OSC2 Semitone	64	Timbre2 OSC1 FineTune	111	Arp Step
18	Timbre1 OSC2 FineTune	65	Timbre2 OSC1 Level	112	Vocal Vocoder Direct
19	Timbre1 OSC2 Level	66	Timbre2 OSC2 Wave	113	Vocal Vocoder Synth
20	Timbre1 OSC3 Wave	67	Timbre2 OSC2 Shape	114	Vocal Vocoder Formant
21	Timbre1 OSC3 Shape	68	Timbre2 OSC2 OSC Mod	115	Vocal Vocoder Reso
22	Timbre1 OSC3 Semitone	69	Timbre2 OSC2 Semitone	116	Vocal Vocoder Sens
23	Timbre1 OSC3 FineTune	70	Timbre2 OSC2 FineTune	117	Vocal Hardtune Int
24	Timbre1 OSC3 Level	71	Timbre2 OSC2 Level	118	Vocal Hardtune Speed
25	Timbre1 Noise Type	72	Timbre2 OSC3 Wave	119	Vocal Hardtune Formant
26	Timbre1 Noise Color	73	Timbre2 OSC3 Shape	120	Vocal Harmo Level
27	Timbre1 Noise Level	74	Timbre2 OSC3 Semitone	121	Vocal Harmo Stereo
28	Timbre1 Filter Type	75	Timbre2 OSC3 FineTune	122	Vocal Harmo Formant
29	Timbre1 Filter Cutoff	76	Timbre2 OSC3 Level	123	Vocal Harmo Detune
30	Timbre1 Filter Reso	77	Timbre2 Noise Type	124	Vocal Harmo Delay
31	Timbre1 Filter Drive	78	Timbre2 Noise Color	125	Vocal Harmo Pitch1
32	Timbre1 Filter Keytrack	79	Timbre2 Noise Level	126	Vocal Harmo Pitch2
33	Timbre1 AmpEG Attack	80	Timbre2 Filter Type	127	Effect Mod Param1
34	Timbre1 AmpEG Decay	81	Timbre2 Filter Cutoff	128	Effect Mod Param2
35	Timbre1 AmpEG Sustain	82	Timbre2 Filter Reso	129	Effect Mod Param3
36	Timbre1 AmpEG Release	83	Timbre2 Filter Drive	130	Effect Delay Param1
37	Timbre1 AmpEG VeloSens	84	Timbre2 Filter Keytrack	131	Effect Delay Param2
38	Timbre1 FltEG Attack	85	Timbre2 AmpEG Attack	132	Effect Delay Param3
39	Timbre1 FltEG Decay	86	Timbre2 AmpEG Decay	133	Effect Delay Param4
40	Timbre1 FltEG Sustain	87	Timbre2 AmpEG Sustain	134	Effect Reverb Param1
41	Timbre1 FltEG Release	88	Timbre2 AmpEG Release	135	Effect Reverb Param2
42	Timbre1 FltEG Int	89	Timbre2 AmpEG VeloSens	136	Effect Reverb Param3
43	Timbre1 LFO1 Freq	90	Timbre2 FltEG Attack	137	Effect Reverb Param4
44	Timbre1 LFO1 Smooth	91	Timbre2 FltEG Decay	138	LoopRec Stutter
45	Timbre1 LFO2 Freq	92	Timbre2 FltEG Sustain	139	LoopRec Stutter Length
46	Timbre1 LFO2 Delay	93	Timbre2 FltEG Release	140	LoopRec Stutter Offset



# PATCH 1-6 List

## Source 1, 2

No.	Parameter
0	NoAssign
1	Velocity (+), Velocity (+-)
2	KbdTrk (+), KbdTrk (+-)
3	Pitch Bend
4	Mod.W (+), Mod.W (+-)
5	Flt EG (+), Flt EG (+-)
6	Amp EG (+), Amp EG (+-)
7	LFO1 (+), LFO1 (+-)
8	LFO2 (+), LFO2 (+-)
9	Noise
10	Analog

## Destination

No.	Parameter	No.	Parameter	No.	Parameter
0	NoAssign	26	AMP EG Sustain	52	H.TUNE Formant
1	Unison Detune	27	AMP EG Release	53	HARMONY HarmoLvl
2	Unison Spread	28	AMP EG Dcy&Rls	54	HARMONY Stereo
3	TIMBRE P.Time	29	FLT EG Attack	55	HARMONY Formant
4	TIMBRE Pitch	30	FLT EG Decay	56	HARMONY Detune
5	TIMBRE Level	31	FLT EG Sustain	57	HARMONY Delay
6	TIMBRE Pan	32	FLT EG Release	58	HARMONY Pitch1
7	OSC1 Shape	33	FLT EG Dcy&Rls	59	HARMONY Pitch2
8	OSC1 OSC Mod	34	FLT EG Int	60	MOD (Param1)
9	OSC1 Pitch	35	LFO1 Freq	61	MOD (Param2)
10	OSC1 Level	36	LFO1 Smooth	62	MOD (Param3)
11	OSC2 Shape	37	LFO2 Freq	63	DELAY (Param1)
12	OSC2 OSC Mod	38	LFO2 Delay	64	DELAY (Param2)
13	OSC2 Pitch	39	ARP Swing	65	DELAY (Param3)
14	OSC2 Level	40	ARP Reso	66	DELAY (Param4)
15	OSC3 Shape	41	ARP Type	67	REVERB (Param1)
16	OSC3 Pitch	42	ARP Octave	68	REVERB (Param2)
17	OSC3 Level	43	ARP Gate	69	REVERB (Param3)
18	NOISE Color	44	ARP Steps	70	REVERB (Param4)
19	NOISE Level	45	VOCODER Mic	71	EQ LowFreq
20	FILTER Type	46	VOCODER Synth	72	EQ Low Gain
21	FILTER Cutoff	47	VOCODER Formant	73	EQ High Freq
22	FILTER Reso	48	VOCODER Reso	74	EQ High Gain
23	FILTER Drive	49	VOCODER Sens	75	EQ Feedback
24	AMP EG Attack	50	H.TUNE Int		
25	AMP EG Decay	51	H.TUNE Speed		

# Specifications

---

## Keyboard

37 keys (mini keyboard, velocity sensitive)

## Sound generation system

Analog modeling synthesis system

## Timbres

Max. of 2 (in Dual mode)

## Maximum polyphony

Synthesizer 8 voices, Vocoder 4 voices, Hard Tune 1 part, Harmonizer 2 parts

## Structure

### Oscillators and noise generator

Sawtooth wave, square wave, triangle wave, sine wave (PWM function), DWGS x 64, One Shot x 32, Noise

Oscillator modulation function (Ring, Sync, Ring + Sync, VPM)

### Filter

-24 dB/oct LPF, -12 dB/oct LPF, -12 dB/oct BPF, -12 dB/oct HPF (morphing function)

### EG

Filter EG, amp EG

### LFO

LFO1, LFO2 (five LFO waves; can be synchronized to the arpeggiator or to external MIDI clocks)

### Virtual patches

6

### Vocal processors

**Vocoder:** 16-channel vocoder with variable level/panpot for each channel, formant shift function

#### Hard Tune

#### Harmonizer

### Effects, EQ

**MOD** (modulation): 9 types including Chorus, Flanger, Ensemble, Phaser, Tremolo, LoFi, Comp, Distortion and Amp Simulator

**DELAY:** 6 types including Stereo, Ping Pong, Tape Echo, Pitch Shift, Reverse, LoRes

**REVERB:** 6 types including Hall, Room, Spring, Rust, Pitch Shift, LoRes

**EQ:** 2-band equalizer

## Arpeggiator

UP, DOWN, UP-DOWN, DOWN-UP, Converge, Diverge, Manual, Random 1/2, Trigger (10 types), step arpeggiator function

## Programs

256 (4 banks x 8 genres x 8 programs)

## Loop recorder

Approx. 43 sec. (32-bit floating point, stereo)

## Input/output jacks

OUTPUT - L/MONO, R jacks (6.3 mm TS phone jack, unbalanced)

Headphones jack (6.3 mm TRS phone jack, unbalanced)

MIC IN - CONDENSER jack (+5 V 3.5 mm TRS mini phone jack, unbalanced)

MIC IN - DYNAMIC jack (6.3 mm TS phone jack, unbalanced)

AUX IN jack (3.5 mm TRS mini phone jack, unbalanced)

DAMPER/SWITCH jack (6.3 mm TS phone jack)

MIDI IN, OUT connectors

USB Type-C port

## Display

2.8-inch TFT IPS LCD

## Power supply

When using an AC adapter: DC 9 V AC adapter (included)

When using batteries: six AA batteries (alkaline or nickel-metal hydride)

## Battery life

Approx. 4 hours or more (when using alkaline batteries)

## Dimensions (W x D x H)

542 x 238 x 65 mm (21.34" x 9.37" x 2.56")

## Weight

**MK-2:** 2.2 kg/4.85 lb, **MK-2 MBK/MWH:** 2.1 kg/4.63 lb (without batteries and included microphone)

## Included items

Condenser mic, AC adapter (DC 9 V), Precautions/Quick Start Guide

## Accessories (sold separately)

DS-1H damper pedal, PS-1 or PS-3 pedal switch

\*Specifications and appearance are subject to change without notice for improvement.

\*The GUI design of this instrument was developed in collaboration with BLINKSONIC®.



\*All product names and company names are the trademarks or registered trademarks of their respective owners.

## **Operating requirements (for USB connection)**

---

See the Korg website for the latest information on OS support.

<https://www.korg.com/support/os/>

# MIDI Implementation Chart

[SYNTHESIZER/VOCODER]

Date: 2024.5.15

Model: microKORG 2

## MIDI Implementation Chart

Ver.: 1.00

Function...		Transmitted	Recognized	Remarks
Basic Channel	Default	1-16	1-16	Memorized
	Change	1-16	1-16	
Mode	Default	X	3	
	Messages	X	X	
	Altered	*****		
Note Number		0-127	0-127	
	True Voice	*****	0-127	
Velocity	Note On	O 9n, V=1-127	O 9n, V=1-127	
	Note Off	X 8n, V=64	X	
After Touch	Key's	X	X	
	Channel	X	X	
Pitch Bend		O	O	*B
Control Change	0, 32	O	O	Bank select (MSB, LSB) °P
	1	O	O	Modulation wheel °C
	6, 38	O	O	Data entry (MSB, LSB) °C
	7, 10	O	O	Timbre Level °C
	64	O	O	Damper pedal °C
	5, 65	O	O	Portamento Time, Mode °C
	33, 34, 35, 36	O	O	Unison Detune, Spread, Transpose, Fine Tune °C
	8, 9, 15, 16, 17, 23	O	O	Oscillator 1 Wave, Shape, Mod Amount, Semitones, Fine Tune, Level °C
	18, 19, 20, 21, 22, 24	O	O	Oscillator 2 Wave, Shape, Mod Amount, Semitones, Fine Tune, Level °C
	48, 49, 51, 52, 25	O	O	Oscillator 3 Wave, Shape, Mod Amount, Semitones, Fine Tune, Level °C
	29, 30, 26	O	O	Noise Type, Color, Level °C
	27, 28, 71, 74, 83	O	O	Filter Type, Keytrack, Resonance, Cutoff, Drive °C
	73, 75, 70, 72, 79	O	O	Amp EG Attack, Decay, Sustain, Release, Velocity Sens °C
	85, 86, 87, 88, 84	O	O	Filter EG Attack, Decay, Sustain, Release, Intensity °C
	89, 90, 91	O	O	LFO1 Wave, Frequency, Smooth °C
	102, 76, 92	O	O	LFO2 Wave, Frequency, Delay °C
	98, 99	O	O	NRPN (LSB, MSB) °C
	103-108	O	O	Patch 1-6 Intensity °C
	12, 111, 112	O	O	MOD effect control 1-3 °C
	115, 13, 113, 114	O	O	DELAY effect control 1-4 °C
118, 14, 116, 117	O	O	REVERB effect control 1-4 °C	
95, 110, 94, 109, 93	O	O	EQ Low Freq, Gain, High Freq, Gain, Output Feedback °C	
Program Change		O 0-63	O 0-63	Bank select CC#0, CC#32, program change *P
	True Number	*****	0-63	CLASSIC A1-H8: 00, 00, 00-63 MODERN A1-H8: 00, 01, 00-63 FUTURE A1-H8: 00, 02, 00-63 USER A1-H8: 00, 03, 00-63
System Exclusive		O	O	*1, *E
System Common	Song Position	X	X	
	Song Select	X	X	
	Tune Request	X	X	
System Real Time	Clock	O	O	*2
	Commands	X	X	
Aux Meassages	Local On/Off	X	X	*3
	All Notes Off	O	O (123-127)	
	Active Sense	O	O	
	System Reset	X	X	
Notes				
*P, *C, *B, *E: This data can be received when the respective GLOBAL MIDI FILTER settings are set to "Enable".				
*C: The MIDI channel used for transmitting and receiving the timbre parameters for Timbre 2 can be set in Timbre 2 Channel.				
*1: Also supports device inquiry and master volume (receive only), aside from KORG exclusive messages.				
*2: This data is transmitted but not received when Clock Source of GLOBAL MIDI is set to "Internal"; and received but not transmitted when Clock Source of GLOBAL MIDI is set to "External USB/MIDI".				
*3: Transmitted when either Global Channel of GLOBAL MIDI, Timbre2 Channel or Routing settings are changed.				

Mode 1: Omni On, Poly  
Mode 3: Omni Off, Poly

Mode 2: Omni On, Mono  
Mode 4: Omni Off, Mono

O: Yes  
X: No

Consult your local Korg distributor for more information on MIDI Implementation.

# **KORG INC.**

4015-2 Yanokuchi, Inagi-City, Tokyo 206-0812 JAPAN

© 2024 KORG INC.

[www.korg.com](http://www.korg.com)  
Published 10/2024